



---

**Forschungszentrum Karlsruhe**  
in der Helmholtz-Gemeinschaft

---

**Wissenschaftliche Berichte**  
FZKA 7005

**MoDeSt Workshop  
on Recycling  
of Polymeric Materials  
3<sup>rd</sup> and 4<sup>th</sup> July 2003, Karlsruhe**

**Editors:**  
**A. Hornung, J. Schöner, H. Seifert**  
Institut für Technische Chemie

**April 2004**

**Forschungszentrum Karlsruhe**

in der Helmholtz-Gemeinschaft

Wissenschaftliche Berichte

FZKA 7005

MoDeSt Workshop  
on Recycling  
of Polymeric Materials  
3<sup>rd</sup> and 4<sup>th</sup> July 2003, Karlsruhe

Editors: A. Hornung, J. Schöner, H. Seifert

Institut für Technische Chemie

Forschungszentrum Karlsruhe GmbH, Karlsruhe

2004

**Impressum der Print-Ausgabe:**

**Als Manuskript gedruckt  
Für diesen Bericht behalten wir uns alle Rechte vor**

**Forschungszentrum Karlsruhe GmbH  
Postfach 3640, 76021 Karlsruhe**

**Mitglied der Hermann von Helmholtz-Gemeinschaft  
Deutscher Forschungszentren (HGF)**

**ISSN 0947-8620**

The MoDeSt – Workshop is a meeting of scientific, engineering, industrial, and administrative parties for special topics and problems related to the fields of the MoDeSt – Conference. It will be organised every two years in rotation with the Conference.

### **Aim of the Workshop on Recycling**

The aim of the “Workshop on Recycling of Polymeric Material” is a discussion of the state of the art technologies, experimental set-ups and numerical tools concerning recycling and thermal treatment of polymeric materials. Furthermore, clarification in applicability, needs and financial backgrounds of already realized and new developed techniques and strategies shall be obtained.

## **MoDeSt Society has the objectives:**

- promoting applied research in University laboratories, in public organisations and in companies;
- spreading scientific information;
- favouring teaching within the modification, degradation and stabilisation of polymers domain.

In particular, the association will try to encourage:

- communication and transfer of information between specialists of different scientific aspects of modification, degradation and stabilisation of polymers processes;
- the establishment of links between industry and public research laboratories;
- the acknowledgement of the importance of teaching, research and development in the modification, degradation and stabilisation of polymers domain;
- the stimulation of common projects or networks in this area;
- the cooperation with other national and international organisations involved in domains relevant to the modification, degradation and stabilisation of polymers.

## **Committees**

### **International Advisory Board**

N.C. Billingham (UK), G. Camino (I), A. Hornung (D), La Mantia (I), H. Seifert (D)

### **Local Committee**

A. Hornung, J. Schöner, H. Seifert

### **Workshop Office**

Stephanie Pressmann

Phone: +49 7247 82-2656

Fax: +49 7247 82-4373

e-mail: [modest.workshop@fzk.de](mailto:modest.workshop@fzk.de)

## Greeting

Dear participants, dear guests,

with great pleasure the Forschungszentrum Karlsruhe (FZK) will be the host for the “Workshop on Recycling of Polymeric Materials” this year in July.

“Recycling of Polymeric Materials” becomes an increasing challenge, because of growing consumption of those materials, which can be found in many waste fractions, like packaging material, electrical-electronic-equipments (EEE), automotive shredder residue (ASR) etc. For the waste management of these fractions already exist in some cases national as well as European regulations.

After waste avoiding the recycling of waste and the material recycling of some polymeric waste streams is a basic obligation. Beside this the energy recovery from waste, especially as alternative fuel, should not be neglected. The best individual way for the recycling of polymeric materials could be found with help of life cycle assessment studies (LCA) including ecological as well as economical aspects.

At the FZK thermal waste treatment is a main topic since more than fifteen years. Incineration of very different waste streams on the grate was deeply investigated particularly with respect to the emission control, especially for critical pollutants like dioxins and furans and to the partitioning of elements in the various residues of the process. In the meanwhile, also the rotary kiln technology is added in our research program, both as incineration- and as pyrolysis process. The latter plays an important part for the recycling of EEE-waste streams. Supplementary we started with investigations of pyrolysis/gasification combination processes for special wastes like biomass.

I hope that the coming workshop will be a full success for all of us and I invite you to visit our different groups at the FZK, working in the field of recycling of polymeric materials.

Prof. Dr.-Ing. Helmut Seifert

Institute for Technical Chemistry  
Thermal Waste Treatment Division  
Forschungszentrum Karlsruhe GmbH

# The city of Karlsruhe

Sunbeams inspired the Margrave Karl-Wilhelm of Baden-Durlach, when he planned the Karlsruhe Fan 1715 – streets and avenues fan out in all directions from the castle. The best view of the particularly impressive, uniquely clear ground plan is from the tower of the castle.

Since 1950 the two highest courts have been situated in Karlsruhe, the Federal Constitutional Court and the Federal Court of Justice. Thus, as the home of justice Karlsruhe is synonym for constitutional justice and democracy in Germany.

Karlsruhe has been a center of European research for years as a region of technology. Karlsruhe accommodates additionally to the Forschungszentrum the oldest Technical University of Germany and many other research and transfer institutions. Famous teachers have been in Karlsruhe, like Heinrich Rudolf Hertz (1857 – 1894), former professor for physics at the technical school, who discovered the electromagnetic waves or Fritz Haber (1868 – 1934), a nobel prize winner, who succeeded in the high pressure synthesis of ammonia.

## Forschungszentrum Karlsruhe

The Forschungszentrum Karlsruhe is a research institution founded jointly by its two partners, namely, the Federal Republic of Germany and the State of Baden – Württemberg. Being a member of the Helmholtz Association of National Research Centres (HGF), the Forschungszentrum Karlsruhe is one of the biggest science and engineering research institutions in Germany. Its research and development programs extend over areas of industrial precommercialization phase research, product and process development, provident research and fundamental scientific research. The Forschungszentrum Karlsruhe cooperates with partners in science and industry. Furthermore, it operates large-scale facilities also for external users.

## Links about Karlsruhe and the region

[www.karlsruhe.de](http://www.karlsruhe.de)

[www.fzk.de](http://www.fzk.de)

[www.karlsruhe.de/Tourismus/ukv/](http://www.karlsruhe.de/Tourismus/ukv/)

[www.uni-karlsruhe.de](http://www.uni-karlsruhe.de)

[www.maulbronn.de](http://www.maulbronn.de)

Informations about the city

Homepage of the Forschungszentrum Karlsruhe

Hotels and more

University of Karlsruhe

Maulbronn and the convent

# Lectures

## Mechanical Processing

### State of the art in processing, recycling and reuse of thermoplastics, thermosettings and contaminated materials

A1	Dipl. Ing. Holger Bös	DKR-Deutsche Gesellschaft für Kunststoffrecycling (D)
A2	Prof. Francesco Paolo La Mantia	Dip. Ingegneria Chimica Università di Palermo (I)
A3	Prof. Domenico Acierno	DIMP - University of Naples " FEDERICO II (I)

## Pyrolysis

### - Lab-, pilot- and technical scale approaches

B1	Dr. C. Gisèle Jung	Université Libre de Bruxelles (B)
B2	Prof. Tiziano Faravelli	Politecnico di Milano (I)
B3	Dr. Mariane Blazsó	Research Laboratory of Materials and Environmental Chemistry (HU)

## Gasification

### - Lab- and pilot-scale approaches

B4	Dr. Dietrich Meier	Bundesanstalt für Holzwirtschaft (D)
B5	Dr. Edmund Henrich	Forschungszentrum Karlsruhe, ITC-CPV (D)
B6	Henning Nannen	Volkswagen AG, Wolfsburg (D)
B7	Dr. Andreas Hornung	Forschungszentrum Karlsruhe
	Dr. Edmund Henrich	
	Prof. Thomas Kolb	

## Recycling and Flame Retardants

### - New approaches for a better recycling

C1	Prof. Giovanni Camino	Politecnico di Torino (I)
C2	Prof. Manfred Döring	Forschungszentrum Karlsruhe ITC-CPV (D)

## Fundamentals in Thermal Recycling

### - Database: evaluation, simulation and application

D1	Andreas Mäurer	GSF-Forschungszentrum für Umwelt und Gesundheit (D)
D2	Dr. Jürgen Vehlou	Forschungszentrum Karlsruhe, ITC-TAB (D)
D4	Dr. Ursel Hornung	Forschungszentrum Karlsruhe, IKET (D)

## WEEE - Industrial approaches, new technologies and principal studies

E0	Günther Albrecht	Ministerium für Umwelt und Verkehr Baden-Württemberg (D)
E1	Dipl.-Ing. Kai Kramer	Electrocycling Gosslar (D)
E2	Dr. Andreas Hornung	Forschungszentrum Karlsruhe ITC-TAB (D)
E3	Dr. Patrick van Schijndel	Technische Universiteit Eindhoven (NL)
E5	Seppe Geerinck	Umicore (B)



**LCA Studies**  
**Economic and ecologic studies in the field of recycling of polymeric materials**  
**- Needs, perspectives and critical factors**

F1	Prof. Liselotte Schebek	Forschungszentrum Karlsruhe, ITC-ZTS (D)
F2	Prof. Bruno De Benedetti	Politecnico di Torino (I)
F3	Mattias Olofsson	Chalmers University of Technology (S)
F4	Axel Kistenmacher	APME (B)
F5	Prof. Umberto Arena	Second University of Naples (I)

**Description of the workshops I and II:**

Workshop I: (Chair: Prof. Tiziano Faravelli)

Discussion of fundamental research techniques

- Experimental set-ups
- Evaluation of formal kinetic parameters
- Numerical simulation of thermal degradation
- Applicability of data and models

Workshop II (Chair: Dr. Andreas. Hornung)

Discussion of technical approaches reflecting technical, environmental and legislative requirements.

- Industrial needs
- Economic and ecologic aspects
- Network supports

**Title of presentations**

**Mechanical Processing**

**State of the art in processing, recycling and reuse of thermoplastics,  
thermosettings and contaminated materials**

- A1 State of the art of plastic packing recycling
- A2 On the use of natural organic materials as fillers for recycled post-consumer plastics
- A3 Mechanical recycling of polymer-clay nanocomposites prepared by melt compounding

**Pyrolysis**

**- Lab-, pilot- and technical scale approaches**

- B1 Interaction between wood and PVC during pyrolysis – chlorine capture: extrapolation from lab to pilot scale
- B2 Detailed kinetic modeling of thermal degradation of plastics
- B3 Thermal decomposition reactions of acrylonitrile-butadiene-styrene copolymer (ABS)

**Gasification**  
**- Lab- and pilot-scale approaches**

- B4 Fast pyrolysis for waste wood treatment
- B5 Gasification of Biomass – Agricultural residues to synfuel and power
- B6 SunFuel® - Fuel for future drive systems
- B7 Activities of the Forschungszentrum Karlsruhe; Thermo-chemical biomass conversion Techniques, field studies and applications

**Recycling and Flame Retardants**  
**- New approaches for a better recycling**

- C1 Fire retardants for sustainable development
- C2 Halogen-Free flame retardants in polymers

**Fundamentals in Thermal Recycling**  
**- Database: evaluation, simulation and application**

- D1 Investigations on the recycling of soft PVC and of technical polymers from electronic waste while eliminating plasticiser or brominated flame retardants and PBDD/F respectively
- D2 Energy and material recovery by co-combustion of WEEE and MSW
- D4 Evaluation of formal kinetic parameters concerning the gasification of bio-polymeric materials

**WEEE -**  
**Industrial approaches, new technologies and principal studies**

- E0 Directive on used electric and electronic equipment  
Directive on the restriction of use of certain hazardous substances in EEE
- E1 Reclaim of End-of-Life Electrical and Electronic Products by automatic sorting and grinding
- E2 Haloclean/Pydra – thermal chemical recycling of WEEE
- E3 Plastics from E&E waste: innovative separation and upgrading technology
- E5 Mobile phone recycling – the solution for the WEEE – directive

**LCA Studies**  
**Economic and ecologic studies in the field of recycling of polymeric materials**  
**- Needs, perspectives and critical factors**

- F1 Disposal of electronic scrap in Baden-Württemberg: A life – cycle view on future recycling options – outline of a study
- F2 LCA experience in the field of recycling of plastics from electronic waste
- F3 Decreased landfilling of waste in Sweden leading to a large expansion of waste incineration – what are the impacts on recycling of polymeric materials?
- F4 Ecoefficient recovery options for plastics from cars
- F5 The environmental performance of alternative plastic waste recycling options. A LCA study

# PAPERS



## **Mechanical Processing**

### **State of the art in processing, recycling and reuse of thermoplastics, thermosettings and contaminated materials**

Authors: Dipl.-Ing.Holger Bös and Dr. Andreas Thiele

#### **Legal Situation**

The German Packing Ordinance of 1991/1998 aims at preventing, reducing and recycling packaging waste. Manufacturers and fillers of packaging as well as retailers and importers of packaging are obliged to take back and recycle packaging waste. This responsibility, however, may be transferred to a system which takes back waste packaging on a nationwide basis. Starting in 1991, "The Green Dot - Duales System Deutschland AG" (DSD) has established a "dual" system for the collection, sorting and recycling of used sales packaging from households. The Dual System is financed by the license fees paid by the manufacturers, fillers and retailers. The fees cover all costs for collection, sorting and recycling. In return, licensees may use the Green Dot on their packaging.

The Amendment to the German Packaging Ordinance of 1998 requires that certain amounts of used sales packaging are recovered for recycling. 60 percent by weight of the plastic sales packaging licensed within the DSD have to be recovered for recycling. Of this amount, again 60 percent (or 36 Percent of the licensed quantity) have to be forwarded for mechanical recycling. The remainder may be recycled with mechanical or feedstock techniques or forwarded for energy recovery.

#### **The Role of Recycling Guarantors in Germany**

The DSD is responsible for the collection and sorting of used sales packaging. The recycling is organised by so-called guarantors. Founded in 1993, the Deutsche Gesellschaft für Kunststoff-Recycling mbH (DKR) is sole guarantor of DSD for the proper recycling of plastic sales packaging with the Green Dot. In this function, the DKR has to secure that recycling targets are met (ensuring recycling reliability). Its basic task is to control, monitor and document the recycling from accepting the sorted packaging through the marketing of the recycling products.

At the outset of DSD and DKR only little capacities were available for the recycling of plastic sales packaging. Only a few recyclers had gathered experience with the recycling of plastic waste from industrial production processes. Recycling capacities and techniques for packaging waste, however, have been developed and improved with DKR support in the course of the last decade. Today, DKR contract-partners represent the state of the art in mechanical and feedstock recycling of used plastic sales packaging.

In the early nineties, the German packaging waste recycling was tainted by partially severe acts of fraud which harmed the public confidence in the separate collection of packaging waste. Highly subsidised, yet not sufficiently controlled "partners" promised to recycle the material properly. Some companies, however, simply sold the mixed plastic packaging-waste without any processing to European or less developed countries.

Due to these cases of fraud, the DKR has set new standards of monitoring of waste streams. Based upon its research & development activities as well as its monitoring system, it has improved the technical qualities of recycling.

### Input Into Mechanical Processing

DKR stands for the well-devised recycling mix of mechanical and feedstock-recycling ways. Due to the fact that plastic sales packaging does not contain any hazardous fill goods, recycling products made from this material are not contaminated. Other contraries and residues such as metal or paper in the material stream are sorted out in the sorting-plants which deliver the following fractions:

“films”,  
“bottles”,  
“cups/tubs”,  
“expanded polystyrene” and  
“mixed plastics”

DKR distinguishes between sorting techniques, refining and recycling processes. Pre-sorting is completed once DKR-partners accept the input-material delivered by the pre-sorting-plants.

### Products of Mechanical Processing

To guarantee the fulfilment of the targets set by the Packaging Ordinance, the DKR must forward 36 percent of the plastic packaging, licensed within the DSD to mechanical recycling. Recycling is considered completed once the recycler has produced and successfully marketed finished products or granules of typical polymers such as Polyethylene of-High Density (PE-HD) or Polyethylene Low-Density (PE-LD) Polypropylene (PP), Polystyrene (PS) or blends of these plastic-types. One typical significant product is the so called Polyolefine-Blend (PO) which is a mix of PE-LD, PE-HD and PP of fluctuating composition.

Some recyclers use synergy-effects by immediately producing thermoplastic goods. These plants remelt thermoplastic materials right after the washing-process into injection moulding products, e.g. transport pallets.

### Typical Mechanical Treatments of Waste

In different ways, all DKR-recycling partners developed and implemented their individual recycling concept, in which the following elements are combined differently depending on the input-fraction and the output-target:

- Post-sorting by article and or type of plastic (if not sufficiently provided by the collector/pre-sorter)
- Grinding and/ or other homogenising of the material
- Dry cleaning and dry separating units are:
  - Ferro-magnetic or allmetal-detector combination crossover a conveyer-belt.
  - Near-Infrared or Colour-Identifier by optical sensor and extracting by pneumatics
  - Sifting units with different shape, movement, mash-width and sensitivity
  - drying, pulverisation and removing of adhesive dirt by friction or impulse,
  - separating of “thick from thin” pieces by means of airfluid
- Washing and wet-separation by means of natural or artificial gravity in different liquids
- Extruding, devaporising, preparation of non-melting residues, compounding and injection-moulding of technical parts or intrusion of bars and thick-walled parts.
- Surface-laminating and refining technologies to improve appearance and performance against weather or increase market-acceptance.

### **Shares of Different Input-Fractions**

In 2002, 20 percent of the material accepted by DKR consisted of films (containing more than 50 percent PE-LD), 18 percent were bottles (containing approx.40 percent PE-HD and approx. 50 percent PET) and 2 percent were cups/tubs and EPS. Mixed plastics accounted for 60 percent.

### **State of the Art of Mixed Plastics Recycling**

Most of the material accepted by DKR as mixed plastic (~300.000t per year) is mechanically refined into a so-called mixed plastic agglomerate. That is not a recycled product, but a so called intermediate product. The further use of that material must still be controlled by DKR.

It must provide very low contents of PVC and inerts.

The agglomerate is nearly entirely recycled in feedstock recycling plants: Steelworks use plastic agglomerate as reducing agent instead of heavy oil or coal dust to produce pig iron from iron ore. At the Sekundärrohstoff-Verwertungszentrum Schwarze Pumpe (SVZ) agglomerate is processed into synthesis gas which is used as starting material to generate methanol. Though preparation for feedstock recycling seem to require only relatively little refining, costs for this recycling outlet are high. Accordingly, efficient cost reductions in this area have to be accomplished.

### **State of the Art of Film (PE-LD) Recycling**

For recycling sorting plants extract films bigger than DIN A4-size (=21 cm x 29.7 cm). This is reached by sifting and additional floating in air stream separation. The final sorting product is usually monitored manually. The capacity for the recycling of film into extruded granules is approximately 120.000 t in Germany. The extruded granules are also used for film or blow mould extrusion or injection moulding.

Typical process steps are: shredding, pre-washing, grinding friction washer, flotation or other dividing by density methods above or below the density of the floating medium, for which water is generally used. After the floatation the target fraction is dried mechanically by centrifugal force and thermally by hot-air-pipe transport to the extrusion unit. The main share of film products are granules. Control of recycling by the guarantor (DKR) ends, once the granules are marketed successfully.

In concluding the description of film recycling from household collections, we find relatively expensive sorting and washing processes due to the difficult handling of soft material with low bulk density. A high selling price for extruded R-PE-LD granules, however, makes it possible that even non-subsidied industrial quality-recyclers can survive in the market.

### **State of the Art in Mechanical Bottle-Processing**

Compared to ground flakes from film, the bulk density of ground material generated in the bottle recycling process is higher. As a result, higher through puts are reached in the grinding and washing process. In addition, the extrusion process can be conducted more easily because of easier feeding of the extruders.

Being collected and sorted as mixture of completely different kinds of plastic (PE, PET and some PP) the bottle fraction has to be separated by plastic kind into PE-HD, PP and PET in different colour combination. DKR has installed four sorting centres for this purpose with an annual capacity of 60.000 ton of bottle resorting and processing.

The easy washing and recycling process of thick-walled, stiff PE-HD flakes would practically not need any further control, because PE-HD flakes can be sold profitably. The current packaging waste treatment regulation, however, requires that ground material must not be accepted as fully recycled by DKR. Accordingly; processing at recycling plants includes the extruding and compounding of PE-HD. The granules are especially used for extrusion such as pipe-extrusion or as add-on compound for big blow-moulding parts like rain-water-container or similar pieces with high scheme of material cost.

The European recycling capacity for PET-bottles is more than 400.000 tonnes per year Compared to 2,1 Mio. tonnes of PET blow-mould containers put into the market in Western Europe each year this recycling capacity seems to be relatively underdeveloped. In 2002, DKR forwarded 60.000 tonnes PET-bottles for mechanical recycling.

### **Recycling Cost are Dropping**

Compared to 1996, the DKR has reduced the cost for recycling for almost 40 percent. The costs which cover the expenses for recycling, processing, transport and storage amounted to around 278,-€/t or around 0,28 €/kg in 2001. In 2002, further cost reductions were accomplished. The DKR's strategic goal is to improve the eco-efficiency in plastics recycling which means to even further reduce the costs to the level of conventional waste disposal like incineration or landfilling by 2006. At the same time, the current ecological benefit of plastic recycling is to be enhanced.

### **Outlook on the Feedstock Recycling and Energy Recovery From Plastic Packaging Waste**

Both processes require a qualified refining according to the input specifications of the recyclers. Especially with regard to the portion of PVC or other ingredients that interfere with the simple substitution of oil or charcoal in feedstock or energy recovery processes, the plastic packaging waste has to undergo dry refining, friction-cleaning for label-paper-destruction, and paper extraction by air floating principle.

In case of questions or for further information, please feel free to contact DKR:

Holger Bös  
Projectmanager Technical Customer Services  
Tel: +49 (0)2203 9317 806  
Fax: +49 (0)2203 9317 700  
[http:// www.dkr.de](http://www.dkr.de)  
email: boes-dkr@t-online.de

or

Dr. Andreas Thiele  
Head of Department Technical Customer Services  
Tel: +49 (0)2203 9317 728  
Fax: +49 (0)2203 9317 700  
[http:// www.dkr.de](http://www.dkr.de)  
email: andreas.thiele@dkr.de



# **On the use of natural organic materials as fillers for recycled post-consumer plastics**

F.P. La Mantia, N. Tzankova Dintcheva, M. Morreale

Dipartimento di Ingegneria Chimica dei Processi e dei Materiali  
Università di Palermo, Viale delle Scienze, 90128 Palermo, Italy

## **Abstract**

Addition of organic fillers to post-consumer recycled plastics can give rise to several advantages. First of all the cost of these fillers is usually very low, the organic fillers are biodegradable contributing to an improved environmental impact and, finally, some mechanical and thermomechanical properties can be enhanced. Organic fillers are not widely used in the plastic industry although their utilization is increasing. Bad dispersion into the polymer matrix at high level content and a poor adhesion with the matrix are the more important obstacle to this approach.

In this work different organic fillers have been used in two different post-consumer plastic materials. The properties of the organic fillers composites have been compared with those of materials filled with inorganic fillers. The organic fillers cause an enhancement of the rigidity and of the thermomechanical resistance similar to that measured for the inorganic fillers while a reduction of the impact strength is observed. The use of compatibilizers can improve this behavior.

## **Introduction**

The first fillers studied and utilized for polymer-based composites were basically inorganic. The main reason which led to their use was the need for cheaper materials or for a significant improvement of some properties (rigidity, resistance to the temperature, etc.) of the polymer matrix [1]. A new series of fillers has been recently investigated: the organic ones.

There is a number of reasons suggesting the use of these fillers for composites: low cost, environmental issues (organic fillers are biodegradable, they come from renewable sources giving rise to less concern about their disposal), lower hazard to the health of the operators, low specific weight in comparison to mineral filler, etc. [1-6].

According to literature data, several kinds of polymer-organic filler composites have been studied in the last years, especially based on commodity polyolefin matrices. Polyethylene has been studied in combination with wood fibers and wood flakes [7, 8], corn starch [9,10], potato starch [9], sago starch [11,12], sisal fibers [3], or kenaf fibers [13]. On the whole, an elastic modulus increase has been observed – increase of the rigidity - while the properties at break usually decrease – reduction of the ductility.

The possible use of natural-organic fillers with post-consumer recycled plastics has been considered by several researchers. In particular, great interest exists about the use of organic fillers with recycled thermoplastic polymers, because of the increasing, widespread concern about ecology and environment, but also the industrial needs for lower costs. Furthermore, thermoplastic materials reinforced with natural fillers present mechanical properties similar to the ones added with inorganic fillers (like, for instance, talc and calcium carbonate) but with lower density, less harmful to the health, low abrasiveness, good acoustic- and thermal-insulating properties and, of course, partial replacing of a non-biodegradable polymer with a biodegradable filler [14-16]. Cellulose fillers have been added to thermoplastic polymers [17-20] and in all these cases, stiffness increases as the amount of fibers added to polymer matrix increases. The main problem faced in these studies concerns the dispersion of fibers within the matrix and the poor adhesion between polar fibers and non-polar matrix.

Selke [21] investigated the effect of addition of wood fibers (polar) to high-density polyethylene (HDPE), the latter coming from food package, while Simpson [22] and Oksman [23] studied the effect of addition of the same wood fibers to a polypropylene matrix, PP, coming from ketchup bottles.

A study by Yam et al. [24] showed that incorporation of aspen wood fibers to HDPE blends, coming from milk bottles leads to a significant increase of tensile modulus and flexural modulus, and a better resistance to creep. However, tensile strength and impact strength is lower than the ones of unfilled HDPE. Wood fibers can be added up to 40-70% by weight or 80% by volume [25,26].

The problem of fillers dispersion within the polymeric matrix has been faced by Park [27] and Liao [28] through recycling thermoplastic polymers in two different processing apparatuses, a batch mixer and a single-screw extruder. Better results have been achieved by the extruder, maybe because of a better homogenization of the material components. Unfortunately, the problem of matrix-fibers compatibilization is much more difficult to be studied and solved, furthermore it has been mainly investigated just for virgin polymer

matrices. For fiber filled HDPE case [21], two kinds of compatibilizers have been used: polyethylene ionomers (PE-IO) and maleic anhydride-grafted polypropylene, MA-g-PP. On the other hand, for the fiber filled PP [22], maleic anhydride-grafted polypropylene, MA-g-PP, maleic anhydride-grafted styrene-ethylene-butadiene-styrene rubber, MA-g-SEBS, and a maleic anhydride-grafted ethylene-propylene-diene copolymer, MA-g-EPDM have been used. All the additives improved both mechanical and morphological properties of the materials.

MA-g-PP added to sawdust-recycled PP composites has been successfully tested by Li et al. [27], with regard on the impact resistance, and it has been observed that the notched Izod strength tends to increase with the filler content, while, without MA-g-PP additive, the Izod strength decreases with the filler content and is always lower than the strength of the resin. Other modifiers which have been kept in consideration are: EPDM, SEBS and EVA; Oksman and Clemmons [28] studied the modification they caused to virgin polypropylene-fibers surface tension.

On the whole, natural organic fibers are environmentally-friendly fillers, and in conjunction with recycled plastics allow to obtain low-cost materials with properties good enough for applications like interior car parts, plastic lumber, window and door frames, gardening items, paddocks, road signs, casing, packaging and in general for every application which does not see very high stresses [ 18-20, 29].

In this work, the effects of the addition of different organic fillers on the mechanical and rheological properties two different post-consumer plastic materials have been investigated. The organic fillers come from natural sources (wood, kenaf, sago) and have been compared to glass fibers and calcium carbonate.

The addition of organic fillers to the post-consumer plastic matrices causes an enhancement of elastic modulus (and therefore of stiffness) and of the thermomechanical resistance, while a reduction of tensile strength and elongation at break is observed. Although in some cases the inorganic fillers give rise to a best enhancement of the overall performances of the plastic matrix, organic fillers may be considered as valid substitutes. In particular, very cheap fillers such as sawdust and olive stones filled materials show appreciable properties. To achieve better properties compatibilizers are needed in order to improve filler dispersion and interface adhesion between filler and matrix.

## Experimental

Two different post-consumer plastics have been investigated.

The post-consumer films for greenhouses, RPE, have been collected in the province of Ragusa (Sicilia, Italy, where the most important production of covered cultivation is located). The recycled polymer contains LDPE (65-75%), LLDPE (10-15%) and EVA (10-12%). Small amounts of inert fillers and UV stabilizers (about 2500 ppm) are also present (30).

The second material, LF, comes from separate collection of plastic municipal waste. As already said, the light fraction was prepared starting from separated plastic collection of municipal waste and next separation by flotation in water. After densification the mixture is in the form of small pieces of different size. The composition is about 80% of polyethylenes and 20% of polypropylene, determined by FITR. Small amounts, 0.3-0.5% of other polymers heavier than water, PET, PVC and PS, are also present; the amount of PVC was about 0.1-0.15% determined by XRF (X-Ray Fluorescence). The material contains also small amounts, less than 1%, of impurities like paper, aluminium, etc. (31).

Two different functionalized PP samples were used to enhance the adhesion between matrix and fibres. The first sample is a maleic anhydride grafted polypropylene (PP/MA), Qestron KA 805, manufactured and kindly supplied by Montell (Italy). The melt flow index is about 80 and the concentration of functional groups is about 0.7% wt/wt. The second sample is an acrylic acid grafted polypropylene (PP/AA), Polybond 1001, manufactured and kindly supplied by Uniroyal Chemical. The melt flow index is 40 and the concentration of functional groups is about 6% wt/wt.

Four different organic fillers were used to prepare the filled polymers: sago starch, SS, olive stones, OS, wood fibres, WF, and sawdust, SD.

Sawdust was obtained by milling wood in a blade mill through two different mesh grid, in particular and mesh corresponding to two fractions:  $SD_c$  ranging from 0.25 to 1 mm and the other one,  $SD_f$ , in the range 0-0.25 mm.

Sago starch is extracted from the trunk of a number of palms, first of all the *Metroxylon Sagus*, coming as white-like granules. The filler has an average particle size of 20  $\mu\text{m}$  and a decomposition temperature of about 230 °C [12].

Wood fibres, kindly supplied by Isoroy (France), are produced by thermomechanical pulp from softwood. The concentration range of wood fiber has been taken in the same range used in all studies with the same filler. Both length and diameter are highly variable, ranging

between about 20-80 mm the diameter and the length-to-diameter ratio from about 20 to about 150.

Olive stones (OS) are produced from the residues of the olive oil production. After extracting the olive oil, there is a residue of pulp and stone mixed with water. Water is evaporated and the solid residue is hexane-extracted to recover the remaining oil. After drying, the solid residue is separated in pulp and stone. The residue of stone has been ground to particle of about 315  $\mu\text{m}$  average size. The chemical composition is about 8% lignin, 26% hemicelluloses and 66% cellulose (32).

For comparison, some tests were also carried out by using E-type glass fibers, GF, produced by Vetrotex, 10  $\mu\text{m}$  diameter and length-to-diameter ratio of about 450 and calcium carbonate, Omya 2T-UM, 10  $\mu\text{m}$  average diameter and coated with stearic acid for a better adhesion.

The processing of LF with wood fibers was carried out in a single screw extruder (L/D = 25, D = 19 mm). The thermal profile was 120, 160, 170, 180  $^{\circ}\text{C}$  and the screw speed 40 rpm. To avoid that the non-polymeric heterogeneities were extruded with the plastic mixture a close filter was inserted in the head of the extruder. Filled samples contained 20 and 40% wt/wt of wood fibers and 2- 10% of functionalized PP.

The RPE composites were prepared with two different compositions, namely 30% and 60% (by weight) of filler by using a corotating intermeshing twin screw extruder (OMC, Italy, d = 19 mm and l/d = 35 ) was running at 200 rpm and with a thermal profile of 120-130-140-150-160-170-180  $^{\circ}\text{C}$ .

The specimens of filled LF were prepared by both compression molding using a Carver laboratory press at 180 $^{\circ}\text{C}$ . The RPE composites were prepared by injection molding using a Sandretto machine (Italy). In this study the processing parameters for all blends were set using typical conditions for LDPE: Melt temperature: 190 $^{\circ}\text{C}$ , Nozzle temperature: 190 $^{\circ}\text{C}$ , Mold temperature: 30 $^{\circ}\text{C}$ , Screw speed: 300 rpm.

The tensile properties were measured with an Instron universal testing machine model 4443. The crosshead speed was 5 mm/min and the initial length was 30 mm.

The impact strength has been evaluated on notched samples in Izod mode using a CEAST(Italy) apparatus model 6545.

HDT values were determined following ASTM D 2990-77(flexural load 1.8 MPa, rate of increase of the temperature 120  $^{\circ}\text{C}/\text{h}$ ) using an automatic CEAST apparatus.

For all the tests at least seven specimens were tested. The experimental data were quite reproducible ( $\pm 8\%$ ) for the composites up to 40% of fillers, and better for the pure recycled polymer, while the reproducibility was less good ( $\pm 10-12\%$ ) for the more filled samples, maybe because of a poorer filler dispersion within the matrix.

Rheological properties of LF materials were measured using a rotational rheometer Rheometrics RDA II in a plate-plate mode and a capillary viscometer CEAST Rheoscope at a temperature of 180 °C.

## Results and discussion

### *Wood fibers filled LF.*

Fig. 1 plots the mechanical properties of the unfilled light fraction and of the same material filled with 20% of the three fillers. The effect of the three fillers is quite similar for tensile strength, elongation at break and impact strength. In particular tensile strength and impact strength show values similar to those of the unfilled material, whereas the elongation at break is significantly lower. On the contrary, the elastic modulus increase with the filler and wood fibers and, in particular, glass fibers show the best results. The addition of 20% of glass fibres doubles the value of the elastic modulus of the unfilled polymer mixture.

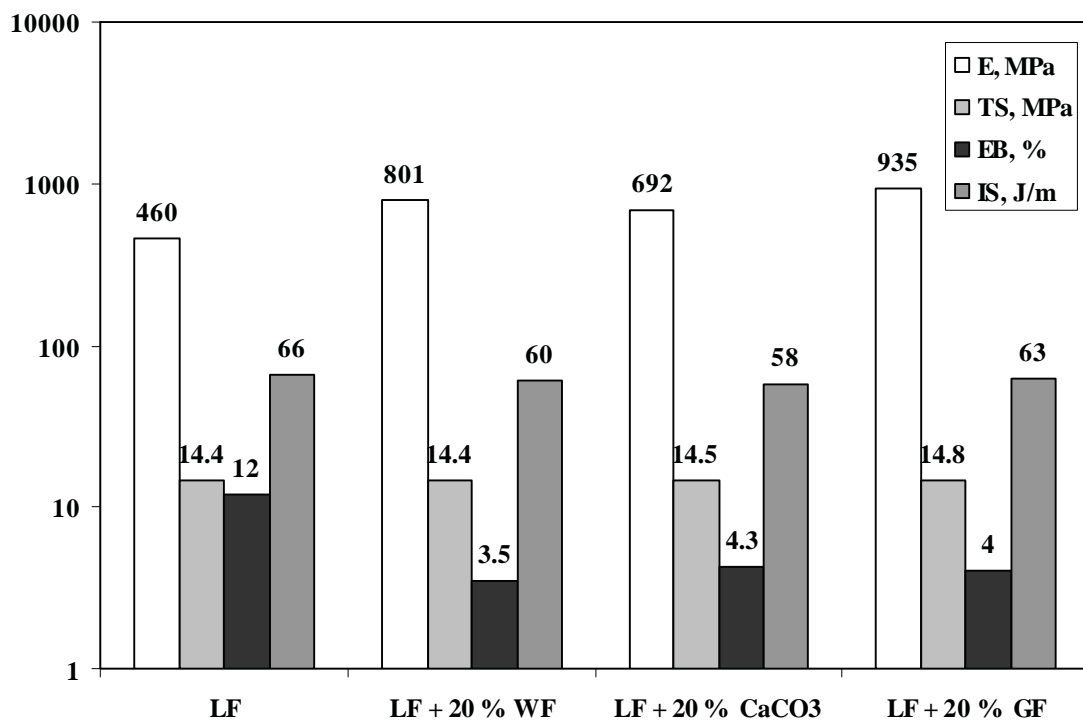

**Fig. 1.** Mechanical properties of the unfilled and filled plastics “light fraction”, LF

The addition of inert fillers strongly improves the rigidity of this plastic waste mixture, whereas the reduction of the elongation at break does not infirm the possible applications of this system in injection molding. The flow curves plotted in Fig. 2 show similar results: the larger increase of viscosity is given by glass fibers and the lowest one by the calcium carbonate. These results can be interpreted both on the basis of the intrinsic properties of the inert fillers and considering the geometry of the three fillers. Calcium carbonate is in the form of small spherical particles, whereas the other two fillers are in the form of fibers. It is well known that the longer is the length-to-diameter ratio of the particles the higher is the improvement of the mechanical properties.

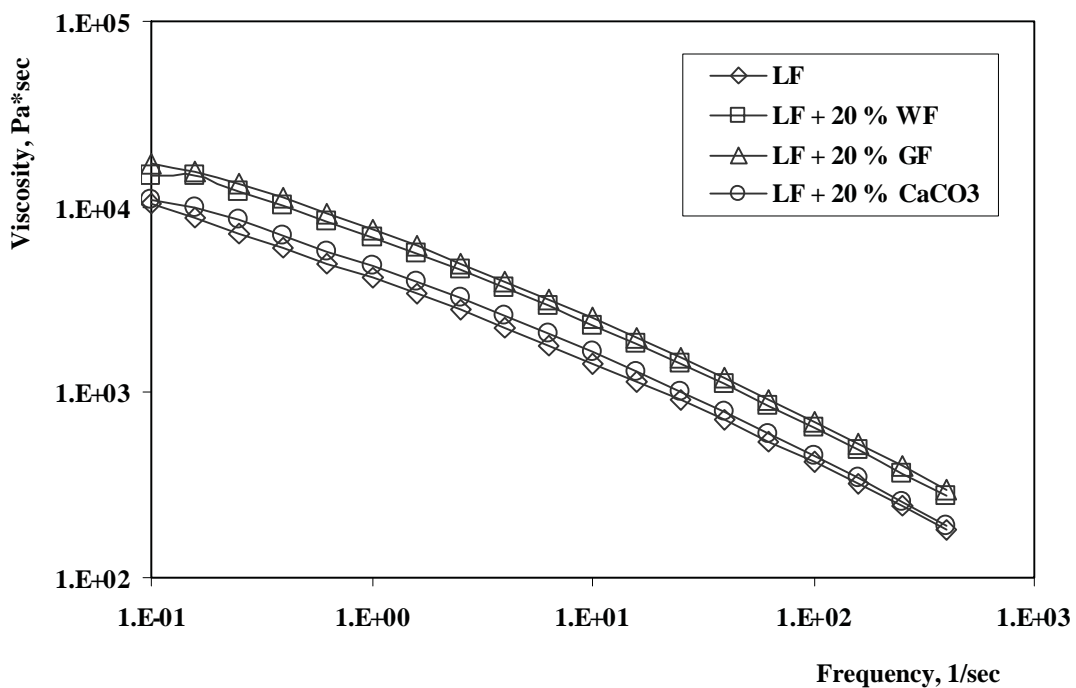
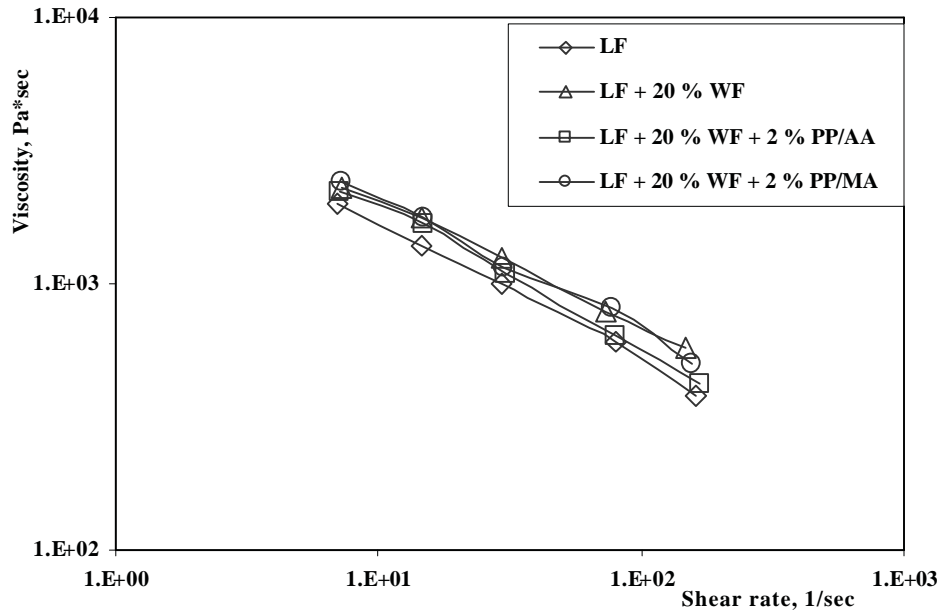

**Fig. 2.** Flow curves of the unfilled and filled plastic “light fraction”, LF

As reported in the experimental section, the L/D aspect ratio of GF is quite homogeneous, whereas that of the WF is highly variable. The mechanical stress breaks the fibers and the final L/D ratio for GF is about 100-200. The measurement of the length of the wood fibers after processing is much more difficult. Indeed, the fibers cannot easily separated and are strongly glued each other. The final length seems to be no more than 3-4 mm and than the maximum L/D aspect is only about 30-50.

The effect of the presence of the compatibilisers on the rheological behavior of this mixture with 20% of wood fibers can be observed in Fig. 3 where the flow curves are reported. The raw material shows a relatively high viscosity and a significant non-Newtonian

behavior. The presence of the two functionalized PP samples tends to increase the viscosity of the wood fibers filled LF but this effect is small due, probably, to some small enhancement of the polymer/wood fibres adhesion in molten state. Similar comments can be made on the flow curves of the material filled with 40% of wood fibers.

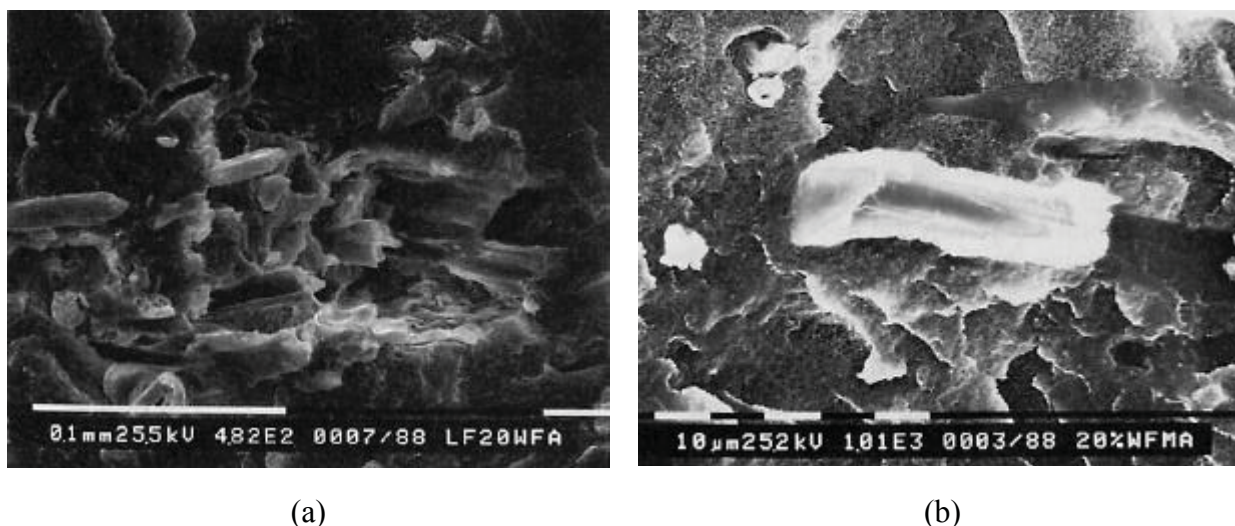

**Fig. 3.** Flow curves of all the samples

The wood fibers are quite well dispersed in the matrix, see SEM micrograph of the sample with 20% of wood fibers reported in Fig. 4a, but the adhesion is scarce and some voids are observed probably due to the pulling out of the fibers. The small particles scarcely adherent to the matrix are mostly the dispersed PP particles and the other heterogeneities.

The adhesion between matrix and wood fibres is slightly enhanced by the presence of the modified PP as observed in Fig. 4b where the SEM micrograph of the sample with 20% of wood fibres and 5% of PP/MA is reported. The fibres seem better anchored to the matrix with respect to the sample without adhesion promoter, but some voids are still present suggesting that the adhesion is not completely performed.





**Fig. 4.** SEM micrograph of the sample with (a) 20 wt% WF and (b) 20 wt% WF and 5 wt% PP/MA.

The mechanical properties as a function of the filler content for the investigated samples are reported in the Figs. 5-8. The addition of the filler gives rise to a remarkable increase of the rigidity of the material, in particular the modulus increases of about four times by adding 40% of WF and the tensile strength remains almost constant, while a significant decrease of the elongation at break and impact strength is observed. It is however to notice that the reduction of the elongation at break is not dramatic from a technological point of view because all the materials are quite fragile and there is not any change of the type of application for this decrease.

The addition of small amounts of functionalized PP improves the performances of the wood fibres and indeed all the mechanical properties show a significant enhancement. Only exceptions to this general behaviour are given by the slight decrease of TS for both functionalized PP at larger content and of EB when PP/AA is added at low concentration. It is interesting to notice that the best results are observed when very low contents of the functionalized sample are added.

The inert filler remarkably improves also the thermomechanical resistance of these low melting point polyolefins. In Fig. 9 the HDT values are reported as a function of the WF content. The HDT value of the light fraction is near to that of PE (about 50 °C) and lower than that of PP (about 70 °C in these experimental conditions). The HDT value increases remarkably with the WF content and reaches 70 °C with 40% of wood fibres. On the contrary, no significant modification of the HDT by adding the functionalized PP samples is observed.

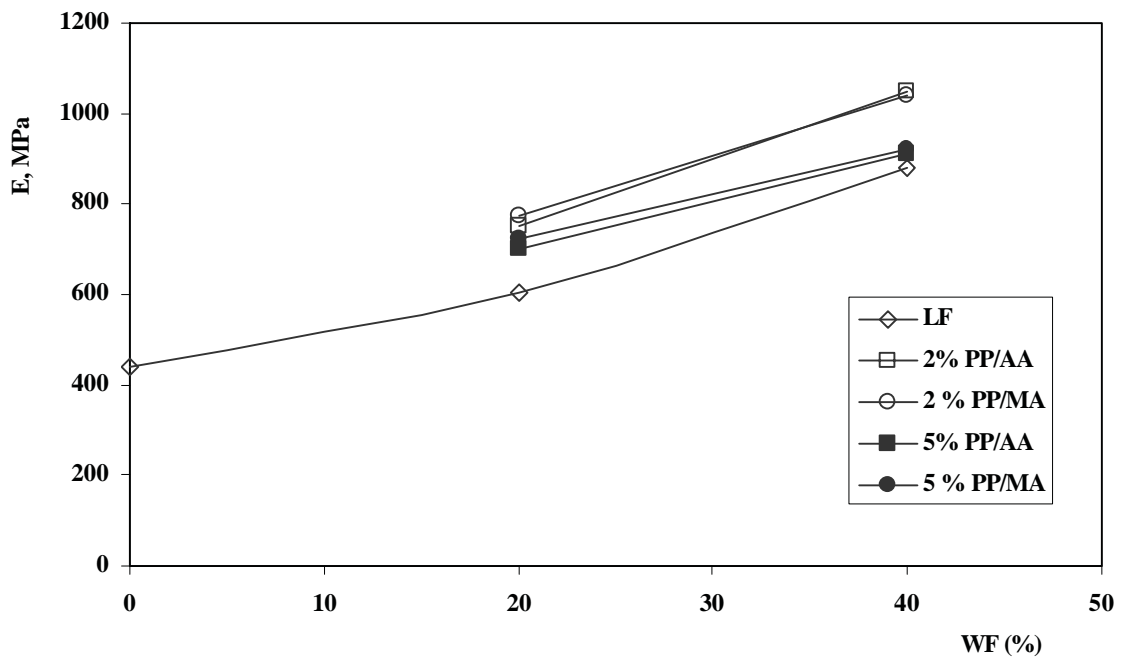

Fig. 5. Elastic modulus as a function of the wood fibers content and of the presence of the adhesion promoters

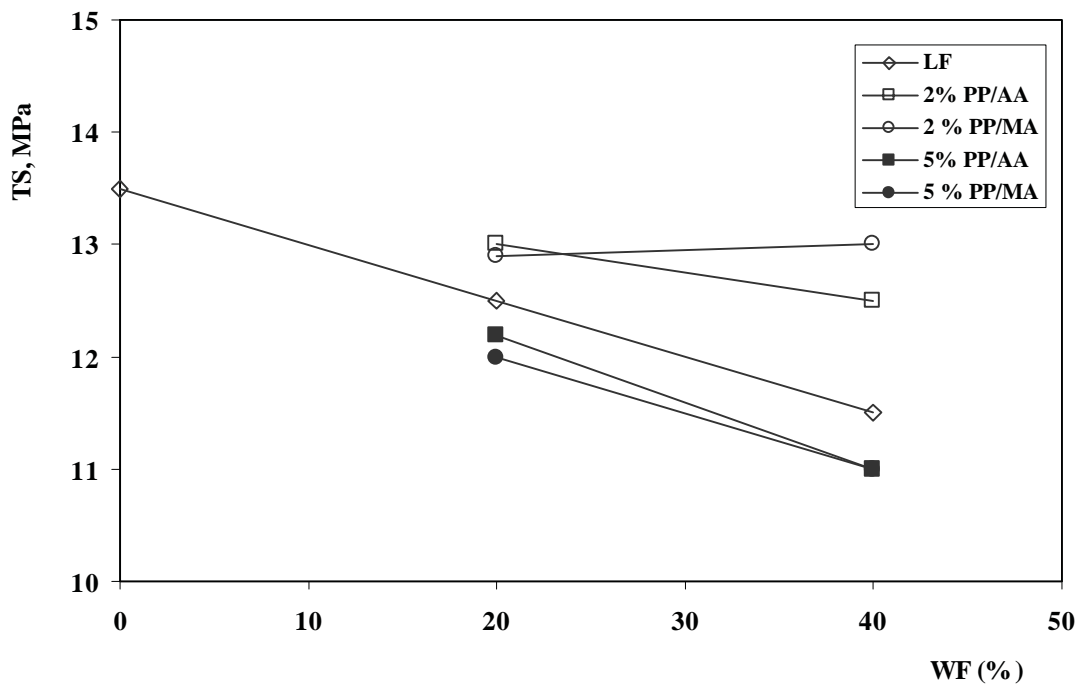

Fig. 6. Tensile strength as a function of the wood fibers content and of the presence of the adhesion promoters

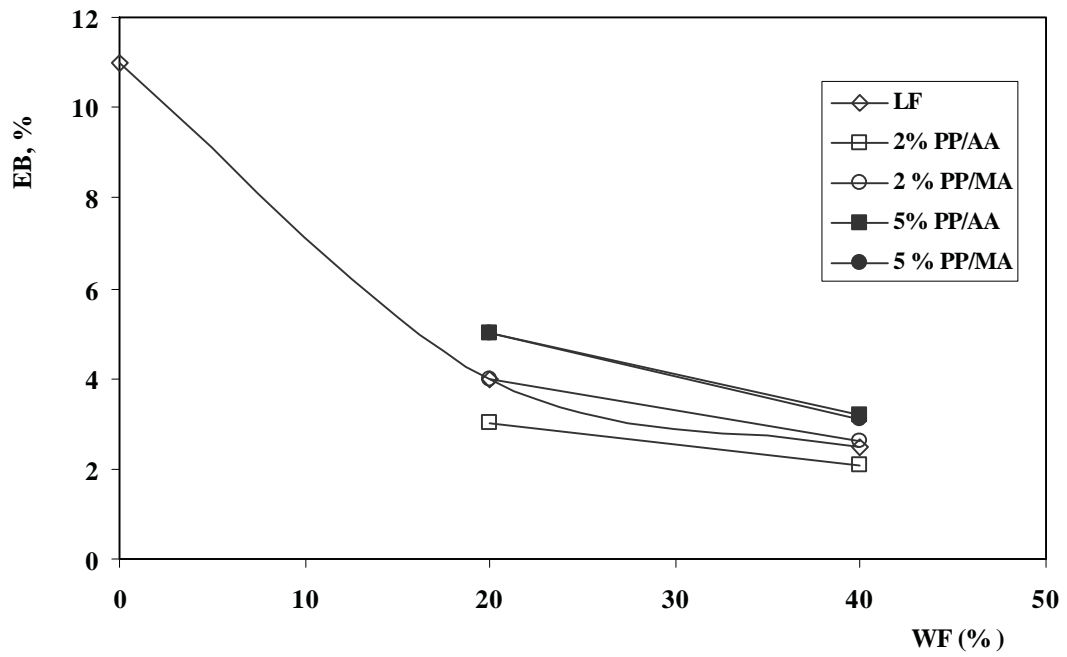

Fig. 7. Elongation at break as a function of the wood fibers content and of the presence of the adhesion promoters

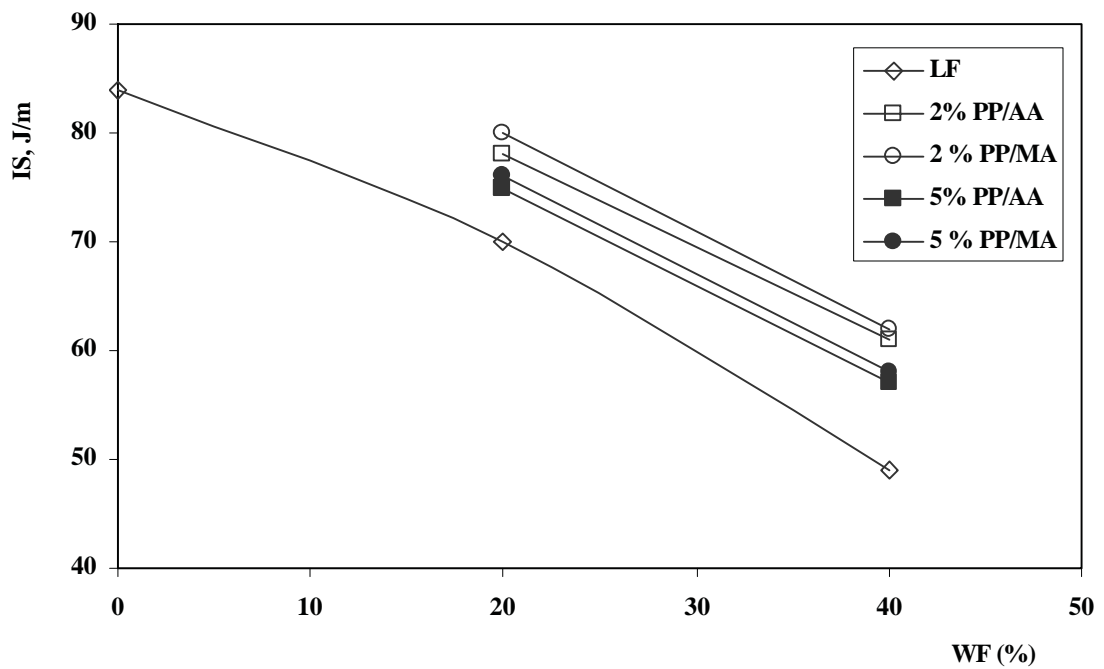
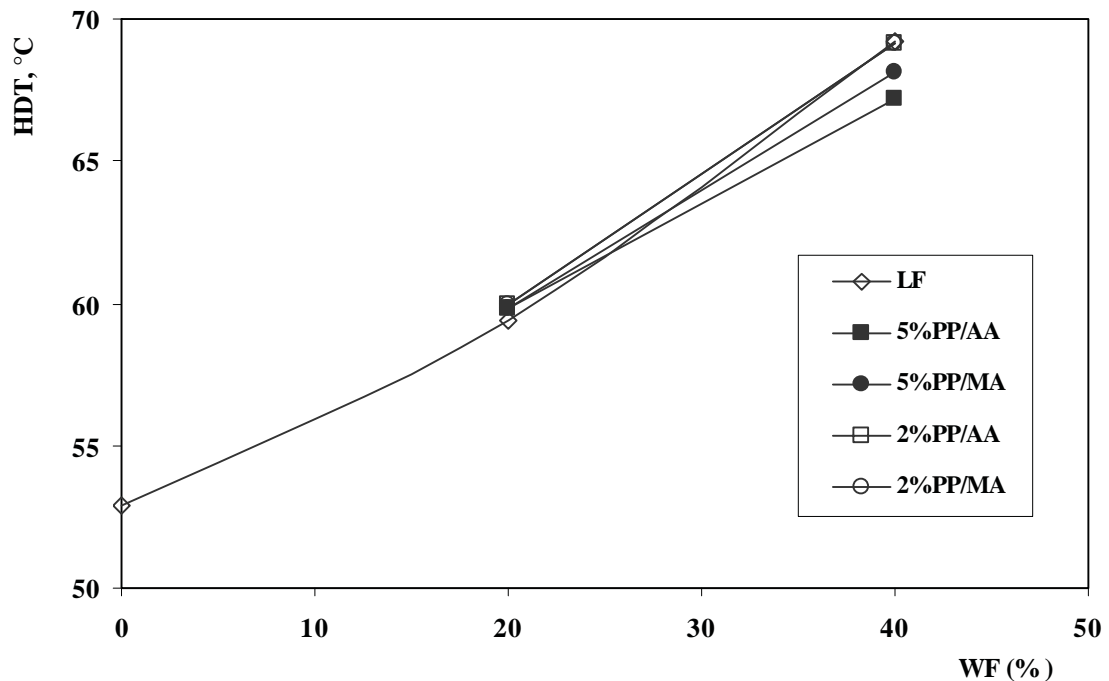

Fig. 8. Impact strength as a function of the wood fibers content and of the presence of the adhesion promoters



**Fig. 9.** HDT values as a function of the wood fibers content and of the presence of the adhesion promoters

*Post-consumer greenhouses films*

The values of the tensile properties (elastic modulus, E, tensile strength, TS, and elongation at break, EB) are plotted in the Figs. 10-12 as a function of the filler content for all the samples.

All the filled systems show some degree of stiffening - increasing with the filler content - and, as a consequence, the material becomes more and more fragile: indeed, the organic filler presence causes an increase in elastic modulus, whereas a decrease in tensile strength and elongation at break is observed. This picture is quite different for the composite with the inorganic filler. In this case an increase of the tensile strength has been revealed.

In Fig. 13 typical stress-strain curves for three samples are reported. The three curves clearly evidence that the initial slope is higher and that the decrease of the tensile strength for the organic filled samples is to attribute to the brittleness of the filled samples, indeed, the premature rupture of the sample causes a lower value of the stress at break. On the contrary, the sample filled with  $\text{CaCO}_3$  shows a similar slope but a slightly larger elongation at break and a consequent higher stress at break.

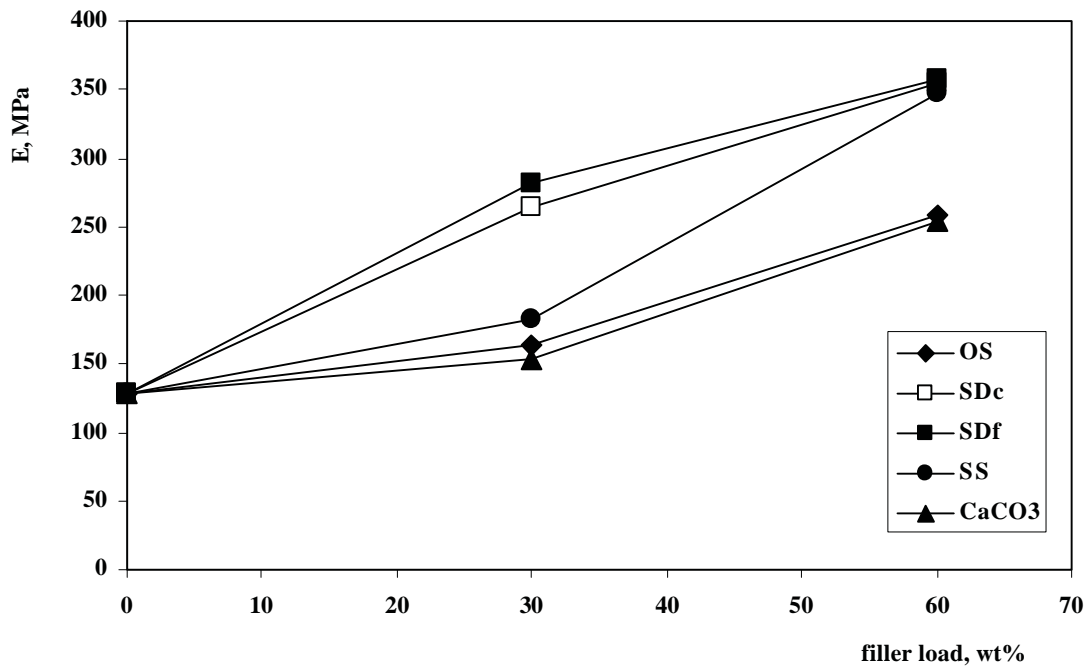

Fig. 10. Elastic modulus as a function of the filler content for injection molded samples

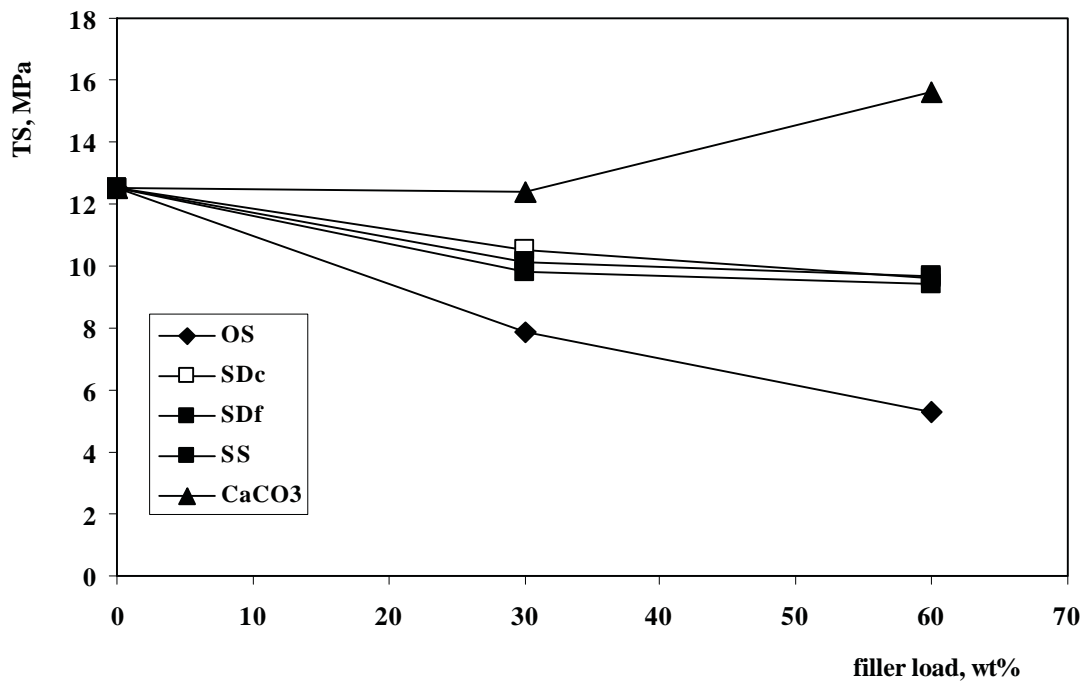

Fig. 11. Tensile strength as a function of the filler content for injection molded samples

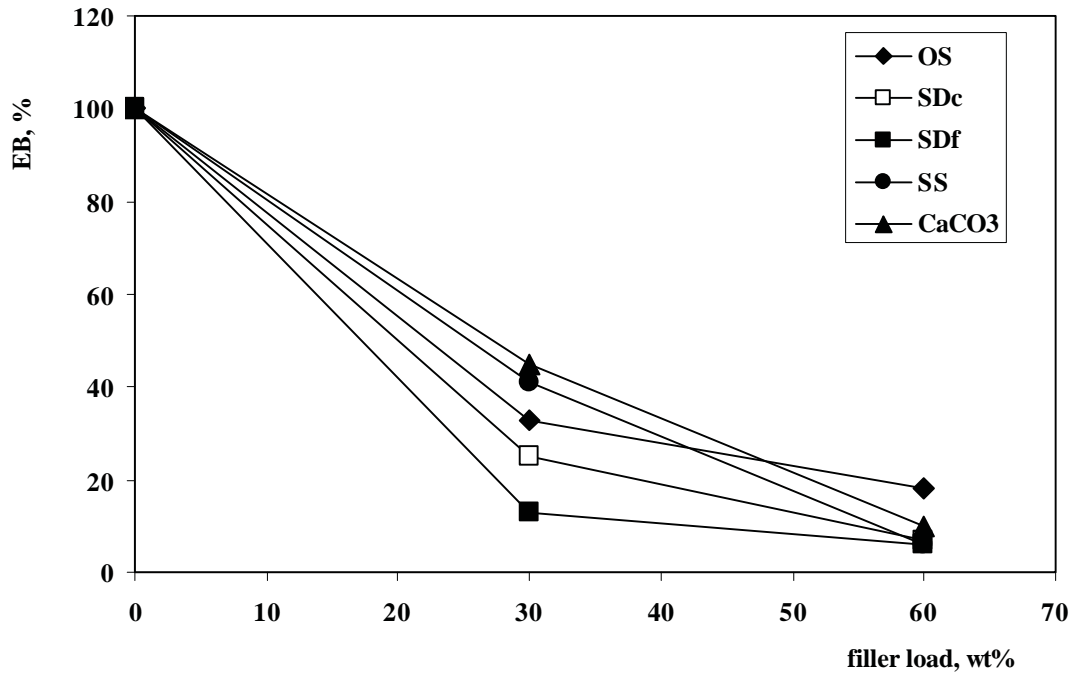

Fig. 12. Elongation at break as a function of the filler content for injection molded samples

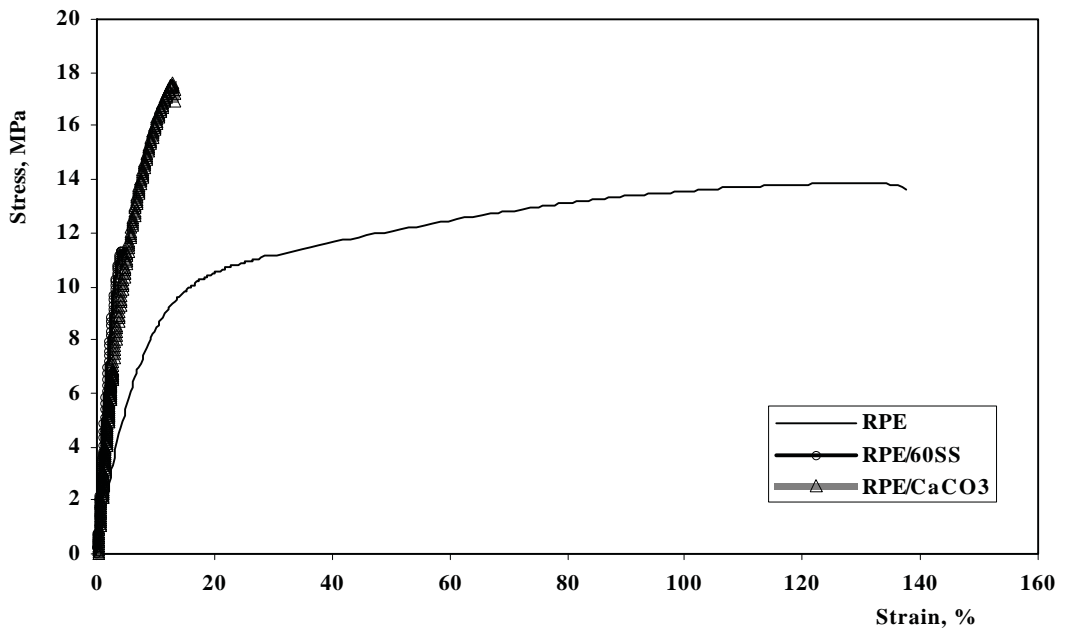

Fig. 13. Stress-strain curves for some materials

The best performance among all the fillers is shown by the sawdust and the finer granulometry does not seem to impart better properties with respect to the material filled with the same filler having larger size of the particles. In particular, with 60% of this filler the modulus is twofold the initial value, while the reduction of the breaking characteristics is the higher one.

The impact strength values are reported in Tab. 1. It is observed that impact strength worsens for all the samples, probably because of a poor adhesion with the non-polar matrix. Again the inorganic filler shows the best results while olive stones presents the best performance among the organic fillers and sago starch the lower ones.

Filler load, wt %	OS	SDc	SDf	SS	CaCO <sub>3</sub>
0	NB	NB	NB	NB	NB
30	NB	185	99	NB	NB
60	90	70	69	58	180

**Table 1.** Impact Strength [J/m] for the materials (NB=No Break)

The Heat Deflection Temperature (HDT) values are plotted in Fig. 14. It is easy to observe a significant increase in HDT with increasing the filler content (even though the enhancement obtained passing from 30% to 60% weight percent is less than one could expect).

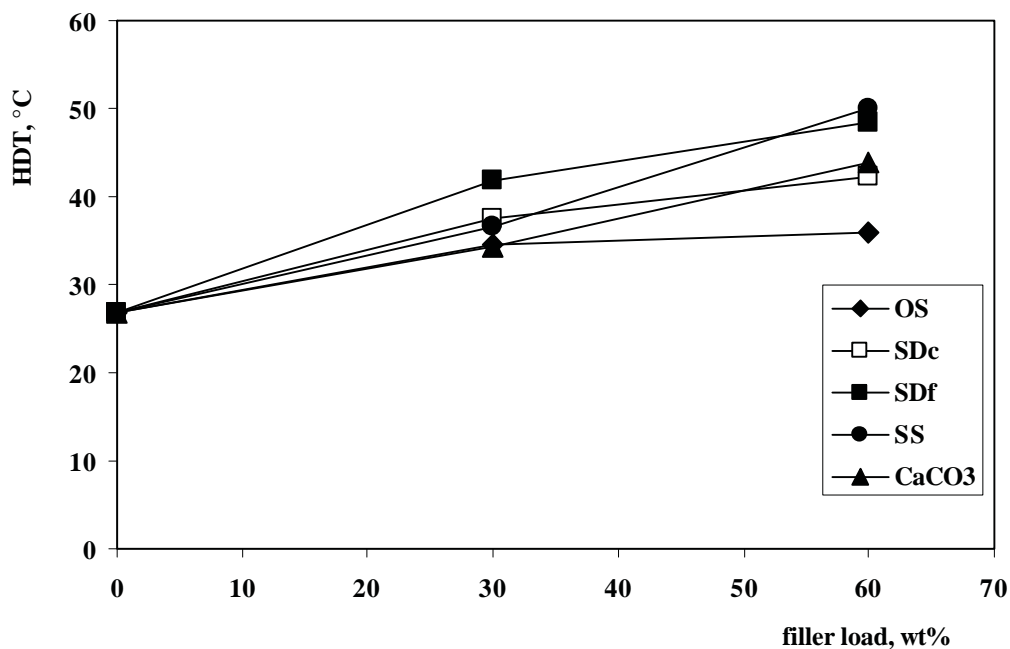

**Fig. 14.** HDT as a function of the filler content for injection molded samples

The best results are achieved with sago and with the finer sawdust. The HDT value is mainly dependent on the initial value of the elastic modulus, being the same matrix for all the samples. The HDT values obtained are in line with the values of the elastic modulus above reported.

## **Conclusions**

The addition of organic fillers to the post-consumer plastic matrices causes an enhancement of elastic modulus (and therefore of stiffness) and of the thermomechanical resistance, while a reduction of tensile strength and elongation at break is observed.

These effects were more marked with increasing filler content. Although in some cases the inorganic fillers give rise to a best enhancement of the overall performances of the plastic matrix, organic fillers may be considered as valid substitutes. In particular, very cheap fillers such as sawdust and olive stones filled materials show appreciable properties.

All the filled systems show a higher viscosity than the virgin matrix, thus being more difficult to process; this effect increases with increasing filler content.

Kenaf, sago and sawdust are therefore interesting alternatives for inorganic fillers to produce materials that are both low-cost and more environment-friendly than pure polymers, especially in the field of the recycled polymers.

It is, however, clear that to achieve significant enhancements in terms of mechanical resistance (especially for impact strength) it would be necessary to develop specific and cheap compatibilizers in order to overcome the difficulties related to filler dispersion in the matrix and interface adhesion between filler and matrix.

## **Acknowledgements**

Thanks are due to Prof. Carlos Vaca-Garcia, Institut National Polytechnique de Toulouse, Laboratoire de Chimie Agro-Industrielle UMR 1010 INRA/INP-ENSIACET (France), for supplying olive stones.

This work was supported by University of Palermo RS ex60%.



## References

- 1) Gachter-Muller, *Plastics Additives*, 3rd ed., Hanser Publishers (1990)
- 2) H.D. Rozman, C.Y. Lai, H. Ismail, Z.A. Mohd Ishak, *Polym. Int.*, 49, 1273 (2000)
- 3) K. Joseph, S. Thomas, C. Pavithran, *Polymer*, Vol. 37, No. 23, p. 5139 (1996)
- 4) P.V. Joseph, K. Joseph, S. Thomas, *Composites Science and Technology*, 59, 1625 (1999)
- 5) G. Canchè-Escamilla, J. Rodriguez-Laviada, J.I. Cauich-Cupul, E. Mendizabal, J.E. Puig, P.J. Herrera-Franco, *Composites: Part A*, 33, 539 (2002)
- 6) K.C.M. Nair, R.P. Kumar, S. Thomas, S.C. Schit, K. Ramamurthy, *Composites: Part A*, 31, 1231 (2000)
- 7) P.W. Balasuriya, L. Ye, Y.W. Mai, J. Wu, *J. Appl. Polym. Sci.*, 83, 2505- (2002).
- 8) R.B. Raj, V.B. Kokta, D. Maldas, C. Daneault, *J. Appl. Polym. Sci.*, 31, 1358 (1991).
- 9) J.L. Willett, *J. Appl. Polym. Sci.*, 54, 1685 (1994).
- 10) R.P. Wool, D. Raghavan, G.C. Wagner, S. Billieux, *J. Appl. Polym. Sci.*, 77, 1643 (2000).
- 11) N. Sharma, L.P. Chang, Y.L. Chu, H. Ismail, Z.A. Mohd Ishak, *Polym. Degrad. Stab.*, 71, 381 (2001).
- 12) I. D. Danjaji, R. Nawang, U.S. Ishiaku, H. Ismail, Z. A. Mohd. Ishak, *J. Appl. Polym. Sci.*, 79, 29 (2001).
- 13) H.L. Chen, R.S. Porter, *J. Appl. Polym. Sci.*, 54, 1781 (1994).
- 14) A. Magurno, *Die Angewandte Makromolekulare Chemie* **272** (1999) 99-107 (N. 4751).
- 15) N. Tzankova Dintcheva, Ph.D. Dissertation (2000).
- 16) A.N. Netravali and S. Chabba, *Materials Today*, Vol.6, Iss. 4, April 2003, pp.22-26.
- 17) R.T. Woodhams, G. Thomas, D.K. Rodgers, *Polym. Eng. Sci.*, **24**, 1166 (1984).
- 18) C. Klason, J. Kubat, H.E. Stromwall, *Int. J. Polym. Mater.*, **10**, 159 (1984).
- 19) H. Dolveg, C. Klason, H.E. Stromwall, *Int. J. Polym. Sci.*, **11**, 9, (1985).
- 20) P. Bataille, L. Ricard, S. Sapiéha, *Polym. Compos.*, **10**, 2, (1989)
- 21) S.E. Selke, J. Childress, “ in “*Emerging technologies in plastic recycling*”, L.D. Andrews and P.M. Subramanian eds., ACS Symposium Series **513**, Washington (1992).
- 22) R.J. Simpson, S.E. Selke, in “*Emerging technologies in plastic recycling*”, L.D. Andrews and P.M. Subramanian eds., ACS Symposium Series **513**, Washington (1992).
- 23) K. Oksman, *Wood Sci. Technol.*, **30**, 197 (1996).
- 24) K.L. Yam, B.K. Gogoi, C.C. Lai, S.E. Selke, *Polym. Eng. Sci.*, 692, **30** (1990).
- 25) R.D. Park, J.J. Balatinez, *Polym. Compos.*, **19**, 377 (1997).
- 26) B. Liao, Y.H. Huang, G.M. Cong, *J. Appl. Sci.*, **66**, 1561 (1997).
- 27) T.Q. Li, C.N. Ng, R.H.Y. Li, *J. Appl. Polym. Sci.*, **81**, 6, 1420 (2001).
- 28) K. Oksman, C. Clemmons, *J. Appl. Sci.*, **67**, 1503 (1998).
- 29) D.R. Carroll, R.B. Stone, A.M. Sirignano, R.M. Saindon, S.C. Gose, M.A. Friedman, *Resources, Conservation and Recycling*, **31**, 241-251 (2001).
- 30) N. Tzankova Dintcheva, F.P. La Mantia, D. Acierno, L. Di Maio, G. Camino, F. Trotta, M.P. Luda, M. Paci, *Polym. Degrad. Stab.*, 72, 141-146 (2001).
- 31) N. Tzankova Dintcheva, F.P. La Mantia, *Polym. Adv. Technol.*, **10**, 607-614 (1999).
- 32) C. Vaca-Gracia, private communication.

# Mechanical recycling of polymer-clay nanocomposites prepared by melt compounding

D. Acierno<sup>1</sup>, P. Scarfato<sup>2</sup>, L. Incarnato<sup>2</sup>, L. Di Maio<sup>2</sup>

<sup>1</sup>Department of Materials and Production Engineering, University of Naples “Federico II”, P.le Tecchio 80, 80125 Napoli, Italy

<sup>2</sup>Department of Chemical and Food Engineering, University of Salerno, Via Ponte don Melillo, 84084 Fisciano (SA), Italy

## Introduction

Over last decade, melt compounded nanocomposite systems based upon thermoplastic polymers and layered silicate have achieving a growing market spread. In fact, loading the polymer with small amount of clay (ca. 5 wt%) a significant performance improvement of the material can be obtained with only a small increase in cost [1-3]. Moreover, the production technique by melt compounding has a real industrial potential for its versatility and compatibility with the conventional polymer manufacturing processes. Due to the technological relevance of nanocomposites, testified also by the numerous patents issued over the last few years, the development of recycling processes for these systems is of great interest.

Amongst different recycling technologies, for nanocomposite systems based on thermoplastic polymers the thermo-mechanical recycling is the most favourable for economic, technological and environmental reasons. Nevertheless, due to the presence of a second material as the reinforcing phase, recycling is comparatively more difficult in these materials than in monolithic ones because during reprocessing, besides the matrix degradation, morphological modifications and interfacial interaction changes have to be controlled, too [4-5]. Although nanocomposites are expected maintains their excellent properties even when recycled, due to the ultrafine size of the silicate sheets, at the present time only few data are reported in literature on recycling of these systems [1]. Experimental works represent, therefore, an indispensable contribution to investigate the relationships between recycling process, nanostructure and functional properties of the manufactured articles.

In this field, we are conducting a preliminary investigation on the effect of repeated processing operations on the structure and the properties of melt compounded nanocomposites based upon nylon 6 matrix. At this regard, polymer/silicate nanocomposite systems, containing different loadings (3 wt% and 6 wt%) of commercial organomodified montmorillonite (traded as Cloisite 30B by SCP), were prepared by melt compounding using

a twin-screw extruder and then submitted to repeated recycling processes with and without the addition of stabilizers. All the produced systems were analysed performing x-ray diffraction measurements in order to verify that the silicate nanometric dispersion in the matrix was preserved after recycling. Moreover, thermal and mechanical tests were carried out on the samples, to compare their performances.

## **Experimental**

A commercial nylon 6 (PA6 F34L, IV=3.4 dl/g, supplied by Caffaro S.p.A. - Italy) was used for this study. The layered silicate used (traded as Cloisite 30B by Southern Clay Products) was a natural montmorillonite organically modified by N,methyl-N,tallow-N,N',2-hydroxyethyl-ammoniumchloride (90 meq/100g clay), having interlayer basal spacing  $d_{001}=18.5 \text{ \AA}$ .

Mechanical polymer-silicate blends at two different percentages of Cloisite 30B (3 wt% and 6 wt%) were prepared and dried in a vacuum oven at 80°C for 16 h to avoid moisture induced degradation reactions. The melt compounding of the blends was performed using a twin-screw extruder having counter rotating screws with L/D=20 and L=500mm. The extrusion was carried out with a temperature profile of 260°C-265°C-255°C-250°C and a screw speed of 60 rpm. After production all samples (neat nylon 6 and nanocomposite hybrids) were ground with a blade mill (Retsch Muhle, Haan, Germany), dried under vacuum at 80°C for 16h and re-extruded. The mechanical recycling was performed by means of a single screw extruder (Brabender Do-corder E330) using a temperature profile of 260-260-255°C and a screw speed of 50 r.p.m. This sequence was repeated two times, with and without the addition of stabilizer agents (0.5 wt% Irgafos 168 + 0.5 wt% Irganox 1010, supplied by CIBA). As listed in table 1, the unstabilized and stabilized samples, processed up to three times with different clay loadings, will be called in the following as NY6-*i*-R<sub>*j*</sub> and NY6-*i*-R<sub>*j*</sub>.S (where *i* = 0, 3 or 6 wt% is the clay percentage and *j* = 0, 1 or 2 is the number of recycling performed), respectively.

X-ray diffraction spectra were recorded by a flat camera with a sample-to-film distance of 140 mm (Ni-filtered Cu-K $\alpha$  radiation). The Fujifilm MS 2025 imaging plate and a Fuji Bio-imaging Analyzer System, mod. BAS-1800, were used for digitizing the diffraction patterns.

Mechanical tensile properties in the extrusion direction were determined with an Instron dynamometer (mod. 4301) on rectangular samples (11.7 mm x 110 mm), using a cross-head speed of 5 cm/min. All specimens were preconditioned in water-impermeable container for 24h before mechanical measurements were performed, according the ASTM D-638.

<i>Sample name (unstabilized)</i>	<i>Sample name (stabilized)</i>	<i>Clay loading (wt%)</i>	<i>No. of recycling</i>
NY6	NY6.S	0	0
NY6-R1	NY6-R1.S		1
NY6-R2	NY6-R2.S		2
NY6-3	NY6-3.S	3	0
NY6-3-R1	NY6-3-R1.S		1
NY6-3-R2	NY6-3-R2.S		2
NY6-6	NY6-6.S	6	0
NY6-6-R1	NY6-6-R1.S		1
NY6-6-R2	NY6-6-R2.S		2

Table 1. Sample nomenclature.

## Results and discussion

In order to verify that in the melt compounded nylon 6-based hybrids, produced with our experimental conditions, the organo-modified silicate used is dispersed on a nanometric scale, preliminary X-ray measurements were performed both on neat matrix and hybrids with different clay percentages.

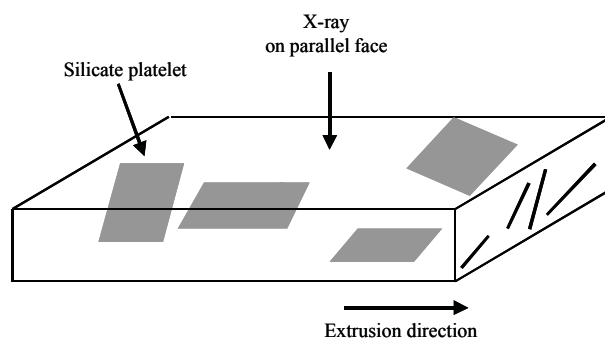

Figure 1. Schematic representation of incident X-ray path on the samples.

X-ray experiments were carried out on nanocomposite samples oriented such that the incident beam was reflected off whether the parallel face to the extrusion direction, as shown in figure 1. The intensity profiles *vs.*  $2\theta$  of the NY6-6 hybrid and the pristine Cloisite 30B are also compared in figure 2, to better evidence the enlargement of layers separation occurring in the nanocomposite system.

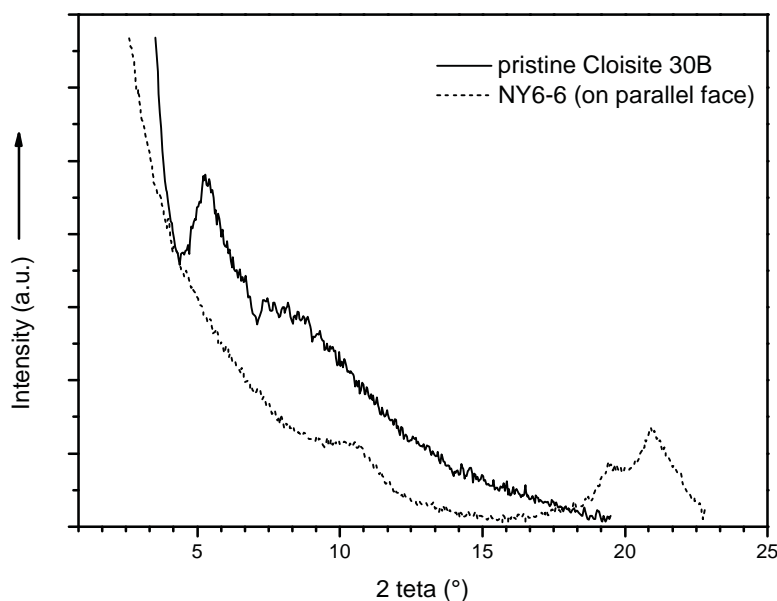

Figure 2. Comparison between the x-ray intensity profiles vs.  $2\theta$  of the NY6-6 hybrid and the pristine Cloisite 30B.

The scattering curve of the pristine organoclay exhibits a broad intense peak corresponding to a basal spacing  $d_{001}=18.5\text{\AA}$ . This reflection is no more present in the pattern of NY6-6 sample (figure 3a), where only a low broad halo can be detected at decreasing angles, thus pointing out that the silicate interstratic gap is increased in the nanocomposites. These results suggest that the hybrid systems have regions of intercalated clay and regions of exfoliated clay layers. Similar XRD patterns were also obtained for recycled nanocomposites. As example, figure 3b reports the diffractogram corresponding to NY6-6-R2 sample for comparison. All these X-ray data show that a nano-scale dispersion of the Cloisite 30B in NY6 matrix was obtained in our experimental conditions and preserved after recycling.

Mechanical measurements were carried out on neat nylon 6 and nanocomposite samples with different silicate percentages, extruded up to three times with and without the addition of stabilizer agents. Figures 4-6 show the effect of recycling on the tensile modulus, the stress at break and the elongation at break, respectively, for all produced samples. The tensile tests have shown that, increasing the clay amount in both virgin and recycled nanocomposites, tensile modulus and stress at break increase, whereas elongation at break decreases, compared with the neat matrix. For samples at fixed clay loadings, a further increase in the tensile modulus and stress at break can be observed after recycling. The elongation at break shows an

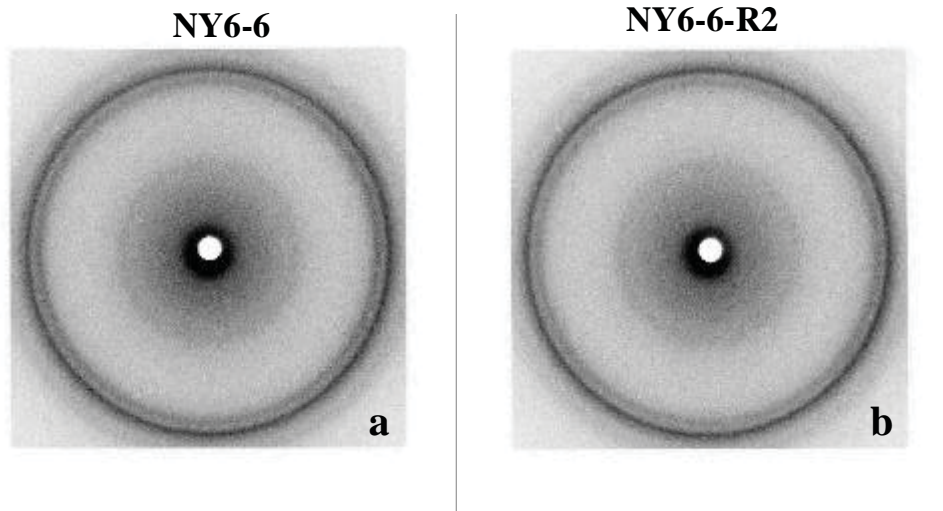

Figure 3. X-ray diffractograms for the nanocomposite samples with 6 wt% of clay: virgin (a) and recycled two times (b).

opposite trend. One cause of these results may be a better dispersion of silicate platelets in the nylon 6 matrix achieved after reprocessing. However, similar trend in the mechanical response was already reported in literature for neat polyamides submitted to several recycling operations and was related to the different structural organization (crystallinity degree, crystal size and shape, etc.) developed in the recycled samples [5].

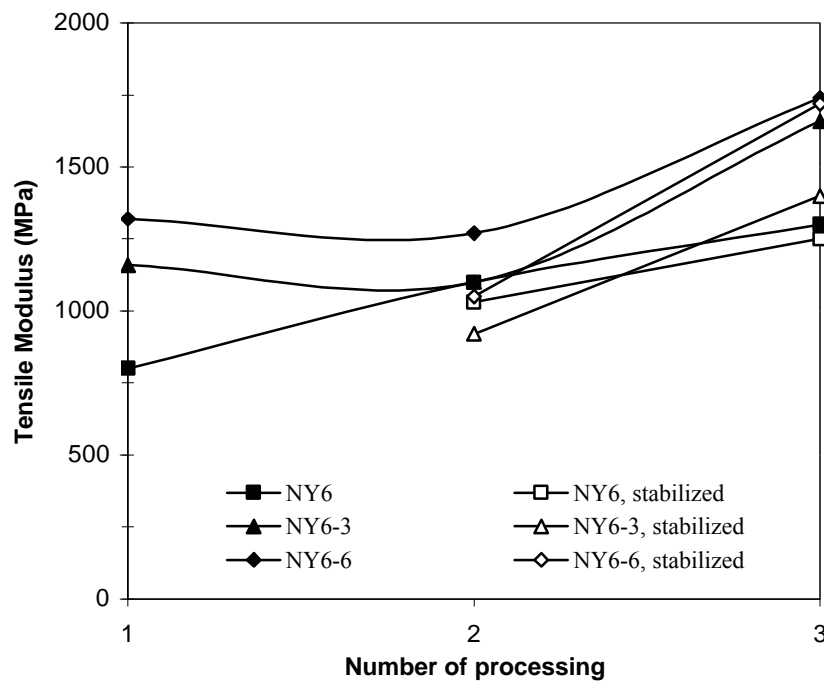

Figure 4. Effect of recycling on the tensile modulus of nanocomposite samples with different clay loadings.

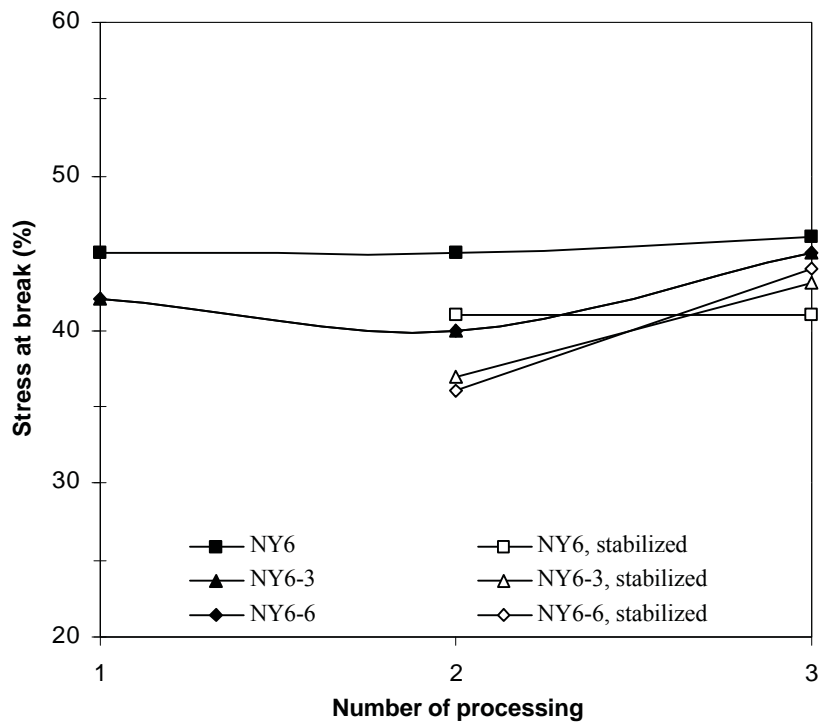

Figure 5. Effect of recycling on the stress at break of nanocomposite samples with different clay loadings.

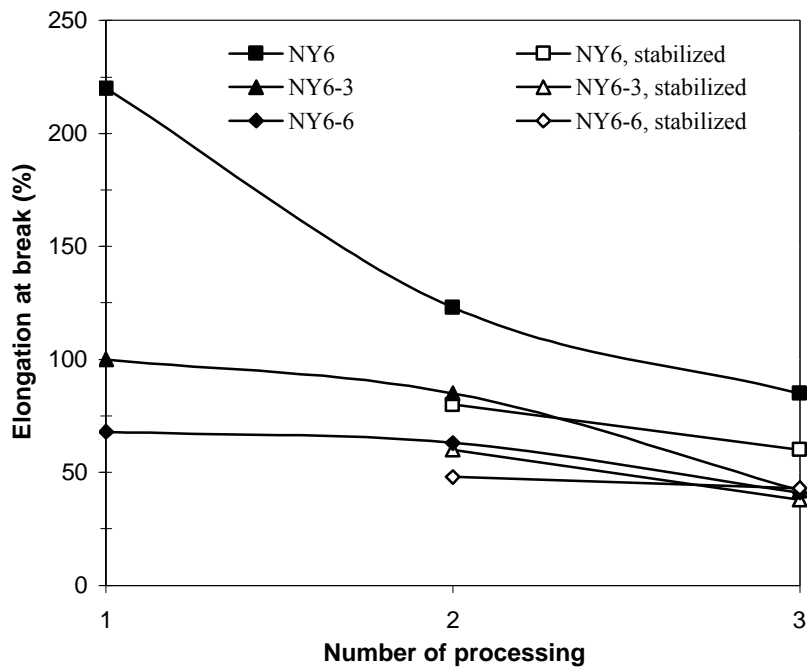

Figure 6. Effect of recycling on the elongation at break of nanocomposite samples with different clay loadings.

## Conclusions

Nanocomposites based on nylon 6 and Cloisite 30B were prepared by melt compounding at different silicate loading and submitted to repeated recycling in order to evaluate the effect of reprocessing on both the nano-scale dispersion of the silicate and the mechanical response of the nanocomposites. X-ray analysis revealed that all produced samples exhibit an intercalated/exfoliated morphology and that the nano-scale dispersion of the silicate platelets wasn't lost after recycling. Concerning the mechanical performance, as expected all virgin nanocomposites show a more rigid behavior respect to the neat matrix. The changes in the tensile parameters are marked even at lowest clay percentages used and were further increased after recycling. These result may be related both to a better dispersion of silicate platelets in the nylon 6 matrix after reprocessing and to a different structural organization developed in the recycled samples.

## Acknowledgements

The authors wish to thank Mr. Salvatore Montesano from University of Salerno (Italy), for recycling experiments.

## References

- [1] T.J. Pinnavaia and G.W. Beall (Eds.), 'Polymer-Layered Silicate Nanocomposites', 2001, N.Y., John Wiley & Sons.
- [2] J. Garcés, D.J. Moll, J. Bicerano, R. Fibiger, D.G. McLeod: *Adv. Mater.*, 2000, **12**(23), 1835-1839.
- [3] M. Holmes, *Plastics Additives & Compounding*, 2000, **7/8**, 34-36.
- [4] J. Scheirs, 'Plastic Recycling. Science, technology and applications' John Wiley & Sons, New York, 1998.
- [5] F.P. La Mantia (Ed.), 'Handbook of Plastic Recycling', Publisher: Rapra Technology Ltd., Shrewsbury, UK, 2002.



# **Interaction between wood and PVC during pyrolysis chlorine capture: extrapolation from lab to pilot scale.**

C.Gisèle JUNG, Dr.Sc.

Université Libre de Bruxelles, 50, av.F.D.Roosevelt, CP 165/61, B1050 Brussels  
[cgjung@ulb.ac.be](mailto:cgjung@ulb.ac.be) tel +32 2 650 3051 fax +32 2 650 3575

## **Introduction**

Recycling materials is today a strategic priority with the aims of sustainable development. Economy of natural resources and of energy, decrease in waste disposal and in carbon dioxide emissions is the main challenge of the future. For single plastics products, such as packaging, household products, construction materials are easy to sort and to send to reprocessing units. But, a lot of polymeric materials are parts of large equipments and a dismantling procedure has to be achieved in order to separate metals and polymers with a good quality for the recycling process. There is an economical limit in the separation of the different kinds of polymers present in the refused equipments (electronic equipments, old cars, municipal waste, etc.). Any dismantling unit generate mixed plastics refuse, so that there is a need for processing these new waste streams.

A lot of waste streams contain wood, mixed plastics with PVC and metals. Incineration of this contaminated energetic waste could be difficult, but pyrolysis is an attractive alternative. During pyrolysis, all the metals will be recovered (and separated) in the char, but there are interactions of the chlorine evolved by the PVC during pyrolysis with lignin<sup>1</sup> and with the metals.

Reactions of the chlorine with lignin and cellulose are examined. But if metals or calcium carbonate are present in the waste, the chlorine is selectively captured by these products<sup>2</sup>.

This work deal with the dechlorination during pyrolysis of wood-PVC mixtures in order to produce dechlorinated substitution fuels<sup>3</sup>.

## **Experimental procedure**

Mixtures containing defined proportions of wood and PVC contaminated with lead oxide are made in order to simulate waste fractions. They are pyrolysed at laboratory scale with calcium based additives. The behaviour of pollutants (i.e. Pb and Cl) is studied to use the pyrolysis char safely as substitution fuel.

### **1. Laboratory scale .**

All pyrolysis experiments were performed in a fixed-bed reactor<sup>7</sup> with a total charge of about 150g. The starting mixtures were heated at atmospheric pressure up to 700°C at a heating rate of 10°C/min to 40°C/min. The hot pyrolytic gases are carried out of the furnace by a nitrogen flow (0.6 dm<sup>3</sup>/min). Condensable matter is recovered in cold traps and weighted. The uncondensed gases are washed (in water for HCl trapping) and collected for analysis. The mass of solid, condensable gases and hydrochloric acid are measured. The quantity of uncondensable gases is determined by difference.

Few experiments have been performed in a batch rotary kiln with a charge of about 150g in the temperature range from 350 up to 550°C, rotary speed between 0,5 to 4 rpm and bed height from 3 to 7 cm.

### **2. Pilot scale.**

CUTEK pilot plant in Clausthal consists in a 20 to 30 kg/h rotary kiln of a length over all of 5.8m and a diameter of 300mm (40kW heated length of 3.6m length),

At the hot gas output of the rotary kiln, a discontinuous gas sampling of the pyrolytic gas device is equipped with a so called-finger type cooler and behind it a spiral cooler.

Another discontinuous gas sampling of the purified uncondensable pyrolytic gas is placed after washing column.

### Waste pyrolysis

The mixed waste is characterised by its dry matter (OM+MM), ash content (MM) and its calorific value.

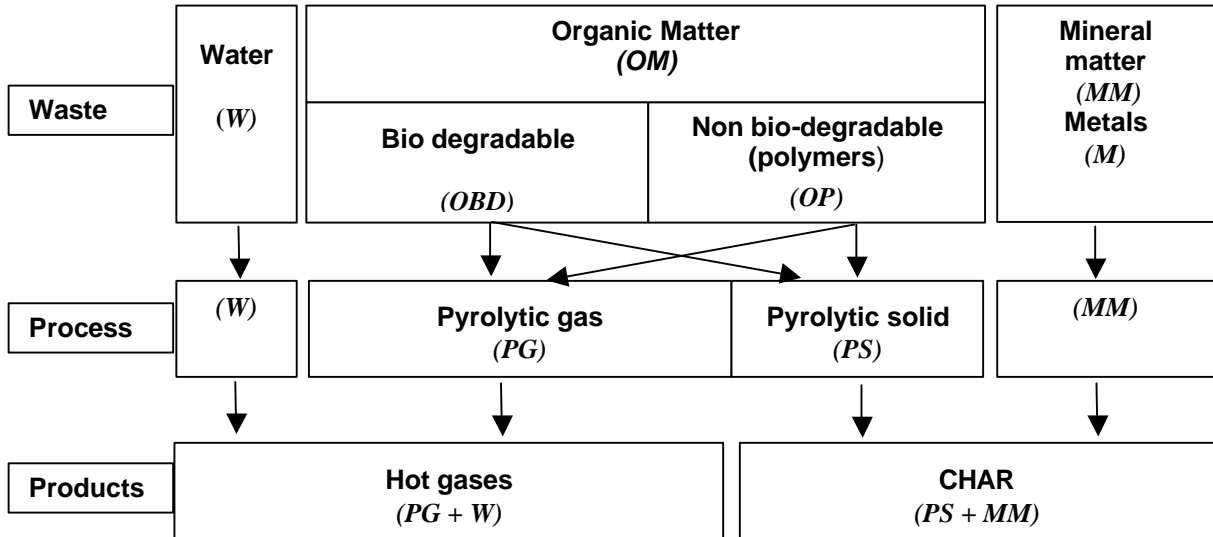

During pyrolysis, the carbonization of the organic fraction (*OM* being divided in *OBD* + *OP*) gives a solid carbonaceous phase (*PS*) and gas phase (*PG*) (condensables and non-condensables). The pyrolytic products are hot pyrolytic gases (*PG* + *W*) and a solid char (*PS* + *MM*).

Chlorine contained in waste has a complex behaviour during pyrolysis. It evolves mostly as HCl under 350°C in the preliminary stage of the PVC thermal degradation<sup>4</sup>. Then competitive reactions take place and the chlorine can follow different paths, depending on the chlorine environment in the charge during pyrolysis<sup>5</sup> and are presented in figure 1.

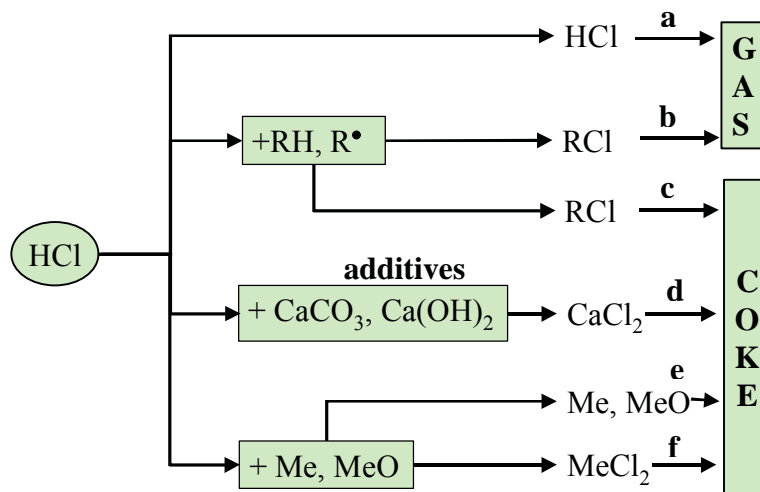

Figure 1

Hydrochloric acid is recovered partly with the pyrolytic gases (path a). Chlorine could react with hydrocarbons in the gas phase and with radicals produced during pyrolysis to form condensable or non-condensable organic chlorinated compounds in the hot gases (path b).

We recently demonstrated that cellulose and lignin, usually present in the municipal solid waste, interact differently with PVC during pyrolysis<sup>1</sup> and modify the chlorine distribution between the gaseous and solid phases. With a high lignin content in the waste, chlorine is entrapped in the char (path c), but with a high cellulose content, chlorine concentrates in the hot pyrolytic gases (path b).

It is important to guide the chlorine either in the gas or in the char outputs by selected additions, in order to fit with the requirements of the fuels end users. When the char during pyrolysis entraps the chlorine under leachable form, it can be eliminated before further use.

The effect on chlorine trapping by mixing alkaline reactants with waste during pyrolysis has been studied previous<sup>2,6</sup>. The presence of lime or limestone during pyrolysis entraps the hydrochloric acid evolved by the PVC before reactions with the organic material present in the gas phase so that leachable calcium chloride is captured in the char (path d).

Laboratory results have been validated at pilot scale at the CUTEC Institute through a COPES Programme.

The aim of this work is to determine the influence of basic additions on the behaviour of the chlorine during pyrolysis of PVC-wood mixtures at lab and pilot scales (efficiency of path d).

## Results and discussion.

### 1. Laboratory scale experiments

Pyrolysis of wood and quartz contaminated by PVC has been pyrolysed with and without calcium carbonate addition. Quartz has been added in order to simulate the inert part of the waste. Leachable chlorine and lead from the char have been determined.

*In the fixed bed*, the results are presented in Table 1.

**Table1: Influence of calcium carbonate additions in the fixed bed reactor**

Run N <sup>r</sup>	INPUT*					Pyrolysis CHAR
	T °C	Inert (SiO <sub>2</sub> ) (g)	Wood (g)	PVC (g)	CaCO <sub>3</sub> (g)	Cl leachable %
L-11	500	40	--	2	--	7.3
L-10	500	40	10	0.1	--	4.1
L-9	500	40	10	0.1	4.7	45.3

\*Laboratory pyrolysis experiments performed with ~ 150g charge input at ULB

It has been shown that in the absence of wood, the chlorine is released in the form of HCl that is eliminated with the pyrolytic gases. If calcium carbonate is added during pyrolysis, about half of the chlorine input is entrapped in the char as soluble calcium chloride (L-9).

*In a batch rotary kiln*, using the same proportions wood/PVC/CaCO<sub>3</sub> at 530 to 550°C (4 rpm) but without inert support (SiO<sub>2</sub>), experiments show less chlorine leachability, only 15%. Furthermore, the modification of several parameters separately such as

- decreasing the bed height (5,5 to 3 cm) or the wood proportion (factor 2)
- increasing the heating rate (10 to 40°C/min)), the rotating speed (0,5 to 4 rpm) or final temperature (370 to 550°C)

shows a small effect on the chlorine leachability with an increase from 15 to 26%.

As a consequence, without inert support, results in fixed bed laboratory reactor are better extrapolated at pilot scale than those in the batch rotary kiln.

Finally, more experiments have been performed in the fixed bed reactor and an increase of the pyrolysis temperature (from 500°C to 700°C) on the leachable fractions is summarised in Table 2.

**Table 2: Influence of pyrolysis temperature in fixed bed (mass calculated for 10g of wood)**

Run N <sup>r</sup>	INPUT*					Pyrolysis CHAR
	T °C	Inert (SiO <sub>2</sub> ) (g)	Wood (g)	PVC (g)	CaCO <sub>3</sub> (g)	Cl leachable %
L-10	500	40	10	0.1	--	4.1
L-8	700	40	10	0.1	--	3.6
L-9	500	40	10	0.1	4.7	45.3
L-6	700	40	10	0.1	4.7	79.5

\*Laboratory pyrolysis experiments performed with ~ 150g total charge input at ULB

In the presence of calcium carbonate, the increase of temperature increases the calcium chloride formation (L-9 and L-6).

## 2. Pilot scale experiments

In the continuous rotary kiln, a charge of wood contaminated by PVC has been pyrolysed with and without calcium carbonate or sludge addition in order to verify the scaling up effect on the laboratory scale results.

**Table 3: Influence of CaCO<sub>3</sub> or sludge [Ca(OH)<sub>2</sub>] additions in a rotary kiln**

Run N <sup>r</sup>	T °C	INPUT*				Pyrolysis CHAR
		Wood (kg)	PVC (kg)	CaCO <sub>3</sub> (kg)	Sludge (kg)	Cl leachable %
P-2	500	10	1.1	--	--	2
P-8	500	10	--	--	--	na
P-9	500	10	1	--	--	7
P-3	500	10	1	4.7	--	59
P-10	500	10	1	4.7	--	43
P-15	500	10	1	4.7	--	36
P-4	500	10	1	--	11	60
P-11	500	10	1	--	11	57
P-12	700	10	1	--	11	85
P-13	700	10	1	--	11	73

\*Continuous pilot scale pyrolysis experiments performed with ~22kg/h total charge throughput (CUTEC)

If calcium carbonate (P-3, P-10 and P-15) or sludge (P-4 and P-11) is added to this charge, there is an increase of the leachable chlorine (between 40 and 60%).

Higher temperature pyrolysis experiments show an increase of the leachable chlorine from the char up to about 80% (P-12 and P-13).

### *Interpretation of results*

The interpretations of the results are based on the chlorine distribution illustrated in figure 1. When calcium carbonate or sludge is present during pyrolysis, the chlorine is captured in the char as leachable calcium chloride.

This work shows that the results obtained at laboratory scale in a fixed bed gives results that are representative of those obtained at pilot scale.

Using CaCO<sub>3</sub> or sludge as basic additives, better chlorine capture in the pyrolysis char, as leachable calcium chloride, can be realized at pilot scale than at laboratory scale .

### **Conclusions.**

Depending on the waste nature (municipal or industrial waste, automobile shredder refuse, contaminated soil,...), chlorine could be entrapped in the char in a non-leachable form by wood . By selected additions into the waste input, such as calcium carbonate or calcium hydroxide, the majority of the chlorine could be eliminated before the energetic valorisation of the char. Indeed, when chlorine is stabilised as calcium or sodium chloride, washing the char before the energy valorisation can easily leach it out.

These basic additions could also stabilise the heavy metals as oxides in the char ashes instead as volatile chlorides. Presence of chlorine in the absence of these basic additions during pyrolysis could produce unleaded char.

These results could also be applied at the first stage on incinerator grid systems.

### **Acknowledgements**

The authors thank Professor M. Beckmann (Bauhaus-Universität Weimar) and Dipl.Ing. J. Gerhman (CUTEC Institute) for collaboration in the pilot scale experiments.

---

<sup>1</sup> Ph.Laurent, C.Kestemont C.Braekman-Danheux, A.Fontana, Erdöl, Erdgas Kohle, 116, 2000, 89-92.

<sup>2</sup> A.Fontana, Ph.Laurent, C.G.Jung, J.Gehrmann, M.Beckmann, Erdöl, Erdgas Kohle, 117, 2001, 362-366.

<sup>3</sup> A.Fontana, Environmental Protection Bulletin, 055, 1998, 3-5

<sup>4</sup> H.Bockhorn, A.Hornung, U.Hornung, S.Teepe, J.Weichmann, Combust.Sci.and Tech., 1996, 116-117; 129-151.

<sup>5</sup> A.Fontana, Environmental Protection Bulletin, IChem<sup>E</sup>, 055, 1998, 3-5

<sup>6</sup> J.Gehrmann, M.Beckmann, C.G.Jung, A.Fontana, Incineration 2001, Ichem<sup>E</sup> meeting, Brussels, July 2001.

# Detailed kinetic modeling of thermal degradation of plastics

Tiziano Faravelli, Alessandro Marongiu and Eliseo Ranzi  
CMIC – Dipartimento di Chimica, Materiali e Ingegneria Chimica  
Politecnico di Milano  
P.za L. da Vinci 32, Milano (Italy)

## Introduction

The growing amount of plastic residue in the municipal solid waste claims for accurate investigations and developments of new technologies able to face the resulting environmental impact. Until recently, the polymeric materials are mostly incinerated together with other household waste. This option is not the way to increase their value and is not considered fully acceptable by current policies. Pyrolysis and gasification processes have been recognized as promising routes for the upgrading of solid wastes to more valuable and energy-dense materials, such as fuel gas and/or fuel oil, or to high value feedstocks useful to the chemical industry.

Thermal efficiency of the system, operational problems and the control of pollutants emissions still require basic research technologies for optimal large scale. Over the last decade, several reports on pyrolysis and gasification of plastics are present in the literature [1-6].

Generally speaking, kinetic models with lumped-parameters are proposed for polymer degradation, describing the pyrolysis process with simplified reaction pathways. Each individual reaction step considered can be representative of a complex reaction network.

In most studies a standard power law model has been used to describe the pyrolysis weight loss:

$$\frac{d\alpha}{dt} = k_0 \cdot e^{\left(\frac{-E_a}{RT}\right)} \cdot (1 - \alpha)^n$$

Where  $\alpha$  is the conversion ratio and  $n$  the order of reaction. The standard Arrhenius parameters are reported with their usual meaning:  $k_0$  is the pre exponential factor and  $E_a$  the activation energy. The kinetic parameters and the order of reaction are evaluated using standard thermogravimetric analyzers (TGA). The experiments refer both to isothermal and non-isothermal (or dynamic) conditions.

Particular attention has been devoted to those polymers, which are the most abundant in the domestic refuses. Polyethylene (PE) both low (LDPE) and high (HDPE) density, polypropylene (PP), polystyrene (PS) and polyvinylchloride (PVC) encompass about 80% by weight of the total plastic fraction.

Table 1 presents a summary of kinetic parameters from the literature, carried out in different operating conditions. It is possible to observe that the reaction orders are different and this is especially connected to the degree of conversion reached in the experiment. Consequently, the resulting rate parameters ( $k_0$  and  $E_a$ ) significantly differ. The rate constants span over a couple of orders of magnitude even considering only experiments where the heat and mass transfer limitation are negligible. These differences are the result of various aspects. The initial plastic material with the presence of additives or different numbers of weak links; the polymer molecular weight and the measurement uncertainties can play an important role. However, the use of a simple single step reaction, especially over wide ranges of operative conditions, is the main reason of these discrepancies [7].

This lack of validity is well known since many years and several efforts have been done to overcome this difficulty. Oakes and Richard discussed a two conversion rate models, one for

the low and another for the high conversion of PE pyrolysis [8]. The presence of weak bonds has been assumed to explain the initial higher reactivity of the polymer.

Polyethylene				Polypropylene				Polystyrene			
$E_a$ (kJ mol <sup>-1</sup> )	n	$k_0$ (min <sup>-1</sup> )	Ref.	$E_a$ (kJ mol <sup>-1</sup> )	n	$k_0$ (min <sup>-1</sup> )	Ref.	$E_a$ (kJ mol <sup>-1</sup> )	n	$k_0$ (min <sup>-1</sup> )	Ref.
251- 293			[8]	242.44			[9]	187	0		[10]
192	0	$1.0 \times 10^{13.6}$	[11]	246.62			[12]	209			[13]
220	0	$1.0 \times 10^{15.8}$	[11]	284			[14]	243	0 - 1		[15]
276	0	$1.0 \times 10^{19.8}$	[11]	209			[16]	205			[17, 18]
276	0	$1.0 \times 10^{19.8}$	[10]	257			[19]	192	0.0		[20]
285	1		[15]	224	0.78	$8.6 \times 10^{11}$	[21]	251	1.0		[20]
268			[22]	258 - 230			[19]	243			[23]
285-301	1		[24]	213			[19]	310	1.1	$8.3 \times 10^{19}$	[21]
280	1		[20]	83 - 128			[25]	83	0		[26]
259	0.81	$7.2 \times 10^{13}$	[21]	99			[25]	90	1		[26]
274			[27]	213	1	$3.3 \times 10^{13}$	[28]	323	1	$5.0 \times 10^{24}$	[29]
304	1	$1.3 \times 10^{21}$	[30]	234	1	$1.4 \times 10^{15}$	[28]	188	0	$1.0 \times 10^{13.1}$	[11]
290	1	$3.1 \times 10^{20}$	[30]	251	1	$4.0 \times 10^{18}$	[31]	134	0		[23]
220	1	$1.9 \times 10^{13}$	[7]	285			[32]	100 - 140	1		[33]
241	1	$1.0 \times 10^{15}$	[7]	173.9	1	$1.2 \times 10^{10}$	[34]	190 - 230	1		[33]
201	1	$9.8 \times 10^{11}$	[7]	171.8	1	$2.0 \times 10^{10}$	[34]	152	1	$1.8 \times 10^{11}$	[35]
320	1	$7.1 \times 10^{21}$	[30]	247	1	$1.0 \times 10^{14.4}$	[36]	244	1	$9.0 \times 10^{15}$	[37]
303	1	$5.8 \times 10^{21}$	[30]	243	1		[38]	189 - 440	1		[39]
330 - 247	0-1		[40]	244	1	$3.2 \times 10^{15}$	[7]	219 - 229	1	$1.0 \times 10^{14.5}$	[41]
163 - 230	0-1		[40]	188	1	$2.2 \times 10^{11}$	[7]	204	1	$3.3 \times 10^{13}$	[7]
225	1	$9.9 \times 10^{12}$	[42]	144			[43, 44]	92	1		[45]
281			[46]	183	0.90	$3.72 \times 10^{12}$	[47]	176	1	$3.6 \times 10^{13}$	[48]
275	1	$1.1 \times 10^{18}$	[49]	12.5	1.0	$4.80 \times 10^{-2}$	[50]	165	1	$6.1 \times 10^{12}$	[48]
233	0.74	$5.58 \times 10^{15}$	[47]	230	0.5	$1.20 \times 10^{16}$	[50]	177	0.75	$3.5 \times 10^{11}$	[51]
206	0.63	$7.20 \times 10^{13}$	[47]	125	0.40	$2.04 \times 10^8$	[52]	172	0.5	$3.00 \times 10^{12}$	[47]
159	1	$1.2 \times 10^9$	[49]					220	0.51	$3.00 \times 10^{12}$	[53]
250	0.65	$1.71 \times 10^{17}$	[52]					276	1.02	$3.67 \times 10^{19}$	[53]
120	1.40	$1.34 \times 10^9$	[52]					187	0.80	$8.58 \times 10^{13}$	[53]
220	0.60	$1.47 \times 10^{15}$	[52]					2.1	1.0	$1.20 \times 10^{-2}$	[50]
								272	0.5	$3.00 \times 10^{20}$	[50]
								120	1.60	$1.06 \times 10^8$	[52]
								185	0.76	$2.32 \times 10^{13}$	[52]
<b>Polyvinylchloride</b>											
126	1.5	$9 \times 10^{13}$	[47]	136.8	0.46	$1.65 \times 10^{12}$	[53]	243	1.55	$6.47 \times 10^{16}$	[54]
201	0	$9 \times 10^{13}$	[47]	146.5	1.54	$2.95 \times 10^{12}$	[53]	198	1.04	$3.57 \times 10^{18}$	[54]
209	1.5	$2.88 \times 10^{13}$	[47]	239.1	1.62	$4.70 \times 10^{16}$	[53]	143	1.15	$9.95 \times 10^{10}$	[54]
327	1.5	$3.36 \times 10^{13}$	[47]	200	0.98	$2.18 \times 10^{18}$	[54]	243	1.58	$5.77 \times 10^{16}$	[54]
143.5	0.54	$3.16 \times 10^{12}$	[3]	153	1.10	$1.26 \times 10^{11}$	[54]				
234.1	1.64	$2.23 \times 10^{16}$	[3]								

**Table 1. Experimental kinetic parameters reported in literature for the main staple plastics: polyethylene, polypropylene, polystyrene and polyvinylchloride.**

Simha et al. proposed a simplified depolymerization model which accounts for initiation, propagation and termination reactions [56]. Anthony and Howard assume for the coal pyrolysis an infinite number of first order parallel reactions, whose activation energies typically have a Gaussian distribution [57]. The preexponential factors, which are all the

same, can also be function of the activation energy. This modeling approach was also extended to PE pyrolysis [58, 59].

Anthony proposes for PVC thermal degradation a model, which involves 5 pseudospecies and 5 reactions, and which is able to describe the weight loss during the whole thermogravimetric experiments [60]. These approaches can only adequately describe the apparent kinetics in narrow ranges and do not allow to define reliable kinetic parameters applicable over wide ranges of operating conditions. A few step model is not able to cover a wide range of heating rates, temperatures and conversion levels with the same kinetic parameters. Therefore, experiments of dynamic and isothermal analysis reveal different decomposition rates [61]. Furthermore, the possible presence of mass and heat transfer limitations, which are generally neglected, spreads the range of variation of these kinetic constants. As a result of the aforementioned considerations, the interest of a mechanistic model capable of accounting for the differences in starting material and able to describe the reaction process over wider ranges of conditions is obvious. Moreover, mechanistic models allows the prediction of the detail of gas product distribution, which is a significant step in the possible upgrading of solid wastes.

In our knowledge, the most sophisticated attempt in this direction refers to the population balance-based models able to describe the molecular weight changes in the liquid phase during pyrolysis processes. Aris and Gavalas elaborated and focused the general concepts and methodology of the reactions in continuous mixtures [62]. McCoy and coworkers [63-70] applied the method to the coal decomposition. The general approach describes the chain length reduction using a method of moments, where the zeroth moment represents the molar concentration in the liquid phase and the first order moment is the massive concentration. A set of intrinsic kinetic parameters characterize the important reactions (initiation,  $\beta$ -scission, H abstraction, termination, re-polymerization). Recently, Kruse and Broadbelt applied the method of moments to the degradation of PS [71]. They developed different models with different degree of detail in the kinetic description, predicting the molecular weight decrease and styrene evolution during degradation.

This work presents and is limited to a review of the activity developed by our research group in the detailed modeling of pyrolysis of plastics [72-75]. We described the kinetics of the degradation of the most common plastics PE, PP, PS, PVC and recently, to further extend our approach, we studied also polychloroprene (PCP). Two different approaches were followed according to the complexity of the system and particularly according to the presence of significant amount of cross-linking reactions, which dramatically expand the number of species. Another peculiar characteristic of the proposed models is the wide range validation. We compare the theoretical results with many experimental data to increase the reliability of the model.

### **Kinetic mechanism**

Pyrolysis of plastics like PE, PP, PS, PVC and PCP is a liquid phase chain radical mechanism, at least at temperatures higher than 200 °C. Figure 1 shows the experimental results of thermogravimetric analyses carried out at 10 °C/min. Some differences are quite evident and the polymers can be divided in two classes according to their pyrolysis behavior. PE, PP and PS (panel a) have similar weight loss curves, quite steep (the polymer is volatilized in about 100 °C) and no residue is found at the end of the experiment. The degradation pathways refer to depolymerization reactions with a continuous chain length reduction.

PVC and PCP (panel b) show a more complex behavior. The pyrolysis spans over a wider range of temperatures (from ~ 250 °C up to ~ 550 °C) and proceeds through two main steps. Moreover the sample has a residual amount of about 20-25%.



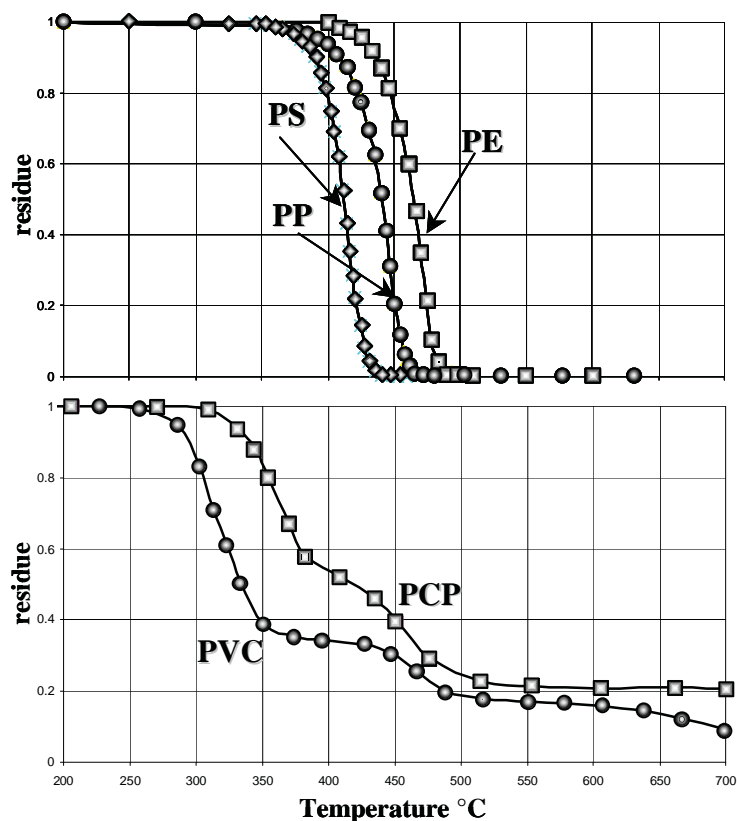

**Figure 1. TG experimental data for different polymers (heating rate: 10°C/min) .**

We adopted two different approaches in modeling these two classes of thermal decomposition. PE, PP and PS which do not present products from cross-linking reactions, that can be consequently neglected, are assumed to decompose according to families of homologous species with different chain length.. PVC and PCP, which contain Cl as a further element besides C and H, decompose in more complex way with the formation of polyaromatic hydrocarbons and char. The growth of these condensed species involves a large amount of intermediates and isomers. Therefore it is not convenient to handle the kinetic modeling of chlorinated plastic pyrolysis with a completely detailed approach. This very large number of intermediate and final components strongly suggests that

the whole mechanism should be described with a properly selected and limited set of reference lumped species, which characterize the functional group of the molecules.

In this work, we are interested in the kinetics and we do not take into account transport phenomena. The thermal degradation of plastics is conveniently described in terms of intrinsic kinetics, in which heat and mass transfer limitations are not included. Some investigations about bubble formation inside the melt were only discussed for PE pyrolysis [73].

At the base of the developed models, there is the estimation of the ‘fundamental’ rate constants, which rule the pyrolysis process. The kinetic parameters of these liquid phase reactions are directly derived from the parameters of analogous gas phase reactions, properly corrected to take into account the transposition in the liquid phase, where necessary:

$$k_{\text{liq}} = k_{\text{gas}} \exp\left(\frac{-\Delta G_{\text{gas} \rightarrow \text{liq}}}{RT}\right) = k_{\text{gas}} \exp\left(\frac{-\Delta H_{\text{gas} \rightarrow \text{liq}}}{RT}\right) \exp\left(\frac{\Delta S_{\text{gas} \rightarrow \text{liq}}}{R}\right)$$

These corrections become significant mainly for reactions with high activation energies [76]. Corrections are also applied to termination reactions to take into account the diffusive limitations to effective collisions and recombinations of radicals.

The correction of the activation energy for the transposition to the liquid phase is related to the number of carbon atoms ( $n_c$ ) characterizing, as per free volume theory, the flow unit for the polymer diffusion. The polymer molecules move through the liquid phase courtesy of the coordinated migration of segments of the polymer chain. The critical volume (or length) for this migration of a polymer chain is the volume of this jumping unit, which is only a small segment of the complete chain. This length ( $n_c$ ) can be estimated from the energy ( $E_v$ ) required for the mobility of the polymer segment and is experimentally measured as a function of the temperature.

The heat of evaporation is conveniently estimated from the Trouton-Meissner rule [77, 78].

$$\Delta H_{ev} \cong 21 T_{ev}(n_c) \cong 765 n_c^{1/2} \quad (\text{kJ kmol}^{-1})$$

The entropy correction is due to the loss of degrees of freedom and can be estimated on the basis of the translation and rotational contributes:

$$? S_{\text{liq-gas}} \cong -9.9 \text{u.e.}$$

A general expression of the kinetic parameters of the termination reactions in the condensed phase becomes:

$$k_t = 10^{12.8} \frac{T}{400} V_s \exp\left(\frac{-E_v}{RT}\right) \Phi^2 \quad (1 \text{ mol s}^{-1})$$

where  $\Phi^2$  is a global correction factor, which takes into account the symmetry, resonance, steric and surface effects [79].  $V_s$  is the molar volume of the flux unit

$$V_s = \frac{W}{\rho}$$

where  $W$  is the molecular weight of the flux unit and  $\rho$  is the liquid density, which can be reasonably considered constant during the process. As already discussed, the polymer molecules move through the liquid phase via the coordinated migration of segments of the polymer chain. In the particular case of alkyl aromatic radicals coming from PVC or PCP, the polyaromatic structure inhibits the migration of small segments and the flux unit is assumed as the whole radical.

The contributions of initial decomposition and termination reactions are of minor importance in the overall balances when compared with the chain propagation ones. Nonetheless, initiation and termination reactions are critical in defining the overall radical concentration and consequently the global reactivity of the system.

#### PE, PP and PS DEGRADATION MODELS

As already mentioned, PE, PP and PS decompose according to a simple depolymerization process. As a reference for this class of polymers, PP chain radical reactions are simply described by the following reaction classes:

1. Initiation reactions, to form the first radicals:

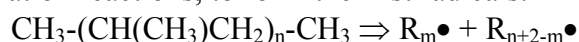

2. Propagation reactions of intermediate radicals:

2A)  $\beta$ -scission of radicals to form unsaturated molecules and smaller radicals



2B) Alkyl radical isomerization via (1-4) and (1,5) H-transfer

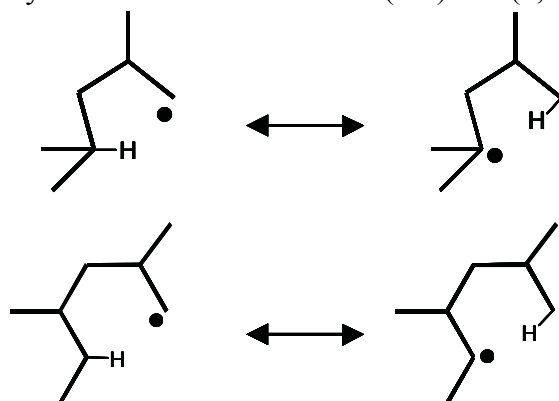

2C) H-abstraction reaction (H-metathesis) on the polymer chain



3. Termination reactions (radical recombinations)

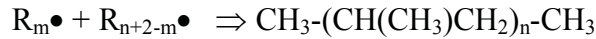

The reactions here sketched are representative of the whole class. As an example termination reactions occur between all the propagating radicals formed during the degradation and not only between those coming from initiation reactions.

Other reaction classes can be reasonably ignored.

The main products from the polymer (PE, PP or PS), always described with an alkane backbone ( $P_n$ ), are alkane, alkene ( $O_n$ ) and dialkene backbones ( $D_n$ ) through the following reaction sequence:

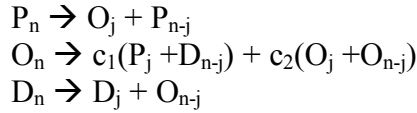

where  $j$  varies along the carbon chain of total length  $n$ . The two constants  $c_1$  and  $c_2$  depend on the presence of resonant position and intramolecular backbiting reactions [73]. Smaller alkane and alkene species are produced through  $\beta$ -decomposition reactions of the radicals formed by H-abstraction reactions on the alkane and alkene backbones. The alkenes can also be formed from the dialkenes. Ultimately,  $\alpha,\omega$ -dialkene backbone species are produced in the same way from heavier alkenes and dialkenes. A large number of molecular and radical components are involved and it is possible to reduce the overall dimension of the problem with appropriate lumping procedures.

By introducing the steady state hypothesis of the intermediate radicals, the total radical concentration  $[R]$  can be simply evaluated on the basis of initiation and termination reactions:

$$\begin{aligned} \frac{d[R]}{dt} &= 2 k_s [P] - 2 k_t [R]^2 = 0 \\ [R] &= \sqrt{\frac{k_s [P]}{k_t}} \end{aligned}$$

where  $k_s$  and  $k_t$  are the rate constants of the initiation and termination reactions respectively, and  $[P]$  is the total polymer concentration, including alkane, alkene and dialkene backbone molecules. The presence of double bonds favors the initiation reactions and this fact is taken into account by reducing the activation energy, because of the allylic resonance of the resulting radical.

The rate constant of the global propagation reaction ( $K_p$ ) governs the decomposition process and can be easily deduced from the mass balance on the radical [74]:

$$K_p = \frac{k_\beta k_f}{k_\beta + k_r \rho / m_0}$$

where  $k_\beta$  is the rate constant of the  $\beta$ -decomposition reaction and  $k_f$  and  $k_r$  are the kinetic parameters of the forward and reverse H-abstraction reactions.  $\rho$  is the polymer density, estimated at an average temperature and assumed constant during the degradation process.  $m_0$  is the molecular weight of the chain unit.

In order to give a more complete picture, we will only report the estimated values of the global propagation reaction  $K_p$ , respectively in the case of PE, PP and PS:

$$\begin{aligned} K_p^{PE} &= 2.5 \times 10^{12} \cdot \exp\left[-\frac{14600}{T}\right] && (\text{m}^3 \text{ kmol}^{-1} \text{ s}^{-1}) \\ K_p^{PP} &= 7.9 \times 10^{12} \exp\left[-\frac{14500}{T}\right] && (\text{m}^3 \text{ kmol}^{-1} \text{ s}^{-1}) \\ K_p^{PS} &= 10^8 \cdot \exp\left[-\frac{6800}{T}\right] && (\text{m}^3 \text{ kmol}^{-1} \text{ s}^{-1}) \end{aligned}$$

Despite the major differences in the kinetic parameters, the rate constants of the two apparent propagation reactions of PS, PP and PE are quite similar in the temperature ranges of interest. The lower activation energy of PS is due to the preferential formation of the long lived resonantly stabilized radicals.

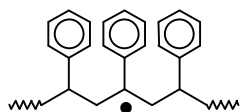

The lower frequency factor is mainly related to steric hindrance of the aromatic rings. H abstraction reactions include both intermolecular and intramolecular or backbiting reactions. When compared with the analogous reactions in the gas phase, the latter are inhibited due to the higher density of the liquid phase which favors the bimolecular interactions. It should also be noted that the H-abstraction reactions in the liquid phase are much faster than  $\beta$ -decomposition reactions. In the typical temperature conditions (600-800 K), the  $\beta$ -decomposition reaction becomes the rate-determining step and the smaller radicals formed generate the parent molecule before undergoing a new  $\beta$ -scission. A particular case of  $\beta$ -scission reactions of PS are the unzipping reactions, which play a fundamental role and explain the formation of large quantities of the monomer. Terminal methyl groups are neglected, both for initial decompositions and for H-abstraction reactions, due to their lower reactivity and presence.

The mass balance equations of all the reacting and final species (S) are expressed in a very general form with disappearance terms (decomposition to lower species or isomerization due to back biting) and formation terms from all the heavier species:

$$\frac{dS_n}{dt} = -a_1 K_p [R] S_n + a_2 K_p [R] \sum_{i=n+a_3}^{\infty} S_i$$

This equation applies to all the species either from PE, PP and from PS. The constants  $a_1$ ,  $a_2$  and  $a_3$  depend on the species and on chain length. Even though formally quite simple, the equations remain very complex because of the large number of species involved. All the details of these balance equations were already discussed in the papers previously referred [72, 73, 80].

Alkane backbone	Alkene backbone	Dialkene backbone	
			<b>Polyethylene</b>
			<b>Polypropylene</b>
			<b>Polystyrene</b>

**Table 2. Families of homologous species of different plastics**

During thermal degradation, light products form a new gas phase in the reacting system. It is then necessary to distinguish the molecules in the liquid phase from the gaseous ones. Boiling temperatures are estimated on the basis of the molecular weight. Species with boiling points

lower than the system temperature are instantaneously assumed to be in the gas phase. Reactions in the gas phase are usually ignored due to the low temperatures involved and consequently the mass balance equations of the gas species contain only the formation terms. To account for successive pyrolysis reactions in the gas phase, it would be necessary to define the overall conditions of this gas stream (temperature, residence time, etc.).

The polymers are distinguished in terms of reference families of homologous species. Three families can be individuated in the case of PE and PP (alkane, alkene and  $\alpha,\omega$ dialkene backbones). Five different families of species were introduced for PS because its degradation products have to characterize the different chain ends of the different backbone structures, as shown in table 2. Dialkene backbone species with only one aromatic ring is obviously not considered in the model.

Initial conditions are needed to solve the resulting system of ordinary differential equations. It was assumed that only alkane backbone species are present at the outset. The initial molecular weight distribution curve is assumed on the basis of Schultz's "most probable distribution" [81]. In order to reduce the number of species and consequently the number of equations, the maximum chain length  $N$  is assumed when the distribution reaches 99.9% of the total initial mass. The resulting dimension of the overall differential system of mass balance is thus either  $3 \times N$  for PE and PP and  $5 \times N$  for PS.

The solution of the overall resulting system, which can be very large (up to about 200,000 equations for high molecular weights) is obtained after a numerical integration through an implicit multi-step Adams-Moulton method [82].

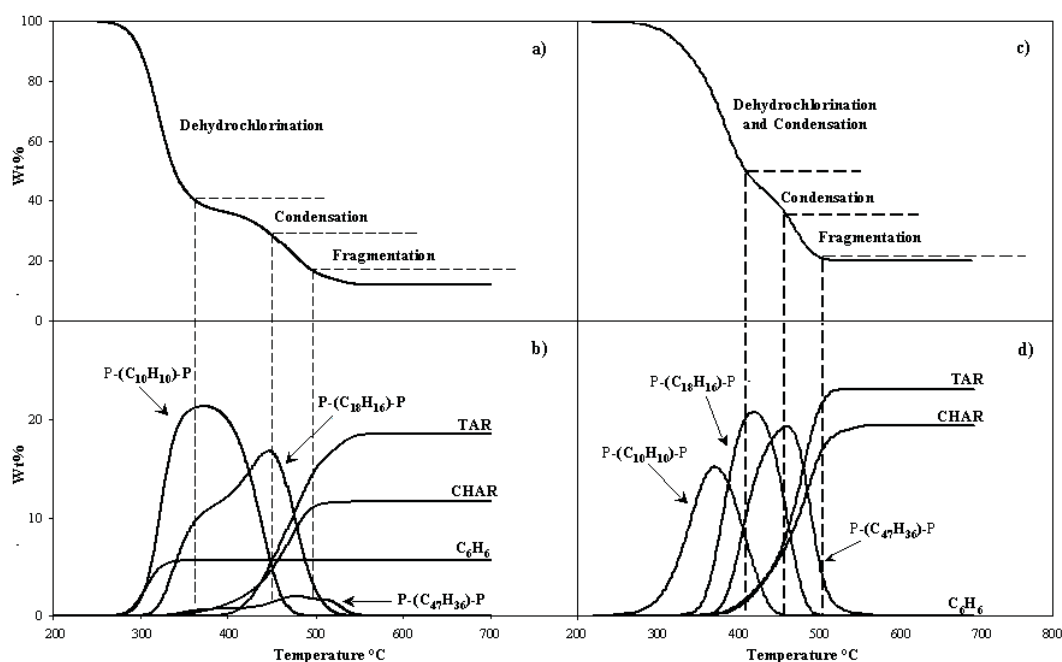

**Figure 2. Predicted dynamic TGA with an heating rate of 10°C/min:**

**Panel a) PVC residue (%wt) behavior and identification of the main thermal decomposition phases**

**Panel b) Benzene, PAH and char formation profiles from PVC. The TAR fraction represents the total amount of volatile aromatics**

**Panel c) PCP residue (%wt) behavior and identification of the main thermal decomposition phases**

**Panel d) Benzene, PAH and char formation profiles from PCP. The TAR fraction represents the total amount of volatile aromatics**

The proposed models were validated through comparison with several experimental data on pure PE, PP and PS pyrolysis. TG analysis, both dynamic and isothermal, in particular was

used by measuring the weight loss histories of samples subjected to properly defined heating rates and pressure conditions.

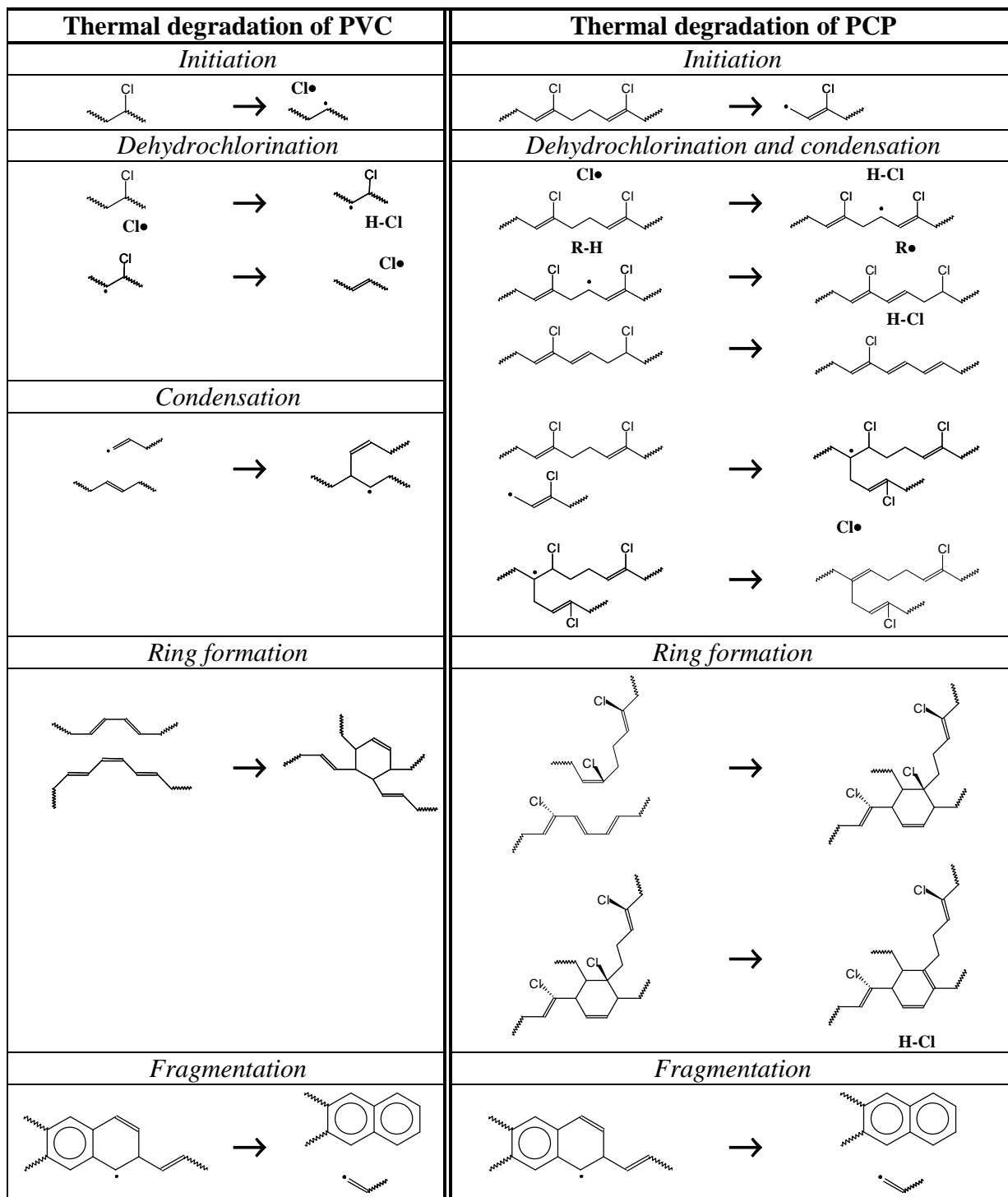

Figure 3. Sketched mechanisms of the main radical chain propagation steps of PVC and PCP

Because of the heavy computing times and especially to the memory required, owing to the initial high molecular weights, a lumping procedure has been introduced [83-85]. It is based on the grouping of the long species into lumps. It is possible to define the critical length beyond which species are grouped and the number of species of each group. This approach strongly reduces the calculation time without a significant effect on the predicted results. This simplification becomes extremely important when the kinetic scheme is used for the

simulation of real reactors, where mass and heat transport phenomena plays an important role and consequently the number of balance equations increase accordingly.

#### PVC, PCP DEGRADATION MODELS

All the researchers agree on the presence of two main degradation steps of PVC and PCP polymers, as clearly shown in figure 2. Initially dehydrochlorination forms HCl and polyene structures. During this phase, benzene and some naphthalene and phenanthrene are also formed through Diels Alder reactions and successive dealkylation of polyene molecules.

Then, when Cl has been quantitatively released from the melt, the polyene molecules rearrange and through cyclization and cross-linking reactions, form alkyl aromatic hydrocarbons and char residues. The main difference in the two polymer degradation is that in PVC case the two steps are more separated, whilst PCP shows an overlapping between dehydrochlorination and the successive cross-linking phase. Moreover, during the dehydrochlorination of PCP unzipping reactions further complicate the reacting system. The main paths of the mechanism are sketched in fig. 3.

The chlorinated plastic degradation process is thus very complex, compared with the degradation of polymers such as PE, PP or PS. Not only do they contain Cl as a further element, but the complexity of cross linking reactions and the successive formation of polyaromatic hydrocarbons and char also play a significant role. In fact, char and carbonaceous residues up to ~15-20% wt. can be obtained depending on the operating conditions. The growth of these polyaromatic species and char formation involves a large amount of intermediate species and isomers. Therefore it is not convenient to handle the kinetic modeling of PVC and PCP pyrolysis with a detailed approach similar to the one already adopted for the decomposition of PE, PP and PS.

This very large number of intermediate and final components strongly suggests that the whole mechanism should be described with a properly selected and limited set of reference lumped components. The resulting semi-detailed kinetic mechanism of each polymer is constituted by about 40 species and/or pseudocomponents, which are assumed to be representative of the whole system.

They characterize the typical species involved in the different degradation phases and can be classified into four major groups:

1- Real species (molecules and radicals):



2- Linear reference pseudospecies (molecules and radicals):

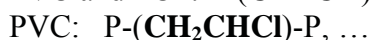
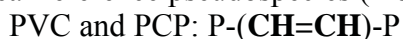

3- Aromatic and char pseudospecies (molecules and radicals):



4- Chlorinated Aromatic and char pseudospecies (molecules and radicals)

Reference components of class 3 and 4 are the same for PVC and PCP.

Table 3 reports a few reference components involved in PVC and PCP degradation model.

The initial PVC polymer is simply represented by the chlorinated reference unit P-(**CH<sub>2</sub>CHCl**)-P, and PCP by the corresponding P-(**CH<sub>2</sub>CH=CClCH<sub>2</sub>**)-P. The successive steps of degradation form polyene molecules and these species, all of which have different molecular weights, are represented by the alkene reference unit: P-(**CH=CH**)-P. The reference species or functional group reacting units (reported in bold characters in the brackets) are placed inside the polymer chain, represented here by the Ps at the beginning and end. Intermediate species during the dehydrochlorination phase are other reference units which present either Cl or double bonds in the structure. H or Cl abstractions from these

pseudocomponents form the corresponding radicals. No steady state assumption is then adopted.



PVC	PCP	PVC and PCP
 <p>P-(CH<sub>2</sub>CHCl)-P</p>	 <p>P-(CH<sub>2</sub>CH=CClCH<sub>2</sub>)-P</p>	 <p>P-(CH=CH)-P</p>  <p>C<sub>12</sub>H<sub>10</sub></p>  <p>P-(C<sub>47</sub>H<sub>36</sub>)-P</p>  <p>C<sub>14</sub>H<sub>10</sub></p>  <p>P-(C<sub>18</sub>H<sub>16</sub>)-P</p>  <p>P-(C<sub>10</sub>H<sub>10</sub>)-P</p>  <p>CHAR</p>

Table 3. Formula and structure of the relevant reference components.

Cross-linking reactions between polyene molecules lead to alkyl aromatic intermediates, which can further condensate and grow into char. Reference pseudocomponents are then introduced according to the different number of aromatic rings and the possible presence of Cl. The degradation of these polymers can be described on the basis of the main reactions, which occur in the system and a small set of reference kinetic constants. The whole mechanisms are reported elsewhere and include about 200 reactions [75]. In particular the following class of reactions are included:

#### Radical initiation reactions

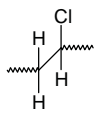
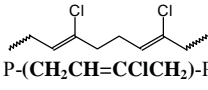
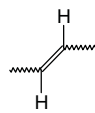
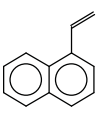
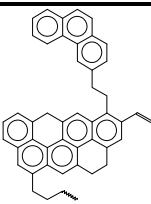
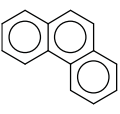
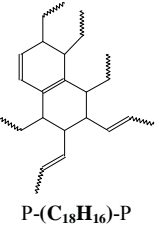
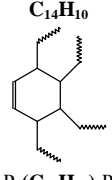
C-Cl is the weakest bond in PVC molecule and consequently the initiation step is:

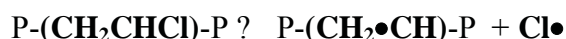

PCP molecule presents three possible homolytic cleavage sites: C-H allyl bond, C-Cl vinyl bond and C-C allyl bond. The unimolecular transition state theory allows to approximate bond energies to the associated cleavage activation enthalpy. Consequently, PCP pyrolysis is characterized by the C-C cleavage:

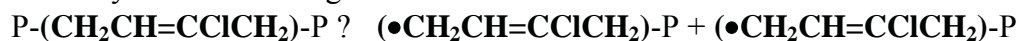

#### Radical termination reactions

Termination reactions involve the three families of radicals active in the system: Cl, alkyl radicals and alkylaromatic radicals. Because of the high reactivity and mobility of chlorine radicals in the liquid phase, the termination reactions do not require activation energy, whilst the frequency factors decrease increasing the molecular weight of the other terminating radical. The recombination reactions of two alkyl and alkyl aromatic radicals are estimated by correcting the collisional constant of the gas phase reactions to take into account the diffusive limitations of the liquid phase, according to what already previously discussed.

#### Dehydrochlorination

Dehydrochlorination is the first step of the degradation process and explains the initial weight loss of fig. 2. As clearly reported in the literature [86, 87], both molecular reactions and radical propagation reactions contribute to this HCl release. The former is represented by a single reaction, which plays a fundamental role at low



temperatures (<200 °C). The latter involves a chain radical reaction mechanism including several intermediate components and becomes relevant at temperatures higher than 200 °C .

In the case of PVC both these types of reactions straight occur:

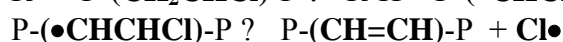
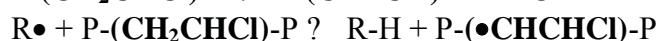
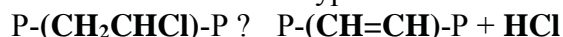

In the case of PCP the direct dehydrochlorination is not possible without an isomerization step. In the kinetic scheme it has been assumed that the initial monomeric unit can be abstracted from radical species present in the melting phase forming a resonantly stabilized allyl radical:

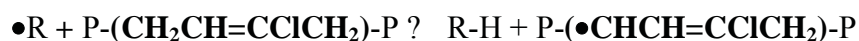

This resonantly stabilized pseudo-radical pseudocomponent  $P-(\cdot\text{CHCH}=\text{CClCH}_2)-P$  leads to a structure more favored for molecular dehydrochlorination

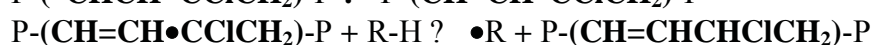
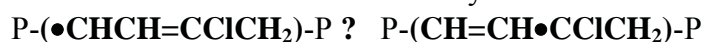

$P-(\text{CH}=\text{CHCHClCH}_2)-P$  can easily release a HCl molecule via unimolecular reaction. Also from PCP, short polyene sequences  $P-(\text{CH}=\text{CH})-P$  are formed in agreement with the experimental evidences [88, 89].

#### *Substitutive addition reactions*

The presence of a large number of double bonds in the initial molecule of PCP makes this polymer subject to possible addition reactions:

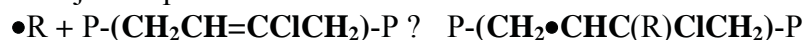

This crosslinking reaction is followed by the  $\beta$ -scission with the formation of  $\text{Cl}\cdot$ :

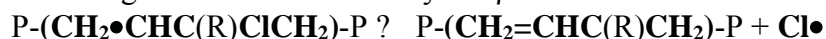

Where R can be either a hydrogen atom or a more complex radical. The successive H-abstraction of  $\text{Cl}\cdot$  forms HCl. This dehydrochlorination pathway plays an important role especially at low temperatures and is responsible of the initial reticulation occurring during the first degradation step.

#### *Abstraction Reactions*

The different radicals are capable of stabilizing themselves, mainly through H or Cl abstraction reactions which form a stable molecule. The H abstraction reactions are extremely relevant. In fact, the kinetic parameters reported in the literature clearly indicate that H abstractions dominate and Cl abstraction can be disregarded without significant errors [90]. The different reactivity of the intermediate radicals reflects their different stabilities. Allyl radicals are more stable than secondary alkyl radicals, which are more stable than vinyl radicals and consequently vinyl radicals are the most reactive.

#### *$\beta$ decomposition reactions*

H abstraction reactions propagate the reaction chain, but do not change the mean molecular weight of the system. On the contrary,  $\beta$ -decomposition reactions are initially responsible for the chlorine formation and for the subsequent reduction of the chain length. The bond energy of C-Cl is lower than that of C-C and for this reason, the release of Cl radicals is favored in comparison with the formation of primary radicals.

$\beta$ -decomposition reactions with a C-C bond cleavage form the terminal vinyl radicals  $(\cdot\text{CH})-P$ . This reference unit plays a key role in the formation of cross linked structures and in the molecular weight growth of polycondensed aromatics

#### *Unzipping reactions*

Chloroprene monomer and dimer are released during the first decomposition step of PCP. The selectivity to these products increases at higher temperature [91]. Chloroprene formation is explained by a depolymerization radical mechanism, which involves chain end allyl radicals.

The model then assumes that monomer is a lumped species, which describes both chloroprene and its dimer and the reacting pathway is expressed by the unzipping unimolecular reaction:

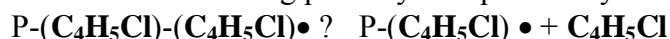

#### *Benzene formation and initial reticulation processes*

As already mentioned, polyene molecules formed during DHC, can successively undergo cyclization reactions. The net result of these reactions is the formation of aromatic and alkyl aromatic species on the one hand, and the reticulation and cross-linking of the polymer structure on the other. The formation of benzene and aromatic products is a function of the residual chlorine in the polymer. As already mentioned, this complex reacting system, whose molecular weight spans various orders of magnitude with a large number of intermediates, is described on the basis of a limited number of lumped or reference components.

These reactions can be both intermolecular and intramolecular and in this case too, moreover they can proceed via molecular and radical reactions. The relative role of these unimolecular and bimolecular processes is not completely clarified in the literature [92-94].

#### Unimolecular reaction

As soon as the DHC process forms polyene structures, molecular cyclization takes place through six center Diels Alder reactions in the reacting system. Unimolecular (or intramolecular) reaction is entropically favored but requires a higher activation energy. Consequently, at low temperatures, bimolecular condensation prevails and the unimolecular reaction becomes significant only at temperatures higher than 500 °C.

The competition between benzene and alkylaromatic formation is ruled out by the residual Cl in the  $\alpha$ -position of the side chains. As a matter of fact, the electronic delocalization effect of Cl reduces the C-C bond energy. This is the reason why benzene is formed mainly from PVC and during the first degradation steps when a reasonable amount of Cl is present in the chain.

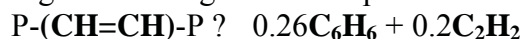

$C_2H_2$  is a lumped pseudocomponent, which represents several gas species. Gas species (partially chlorinated  $C_2$ - $C_4$ ) are the products of the dealkylation reaction in this phase. With the progressive Cl depletion from the chain and the loss of its delocalization activity, the molecular cyclization reactions give rise to alkyl-aromatic components, whose successive fate is a further condensation and growth.

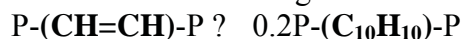

The competition between benzene and alkyl aromatic formation is empirically described by means of an apparent increase of the activation energy with the extent of the dehydrochlorination process.

#### Bimolecular reaction

Diels Alder bimolecular reactions favor the formation of cyclic species as well as a continuous cross-linking and condensation of the reacting species. When large amounts of Cl are still present in the chain, these reactions too are followed by successive dealkylation reactions with the final formation of benzene.

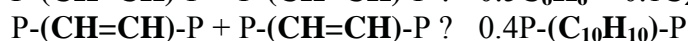
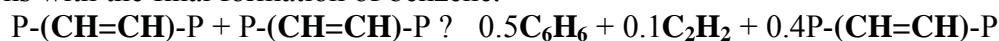

In this case too, a proper correction accounts for an apparent increase in the activation energy with the dehydrochlorination process.

#### *Condensation*

As is clear from Figure 2, the TGA curve plateaus between 350-450°C. During this phase the chemistry of the system is governed by the significant and progressive formation of polycondensed aromatic intermediates. These successive cyclization reactions of polyene species take place both via radical and molecular mechanisms. As already mentioned, the formation of benzene is mainly observed during the initial DHC phase and is strongly related to Cl content in the side chains. The progressive cross-linking of the polymer matrix and the growth

of the molecular aromatic structures characterize the formation of char residues. Condensation reactions of alkyaromatic molecules form polyaromatic hydrocarbons (PAH), thereby increasing the molecular weight of the polymer with a continuous reduction of H content and without significant formation of volatiles. Panel b of figure 2 shows the predicted evolution of aromatic pseudospecies and the formation of heavy components along the reaction time. Benzene is mainly released in the initial phase of PVC pyrolysis. When most of the dehydrochlorination has occurred for PVC or partially simultaneously for PCP, alkylbenzenes are formed initially and these progressively condense to form PAH and finally the char residues. The progressive growth of the aromatic clusters is described on the basis of just three different aromatic pseudo species: P-(C<sub>10</sub>H<sub>10</sub>)-P, P-(C<sub>18</sub>H<sub>16</sub>)-P and P-(C<sub>47</sub>H<sub>36</sub>)-P. The successive growth of PAH takes place through the following lumped cyclization reactions:

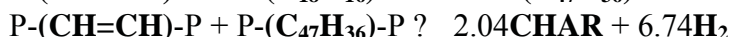
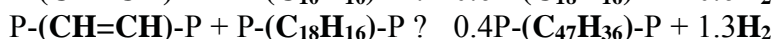
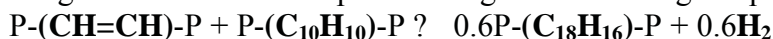

Similar radical reactions represent the possible addition reactions of aromatic radicals on aromatic structures with the corresponding growth of the aromatic cluster. Analogous results are also obtained through intramolecular reactions with Diels Alder molecular paths.

A further path towards the growth of PAH is ruled out by the addition of the primary radicals on double bonds. Successive dehydrogenation reactions increase the stability of the polyaromatic species.

Heavy dehydrogenated molecules are also formed from the cyclo-addition reactions (and successive dealkylation) of alkyaromatic radicals on the double bonds of the side chain of alkyaromatics. These reactions are the main responsible for the final formation of the char residues:

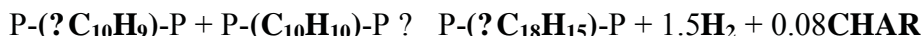

#### *Fragmentation and TAR formation*

At temperatures higher than ~450°C, a new change in the TGA slope in Fig. 2 is observed. This is explained by the tar and volatiles released by the liquid phase as a result of the condensation and dehydrogenation reactions with deep dealkylation. Most of the resulting aromatic species are no longer linked to the polymeric chains and can volatilize as secondary tar products, while the char structures' concentration increases. The hydrogen content of the char is very low as observed in the typical residue of PVC pyrolysis. Only a few reference species are assumed to describe this degradation step also.

H abstraction reactions of different radicals on the alkyaromatic species are particularly selective on the benzyl-like positions, thus forming resonantly stabilized radicals (RSRs). This stability increases with the number of polycondensed rings and the consequent electron delocalization. The main successive fate of these RSRs is a dealkylation process via β-scission as well as further condensations due to addition and recombination reactions. PAHs are then assumed with short alkyl side chains and/or vinyl groups. This assumption is experimentally confirmed by the gas evolution during tar formation [95]. Example of the lumped reactions are the following:

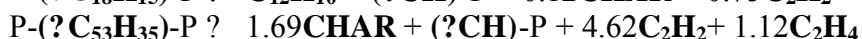
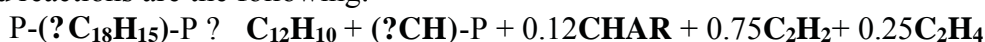

In the semidetalled approach adopted, C<sub>2</sub>H<sub>4</sub> and C<sub>2</sub>H<sub>2</sub> represent respectively the classes of hydrogenated and dehydrogenated gas species, lumping together also larger hydrocarbons. In facts, as experimentally observed [60], the hydrogen disproportionation can explain the formation of CH<sub>2</sub> groups in the aliphatic side chains. In this way, the system dehydrogenation proceeds releasing both directly hydrogen (during cyclization reactions) and hydrogen rich small hydrocarbons.

Light aromatic components leave the polymer melt as soon as they are formed. When the molecular weight of the PAH radicals increases, the corresponding reactivity decreases and both  $\beta$ -decomposition and H-abstraction reactions are less favored. On the contrary, addition and termination reactions become relevant and explain the char formation.

## Results and validation

Analyzing the results of the comparisons between predictions and experimental data, it has to be taken into account that in our approach we assume the polymer as ‘perfect’, i.e. neither additives, nor weak links (head-to-head positions, oxygen bridges or ramifications) are considered. On the contrary, from the experimental point of view in most of the cases the samples are commercial polymers with different levels of impurities. The different origin of the reported measurements makes the tests more significant, but it also allows to reduce the impact of systematic deviations eventually present in homogeneous experiments.

### WEIGHT LOSS (TG)

A first set of comparisons refers to the weight loss of polymers during TG experiments. In the following a few examples of both nonisothermal and isothermal measures are presented for the different plastics. The goal is mainly to show the reliability of the model spanning over quite large operative conditions. Figure 4 shows the comparison between predictions and measures of four different sets of data, carried out at atmospheric pressure and at different heating rates. The experimental uncertainties are highlighted by the two examples at 10 °C/min. The differences in this case seem quite large if observed at the same temperatures. At 475 °C the residue weight fraction moves from about 15% [74] up to about 55% [3]. On the contrary, looking at the same conversion, the uncertainty is lower than 20°C which is not too high. The general agreement of the model is quite good. The reactivity is well matched and the trend with the heating rate correctly reproduced.

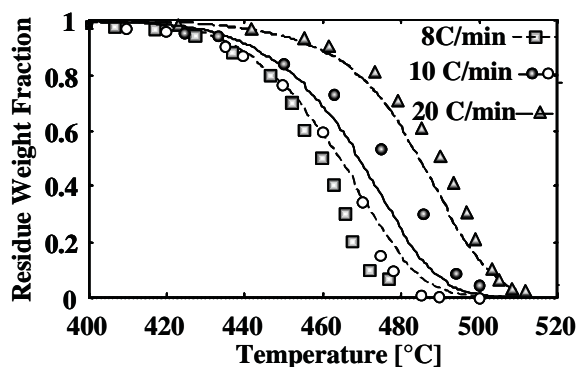

**Figure 4. TG curves of PE at different heating rates. Comparison between measures (marks) and calculations (lines). Two different sets experiments at 10 °C/min are reported [74].**

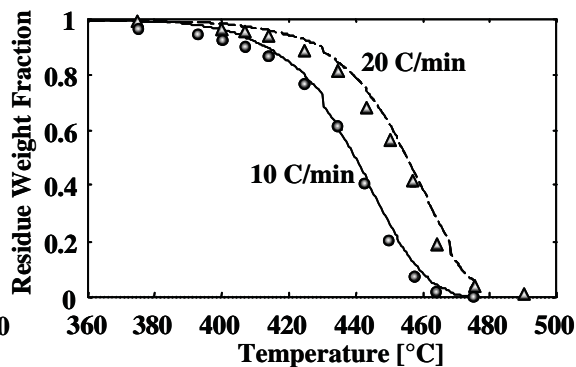

**Figure 5. TG curves of PP at different heating rates. Comparison between measures (marks) and calculations (lines) [74].**

Figure 5 shows the results of the comparison of PP thermogravimetries at atmospheric pressure and for two heating rates. The presence of a tertiary C atom in the PP backbone increases its degradation velocity when compared with PE. The product release is anticipated of about 30 °C both at 10 °C/min and 20 °C/min. The model is in a good agreement with the experimental results [74].

In fig. 6 the theoretical predictions are compared with isothermal data of PS pyrolysis at atmospheric pressure as reported by Bockhorn et al. [96]. The agreement is very good at 360, 400 and 410 °C. The intermediate isothermal curves at 370, 380 and 390 °C are slightly underpredicted.

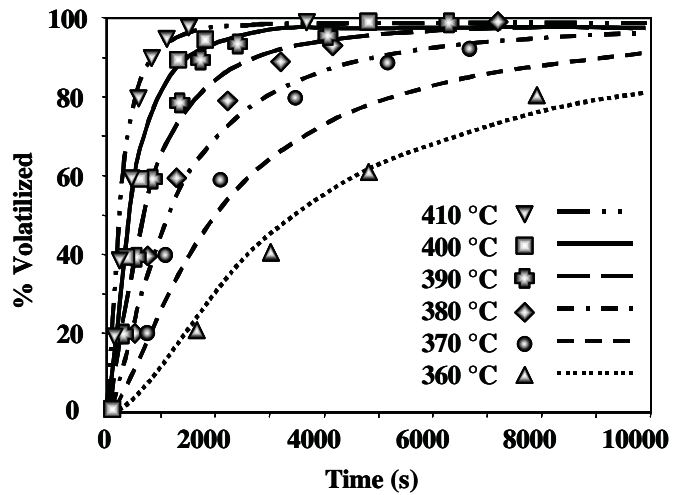

Figure 6. Isothermal TG curves of PS at different temperatures. Comparison between measures (marks) and calculations (lines). [96]

Figure 7 shows the comparison of the model results with 11 different measured dynamic TGA of PVC samples. The experimental results come from different research groups [60, 86, 94, 97-99] and are carried out at different heating rates, which span from 2 °C/min up to 40 °C/min. Whenever possible different measures with the same heating rates are reported to evidence the experimental uncertainties. The characteristic three phases of the polymer decomposition are quite clear and distinct. Dehydrochlorination starts at about 200-220 °C and proceeds quickly. At about 350-400 °C the TGA curve changes its slope and plateaus somewhat up to 420-450 °C, where condensation reactions occur.

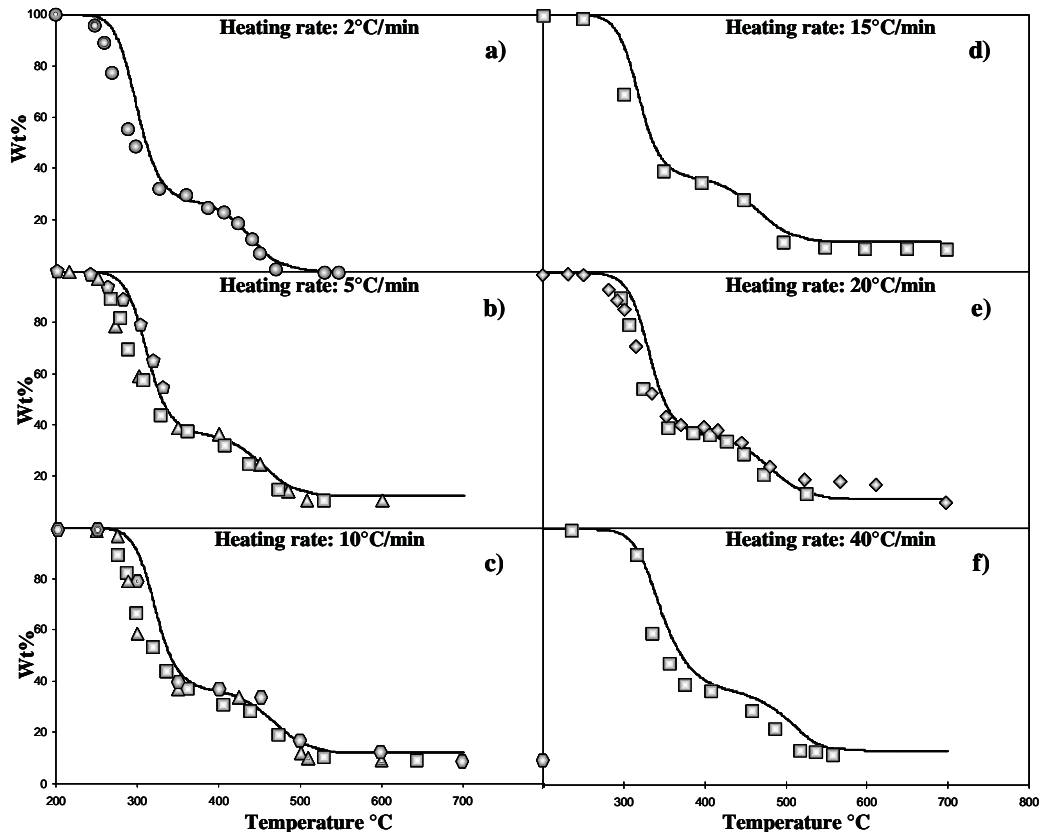

Figure 7 Dynamic TGA of PVC at different heating rates, predicted data are reported with line, experimental data with marks:

● [86] □ [60] ○ [94] △ [97] ◇ [98] ◊ [99]

At these temperatures the second important mass loss starts with dealkylation and dehydrogenation reactions and tar volatilization. Finally, above 500-500 °C, the char residue formed remains as fixed carbon. The model agrees quite well with the experiments in all the different phases and for all the different heating rates. Char formation too is properly predicted. It is important to observe that, in line with the experimental information, the data obtained at 2°C/min [86] are normalized by ignoring the total amount of residual at 500°C.

## PRODUCT DISTRIBUTION

Data about product distribution from thermal degradation of polymer are usually less available. Nevertheless, these measure are very important in order to define the chemical mechanism and above all to validate the kinetic assumptions. As a matter of examples three different results are discussed.

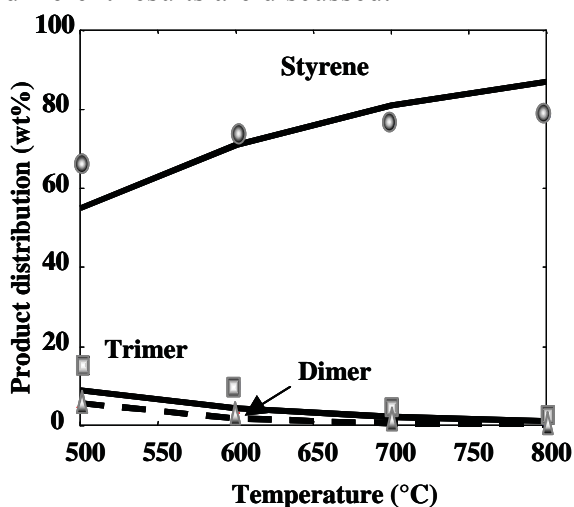

**Figure 8. Main Product distribution (wt %) from polystyrene pyrolysis. Comparison between model predictions and experimental data [9].**

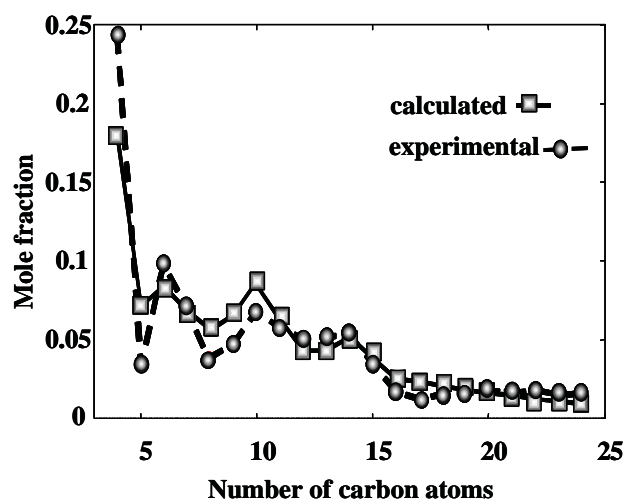

**Figure 9. Alkene product distribution from isothermal pyrolysis of PE at 600°C [73]. Comparison between experimental data and model results.**

Figure 8 refer to the main products from PS pyrolysis (monomer, dimer and trimer) at different temperatures. The model predicts quite well the general trends: increasing the temperature the selectivity toward depolymerization increases. Also quantitatively the amount of the components are quite correctly matched. Figure 9 shows the comparison of the gas product distribution of alkenes, coming from the pyrolysis of PE [73]. The model results were obtained considering also the mass transport inside the melt. As a matter of facts, experimental measures reveal that, larger amounts of shorter chain length products are present in light evaporated species. An explanation of this is that the molten polymer mass hindrance and viscosity make it difficult for longer volatiles to move inside and evaporate with the result that, on their way to the surface or to an internal gas phase, they have time to undergo additional crack reactions. In particular, the in-depth mass transfer proceeds through the formation of bubbles which move towards the surface and releasing light products and a simplified model was developed describing bubble nucleation, and their growth with the supply of light species coming from the surrounding molten polymer. Formed bubbles reach the surface of the molten polymer and release the gas products. In this simplified model, bubbles are assumed to grow and rise separately, so that bubbles at equal depth from the surface layer have the same size, the same negligible rising rate and the same internal composition. Such a stark simplification of the real process has been proved not to affect the quality of the degradation modeling under the conditions assumed so far, the bubbling being very modest due to the very small size of the sample.

The gas phase inside the bubble was considered not reacting, whilst the gas molecule diffusing in the melt in their moving to the bubble, can further crack because of the attack of the surrounding radicals. The agreement observed between the calculated results and the experimental data are quite good and support the adopted assumptions. Figure 10 shows the benzene yields from isothermal thermogravimetric data of PVC at 290 and 310 °C [100]. As already mentioned, the release of the formed benzene takes place in the first step of the degradation, simultaneously to the dehydrochlorination. The general agreement is quite good, even though the model tends to slightly emphasize the temperature effect.

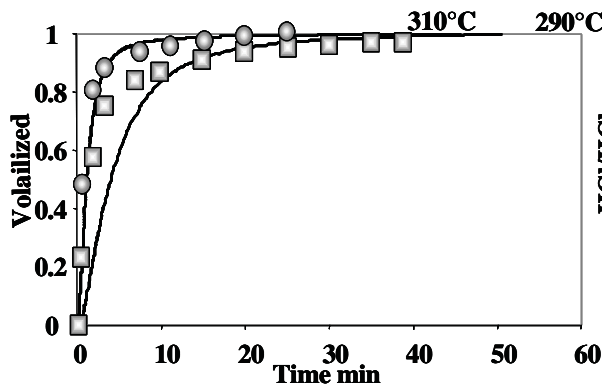

**Figure 10. Normalized benzene released during isothermal TGA of PVC. Comparison between predicted data are (lines) and experimental measures (marks) [100].**

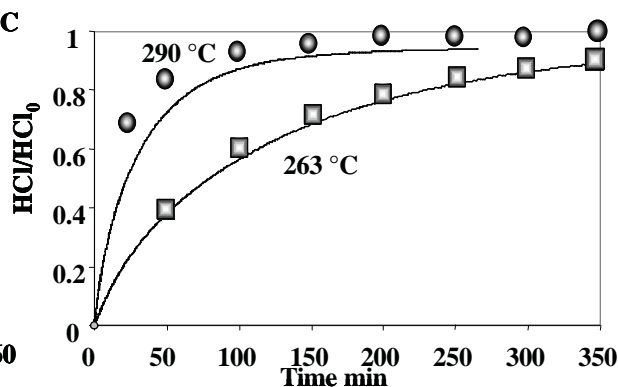

**Figure 11. Normalized HCl released during isothermal TGA of PCP. Comparison between predicted data are (lines) and experimental measures (marks) [101].**

The HCl released (related to the initial theoretical Cl in the polymer) from isothermal TGA of PCP at 263 and 290 °C is presented in fig. 11 [101]. Unfortunately a direct comparison with experimental data is not possible. The ‘experimental measures’ are estimated by the single step kinetics proposed by Gardner and McNeill for each of their experiment. The agreement is satisfactory and confirm the possibility of the proposed model.

## Conclusion

Standard power law kinetic models are not able to accurately describe all the phenomena of the complex system of reactions occurring during the plastic thermal degradation. The consequent estimated and literature kinetic parameters show a significant scatter.

This work shows that detailed kinetic models based on intrinsic rate parameters can accurately describe the pyrolysis process over wide operative ranges. Two different approaches have been presented. One considers families of homologous components with different chain length and is applicable to simpler polymer, where no cross-linking reactions occur. The latter assumes lumped pseudospecies representative of a large number of real components and allow to characterize the formation of char residue. The comparison with several experimental data of different common polymers (polyethylene, polypropylene, polystyrene, polyvinylchloride, polychloroprene), carried out in isothermal and nonisothermal conditions, at atmospheric pressure and in vacuum, referring to weight loss curves or to product distributions, confirm the applicability and reliability of the proposed models.

The approach has been recently extended to mixture of plastics [102] with quite good results. The pyrolysis of plastic mixtures, in which different polymers are decomposed together, offer an interesting advantage. As already shown in figure 1, single polymers in a mixture can partially decompose at different temperatures. This means that the decomposition of polymers and the separation of their products can be combined by means of a stepwise pyrolysis at

moderate temperatures [1, 103]. For this reason too, the characterization of the pyrolysis behavior of plastic wastes is of interest in the optimization of pyrolysis processes for the recovery of energy rich or valuable product fractions. The adopted modeling considers the presence of two completely separate liquid phases, one with a larger amount of PS and one where PE prevails. The internal compositions of each phase are evaluated on the basis of the mutual solubility of the two polymers. The radicals generated are only active inside their phase. A very good match between theoretical results and measures was reached by considering the solubility of the polymers.

Of course some more fundamental work, both from the theoretical and experimental point of view is still needed, especially in the proper characterization of the final products.

## Acknowledgment

The authors are in debt with many people who have been working in this research activity. We are particularly in debt with prof. M. Dente for being the initial promoter and for his continuous suggestions. We have also to acknowledge G. Bozzano and many students S. Fabini, R. Nava, C. Scassa, M. Perego, M. Pincioli, F. Pisano, F. Robecchi, M. Mehl, M. Nistler.

This work was supported by EU under the "HALOCLEANCONVERSION" project, contract n. G1RD-CT 1999-00082 and "HALOCLEANAPPLICATION" contract n. G1RD-CT-2002-03014.

## References

- [1] H. Bockhorn, J. Hentschel, A. Hornung, U. Hornung, *Chem. Eng. Sci.*, 1999. 54: p. 3043.
- [2] H. Bockhorn, A. Hornung, U. Hornung, *J. Anal. Appl. Pyrolysis*, 1999. 50: p. 77.
- [3] R. Knumann, H. Bockhorn, *Combustion Science and Technology*, 1994. 101: p. 285-299.
- [4] H. Bockhorn, A. Hornung, U. Hornung, *Proceedings of the Combustion Institute*, 1998. 27: p. 1343.
- [5] V. Cozzani, C. Nicolella, M. Rovatti, L. Tognotti, *Ind. Eng. Chem. Res.*, 1996. 35: p. 90.
- [6] J.A. Conesa, A. Marcilla, J.A. Caballero, R. Font, *J. Anal. Appl. Pyrolysis*, 2000. 58-59: p. 617.
- [7] R.W.J. Westerhout, J. Waanders, J.A.M. Kuipers, W.P.M. Van Swaaij, *Ind. Eng. Chem. Res.*, 1997. 36: p. 1955-1964.
- [8] W.G. Oakes, R.B. Richards, *J.Chem.Soc. London*, 1949. 619: p. 2929.
- [9] S.L. Madorsky, S. Straus, *J.Res.Nat.Bur.Stand.*, 1954. 53: p. 361.
- [10] H.H.G. Jellinek, *J.Polym.Sci.*, 1949. 4: p. 13.
- [11] H.H.G. Jellinek, *J.Polym.Sci.*, 1950. 4: p. 378-379.
- [12] L.A. Wall, S. Straus, *J.Polym.Sci.*, 1960. 44: p. 1960.
- [13] A. Atherton, *J.Polym.Sci.*, 1950. 5: p. 378.
- [14] T.E. Davies, R.L. Tobias, E.B. Deterli, *J.Polym.Sci.*, 1962. 56: p. 485.
- [15] S.L. Madorsky, *J.Polym.Sci.*, 1952. 2: p. 133.
- [16] N. Grassie, W. Leeming, *European Polymer Journal*, 1975. 11: p. 819.
- [17] G.G. Cameron, G.P. Kerr, *European Polymer Journal*, 1968. 4: p. 709.
- [18] G.G. Cameron, G.P. Kerr, *European Polymer Journal*, 1970. 6: p. 423.
- [19] B. Dickens, *J.Polym.Sci.*, 1982. 20: p. 1169.



- [20] D.A. Anderson, E.S. Freeman, *J.Polym.Sci.*, 1961. 54: p. 253.
- [21] H. Bockhorn, R. Knumann, *VDI Ber.*, 1993. 1090: p. 423-430.
- [22] R. Inoue, S. Ouchi, S. Yasuhira, *Chem.High.Polym.Jpn.*, 1956. 13: p. 38.
- [23] K. Kishore, V.R. Pai Verneker, M.N.R. Nair, *J.App.Polym.Sci.*, 1976. 20: p. 2355.
- [24] L.A. Wall, S.L. Madorsky, D.W. Brown, S. Straus, R. Simha, *J.Am.Chem.Soc.*, 1954. 76: p. 3430.
- [25] M. Gambiroza-Jukic, R. Cunko, *Acta Polym.*, 1992. 43: p. 258-260.
- [26] C.N. Cascaval, *Macromol. Chem.*, 1970. 131: p. 55-62.
- [27] B. Dickens, *J.Polym.Sci.*, 1982(20): p. 1065.
- [28] J.K.Y. Kiang, P.C. Uden, J.C.W. Chien, *Polymer Degradation and Stability*, 1980. 2: p. 113.
- [29] R.M. Fuoss, I.O. Salyer, H.S. Wilson, *J.Polym.Sci.*, 1964. 2(A): p. 3147.
- [30] S.R. Urzendowski, A.H. Gienther, *J.Thermal Analysis*, 1971. 3: p. 379-395.
- [31] K. Murata, T. Makino, Mitsui Zosen Giho, *Nippon Kagadu Kaishi*, 1975. 90: p. 62.
- [32] K. Saitoh, H. Nishizaki, *Hokkaido Kogyo Kaihatsu Shikensho Hokoku*, 1977. 30: p. 15.
- [33] B.V. Kokta, J.L. Valade, W.N. Martin, *J.App.Polym.Sci.*, 1973. 17: p. 1-19.
- [34] T. Sawaguchi, K. Suzuki, T. Kuroki, T. Ikemura, *Ind. Eng. Chem. Process D. Dev*, 1981. 26: p. 1267-1274.
- [35] T. Kuroki, T. Ikemura, T. Ogawa, Y. Sekiguchi, *Polymer*, 1982. 23: p. 1091-1094.
- [36] S. Straus, J. Wall, *J.Res.Nat.Bur.Stand.*, 1961. 65(A).
- [37] S.L. Madorsky, S.L. Rates, *J.Polym.Sci.*, 1953. 11((5)): p. 491-506.
- [38] D.E. Stuetz, A.H. Diedwardo, F. Zitomer, B. Barnes, *J.Polym.Sci.*, 1975. 13: p. 585-621.
- [39] S.L. Malhotra, J. Hesse, L.-P. Blanchard, *Polymer*, 1975. 16: p. 81-93.
- [40] M. Mucha, *J.Polym.Sci.*, 1976. Symp. 7: p. 25-31.
- [41] Y. Mehmet, R.S. Roche, *J.App.Polym.Sci.*, 1976. 20: p. 1955-1965.
- [42] T. Sawaguchi, T. Inami, T. Kuroki, T. Ikemura, *Ind. Eng. Chem. Process D. Dev*, 1990. 19: p. 174-179.
- [43] M. Day, J.D. Cooney, J.L. Fox, *J.Thermal Analysis*, 1994. 42: p. 397.
- [44] M. Day, J.D. Cooney, C. Klein, *J.Thermal Analysis*, 1993. 40: p. 669.
- [45] J.J.R. Mertens, E. Jacobs, A. Callaerts, A. Buekens, *Macromol. Chem., Rapid Commun.*, 1982. 3: p. 349-356.
- [46] J. Rychly, L. Rychla, *Journal of Thermal Analysis*, 1989. 35: p. 77-90.
- [47] Wu C-H, Chang C-Y, Hor J-L, *Waste Management*, 1993. 13: p. 221.
- [48] T.H. Risby, J.A. Yergey, J.J. Scocca, *Anal.Chem.*, 1982. 54: p. 2228-2233.
- [49] W. Klose, *Technischen Univeristat Berlin*, 1972. Berlin.
- [50] C. Vovelle, H. Melloteè, *European Polymer Journal*, 1983. 19: p. 387.
- [51] A. Sato, K. Kaneko, *J. Energy Heat Mass Transfert*, 1983. 5((4)): p. 323-338.
- [52] R. Miranda, J. Yang, C. Roy, C. Vasile, *Polymer Degradation and Stability*, 2001. 72: p. 469-491.
- [53] A. Marcilla, M. Beltran, *Polymer Degradation and Stability*, 1995. 48: p. 219.
- [54] R. Miranda, H. Pakdel, C. Roy, H. Darmstadt, C. Vasile, *Polymer Degradation and Stability*, 1999. 66: p. 107-125.
- [55] R. Miranda, H. Pakdel, C. Roy, C. Vasile, *Polymer Degradation and Stability*, 2001. 73: p. 47-67.
- [56] R. Simha, L.A. Wall, P.J. Blatz, *J.Polym.Sci.*, 1950: p. 615-632.
- [57] D.B. Anthony, J.B. Howard, *A.I.Ch.E.J.*, 1976. 22: p. 525.
- [58] G.S. Darivakis, J.B. Howard, W.A. Peters, *Combustion Science and Technology*, 1990. 74: p. 267-281.

- [59] J.A. Conesa, A. Marcilla, R. Font, J. Caballero, *J. Anal. Appl. Pyrolysis*, 1996. 36: p. 1-15.
- [60] G.M. Anthony, *Polymer Degradation and Stability*, 1999. 64: p. 353-357.
- [61] H. Bockhorn, A. Hornung, U. Hornung, P. Jakobstroer, M. Kraus, *Journal of Analytical and Applied Pyrolysis*, 1998b. 49: p. 97-106.
- [62] R. Aris, G.R. Gavalas, *Philosophical Transactions of the Royal Society of London*, 1966. 360: p. 351-393.
- [63] M. Wang, J.M. Smith, B.J. McCoy, *A.I.Ch.E.J.*, 1995. 41(6): p. 1521-1533.
- [64] G. Madras, J.M. Smith, B.J. McCoy, *Polymer Degradation and Stability*, 1997. 58: p. 131-138.
- [65] B.J. McCoy, G. Madras, *Chem. Eng. Sci.*, 2001. 56: p. 2831-2836.
- [66] G. Madras, B.J. McCoy, *Chem. Eng. Sci.*, 1997. 52(16): p. 2707-2713.
- [67] G. Madras, B.J. McCoy, *Journal of Colloid and Interface Science*, 2002. 246: p. 356-365.
- [68] G. Madras, S. Kumar, S. Chattopadhyay, *Polymer Degradation and Stability*, 2000. 69: p. 73-78.
- [69] B.J. McCoy, G. Madras, *Journal of Colloid and Interface Science*, 1998. 201: p. 200-209.
- [70] G. Madras, J.M. Smith, B.J. McCoy, *Polymer Degradation and Stability*, 1996. 52: p. 349-358.
- [71] T.M. Kruse, O.S. Woo, L.J. Broadbelt, *Chem. Eng. Sci.*, 2001. 56: p. 971-979.
- [72] T. Faravelli, M. Pinciroli, F. Pisano, G. Bozzano, M. Dente, E. Ranzi, *J.App.Polym.Sci.*, 2001. 60: p. 103-121.
- [73] T. Faravelli, G. Bozzano, C. Scassa, M. Perego, S. Fabini, E. Ranzi, M. Dente, *Journal of Analytical and Applied Pyrolysis*, 1999. 52: p. 87-103.
- [74] E. Ranzi, M. Dente, T. Faravelli, G. Bozzano, S. Fabini, R. Nava, V. Cozzani, L. Tognotti, *J. Anal. Appl. Pyrolysis*, 1997. 305: p. 40-41.
- [75] A. Marongiu, T. Faravelli, G. Bozzano, M. Dente, E. Ranzi, *J. Anal. Appl. Pyrolysis*, 2003. In Press.
- [76] S.W. Benson, *Thermochemical Kinetics (2nd ed)*. 1976, New York: John Wiley and Sons.
- [77] M. Dente, G. Bozzano, G. Bussani, *Computers and Chemical Engineering*, 1997. 21: p. 1125-1234.
- [78] M. Dente, G. Bozzano, M. Rossi, 1993: p. 163-172.
- [79] S.W. Benson, McGraw-Hill, New York, 1960.
- [80] E. Ranzi, M. Dente, T. Faravelli, G. Bozzano, S. Fabini, R. Nava, V. Cozzani, L. Tognotti, *Journal of Analytical and Applied Pyrolysis*, 1999. 40-41: p. 305-319.
- [81] U.W. Gedde, *Polymer physics*, Chapman & Hall, 1995.
- [82] A. Hindmarsh, ODEPACK, a systematized collection of ode solvers in scientific computing, R. S. Stepleman et al. (eds.), North-Holland, Amsterdam, 1983. 55.
- [83] P.G. Coxson, K.B. Bischoff, *Ind. Eng. Chem. Res.*, 1987. 26: p. 1239-1248.
- [84] P.G. Coxson, K.B. Bischoff, *Ind. Eng. Chem. Res.*, 1987. 26: p. 1251-1257.
- [85] J. Wei, J.C.W. Kuo, *Ind. Eng. Chem. Fundam.*, 1969. 8: p. 114-123.
- [86] H. Bockhorn, A. Hornung, U. Hornung, *Journal of Analytical and Applied Pyrolysis*, 1999. 50: p. 77-101.
- [87] R. Bacaloglu, M. Fish, *Polymer Degradation and Stability*, 1995. 47: p. 33-57.
- [88] I. Bela, J.P. Kennedy, S. Sebastian, K. Tibor, F. Tudos, *Journal of Polymer Science: Polymer Chemistry Edition*, 1980. 18: p. 1685-1692.
- [89] D.L. Gardner, I.C. McNeill, *European Polymer Journal*, 1971b. 7: p. 593.

- [90] E. Ranzi, M. Dente, M. Rovaglio, T. Faravelli, S.B. Karra, Chem. Eng. Comm., 1992. 117: p. 17-39.
- [91] P.D. Zeman, Analytical Chemistry, 1952. 24: p. 1709.
- [92] R.P. Lattimer, W.J. Kroenke, Journal of Applied Polymer Science, 1982. 27: p. 1355-1366.
- [93] R.P. Lattimer, W.J. Kroenke, Journal of Applied Polymer Science, 1982. 27: p. 1355-1366.
- [94] G. Montaudo, C. Puglisi, Polymer Degradation and Stability, 1991. 33: p. 229-262.
- [95] I.C. McNeill, L. Memetea, W.J. Cole, Polymer Degradation and Stability, 1995. 49: p. 181-191.
- [96] H. Bockhorn, A. Hornung, U. Hornung, The Twenty-Seventh International Symposium on Combustion, University of Colorado, Boulder, 1998.
- [97] M.J.P. Slapak, J.M.N. Van Kasteren, A.A.H. Drinkenburg, Computational and Theoretical Polymer Science, 1999. 10: p. 481-489.
- [98] V.P. Gupta, L.E. St. Pierre, Journal of Polymer Science, 1970. 8(A-1): p. 37-48.
- [99] Shibai Ma, Jun Lu, Jinsheng Gao, Energy & Fuels, 2002. 16: p. 338-342.
- [100] U. Hornung, *Bestimmung der Vergasungskinetik von Kunststoffen mit Hilfe eines isotherm betriebenen Kreislaufreaktors*. 1997.
- [101] D.L. Gardner, I.C. McNeill, European Polymer Journal, 1971a. 7: p. 569.
- [102] T. Faravelli, G. Bozzano, M. Colombo, E. Ranzi, M. Dente, J. Anal. Appl. Pyrolysis, 2003. In Press.
- [103] H. Bockhorn, A. Hornung, U. Hornung, P. Jakobstroer, Combustion Science and Technology, 1998. 134: p. 7-30.

# Thermal decomposition reactions of acrylonitrile-butadiene-styrene copolymer (ABS)

Marianne Blazsó

Research Laboratory of Materials and Environmental Chemistry, Chemical Research Center  
Hungarian Academy of Sciences, Pf. 17, H-1525 Budapest, Hungary, [blazso@chemres.hu](mailto:blazso@chemres.hu)

The recycling of ABS copolymers by pyrolysis is a suitable way for obtaining gases and oils of high calorific value from complex materials such as automotive shredder fraction or waste electric and electronic equipments. Nevertheless, the acrylonitrile component of these copolymers raises some problems by its conversion into a series of compounds containing nitrile group. The presence of nitrogen-containing compounds is disadvantageous for the utilisation of the gas and oil products as fuels, because of NO<sub>x</sub> formation under combustion.

In order to find solutions to these difficulties the detailed knowledge of the thermally induced chemical reactions taking place under pyrolysis in ABS copolymers should be useful. Through the understanding of the effects of various components of the plastic waste on the product distribution we may alter pyrolysis conditions and feed composition for obtaining utilizable products by pyrolysis.

## Chemical composition of ABS

Acrylonitrile-butadiene-styrene copolymers are generally synthesized by grafting poly(styrene-*co*-acrylonitrile) (SAN) to polybutadiene (BR, butyl rubber)<sup>1</sup>. In this way we cannot classify them either as block or random copolymers. The best description of the ABS chemical structure is that side chains of SAN random copolymer are attached to the polybutadiene chains randomly at the double bonds. The test material on which the experiments by analytical pyrolysis has been performed in our laboratory (purchased from Aldrich) consisted of acrylonitrile, butadiene and styrene monomer units of mass ratios  $a : b : s = 24 : 21 : 53$ .

## Thermal decomposition of vinyl polymers and polybutadiene

The thermal decomposition mechanism of vinyl polymers is well known<sup>2,3</sup>. The degradation starts with the homolytic scission of the polymer chain producing a primary and a secondary macroradical. Formation of a tertiary macroradical – due to the loss of a hydrogen from a tertiary carbon atom – may also initiate decomposition of the macromolecule shown in Scheme 1, where X= phenyl or nitrile group in the case of ABS copolymers. The further decomposition of the tertiary macroradical by  $\beta$ -scission leads also to a secondary macroradical and a vinyl ended macromolecular chain. The chemical reactions of the macroradicals are obviously influenced by the nature of the X substituents. Note, the stability of a secondary or a tertiary hydrocarbon radical with a phenyl substituent (benzylic radical) is higher than that with a nitrile one (cyanomethylene radical).

## Pyrolysis products of polystyrene

The pyrolysis products of polystyrene (PS) – a homopolymer build up of styrene monomers only – may be derived wholly from the thermal decomposition of the secondary macroradicals outlined in Scheme 2, where X= phenyl group. Depolymerisation is a radical chain reaction; moreover, both the dimer and trimer forming reactions are reproducing also a secondary macroradical.

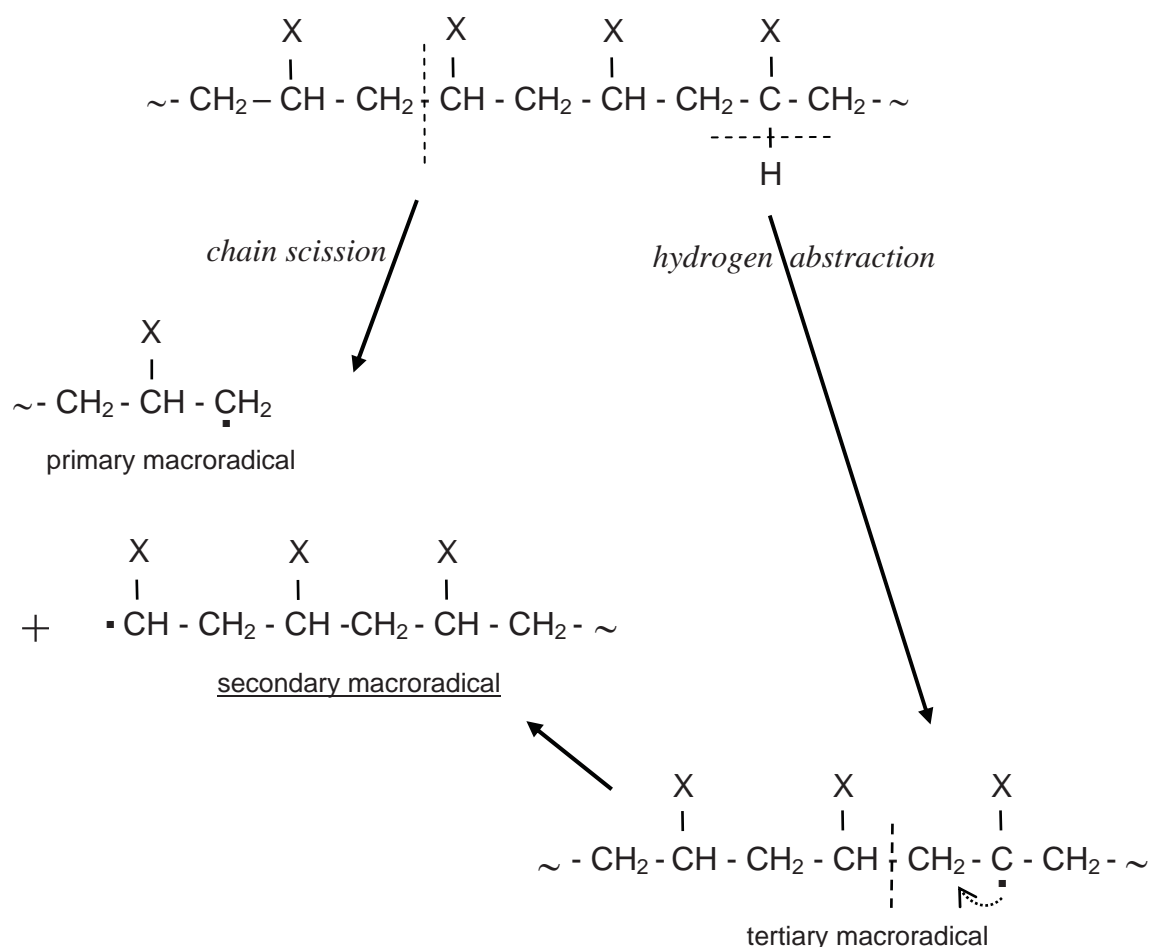

**Scheme 1. Initiation of the thermal decomposition in vinyl polymers**

#### Pyrolysis products of polyacrylonitrile

From polyacrylonitrile (PAN) monomer, dimer and trimer are also produced by fast pyrolysis; however, in this vinyl polymer the interaction of the adjacent nitrile substituents is also promoted thermally. Sequences of imine rings are formed, and the resultant ladder-like polymer chain is better carbonised than volatilised by heat<sup>4</sup>. However, this kind of structural change cannot take place in such a copolymer where the acrylonitrile units are separated by another type of monomer as in ABS.

#### Pyrolysis products of polybutadiene

The weakest C-C bond in the macromolecular chain of polybutadiene is that of allyl position to the double bond thus the initial step of thermal decomposition is an allyl cleavage resulting in two similarly terminated primary macroradicals. Depolymerisation of the macroradical leads to monomer, and vinylcyclohexene. The latter is the result of the cleavage of a dimeric segment through a backbiting reaction forming a cycle from the six terminal atoms of the macroradical. Both monomer and dimer cleavage reactions are reproducing the initial macroradical of polybutadiene.

#### Thermal decomposition of styrene copolymers

The thermal decomposition reactions of the styrene copolymers either with butadiene or with acrylonitrile should have similarities to those of ABS.

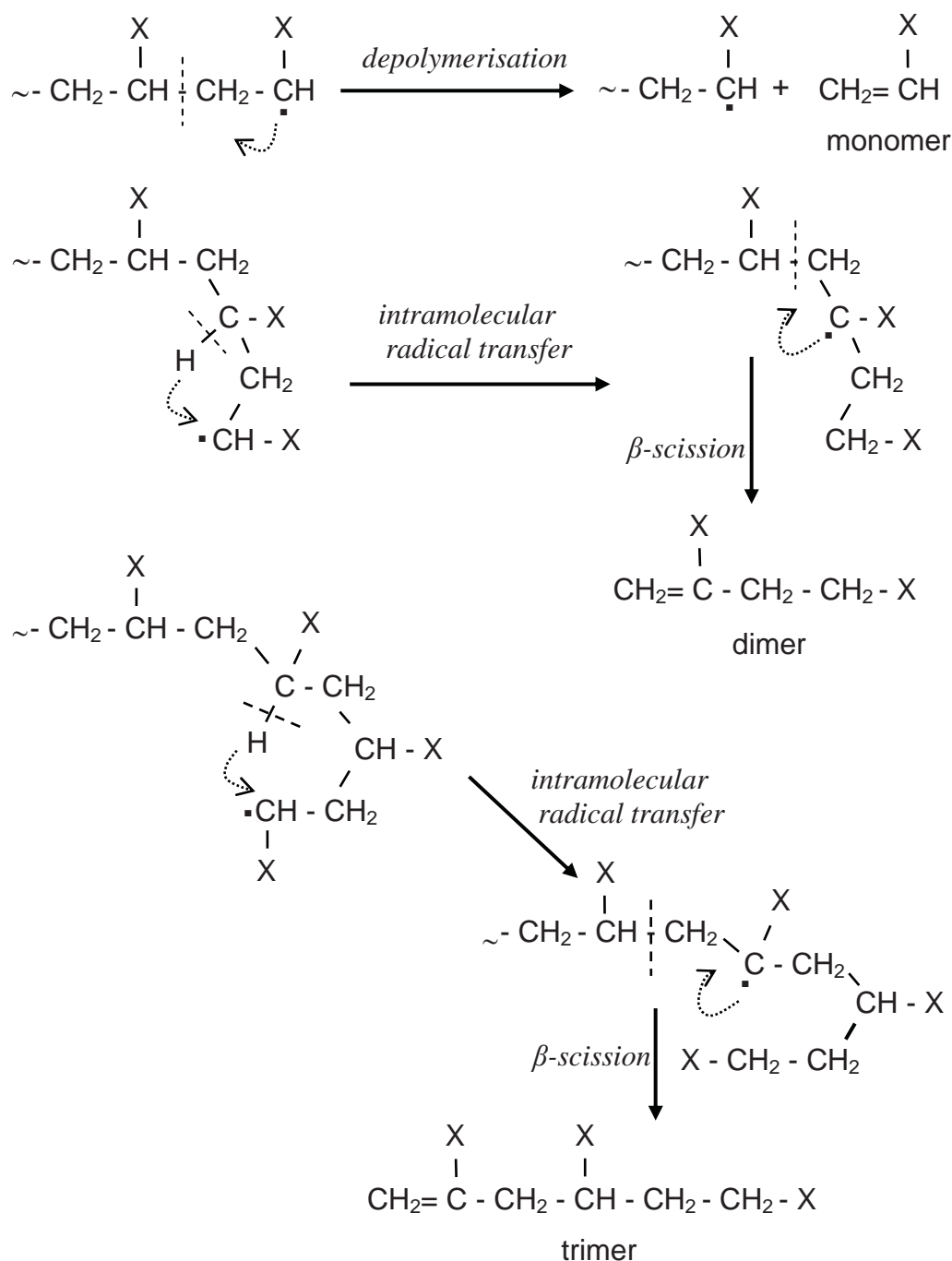

**Scheme 2. Thermal decomposition of secondary macroradical in polystyrene (X= phenyl)**

#### Pyrolysis products of high impact polystyrene

In high impact polystyrene (HIPS) butadiene is the co-monomer. Although the butadiene content of HIPS is usually low, typical differences are observed in the pyrolysis products compared to those of PS. The pyrolysis-gas chromatograms of HIPS and PS are shown in Figure 1. Toluene and  $\alpha$ -methylstyrene, which are generally minor components of PS pyrolysate at around 500 C, become significant among the products of HIPS. The new additional products are 1,3-diphenylpropane, and isomers of styrene dimer and trimer. The appearance of the latter compounds are certainly related to the presence of the butadiene co-

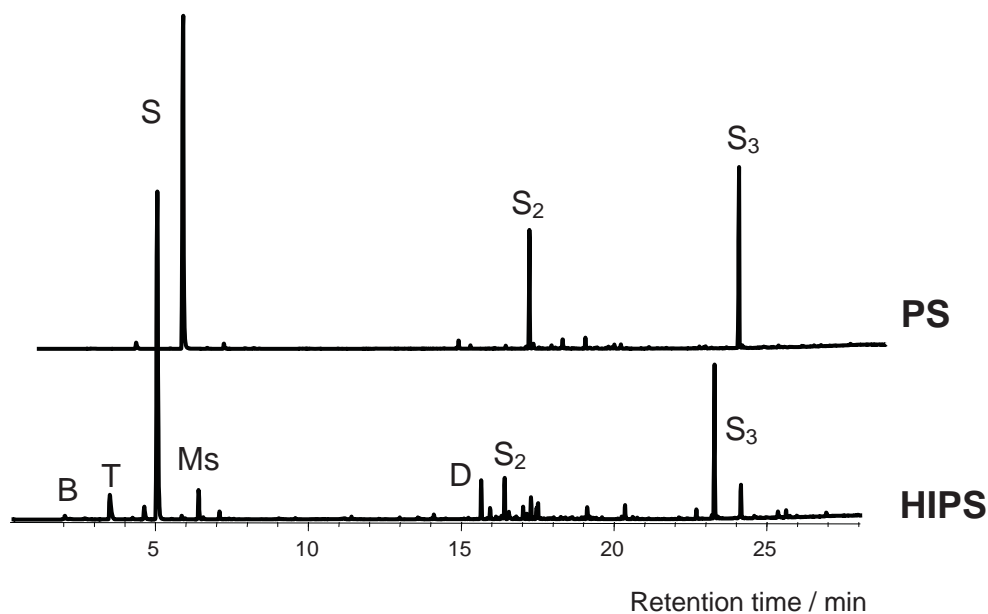
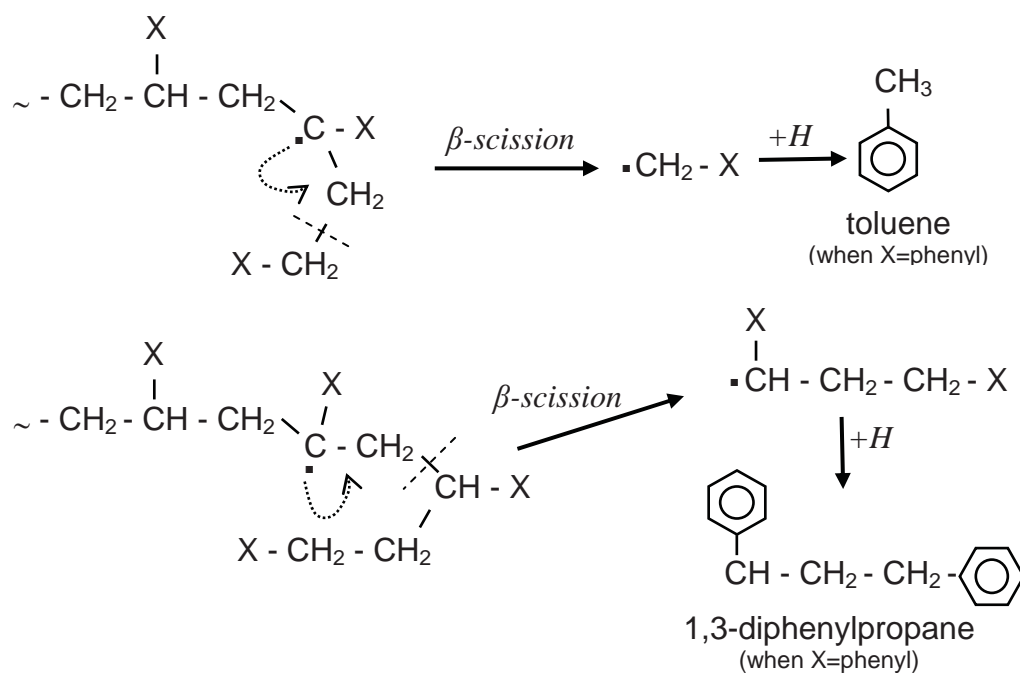
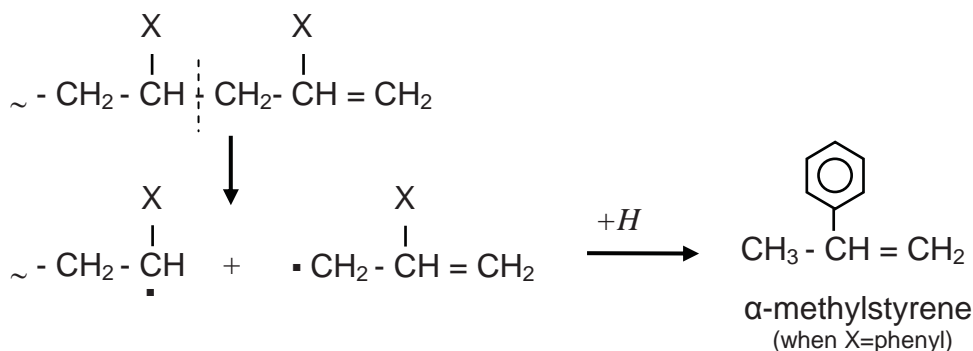

Figure 1. Pyrolysis products of PS and HIPS at 500°C. B, butadiene; T, toluene; S, styrene; Ms,  $\alpha$ -methylstyrene; D, 1,3-diphenylpropane; S<sub>2</sub>, styrene dimer; S<sub>3</sub>, styrene trimer.

monomeric units in the chain structure of PS. We may admit that butadiene sequences are able to serve as hydrogen source for stabilizing small radicals such as benzyl. In the reactions of dimer and trimer formation drawn in Scheme 2,  $\beta$ -scission in the other direction along the macroradicals leads to small radicals forming toluene and 1,3-diphenylpropane shown in Scheme 3. The production of  $\alpha$ -methylstyrene may be derived from the chain end cleavage of vinyl-terminated macromolecules formed by the decomposition of tertiary macroradicals by beta scission. The 2-phenyl-2-propenyl radical split off from polymer terminal sequence is stabilized by hydrogen to give  $\alpha$ -methylstyrene depicted in Scheme 4.



Scheme 3. Formation of small radicals by  $\beta$ -scission of tertiary macroradicals at chain terminals.



**Scheme 4.** Chain end cleavage of vinyl terminated macromolecules leading to small radicals.

Pyrolysis products of poly(styrene-*co*-acrylonitrile) (SAN)

The thermal decomposition of a copolymer build up of about equal molar ratios of styrene and acrylonitrile with random distribution of the co-monomers leads to a mixture of monomers, dimers and trimers at around 500°C<sup>5</sup>. In accordance with the random distribution of the monomers in the copolymer, those products, which contain only one kind of monomer, are relatively less important. The pyrolysis-gas chromatograms of SAN and ABS are shown in Figure 2.

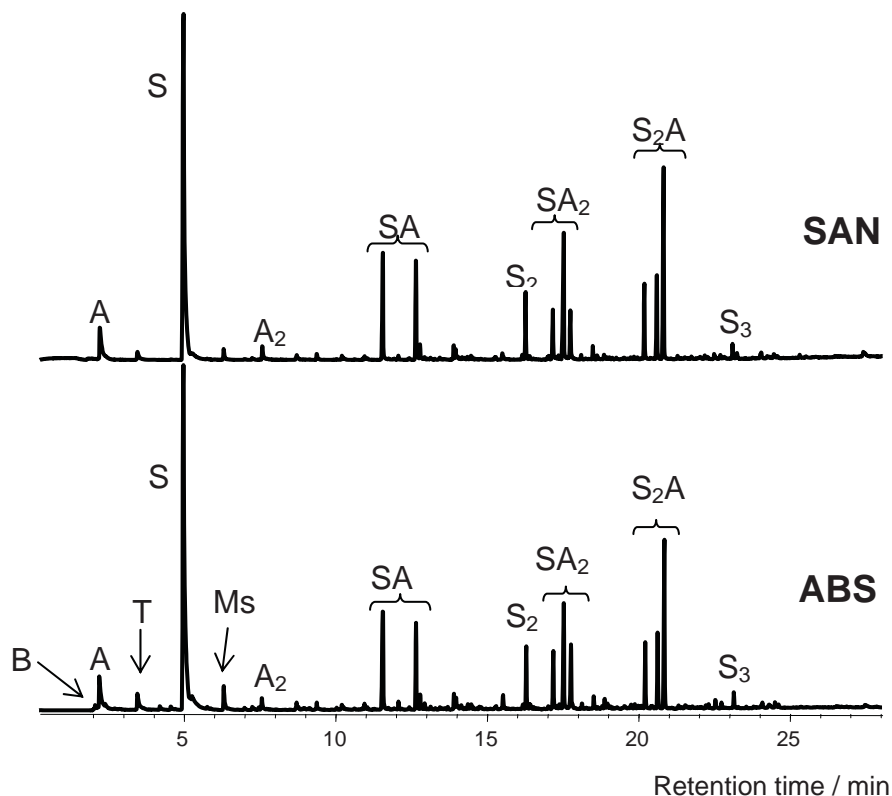

**Figure 2.** Pyrolysis products of SAN and ABS at 500°C. B, butadiene; A, acrylonitrile; T, toluene; S, styrene; Ms,  $\alpha$ -methylstyrene; A<sub>2</sub>, acrylonitrile dimer; SA, hybrid dimer isomers; S<sub>2</sub>, styrene dimer; SA<sub>2</sub> and S<sub>2</sub>A, hybrid trimer isomers; S<sub>3</sub>, styrene trimer.

The general thermal decomposition mechanism of vinyl polymers depicted in Scheme 1 has been proved to be valid also for copolymers already more than twenty years ago<sup>5,6</sup>, and all the possible isomers of hybrid dimers, trimers of various monomers (among them those of styrene and acrylonitrile) have been identified by GC/MS.



### Pyrolysis products of ABS

In the knowledge of the minor differences in the composition of the pyrolysate of PS and HIPS, it is not surprising that the pyrograms of SAN and ABS are very much alike when the ratio of styrene and acrylonitrile is similar in the compared copolymers. The minor deviation observed in the higher relative amounts of toluene and  $\alpha$ -methylstyrene should be attributed to the butadiene component of the ABS copolymer. Nevertheless, it is notable that the amount of butadiene and vinylcyclohexene (dimer of butadiene) related to styrene is not much more in the pyrolysate of the investigated ABS than in that of HIPS, although the polybutadiene content in ABS is at least the triple of that in HIPS. Low contribution of the polybutadiene component to the volatile products was reported studying various ABS samples in different pyrolysers<sup>7,8</sup>.

The hybrid dimers and trimers of ABS all contain nitrile groups, thus their robust contribution to the pyrolysis oil does not give preference to the pyrolytic recycling of wastes containing ABS. Although the importance of trimers is decreasing with increasing pyrolysis temperature, obviously we have to find other ways to suppress the formation of the dimers and trimers.

### Effects of coprolysing ABS with possible waste components

When ABS is coprolysed with PVC the monomer formation is promoted over that of oligomers<sup>7</sup>. The relative amounts of toluene, ethylbenzene,  $\alpha$ -methylstyrene and 1,3-diphenylpropane and 1-cyano-3-phenylpropane are also raised. Similar effect is observable when ABS is coprolysed with carbon black demonstrated in Figure 3. The carbonaceous

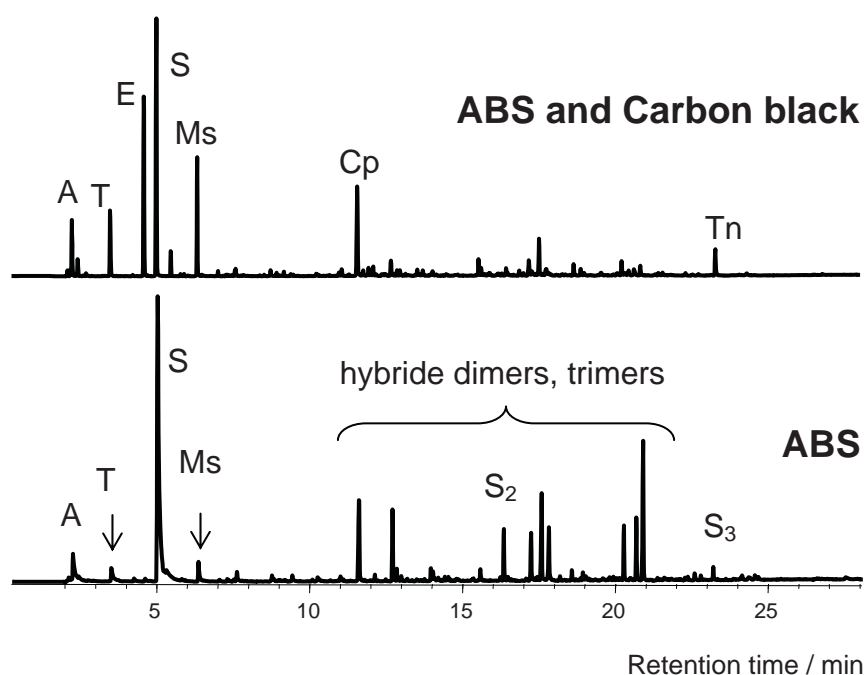

Figure 3. Pyrolysis products of ABS and ABS + Carbon black at 500°C. A, acrylonitrile; T, toluene; E, ethylbenzene; S, styrene; Ms,  $\alpha$ -methylstyrene; Cp, 1-cyano-3-phenylpropane; S<sub>2</sub>, styrene dimer; S<sub>3</sub>, styrene trimer, Tn, cyanoterphenyl.

component seemingly strongly promotes the hydrogenation of small radicals; even a part of styrene is also hydrogenated. However, the formation of cyanoterphenyl indicates that simultaneously the partial aromatisation of the monomeric triads also takes place.

## Effects of catalysts on the thermal decomposition of ABS

Silica alumina combination with iron oxide has been proposed for thermal catalytic degradation of ABS for avoiding of heavy aliphatic nitriles in the product oil obtained in a semi-batch reactor<sup>8</sup>. In our laboratory ABS have been pyrolysed together with molecular sieve 13X in an analytical pyrolyser coupled to GC/MS, and also observed that the oligomeric components of the pyrolysate are considerably losing their importance, while the yield of monomers and hydrogenated small radicals increased. The pyrograms demonstrating the change of product distribution are shown in Figure 4. When ABS and molecular sieve 13X of similar amounts are copyrolysed, the summed peak area of monomeric range of the pyrogram increases to 70 %. Although 30 area % of the oligomeric peaks still corresponds a rather high nitrile content in the pyrolysis oil, the ability of this molecular sieve to escape nitriles is clear.

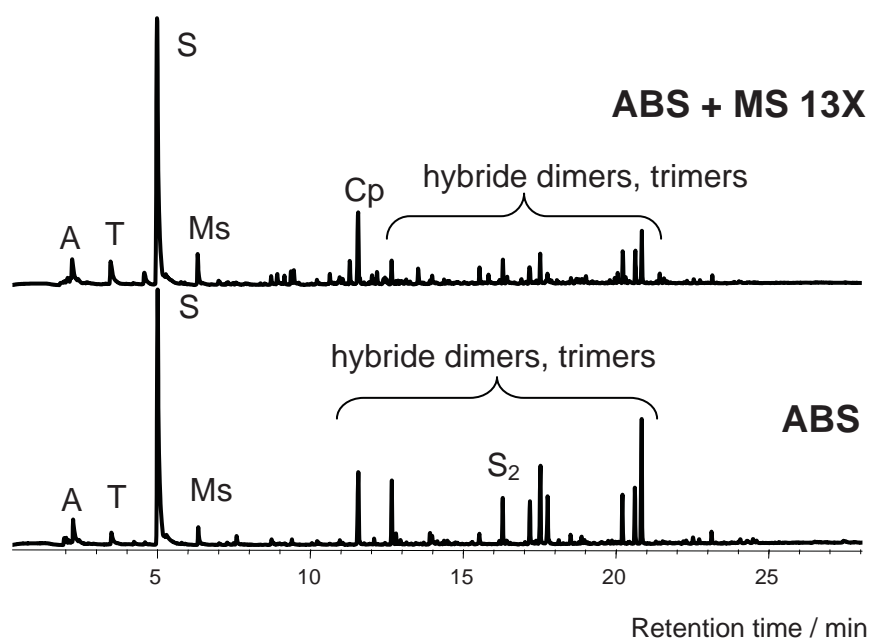

Figure 4. Pyrolysis products of ABS and ABS + Molecular sieve 13X at 500°C. A, acrylonitrile; T, toluene; S, styrene; Ms,  $\alpha$ -methylstyrene; Cp, 1-cyano-3-phenylpropane; S<sub>2</sub>, styrene dimer.

## Acknowledgement

This work was supported by the Hungarian National Research Fund (OTKA contact No.T033111) and by the European Community (project No. G1RD-CT-2002-03014).

## References

- <sup>1</sup> Modern Plastics Encyclopedia, Vol. 59, McGraw-Hill, Inc., New York, 1982, p. 466.
- <sup>2</sup> Y. Tsuchiya, K. Sumi, *J Appl. Polym. Sci.* 21 (1977). 21.
- <sup>3</sup> L. Reich, S.S. Stivala, Elements of Polymer Degradation, McGraw Hill, New York, 1971.
- <sup>4</sup> F. A. Bell, R. S. Lehrle, J. C. Robb, *Polymer* 1971, 12, 579.
- <sup>5</sup> M. Blazsó, G. Várhegyi, E. Jakab, *J. Anal. Appl. Pyrolysis* 2 (1980) 177.
- <sup>6</sup> T. Nagaya, Y. Sugimura, S. Tsuge, *Macromolecules* 13 (1980) 928.
- <sup>7</sup> M. Day, J.D. Cooney, C. Touchette-Barrette, S.E. Sheehan, *J. Anal. Appl. Pyrolysis* 52 (1999) 199–224
- <sup>8</sup> M. Brebu, M.A. Uddin, A. Muto, Y. Sakata, C. Vasile *J. Anal. Appl. Pyrolysis* 63 (2002) 43.

# Fast Pyrolysis for Waste Wood Treatment

D. Meier

Federal Research Centre for Forestry and Forest Products,  
Institute for Wood Chemistry and Chemical Technology of Wood, Hamburg, Germany

## Introduction

On 1 March 2003 the German Ordinance on the Management of Waste Wood entered into force. The Ordinance laid down specific requirements for the recycling and energy recovery as well as for the disposal of waste wood on the basis of the Closed Substance Cycle and Waste Management Act.

The Ordinance covers all the common methods of waste wood management such as preparing waste wood for the production of derived timber products, the production of active carbon or industrial charcoal and synthesis gas and the energy recovery of waste wood as a substitute fuel. If waste wood cannot be recovered, it must be disposed of using thermal processes. Landfilling is not permitted. Other possible recovery paths are not regulated by the Ordinance but are also not excluded so that the incorporation of new recovery paths and innovative recovery procedures for waste wood are not restricted. Whether these are permissible according to waste law will then be assessed not on the basis of the Waste Wood Ordinance but directly on the basis of the requirements in the Closed Substance Cycle and Waste Management Act.

The requirements in the Waste Wood Ordinance define high-quality substance recycling and energy recovery procedures. There is no regulation in the Ordinance on priority for substance recycling or energy recovery. The waste holder thus has the choice between substance recycling and energy recovery.

Waste wood must be assigned to one of four waste wood categories depending on the level of pollution, from A I (waste wood in its natural state or only mechanically worked) to A IV (waste wood treated with wood preservatives, e.g. railway sleepers, hop poles, etc.). To simplify assignment, the Ordinance contains a general rule to be applied for the common types of waste wood: In the case of a mixture of different waste wood categories, the mixture must always be assigned to the category subjected to the most stringent provisions.

In order to ensure safe recovery, the waste wood categories A I to A IV are then allocated to the individual substance recycling paths; energy recovery is governed by the provisions of the Federal Immission Control Act and the statutory ordinances issued on the basis thereof. Waste wood containing PCBs is classified as a “special category” if its PCB content is more than 50 mg/kg. Waste wood containing PCBs must be disposed of in accordance with the PCB/PCT Waste Ordinance – only thermal treatment procedures come into question.

The waste wood categories A I to A IV may be used for the manufacture of active carbon/industrial charcoal and the production of synthetic gas as well as in incineration and gasification plants that are licensed pursuant to the Fourth Ordinance on the Implementation of the Federal Immission Control Act and with regard to emissions are subject to the Seventeenth Ordinance on the Implementation of the Federal Immission Control Act. During these procedures, the organic pollutants contained in the waste wood are completely destroyed

due to the high temperatures. Heavy metals are bound as solid in the residues or dispersed during waste gas purification.

Because of the new legislations there is an increasing applications for waste wood combustion plants for the production of heat and power. Therefore, prices are rising and are difficult to predict. Latest price information are given in Table 1.

Table 1 Average prices in Germany free at gate for combustion plant (€/t) (1)

		April 1999	May 2000	April 2001	February 2002
A I (untreated)	unshredded	0 to 25	8 to 13	8 to 28	15 to 28
A II/A III (treated)	chopped	-18 to 0	-15 to 0	-15 to 5	15 to 28 (A II) -15 to 10 (A III)
A IV (contaminated)	not chopped	-128 to -51	-72 to -31	-66 to -26	-30 to 5

Table 2 shows the materials flow of German waste wood. Most of the input material comes from demolition and furniture. About one third is currently dumped on landfills and more than a quarter is exported. This situation is changing now as landfill will be banned by the new ordinance.

Table 2 Materials flow of German waste wood (2)

INPUT (%)		OUTPUT (%)	
demolition	41	landfill	31
furniture	35	export (to Sweden for energy, to Italy for particle boards)	27
packaging	12	incineration & combustion	22
sleepers & poles	12	particle boards	20

In a recent interim report about the monitoring of the biomass ordinance (1), the authors report for instance on desiderative innovative concepts such as gasification and small utilization of heat combined with low efficiencies of power production. Apart from gasification of waste wood, fast pyrolysis for liquid production is an option of converting waste wood into a storable liquid which can be used both as liquid fuel in boilers and stationary diesel engines for heat and power production or as source for chemical feedstocks. This paper describes results from the fast pyrolysis of different waste wood assortments with inorganic and organic contaminants.

## Experimental

### MATERIALS AND IMPREGNATION

Beech wood (*Fagus sylvatica L.*) particles of 1.5-3 mm with a water content of 10 % were generally used for the experiments. Impregnation was performed by firstly soaking biomass with the dissolved compounds and secondly applying vacuum for penetration of the compounds into the wood matrix.

For impregnation with metal-organic complexes, 10 g from each compound (see Table 3) were used to impregnate 3 kg of wood.

Table 3 Metal-organic complexes used for wood impregnation

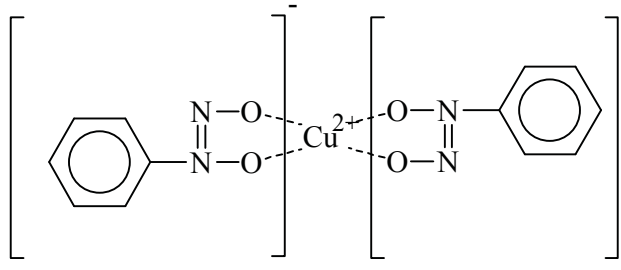
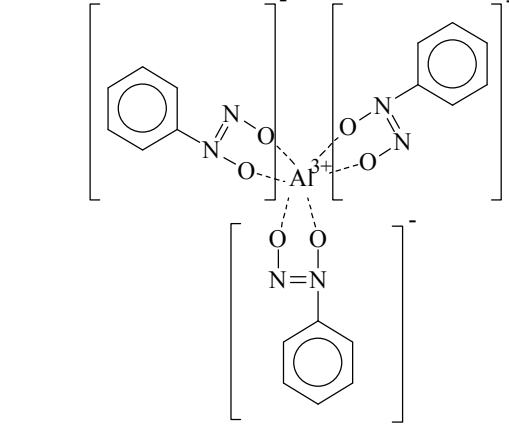
copper HDO	 <p>The diagram shows a central copper ion (Cu<sup>2+</sup>) coordinated to four oxygen atoms of two hydrazine derivatives. Each hydrazine derivative consists of a benzene ring attached to a nitrogen atom, which is double-bonded to another nitrogen atom. This second nitrogen atom is bonded to two oxygen atoms. Dashed lines represent the coordination bonds between the Cu<sup>2+</sup> ion and the four oxygen atoms. The entire complex is enclosed in large square brackets with a negative charge symbol (-) at the top right.</p>
aluminum-HDO	 <p>The diagram shows a central aluminum ion (Al<sup>3+</sup>) coordinated to six oxygen atoms of three hydrazine derivatives. Each hydrazine derivative consists of a benzene ring attached to a nitrogen atom, which is double-bonded to another nitrogen atom. This second nitrogen atom is bonded to two oxygen atoms. Dashed lines represent the coordination bonds between the Al<sup>3+</sup> ion and the six oxygen atoms. The entire complex is enclosed in large square brackets with a negative charge symbol (-) at the top right.</p>

For organic contaminants, 3 kilograms of biomass were impregnated with 3 g of the corresponding single organic compound. The list of tested contaminants appears in Table 4.

Table 4 List of organic compounds used for wood impregnation

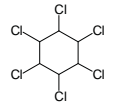
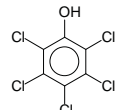
No.	Chemical Name	Chemical Formula
1	Hexachloro-cyclohexane (lindane)	 <p>The diagram shows a cyclohexane ring with a chlorine atom (Cl) attached to each of the six carbon atoms.</p>
2	Pentachlorophenol (PCP)	 <p>The diagram shows a benzene ring with a hydroxyl group (OH) attached to one carbon atom and a chlorine atom (Cl) attached to each of the other five carbon atoms.</p>

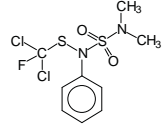
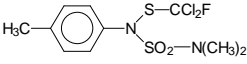
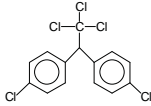
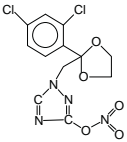
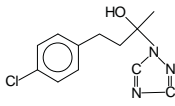
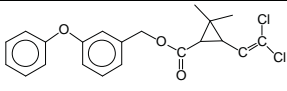
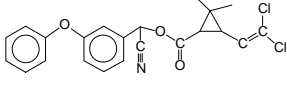
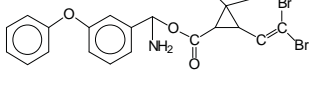
3	Dichlofluanide (DCFN)	
4	Toluyfluanide (TFN)	
5	(1,1,1-Trichloro-2,2-bis-(p-chlorophenyl)-ethane (DDT)	
6	Propioconazole	
7	Tebuconazole	
8	Permethrine	
9	Cypermethrine	
10	Deltamethrine	

Biomass was also impregnated with an inorganic salt solution (CCB, 20 % concentration) consisting of 38 %  $K_2Cr_2O_7 \cdot 2H_2O$ , 34%  $CuSO_4 \cdot 5H_2O$ , 25 %  $HBO_3$  and 3 %  $NaHSO_4$ . From this solution 300 ml were used to impregnate 3 kg of wood.

Furthermore, representative samples from a waste wood collection site (Otto Dörner, Hamburg) were subjected to fast pyrolysis and analysis. Three contamination classes, A II, A II and A IV were selected. A II contained particle boards and window frames, A III consisted of fences and cable drums, and A IV comprised railway sleepers.

#### ANALYTICAL METHODS

Organic contaminants were analyzed by gas chromatography using a CHROMPACK CP 9000 and a DB-1 column (30 m x 0.25 mm, 0.32  $\mu m$  film thickness) with the following temperature programme: initial: 120 °C, heating rate: 5 °C, final 320 °C, hold for 10 minutes. For calibration solutions with two concentration levels (10 and 100  $\mu g/ml$ ), following DIN 38402, were used. Fluoroanthene was used as internal standard.

In order to reduce matrix effects from the bio oil, solid phase extraction (SPE) was applied, using 500 mg silica cartridges. They were conditioned with 2 ml of ethyl acetate. Then 200  $\mu g$  of whole bio oil was placed on top of the silica and all the relevant toxic compounds eluted

with 2 ml of ethyl acetate. To this solution the internal standard was added and the mixture subjected to GC.

### Metals

Metals were analyzed using dispersive X-ray fluorescence spectroscopy (XRF) on a SPECTRACE 6000. 2 g of sample were used. For metals in char multi-level calibrations within a range of 10-20,000 ppm were carried out. For the liquid samples the range was set between 1 and 10,000 ppm.

### Dioxins (PCDD/PCDF)

Analysis of PCDD/PCDF was carried out at a certified laboratory (ERGO, Hamburg) using high resolution GC/MS methods. Identification and quantification with a dissolution method was performed following VDI procedure 3499. Samples of bio oil and gas prior to combustion were sent to the laboratory. Gaseous contaminants were collected on a special polyurethane cartridge.

### FAST PYROLYSIS

Fast pyrolysis of waste wood has been performed in a pilot plant equipped with a fluidized bed reactor with a nominal capacity of 5 kg/h. A schematic diagram is presented in Fig. 1.

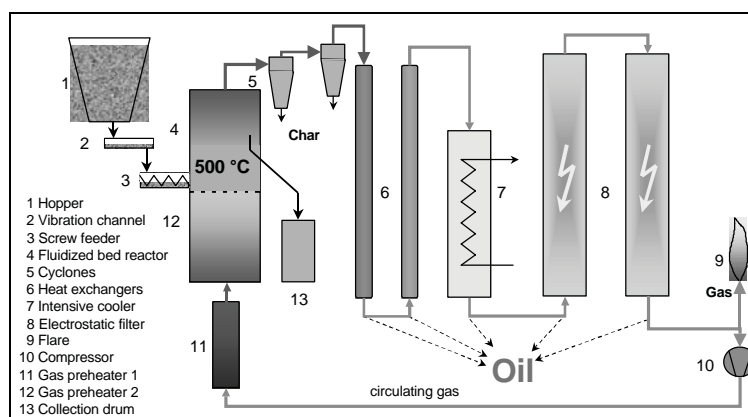

Fig. 1 Schematic diagram of pilot plant for fast pyrolysis of waste wood

Wood feeding was from the hopper via a vibration channel to a water-cooled screw feeder running at constant velocity. Throughput was controlled by the vibration frequency. Wood particles entered the reactor just above the distribution plate of the fluidized bed reactor. An escape pipe inside the reactor was used to remove larger charcoal particles. Vapors and smaller char particles were entrained with the fluidizing gas. Two cyclones separated the fine char particles and the residual vapors were condensed in a condensation train consisting of two tubular water-cooled heat exchangers (operated at 200 and 80° °C, respectively), an intensive cooler operated at -15 °C, and two electrostatic precipitators working at approximately -15 kV. The non condensable gases were circulated as fluidizing gas. Surplus gas was burnt in a flare.

### Results and Discussion

No significant differences in the yield of the main products liquid, gas, and char from untreated and treated wood were observed (see Fig. 2).

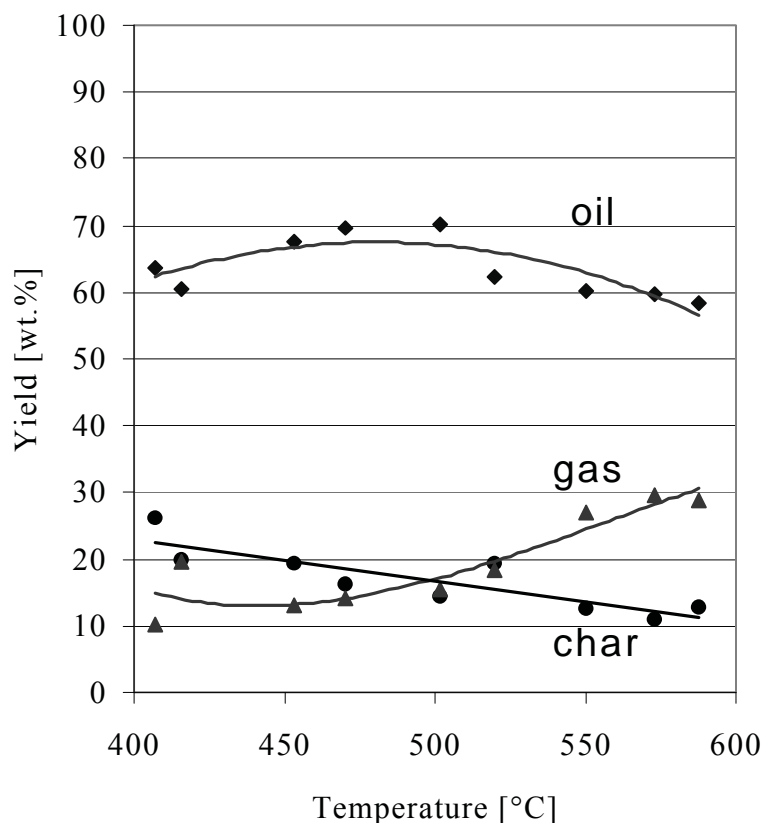

Fig. 2 Typical yields of fast pyrolysis experiments with the pilot plant

Oil yields reached almost 70 % at 475 °C reactor temperature. With increasing temperature the gas yields increase and the char yields decrease correspondingly.

CCB impregnated wood was pyrolyzed at 500 and 600 °C and the heavy metals copper and chromium were determined in the char and liquid by XRF (see Table 5). The data clearly show that typical heavy metals from wood preservatives are trapped together with the char fraction. If the char is burnt for energy recovery, the heavy metals would remain in the ash. From here they might be recovered or dumped. The oil is practically uncontaminated. These results are consistent with those found already in a laboratory fluidized bed reactor (3).

Table 5 XRF analysis of Cu and Cr in pyrolysis oil and char

contaminant	500 °C CCB alone		600 °C CCB with organic preservative	
	char	oil	char	oil
copper (ppm)	22560	12	8257	16
chromium (ppm)	31561	4	19768	3



XRF analysis was also performed on pyrolysis oil and char from fast pyrolysis of real wood waste obtained from a commercial collection and separation site. The XRF data show similar results compared to the samples impregnated in the laboratory. Various mono-fractions from the collection site were pyrolyzed such as cable drums, fences, railway sleepers, particle boards and window frames. The results are presented in Table 6 and are based on the whole oil whereas the data presented in (4) only refer to the cleaning oil fraction. Nothing could be detected in the oils collected from the condensation train.

Table 6 XRF analysis (in ppm) of Cu and Cr from authentic waste wood samples

	cable drums		fences		railway sleepers		particle boards		window frames	
	char	oil	char	oil	char	oil	char	oil	char	oil
Cu	6921	0.42	1628	0.48	932	0,49	270	1.64	681	0.74
Cr	14103	1.12	4748	0.14	267	0.11	527	0.36	465	0.21

The metal-organic preservatives copper HDO and aluminum HDO are commonly used for timber used in landscaping. Therefore, samples impregnated with these preservatives were also pyrolyzed at 500 °C. Aluminum could not be measured in the oil because the chamber had to be evacuated resulting in contamination of the inner walls with pyrolysis liquids. Therefore, only the char was analyzed for Al resulting in a recovery of 82.7 %. Hence, 17.3 % of the input aluminum is expected to remain in the oil. This is much more compared to Cu and Cr due to the lower melting and boiling point of Al.

In the past, various chloro-organic compounds were used in preservative formulations in Germany. They are highly toxic not only towards bacteria, fungi and insects but also for humans. Therefore, it was of special interest to study their fate with fast pyrolysis. Each beech wood sample was impregnated with one compound mentioned in Table 4. In order to obtain measurable amounts after pyrolysis it was decided to use a high concentration of 1 g/kg which was thought to represent the worst case. In practice this concentration is unrealistic as no discrimination between the different organic preservatives can be made at the wood collection site.

Table 7 Recovery rate (%) of chloro-organic compounds based on initial concentration

	Temperature °C			
	450	500	550	580
Lindane	33.06	29.84	16.33	2.02
PCP	42.18	25.13	25.03	13.04
DCFN	10.65	7.45	3.13	2.40
Toluylfluamide	18.72	17.00	13.10	7.92
Propioconazole	40.47	26.92	23.80	16.66
DDT	0	0	0	0
Tebuconazole	40.16	28.11	26.19	15.93
Permethrine	32.51	22.76	13.51	6.83
Cypermethrine	4.26	0.68	0.47	0.32
Deltamethrine	3.00	2.10	1.61	0

Pyrolysis experiments were conducted at different temperatures: 450, 500, 550, and 580 °C. Quantitative analyses of each compound were performed by GC using the internal standard method. A special clean-up procedure with silica cartridges was used to enrich the compounds in the sample solution and to reduce matrix effects from the pyrolysis liquid.

Generally speaking, the concentrations of the contaminants decrease with higher pyrolysis temperatures. PCP, HCH, propiconazole, tebuconazole, and permethrine are destroyed by 60-70 % already at the lowest pyrolysis temperature of 450 °C. At 580 °C the reduction reaches 80-95 % based on the initial concentration (see Fig. 3).

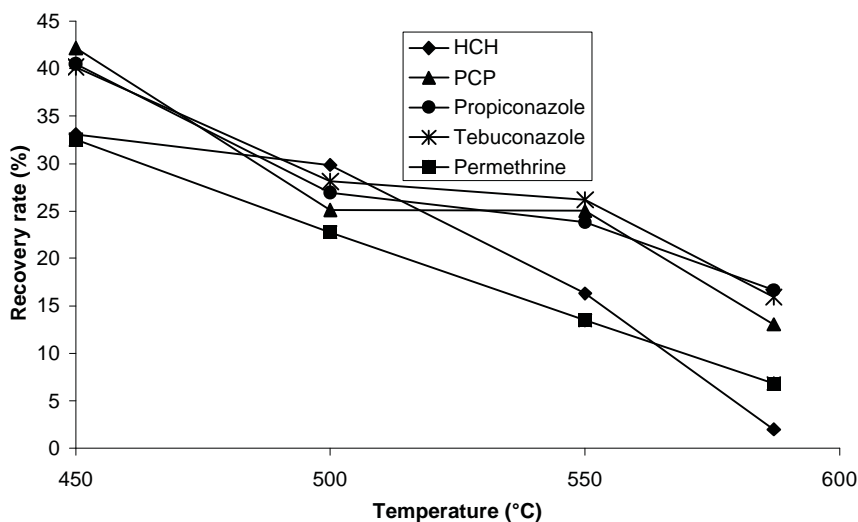

Fig. 3 Decrease of recovery rate with increasing temperature of selected chloro-organic compounds

The pyrethroids deltamethrine and cypermethrine as well as toluylfluanide and dichlofluanide are even further destroyed. At 450 °C they lost 80-98 % of their initial concentration and at 580 °C destruction rate is between 90 and 99 % (see Fig. 4). DDT is already completely destroyed at 450 °C.

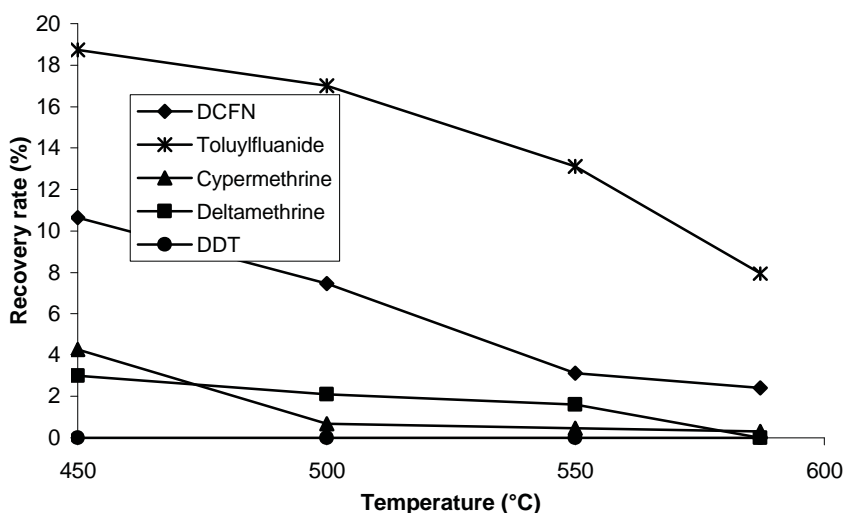

Fig. 4 Decrease of recovery rate with increasing temperature of selected chloro-organic compounds

In general, the presence of chloro-organic preservatives in thermal processing makes the formation of polychlorinated dibenzodioxins and polychlorinated dibenzofurans (PCDD/F)

Table 8 Concentration of PCDD/F in feedstock sample and pyrolysis products

	reference		spiked sample		
	bio oil (ppb)	preservative (ppb)	bio oil (ppb)	char (ppb)	gas ng/m <sup>3</sup>
<b>PCDD</b>					
Tetra	n.d.	n.d.	51.0	0.45	0.0043
Penta	n.d.	n.d.	272.4	1.50	0.0237
Hexa-1	n.d.	n.d.	166.6	0.80	0.0212
Hexa-2	0.0195	55	375.6	2.23	0.0363
Hexa-3	n.d.	5	285.3	2.63	0.0257
Hepta	1.896	4194	2163.0	26.83	0.1870
Octa	32.12	47007	4719.8	76.24	0.3190
<b>total PCDD</b>	<b>34.04</b>	<b>51261</b>	<b>8033.7</b>	<b>110.68</b>	<b>0.6173</b>
<b>PCDF</b>					
Tetra	0.0019	n.d.	3.3	0.04	0.0004
Penta-1	n.d.	n.d.	6.1	0.06	0.0005
Penta-2	0.0013	n.d.	4.8	0.04	0.0003
Hexa-1	0.0111	29	14.9	0.12	0.0012
Hexa-2	0.0035	n.d.	16.5	0.16	0.0010
Hexa-3	n.d.	n.d.	1.30	0.02	0.0002
Hexa-4	n.d.	n.d.	4.40	0.05	0.0003
Hepta-1	0.2748	709	33.2	0.32	0.0026
Hepta-2	0.0288	158	11.5	0.08	0.0017
Octa	6.1900	11598	99.6	0.91	0.0010
<b>total PCDF</b>	<b>6.51</b>	<b>12494</b>	<b>195.6</b>	<b>1.8</b>	<b>0.01</b>
<b>total PCDD/PCDF</b>	<b>40</b>	<b>63755</b>	<b>8229</b>	<b>112</b>	<b>0.63</b>
<b>I-TE</b>	<b>0.064</b>	<b>118</b>	<b>303</b>	<b>2</b>	<b>27</b>

n.d. = not detected

highly probable. Their formation rate is highest at around 300 °C (5). In contrast to polyaromatic hydrocarbons (PAH), PCDD/F are formed especially at temperatures below 600 °C (deNovo synthesis). A prerequisite for reaction is the presence of char particulates, chlorine particulates and gaseous oxygen (6).

As fast pyrolysis occurs in an inert atmosphere the formation of PCDD/F might be reduced. To test this thesis, two experiments were carried out: one blank run with beech wood and another with beech wood spiked with CCB salt and technical grade PCP containing high concentrations of substituted hepta- and octa-PCDD/F (see Table 8). The highly substituted compounds are degraded in favor of less substituted, but more toxic compounds. Therefore, the toxicity of product bio-oil increased by a factor of 2.57 as demonstrated by the increase of the International Toxicity Equivalent (I-TE).

However, it is not clear whether a de novo synthesis took place or just recombination reactions. From the total PCDD/F content the oil contains 98.65 %, the char has 1.34 and the

gas has only 0.01 %. If the oil is used as fuel one has to carefully select the combustion conditions in order to destroy the PCDD/F completely.

The results presented here show the general trend if chloro-organic compounds are present in the feedstock. The amount of chloro-organics in the feedstock used here were somewhat unrealistic but selected to better understand and measure PCDD/F formation and concentration in the products of fast pyrolysis. In reality, there are no mono-fractions of wood contaminated only with chloro-organic compounds. Generally, pyrolysis of waste wood mixtures results in a much less contaminated oil as presented in this study. However, further investigations are necessary to prove if de novo synthesis takes place during fast pyrolysis of contaminated waste wood.

## Conclusions

The results of this study show that fast pyrolysis of contaminated waste wood is technically feasible without any restrictions. Heavy metal compounds introduced by wood preservatives are almost completely mechanically separated by cyclones together with the charcoal.

The destruction rate of chlorinated organic compounds depends on the temperature, the higher it is the higher the extent of degradation. At 580 °C the recovery was between 0 and 16.7 %. Polychlorinated dioxins or furans present in preservatives are partly destroyed. However, more toxic compounds with a lower degree of chlorine substitution are formed. Thus, high temperature combustion of these liquids is necessary to meet the German limit of 0.1 ng/m<sup>3</sup>. It should be noted that for the sake of analysis worst case samples were pyrolyzed in order to get measurable amounts of substances. In reality much less contamination is expected. No organic preservatives (except from railway sleepers) could be detected in the oil from fast pyrolysis of realistic waste wood mixtures.

## Acknowledgements

The financial support of Deutsche Bundesstiftung Umwelt, Osnabrück, project no. 03 631 is gratefully acknowledged.

## References

- 1 Institute for Energy and Environment, Leipzig. Report Biomassekatalog Sachsen-Anhalt, Summary of Final Report, 25-09-2002, p. 14.
- 2 Speckels L., BFH, Institute for Wood Physics, personal communication (2000).
- 3 Wehlte S., Meier D., & Faix O. (1997) The impact of wood preservatives on the flash pyrolysis of biomass. In: *Developments in Thermochemical Biomass Conversion*, (Ed by A.V. Bridgwater & D.G.B. Boocock), pp.206-219. Blackie Academic & Professional, London.
- 4 Bridgwater AV, Meier D, Radlein D. (1999) An overview of fast pyrolysis of biomass. *Org. Chem.*, **30**, 1479-1493.
- 5 Kolenda J., Gass H., Wilken M., Jäger J., Zeschmar-Lahl B.(1994) Determination and reduction of PCDD/PCDF emissions from wood burning facilities, *Chemosphere* **29**, 1927 –1938.
- 6 Mohr K, Wilken M, Nonn Ch, Jäger J. (1995) Behavior of PCDD under pyrolysis conditions, *Organohalogen Compounds*, **23**, 293-297.

# GASIFICATION OF BIOMASS - AGRICULTURAL RESIDUES TO SYNFUEL AND POWER -

E. Henrich, K. Raffelt, R. Stahl, F. Weirich,  
Forschungszentrum Karlsruhe, ITC-CPV, POB 3640, D 76021 Karlsruhe, Germany

## Abstract

A new two-step process for efficient and economic co-production of synfuel and electricity from the abundant ligno-cellulosic biomass is being developed at the research centre Karlsruhe. Biomass is first liquefied to pyrolysis oil by fast pyrolysis in many local facilities. The brittle pyrolysis char is pulverised and suspended in the pyrolysis oil. The oil/char-slurries can be easily stored in tanks and are transported, e.g. by rail, to a large-scale central plant for more economic syngas generation and use. An oxygen-blown entrained flow pressure gasifier is especially suited for final synfuel or chemicals production. The hot, pressurised syngas is tarfree, thus obviating expensive efforts for tar removal and syngas compression. The technical concept can be considered as the backbone of a large biomass refinery.

Feedstocks are not restricted to biomass. Flexibility and economy especially for large plants improve considerably, if the gasifier can be qualified for many different feedstocks. Any slurries or liquors prepared from fossil fuel or organic waste with sufficient LHV > ca. 10 MJ/kg are also suited, if they can be pumped and atomised. Also fluidised char or coal powders can be transferred into the gasifier by recycle of pressurised syngas.

## TRANSPORT FUEL FROM OIL

Transport for persons and goods is the indispensable basis of our global economy. Car, truck, ship and aircraft transport depend almost exclusively on liquid fuels from crude oil. As shown in fig. 1 [www.wec], about half of our crude oil supply is converted into transport fuels in large refineries. From 3.6 Gt crude oil in 2000, 0.84 Gt of gasoline, 0.7 Gt diesel and 0.22 Gt of aviation fuel have been produced; only 0.1-Gt of transport fuels are supplied from other sources, mainly from natural gas.

Road transport is the major transport fuel consumer. The number of about 500 million cars and 200 million trucks and buses is still rapidly increasing as shown in fig. 2 [Fis 2003], faster than motor efficiency. The demand for motor fuel is increasing correspondingly, not only in the developing countries but also still in industrialised countries like the EU, where about every second person owns a car. Transport fuel consumption is expected to rise towards 3 Gt/a within the next 2 – 3 decades. With business as usual, the higher

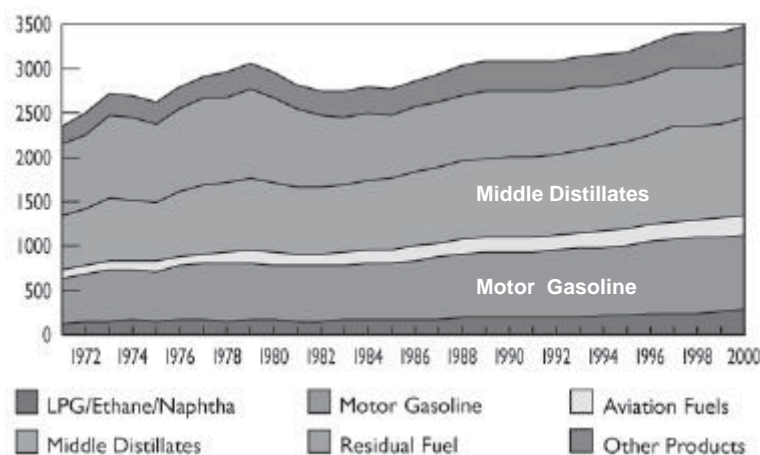

Fig. 1: Evolution of world refinery production by product in Mt.

consumption will be covered mainly by higher crude oil production. The proven and economically recoverable reserves of about 140 Gt of conventional oil plus the somewhat lower unconventional resources of oil sand will then be exhausted in the course of the century (see fig. 3).

### SYNTHETIC FUEL

It is inevitable on the long term, either to substitute transport fuels or to develop new alternative transport systems in due time. Production of gasoline, diesel or similar hydrocarbon fuels from other carbon resources like coal, natural gas or biomass and organic wastes is mostly based on known technology and the products are compatible with the available technical infrastructure without expensive modifications. This is a cheaper and faster approach to mitigate our oil dependence, than the market introduction of new fuels like hydrogen or even new traction system.

**Synfuel from coal:** Production of synthetic transport fuel from coal or natural gas via syngas is being practised in large technical facilities. Selective conversion of syngas on Fe- and Co-catalysts into a mix of straight chain hydrocarbons was found by Fischer and Tropsch (FT) in the 1920+. A production capacity of 0.6 Mt/a FT-liquids was available in Germany at the end of the world war-2- in addition to the much larger coal liquefaction works by hydrogenation

with a capacity of 3 Mt/a. The largest of the 9 FT-synthesis facilities in Schwarzhede, East Germany, with 0.2 Mt/a capacity was shut-down in 1963. Meanwhile SASOL-company, South Africa, operates large commercial FT-synthesis facilities with a capacity of 6 Mt/a. Fig. 4 demonstrates the state of technology.

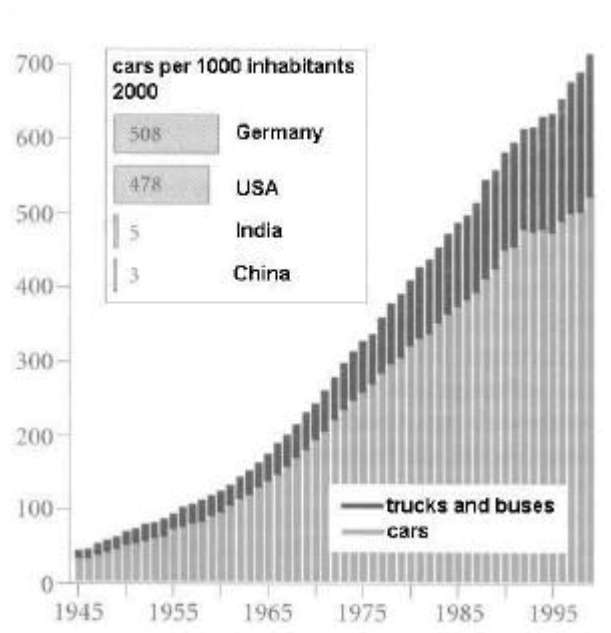

Fig. 2: Evolution of the number of road vehicles in million

fossil fuels ~ 78 %

reserves ~ 140 Gtoe  
consumption 3,5 Gtoe/a

reserves ~ 140 Gtoe  
consumption 2,2 Gtoe/a

reserves ~ 1000 Gtoe  
consumption 2,4 Gtoe/a

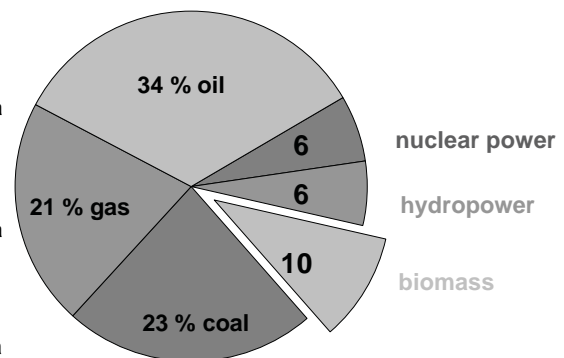
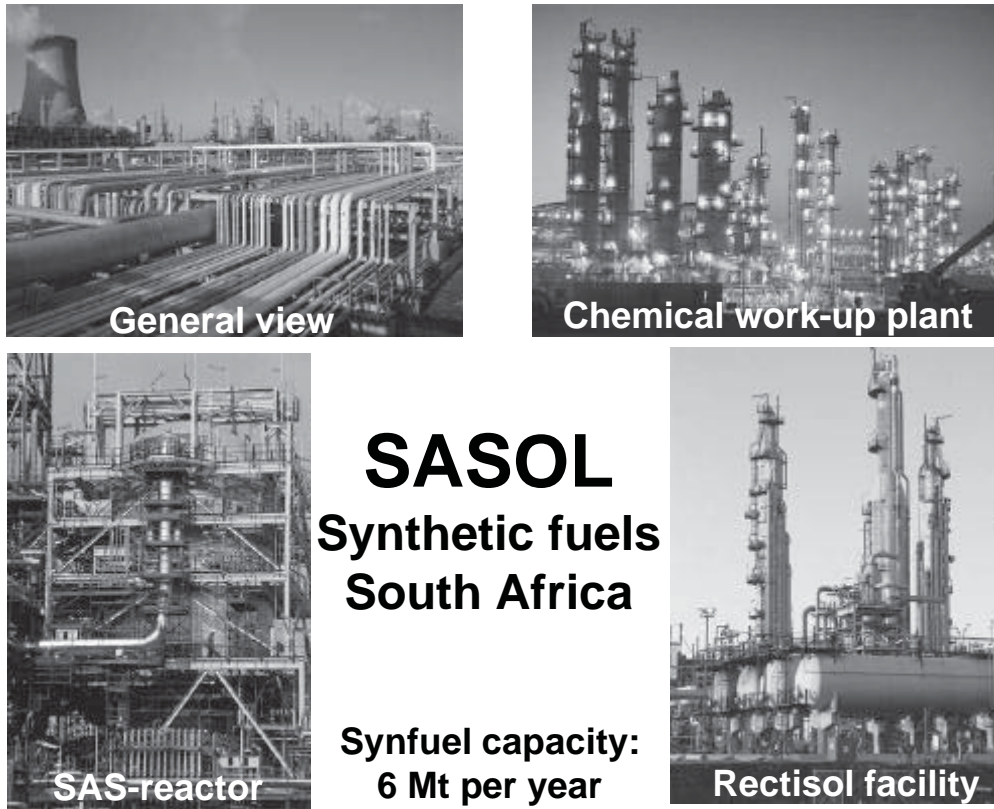
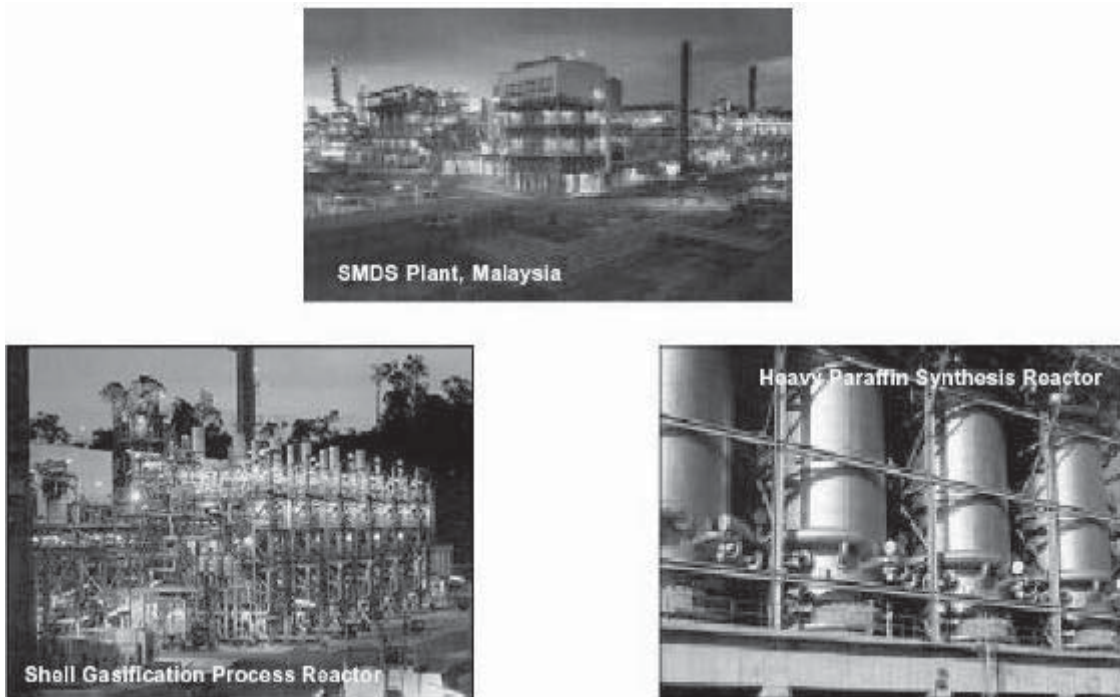

Fig. 3: Primary energy mix 2000



**Fig. 4:** SASOL South African Synthetic Oil Company



**Fig. 5:** SHELL SMDS plant, Bintulu, Malaysia

**Synfuel from natural gas:** Syngas produced from natural gas is used for methanol production but mainly converted into hydrogen for ammonia production. Recently new GTL (gas to liquid) – technology is being developed to convert natural gas into FT-liquids ([www.chemlink.com.ccu/gtl.htm](http://www.chemlink.com.ccu/gtl.htm)). Two commercial GTL-facilities are in operation: SASOL's 23,000 bbl/d Moss gas plant in South Africa, commissioned in 1993 and SHELL's 20,000 bbl/d middle distillate synthesis, Malaysia, built in 1993 (see fig. 5). Mobile company has developed a methanol-to-gasoline (MTG) process using ZSM-5 zeolite catalyst. In New Zealand a MTG-plant was commercialised in 1983, but operation relies on subsidies.

**Synfuel from biomass:** Lignocellulose in form of wood, straw, hay etc. is the most abundant biomass type and comprises about 90% of the global biomass production. Use of food crops for biodiesel (from oil seed) or bioethanol (from starch or sugar crops) is limited and in competition with the production of human and animal food. The energy content of the global food and fodder production is about equivalent to the present transport fuel consumption of 1.8 Gtoe. Conversion of lignocellulosics into synfuel for modern transport vehicles is more efficient than traditional fodder production for transport with animals. The corresponding technology via biomass gasification is similar to coal to synfuel.

Direct use of syngas in gas motors is a historic curiosity. Transport fuel shortage during world war-1 was a bad experience and the French ministry of defense promoted the development of small mobile wood gasifiers for military trucks. The most successful gasifier type was a co-current downdraft wood chip gasifier, developed by Imbert in France. About a million mobile gasifiers have been built in Europe towards and shortly after end of world war-2, not only for trucks but also for cars. The ugly and inconvenient technology with frequent and dirty maintenance operations was quickly abandoned with the availability of cheap oil.

What share of the present 1.8 Gtoe and expected future about 3 Gtoe/a transport fuel consumption can be covered with biomass? Presently, biomass contributes about 1 Gtoe/a to our primary energy consumption. An increase to 3 - 4 Gtoe/a is imaginable with optimal management in forestry, agriculture and organic waste treatment in the future. This potential is large enough to cover the transport fuel demand, at least in principle. But synfuel production is only one of many other potential uses of biomass for energy: residential heating, cooking, ore reduction, high temperature process heat, electricity generation etc. will take their share.

**Competitiveness of synfuel:** This demonstrates that the technology for CH-synfuel production is available at least for coal and natural gas. At present crude oil prices of about 25 US\$/bbl, the technology is not yet competitive against conventional transport fuel production from crude oil in refineries. Exceptions may be smaller gas sources ("stranded" gas) where pipeline transport is not economic or cheap coal and low salaries in combination with a special political situation as e.g. in South Africa. On the long term, with the gradual exhaustion of the conventional and unconventional oil reserves, the oil price will rise and the competitiveness of other carbon resources will improve. Meanwhile, diversification will contribute to supply security.

Synfuels are much cleaner and environmentally compatible than oil-derived fuels. All trace impurities like dust, tar, S (as H<sub>2</sub>S, COS), N (as NH<sub>3</sub>, HCN, HCNO), Cl (as KCl), alkali (KCl, KOH), aromatics etc. must be removed prior to synthesis to prevent poisoning of synthesis catalyst.

With the technology of syngas generation and fuel synthesis, only about half of the biomass energy is converted into FT-synfuel or methanol for thermodynamic reasons. The other half can be partly transformed into power or high temperature heat. If ~ 2 Gtoe or 50% of the maximum global ligno-cellulosic biomass harvest is used for synfuel production, a considerable transport fuel share of ~ 1 Gtoe/a can be realised.



If 10% of the arable land area of 1.3 million km<sup>2</sup> in the EU-15 is used for motor fuel production with a productivity of energy plants of 250 toe/km<sup>2</sup>, this results in 33 Mtoe/a, corresponding to about 10% of the EU-15 motor fuel demand.

**Political targets:** The EU-15 plans (EU-2000, Green Paper) to increase its biofuel share stepwise from 2% in 2005, to 5.75% in 2010 and to 8% or ca. 30 Mtoe in 2020. In Germany biofuels will be tax-free at least until 2008. Renewable fuels will help to mitigate CO<sub>2</sub>-emissions and global warming and reduce our dependence from oil imports.

## WOODY AND HERBACEOUS BIOMASS

The cultivation of energy crops like oil seed for fatty acid methyl esters (FAME) or sugar cane for bio-ethanol etc. plays a minor but special role in view of the far more abundant lignocellulosic biomass in form of wood and straw. Agricultural biomass residues are not woody but herbaceous, have thin walls and are easily dried and stored.

The organic CHO-composition of lignocellulose like wood or straw is not much different and represented approximately by C<sub>6</sub>H<sub>9</sub>O<sub>4</sub>. A more simplified formula is useful for quick estimates: C<sub>3</sub>(H<sub>2</sub>O)<sub>2</sub>. Lignocellulose (~ 50% cellulose, ~ 25% hemicellulose and ~ 25% lignin) may be viewed as a mixture of 50% carbon with 50% water by weight. Wood is a relatively clean fuel with little ash and heteroatoms, without bark usually < 1%. All fast growing herbaceous biomass like straw, hay or leaves etc. contains about an order of magnitude more ash and heteroatoms. The inorganic components are needed as constituents of biocatalysts for the faster metabolism. Typical ash contents of straw or hay are 5 to 10%. Higher ash and heteroatom concentrations are also an indication of higher fertiliser requirements for the faster growing species. Contrary to clean fuelwood, combustion and especially gasification technologies for the poorer herbaceous biofuels are not well developed [HEN 02].

Some special technical problems of herbaceous biomass are: (1.) Dry herbaceous biomass has a low bulk density, e.g. ~ 100 kg/m<sup>3</sup> for straw bales; this increases the storage and transport costs. (2.) The high potassium content lowers the ash sintering temperature sometimes to < 700°C. At combustion or gasification temperatures required for a fast fuel conversion, the ash becomes sticky and increases the risk of reactor slagging. (3.) Most of the chlorine is released as HCl into the gas phase. Consequences are corrosion in heat exchangers and hot gas ducts, poisoning of downstream catalysts or formation of toxic polychlorinated dioxins or furans at unsuitable combustion conditions. (4.) Alkali salts become volatile at temperatures > 650°C; deposition of alkali chlorides, hydroxides or low melting eutectics can cause serious corrosion and plugging of pipes.

There are several options for the removal of K and Cl from the process streams. If the straw swaths are left in the field, K and Cl are washed out on-site with about 0.2 m of rain in the course of several weeks. Another option is counter-current washing of straw chops with hot water in the facility [KNU 98]; this generates about 2 m<sup>3</sup> of waste water with ca. 1% KCl. Airdry straw soaks about its own weight of water; the washed straw has to be dried again. These are unfavourable process characteristics. K and much of the Cl are retained in the pyrolysis char. A hot water wash of the much smaller char amount is probably a simpler step than straw washing [KNU 98]. Sublimation of volatile alkali chloride or other salts from the hot char is another removal option. Without an additional process step, the volatile alkali salts and HCl must be removed from the syngas or flue gas in case of gasification or combustion.

## GASIFIER TYPES FOR STRAW

A rational process selection is only possible after fixation of the biomass educts and of desirable conversion products. Our aim is the economic conversion of agricultural by-products like straw into a highly valuable mix of syngas or organic chemicals and electric power. This is depicted in fig. 6.

The suitability of common gasifier types for straw has been analysed [HEN 02, WIN 78, ROE 97]. Relatively large wood pieces up to about 0.1 m are suited for **fixed bed gasifiers**, either updraft or downdraft. For straw, an expensive pellet or briquette production is required, to maintain a free gas passage through the gasifier bed. But the risk of reactor slagging can not be completely eliminated in this way. **Fluidised beds** operate at typical gasification temperatures of 800 - 900°C. They are well suited for cm-sized wood pieces, since the melting temperature of a typical wood ash is  $> 1000^{\circ}\text{C}$  and high enough. A sticky ash is liberated from straw, which glues together the bed sand and causes breakdown of fluidisation. **Entrained flow gasifiers** require a fine powder, since the conversion must proceed in few

seconds in a flame reaction. Pulverisation of biomass composed of stable cellulose fibres is an expensive procedure. Non of these common gasifiers types is suited for straw or other herbaceous biomass residues. But fluidised beds are suited for pyrolysis up to about  $600^{\circ}\text{C}$ , since the ash remains confined in the pyrolysis char particles.



**Fig. 6:** Aim of a conversion of poor herbaceous biomass into syngas is an economic co-production of valuable syngas or chemicals and electric power.

## BASIC PROCESS DESIGN CONSIDERATIONS

The process concept is based on the following considerations:

- Biomass is the only renewable carbon resource. Use of this unique property for the production of organic chemicals or hydrocarbon syngas has therefore priority.
- A reasonable and principally known technical route is biomass gasification into syngas ( $\text{CO} + \text{H}_2$ ) followed by a selectively catalysed synthesis into FT-syngas, methanol, di-

- methylether (DME) or other organic products or H<sub>2</sub>. Suitable synthesis conditions are at higher temperatures (150 – 350°C) and pressures (20 – 200 bar) in presence of a catalyst.
- A very clean and tar-free syngas is required to prevent poisoning of the sensitive synthesis catalysts. Only entrained flow gasifiers operating at higher temperatures > 1100°C generate a practically tar-free gas. Gasification pressures above synthesis pressure obviate expensive intermediate syngas compression and eases syngas clean-up.
- A special **pressurised entrained flow**, PEF, gasifier has been developed for the salt-containing brown coal from central Germany. This GSP-gasifier will be compatible with high alkali, chlorine and ash contents and fluctuating ash composition of agricultural biomass residuals like straw.
- Any feedstock liquor or slurry with a minimum LHV > 10 MJ/kg, which can be pumped and atomised with pure O<sub>2</sub> in the gasifier chamber is suited for PEF gasification. A dense stream of pulverised biofuel can also be fed in fluidised form via a special air lock system; at higher pressure this requires inconveniently large volumes of lock gas and slurries are preferred.
- A large diversity of gasifier feedstock and synthesis products improves process economy. Potential feedstocks are biomass, fossil fuels and organic wastes. The possibility to produce many different products is of advantage, if the gasifier is part of a large chemical complex.

## TOTAL PROCESS CONCEPT

A pressurised, clean and undiluted syngas is required for an **efficient synthesis procedure**. Gasification at higher pressure above the downstream synthesis pressure and the use of oxygen instead of air is therefore desirable. This obviates intermediate syngas compression, avoids syngas dilution with inert N<sub>2</sub> from air and eases efficient cleaning of the smaller syngas volume, which is necessary to prevent poisoning of the sensitive synthesis catalysts.

Selective production of methanol [ERT 97, vol. 4, p. 1856], dimethylether (DME) [ULL 02], hydrocarbon fuels [ERT 97, vol. 4, p. 1876], oxo-alcohols etc. from syngas are well known technical processes. Low pressure synthesis of CH<sub>3</sub>OH for example, proceeds with a H<sub>2</sub>/CO-ratio of 2+ at Cu-catalysts at ~ 250°C and ~ 50 bar. A Fischer-Tropsch synfuel production requires a similar H<sub>2</sub>/CO-ratio and special Fe or Co catalysts at 200 to 300°C and 20 to 40 bar. DME is a potential neat diesel fuel; the optimum H<sub>2</sub>/CO-ratio for DME synthesis is about 1. All selective syngas catalysts are highly sensitive to many trace poisons: S-, Cl-, N-, metal

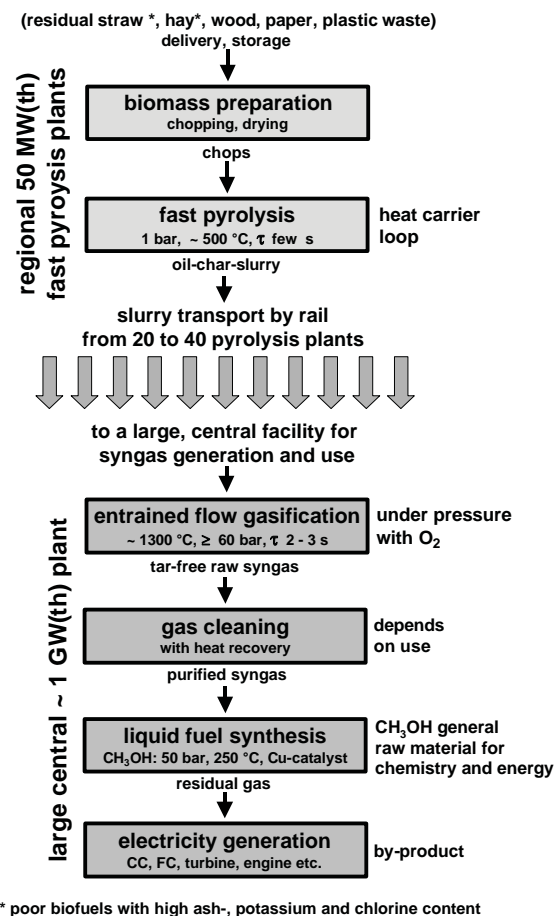

Fig. 7: Sequence of process steps for the efficient use of poor herbaceous biomass with high ash content.

compounds, tar constituents etc.. Cleaning and conditioning of the raw syngas is a considerable and expensive technical effort.

A practically tarfree syngas can be generated at higher gasification temperatures  $\geq 1100^{\circ}\text{C}$  in a pressurised entrained flow gasifier. At such temperatures, a large fraction of 20 - 30% of the initial biomass energy is not converted into chemical energy of CO and H<sub>2</sub>, but is present as sensible heat in the hot syngas. Since both energy forms must be used to achieve an efficient process, the synfuel or chemicals production from CO and H<sub>2</sub> must be combined and complemented by using the high temperature heat for electric power generation.

Generation and use of syngas for synfuel or chemicals production requires sophisticated technology. Large technical plants take advantage of the economy of scale. With a typical cost depression exponent of 0.7 for this type of chemical facilities, the specific investment costs are about halved for a 10 times larger plant. With a total transport fuel consumption of 65 Mt/a in Germany, only plants with a production of at least 1 Mt/a can make a reasonable and cost-efficient contribution. Plants for 6 Mt/a synfuel production from coal are operated by "Sasol" (South African Synthetic Oil), South Africa. At SVZ, Schwarze Pumpe, Germany, a mix of solid wastes and brown coal is gasified for the co-production of CH<sub>3</sub>OH and electric power in a combined cycle system [SEI 00].

Large facilities for synfuel or chemicals production are not compatible with the distributed arisings especially of agricultural biomass residues. A technically simple biomass liquefaction process would be an ideal preparation step for a compact tank storage and easy transport into a large central gasification facility. A liquor is also easily pumped and atomised into a highly pressurised entrained flow gasifier. The total process sequence is outlined in fig. 7 [HEN 02a, HEN 02].

In rural European areas, about half of the cereal straw harvest (total ca. 500 t/km<sup>2</sup> on the average) is available as an unused surplus. A large delivery radius of > 100 km would be necessary for an economic, large central plant for syngas generation and use. For straw bales with  $\sim 100 \text{ kg/m}^3$  bulk density, a maximum delivery distance of 20 or 30 km is at the limits of practicability for the local farmers. As outlined in fig. 8, regional fast pyrolysis facilities with  $\sim 25 \text{ km}$  delivery radius are a suitable size. This corresponds to a throughput of 100 000 t/a of airdry straw and strawlike biomass residues from 2000 km<sup>2</sup> area. The output is about 10 t/h of pyrolysis oil/char slurry, which is easily pumped and stored in tanks. From 20 or more of these regional pyrolysis plants, the slurries are transported up to  $\sim 300 \text{ km}$  by rail – for 10 to 20 €/t freight – to the tank storage farm of a large central

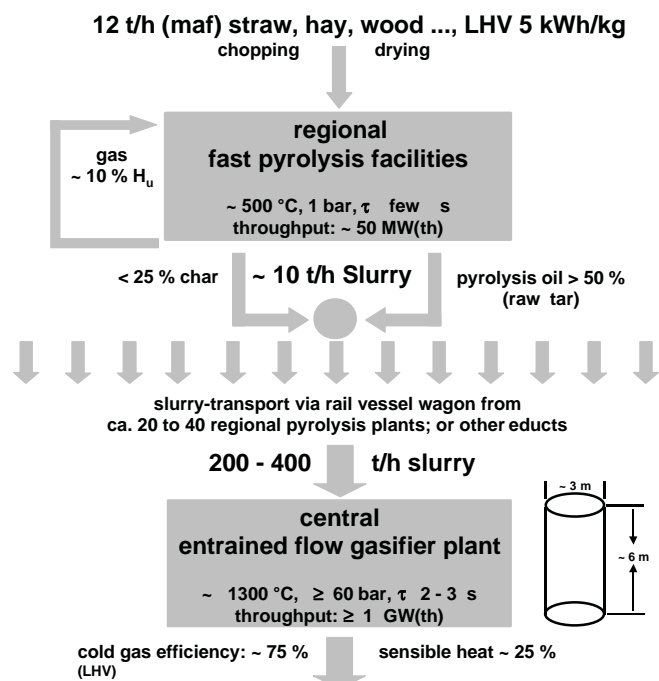

**Fig. 8:** An essential characteristic of the process is biomass liquefaction in many regional fast pyrolysis plants, followed by transport of a pyrolysis oil/char-slurry to a large central plant for syngas generation and use.

gasifier plant. If the char particles suspended in the slurry are small enough, the liquor can be pumped into a pressurised entrained flow gasifier and atomised without much preparation.

## BIOMASS PREPARATION STEPS [PYNE, BRI 99]

In the following, straw is used as a synonym for all thin-walled and fast drying biomass residues from agriculture, which contain much ash, K and Cl.

**Straw delivery and storage:** Cereal straw is harvested during few weeks per year. In-time delivery to a small ca. 1 week intermediate storage facility at a the pyrolysis plant site can be ensured by contracts with the local farmers, as is known from Danish district heating and CHP-plants [LAR 98]. Large ca. 0.5 t square bales with ca. 120 kg/m<sup>3</sup> bulk density are a convenient and economic form. Stable storage requires low = 15% moisture.

**Straw chopping:** Low energy consumption is expected from a two-step process using a chaff-cutter followed by a hammer mill [MAI 98]. Thick stem nodes contribute about 5% to the straw mass. They are a bottle neck for fast pyrolysis and must be squeezed. The thin walls of straw stems or grass blades obviate an extreme size reduction: The characteristic length  $L = \text{volume/surface}$  of a thin flat plate does not change much with the cutting length of smaller chops.

**Drying and heating of straw chops:** Moisture reduction and prewarming of the straw chops can considerably reduce the heat requirements in the pyrolysis process itself. This effect is amplified by an exothermal pyrolysis section of lignocellulose, which results in an automatic, self-sustained heatup from about 300 to ca. 400+°C.

The fast temperature rise is connected with the release of the bulk of condensable organic vapours. Self-sustained wood pyrolysis has been observed at pre-heating temperatures of 150+°C [RIE 33]. The practical benefit of a smaller specific heat input is a higher pyrolysis reactor throughput or a flow reduction in the sand loop of a pyrolysis reactor using sand as heat carrier.

## FAST PYROLYSIS

**Fundamentals:** Fast or flash pyrolysis [BRI 99] ([www.pyne.co.uk](http://www.pyne.co.uk)) is a technically relatively simple liquefaction method for relatively dry lignocellulosic biomass. At special

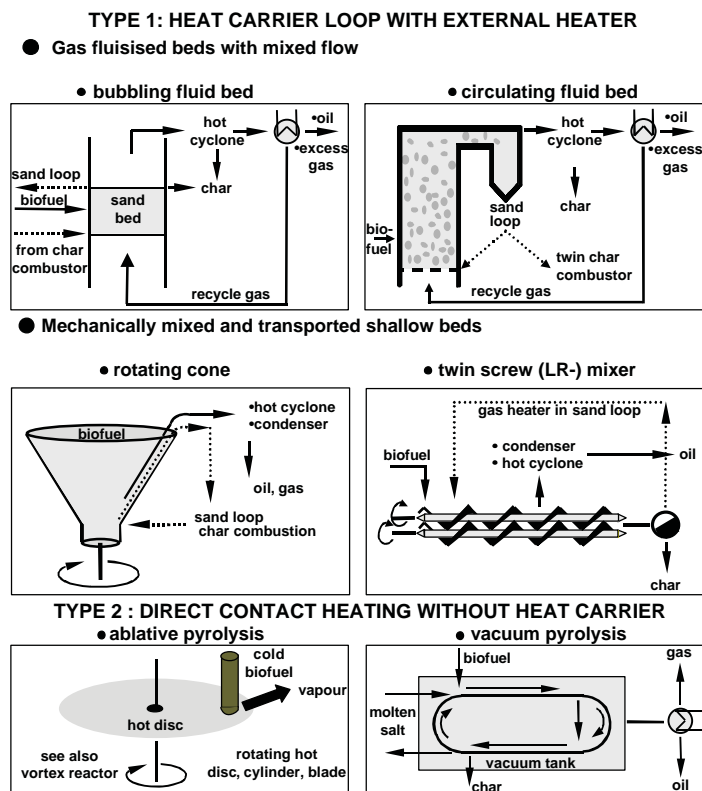

**Fig. 9:** Various reactor types, which are being investigated for the fast pyrolysis of biomass. Fluidised beds are the most common type.

operating conditions, high yields of 50-75% wt. of condensable pyrolysis oil and little pyrolysis char and pyrolysis gas are obtained. In an air-free atmosphere at ambient pressure, thin or small dry biomass particles are quickly heated to  $\sim 500^{\circ}\text{C}$  by mixing with an excess of hot sand or another heat carrier. Organic and water vapours are produced by biomass decomposition and are quickly removed and condensed in the course of 1 or few s by direct quenching with an excess of cold recycled condensate. At higher temperatures or longer residence times the condensable organic vapours are decomposed to gas and char. The optimum temperature window at  $\sim 500^{\circ}\text{C}$  is rather narrow:  $100^{\circ}\text{C}$  below the optimum, the primary biomass decomposition rate becomes too slow;  $100^{\circ}\text{C}$  above, the secondary decomposition of the organic vapours to char and gas becomes too fast and reduces the liquor yield.

**Reactor types:** Various reactor types are being investigated for fast pyrolysis and are depicted in fig. 9. Most types use hot sand as heat carrier. A large specific biomass surface ensures good contact and fast heat transfer. The reciprocal of the specific surface is the characteristic length  $L = \text{volume/surface}$  and usually given for particle characterisation. Usual techniques for liquor recovery by quench condensation do not allow an efficient heat recovery from the hot vapours and gases. The fluidisation of bubbling or circulating fluidised sand beds is normally maintained by recycling cold pyrolysis gas from downstream of the condenser. Quenching of the additional fluidisation gas flow increases the thermal losses. This energy loss can be avoided by mechanical “fluidisation” either with the rotating cone reactor [WAG 94] or the twin-screw mixer reactor [WEI 00].

*Ablative pyrolysis* may be explained by wiping off a thin film of molten lignocellulose by friction on a fast moving  $600\text{-}700^{\circ}\text{C}$  hot surface, followed by a fast film evaporation. So far, this principle has been applied only in laboratory-scale investigations. Another principle is *vacuum pyrolysis*, which combines a moderate heatup-rate for larger particles with a very small vapour residence time at reduced pressure of ca. 0,1 bar. Vacuum operation has been successfully tested up to the technical scale. Evacuation can also be combined with other techniques, but the additional technical effort must be justified.

**Choice of a fast pyrolysis reactor:** The short residence time of gas, vapour and solids in the fast pyrolysis reactor results in a small volume, too small for the installation of a large internal heat exchanger to reheat the sand. The heat requirement corresponds to about 10% of the biomass heating value. Therefore, the hot sand has to be recycled in a closed loop via a large external sand heater. In the rotating cone technology, the sand stream is reheated by char combustion directly in the bed of a second, separate fluidised reactor. In this case, liberation of a sticky ash e.g. from straw, involves the risk of sand agglomeration at higher combustion temperatures.

If the char is recovered together with the pyrolysis liquid in a slurry for subsequent gasification, the pyrolysis gas can supply the energy for the pyrolysis process. The ash containing char particles must than be separated from the loop sand.

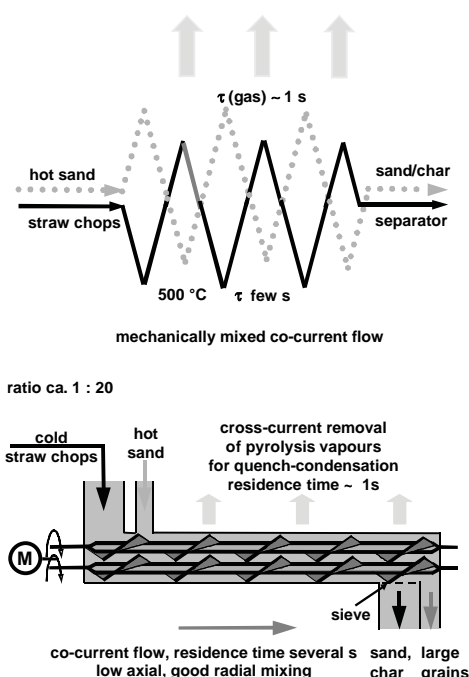

**Fig. 10:** Axial transport in the twin-screw mixer reactor takes several s, with poor axial and good radial mixing. There is technical experience for the fast pyrolysis of various refinery products

Later on, the ash in the char particles is needed anyway for the formation of a protecting slag layer in the gasification chamber.

Pyrolysis rates of biomass particles are usually controlled by heat transfer and not by the relatively fast chemical decomposition reactions. In this simplified picture, pyrolysis is finished

when the particle centre has reached a definite "decomposition temperature". The contacting patterns of heat carrier and biomass particles are therefore an essential design feature for the pyrolysis reactor. In a co-current flow with poor axial and good radial mixing, a high conversion is obtained, if the residence time of the sand/biomass mixture exceeds the finite and relatively short pyrolysis time. This concept is applied in the rotating cone and twin-screw mixer reactors in combination with fast cross-current vapour removal from a shallow fluidised bed as shown in fig. 10. The residence time distribution of solids in a bubbling or circulating fluidised bed reactor is about exponential. This is undesirable, because it requires a much larger residence time and therefore a larger bed volume for a comparable degree of conversion.

**Pyrolysis kinetics and reactor design:** Single-walled straw chops of about 1 cm length have been plunged from a cold lock into a vessel onto a hot moving sand bed. The release rate of the vapours and gases has been followed by the pressure rise in the closed vessel with known volume. Typical examples are shown in fig. 11. At 500°C, the volume of pyrolysis vapours and gases amounts to about 0.5 m<sup>3</sup>(STP) per kg. Within experimental error, the measured release rates are consistent with the theory of unsteady-state heating of particles using the Fourier-number  $Fo = a \cdot t/L^2$

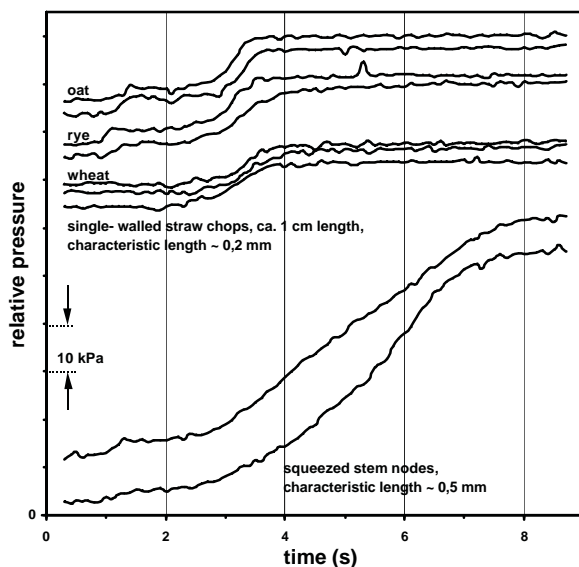

**Fig. 11:** pressure rise during pyrolysis of straw chops on a moving sand bed at 500°C in a closed vessel. Pyrolysis time for thin straw walls is ~ 1 s; squeezed stem nodes need several s..

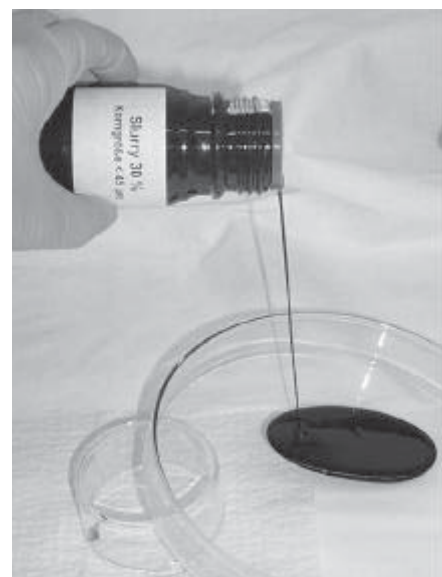

**Fig. 12:** Oil/char slurries are prepared by mixing pyrolysis oil with up to ~ 1/3 wt. of pulverised pyrolysis char. Viscosity at 20°C is several Poiseuille.

with  $a = k/(d \cdot C)$  and the Biot-number  $Bi = h \cdot L/k$  and the following material properties: thermal conductivity  $k = 0.1 - 0.3 \text{ J/s} \cdot \text{m} \cdot \text{K}$ ; specific heat  $C \sim 1.8 \text{ kJ/kg}$ ; density  $\rho \sim 1000 \text{ kg/m}^3$ ; heat transfer coefficient  $h = 100 - 200 \text{ J/m}^2 \cdot \text{k} \cdot \text{s}$ ; characteristic length  $\sim 0.2 \text{ mm}$ .

The vapours are released from the single-walled chops in about 1s. This is within expectation, if the surface resistance is assumed to dominate the heat transfer, at least until ~ 300°C centerplane temperature are reached and exothermic pyrolysis reaction induce a fast vapour re-

lease. The nodes of straw stems contribute 5+% to the straw weight. Even after squeezing with a hammer to < 1mm, the pyrolysis takes several s and becomes a bottle neck for the pyrolysis time.

The conclusion from these measurements is, that a pyrolysis time of ~ 10s seems to be sufficient. For a straw throughput of 4kg/s (50 MW(th) power or 100 000t/y) this results in a small sand bed volume of only ~ 0.5 m<sup>3</sup>. At 500°C and 1 bar about 8 m<sup>3</sup>/s of pyrolysis vapours and gases are released. To prevent carry-over of sand particles at high superficial velocities > 2 m/s, the bed surface area should be larger than ~ 4 m<sup>2</sup>. This results in a shallow bed height of < 0,2 m and a short vapour contact time for crosscurrent vapour removal. A short total gas residence time of = 1 s is obtained, if the volume of the ducts and the char removal cyclone upstream from the quench condenser is kept at < 8 m<sup>3</sup>.

**Process development unit (PDU):** A PDU for continuous fast pyrolysis of 10 kg/h dry ligno-cellulose in form of straw chops, hay, sawdust, paper/cardboard etc. is under construction. The simplified flowsheet is outlined in fig. 13. Essential part is a hot sand loop with a twin-screw mixer reactor and a sand heater. Various feedstocks, operating conditions and different component types will be tested and compared. The choice between mechanical and pneumatic sand transport will be based on practical experience. The same is true for the various sand/char separation options and the separation of K and Cl from the process streams. When the twin-screw pyrolyser works as expected, a larger pilot facility will be built determine data for a demonstration plant.

## SLURRY PREPARATION

If possible, the total char yield should be suspended in the pyrolysis oil. Therefore, the *fast* pyrolysis process with high liquor and low char yield has been selected. In spite of the high char concentration, the slurries should be easily pumpable, free-flowing and pneumatic atomi-

sation for spray production should be possible. It is known from rheology [MAC 94] that free-flowing slurries with spheric particles can be prepared up to a critical volume fraction of  $\emptyset(\text{crit.}) \sim 60\%$ . For regular particles with an aspect ratio of ~ 1,  $\emptyset(\text{crit.})$  is ~ 50%; for platelets, needles etc.  $\emptyset(\text{crit.})$  can be <0.2. A broad particle size spectrum allows a higher  $\emptyset(\text{crit.})$  than a narrow one.

The brittle pyrolysis chars from biomass are easily milled with a broad size spectrum. Char powder can be suspended in the pyrolysis oil by simple agitation. But the high porosity of the

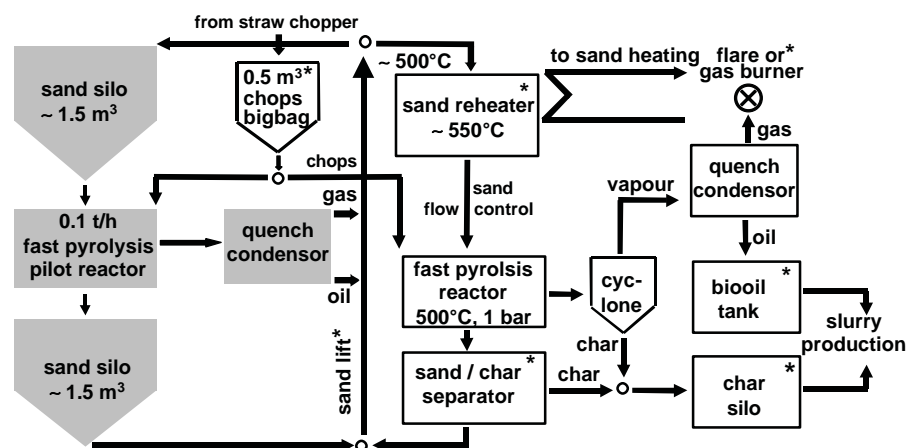

**Fig. 13:** Simplified scheme of the fast pyrolysis process development unit for a throughput of 10 kg/h of straw chops or sawdust.



pyrolysis chars, typically between 50 and 80%, prevents a high loading. Porous particles first soak a lot of pyrolysis oil until a sufficient volume is available outside the particles to serve as a lubricant.

Experiments have been performed with pyrolysis oil (= raw tar) from commercial charcoal production from beechwood: density  $\sim 1200 \text{ kg/m}^3$ . The true density of the corresponding charcoal powder has been  $1500\text{-}1600 \text{ kg/m}^3$ . A maximum volume fraction of char of  $\sim 50\%$  corresponds to a maximum weight fraction of  $1/3$ . With char particles  $< 50 \mu\text{m}$  free flowing slurries with 30 and 33% maximum char weight have been prepared: density  $\sim 1300 \text{ kg/m}^3$ ; the room temperature viscosity of several Pas is reduced by about an order of magnitude at  $80^\circ\text{C}$ . This eases pneumatic slurry atomisation in the gasifier. LHV is in the range of 6 kWh/kg: A self-sustained gasification with  $\text{O}_2$  becomes difficult below  $\sim 3\text{ kWh/kg}$ . The highly concentrated slurries have been stored over several month without a stabiliser; there was negligible viscosity change and sedimentation.

### SYNGAS GENERATION AND USE

Generation and use of syngas for the production of synfuel or other chemicals involves a combination of complex technologies. This is realised more economically in a large central plant, supplied with pyrolysis slurries from 20 - 40 regional pyrolysis plants. Economic operation always at full capacity is easier, if the selected gasifier type can digest not only various organic liquors and slurries, but also other feedstocks like natural gas and pulverised coal. In addition to the feedstock flexibility a larger product diversity and flexibility can be obtained, if the central gasifier is integrated into a large industrial chemical complex.

**Pressurised entrained flow gasification:** The selected pressurised entrained flow gasifier has been

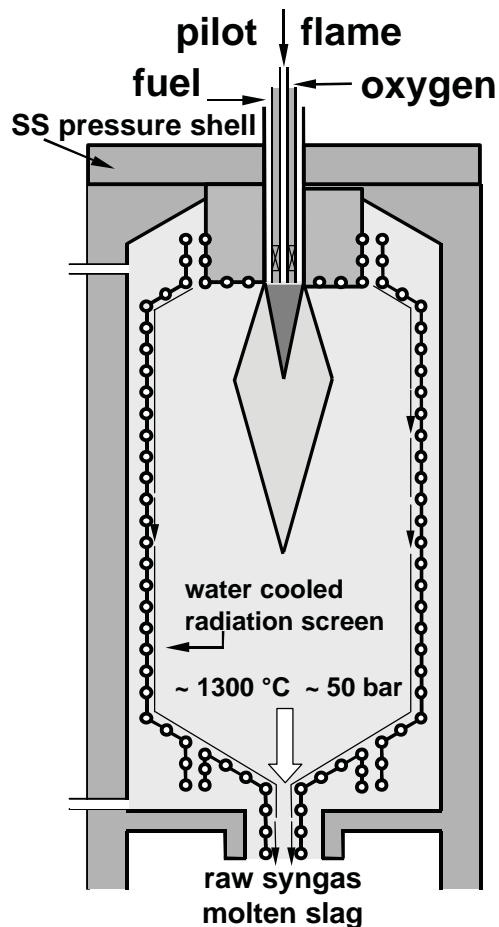
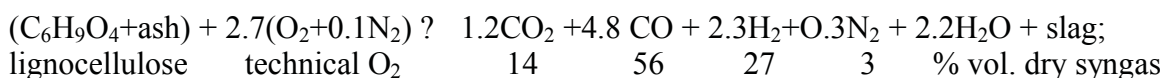

**Fig. 14:** Slugging entrained flow gasifier for operation at high temperature and pressure. The characteristic radiation screen with SiC-liner, is cooled with pressurised water, to keep the pressure resistant steel shell at low temperatures.

developed about 30 years ago by the previous “**Deutsches Brennstoff-Institut**” (DBI), Freiberg, Germany [SIN 02, CAR 94] for the gasification of the salt-containing brown coal from central Germany. In the SVZ-facilities at “Schwarze Pumpe”, Germany, a 130 MW(th) gasifier of this GSP-gasifier type is being operated successfully since more than 15 years with various feeds [SEI 00]. The simplified construction in fig. 14 shows the characteristic inner radiation screen, cooled with pressurised water, inside a pressure-resistant steel shell. A specially designed SiC-lined screen permits operation with fuels, having a high and fluctuating ash content and composition. The molten, viscous slag layer drains down and protects the inner reactor wall from corrosion. Gasification temperatures and slag draining are controlled with the oxygen flow.

At the usual operating temperatures of 1200 – 1600°C, the very hot syngas is practically tar-free because of the high gasification temperature. But a higher percentage of 20-30% of the feed energy is converted into less valuable sensible heat of the hot syngas. The sensible heat can be partly recovered for electricity generation, which is a necessary by-product of a chemical synthesis. Partial reconversion of the high temperature heat into chemical energy by chemical quenching with char powder has been proposed [WOL 00] but requires much technical effort [HEN 02a].

High gasification temperatures and pressures allow an almost complete fuel conversion and an approximate product gas equilibration. A crude estimate of material and energy balances is thus possible from known thermodynamic data, as shown for dry lignocellulose, C<sub>6</sub>H<sub>9</sub>O<sub>4</sub>, in the following equation:



The elementary composition of oil / char-slurries is not much different from lignocellulose. The amount of O<sub>2</sub> in the reaction equation corresponds to about half of the slurry weight, thus making a significant cost contribution (technical O<sub>2</sub> ~ 60 €/t).

**First slurry gasification campaign:** Pneumatic atomisation and gasification of concentrated char/oil-slurries with pure pressurised O<sub>2</sub> is the essential new step in the proposed gasification concept. This was tested on the engineering-scale in the 5+MW(th) pilot gasifier at the Babcock Borsig Power facilities in Freiberg, Germany (previously Noell, now Future Energy company). Slurries have been prepared from the products of commercial beechwood pyrolysis for charcoal production, using the Degussa process [BRO xx]. The pyrolysis oil is termed "raw wood tar" and easily available in large amounts as a by-product. The purchased oil (Chemviron company) had a density of 1184 kg/m<sup>3</sup>, a room temperature viscosity of 0.16 Pas and a LHV of 19 MJ/kg. Charcoal dust had a LHV of 31-32 MJ/kg and has been further pulverised to <50 µm prior to slurry preparation.

The oil/char suspension was continuously recycled via a large storage tank and a 1m<sup>3</sup> PE-mixing vessel equipped with a heater and stirrer. Slurries with 20, 23 and 26% wt. charcoal powder have been prepared by slow char addition to the stirrer until the desired concentration was attained. To simulate a slag layer in the gasifier, characteristic for agricultural biomass residues, 3% wt. of straw ash (from the district heating plant Schkölen) - plus 0,3% KCl to readjust some Cl-losses - have also been added. The following slurry properties have been measured: LHV 21-22 MJ/kg; density 1250+ kg/m<sup>3</sup>; the room temperature viscosity of 2-5 Poiseuille (PI) is reduced by an order of magnitude at 80°C.

**Operating conditions:** A constant flow of 350 kg/h (2MW(th)-power) of the warm slurry was fed with a screw pump into the gasifier chamber at 26 bar. This throughput corresponds

to a residence time of 4-5 s. The slurry was atomised pneumatically with pure, pressurised O<sub>2</sub> in a special nozzle. A 0,6 MW(th) pilot flame of natural gas (50 Nm<sup>3</sup>/h) was maintained simultaneously for safety reasons and to compensate for the heat loss via the ca. 3m<sup>2</sup> surface area of the radiation screen. Because of the smaller surface-to-volume ratio, this heat loss becomes negligible in large gasifiers. At the exit of the gasifier chamber, the hot syngas and the slag have been quenched by water injection.

**Results:** In the first experimental campaign a total of 8 t of slurry have been gasified. A gasification temperature of 1300-1600°C has been achieved with an O<sub>2</sub>-stoichiometry of  $\lambda = 0.4 - 0.5$ . After a parameter change - except ash composition - stationary thermal conditions have been approached in only 1h and a stable operation has been maintained for additional 2+ h. No problems with slag removal have been observed. The carbon conversion was determined from the residual carbon content in the slag and the quench water. All carbon conversion percentages were found definitely > 99% and ca. 99.9% at the highest temperatures. Two examples for the composition of the dry, quenched raw syngas are:

**Table 2:** Composition of the dry syngas from pressurised slurry gasification with O<sub>2</sub>.

		CO	H <sub>2</sub>	CO <sub>2</sub>	N <sub>2</sub>	CH <sub>4</sub>	H <sub>2</sub> S	tar
? (O <sub>2</sub> ) 0,46	%Vol.	45	29	18	9	<0,1	29 ppmv	-
? (O <sub>2</sub> ) 0,42	%vol	47	27	16	9	<0,1	17 ppmv	-

The raw syngas is practically tar-free, CH<sub>4</sub> is <.0.1% vol. In a large > 100 MW gasifier, the heat loss via the radiation screen is much lower and the O<sub>2</sub>-consumption (?) can probably be reduced by 10 - 20%; inert protective gas streams e.g. N<sub>2</sub>, can also be reduced to few percent. The top of the pilot gasifier is shown in the photo of fig. 15.

## SYNGAS CLEANUP AND CONDITIONING

Application of syngas as a fuel gas for the generation of process heat or steam cycle power or as reduction gas for ore reduction is possible with little gas cleaning. Electricity generation in gas motors or turbines requires some more technical effort. The most demanding utilisation steps are the synthesis of chemicals or fuels. Practically all impurities (S, Cl, N, alkali, heavy metals, tar, dust etc.) must be removed to the sub-ppm level. In addition, the H<sub>2</sub>/CO-ratio must be adjusted via the catalysed shift reaction,  $\text{CO} + \text{H}_2\text{O} \rightleftharpoons \text{CO}_2 + \text{H}_2$ ; and the CO<sub>2</sub> must be removed for release, disposal or utilisation. In the chain from syngas generation to the final synthesis, the syngas clean-up and conditioning steps are the most expensive procedures.

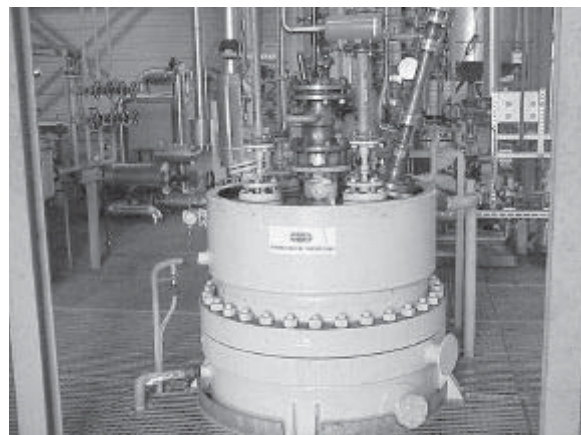

**Fig. 15:** Top of the 5+ MW(th) pilot scale pressurised entrained flow gasifier at Babcock Borsig Power (BBP), Freiberg, Saxony.

## USE OF HIGH PRESSURE SYNGAS

Usually the syngas conversion to methanol, DME or Fischer-Tropsch (FT) – diesel [VEN 02, HAM 02, OUW 02] is considered, since no additional chemicals are required. These catalysed synthesis reactions require high pressure, adjustment of the  $H_2/CO$  ratio to ca. 2 (or 1 for DME) and an efficient and expensive syngas-purification to protect the selective but sensitive catalysts from a number of trace poisons. These synthesis technologies are well known and are used since more than 60 years with syngas from fossil fuel, especially coal. Methanol and DME are versatile products and can be used in different ways: (1.) as direct motor fuel or additive; (2.) as a compact storage medium for  $H_2$ , produced in the catalysed reforming reaction with water; (3.) conversion into a CH-synfuel via the zeolite-catalysed MTG-process; (4.) zeolite catalysed conversion into olefins or aromats in the zeolite-catalysed MTO-and MTA-processes. Olefins and aromats are base chemicals for the chemical industry.

A more economic synthesis process is expected, if a high synthesis yield is obtained in a *single pass* through the catalysts bed and the small volume of unconverted rest gas plus any couple- or side-products are then directly combusted in an efficient combined-cycle system without expensive gas recycle. The rest gas is clean enough for a turbine, since the purity requirements for the upstream catalyst are far more restrictive.

High single-pass yields are possible in the FT-process for thermodynamic reasons. In the favoured low pressure  $CH_3OH$ -synthesis at ca. 50 bar and  $250^\circ C$  using highly selective Cu-catalysts, a maximum thermodynamic yield of only  $\sim 30\%$  can be obtained. In recent years, there is a growing interest in dimethylether,  $CH_3-O-CH_3$ , as an environmentally compatible, neat diesel fuel. Similar to  $CH_3OH$ , there is also the potential use as a base chemical for the production of olefins and acetic acid [ULL 02]. High single-pass yields for  $CH_3-O-CH_3$  up to 90% are theoretically possible [ADA 00].

## ECONOMIC CONSIDERATIONS

A crude estimate of the production costs for  $CH_3OH$  (5.5 kWh(th) per L) or FT-liquids (10 kWh(th) per L) or electricity is plotted in fig. 16 as a function of plant capacity. Basic assumptions are as follows: straw (15% moisture) at the plant site 60 €/t, rented  $O_2$ -production plant 8 c€/Nm<sup>3</sup>, 300 km slurry transport by rail 18 €/t, specific plant investments: for a 50 MW(th) pyrolysis plant 250 €/kW(th), for a 1 GW(th) product central slurry gasification and synthesis plant 500 €/kW(th). Cost depression exponents: plants 0,7; personnel 0,25; cost per

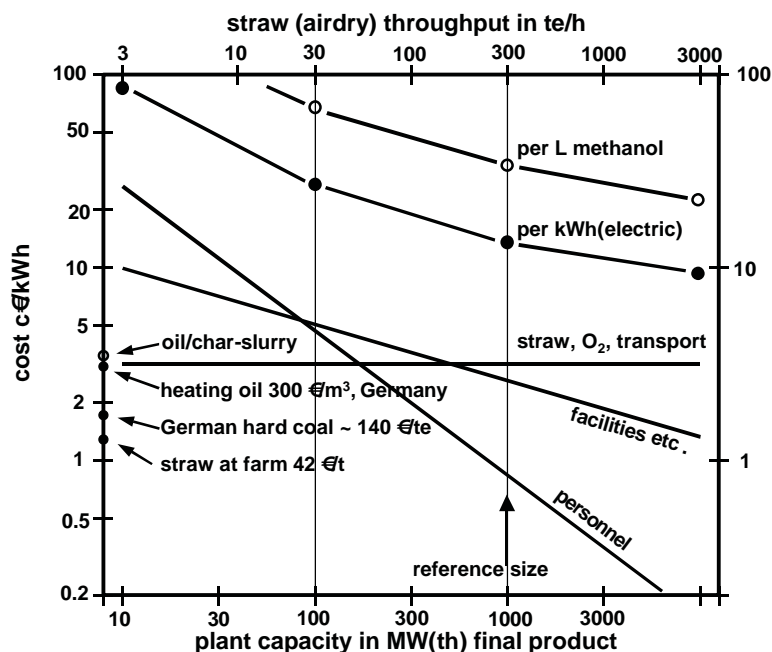

**Fig. 16:** Cost estimate for methanol and electricity from biomass as a function of plant capacity. Technology changes over the large capacity range are not considered.

capita and year 60 k€. Thermal energy losses: 10% in the pyrolysis as well as in the gasification facilities.

The cost for straw (residual wood etc.), transport and technical O<sub>2</sub> is almost independent from plant capacity. The fixed and variable costs for the plant and the personnel depend on the capacity. Only in very large plants with a capacity in the range of 1 GW(th) or more, the size-independent biomass feedstock and transport costs become dominant. Then, plant cost and further technology development do no more play the decisive role. But in developing countries with low biomass and labour costs, there is still an incentive for further technical simplifications. Compared with the expensive oil imports in these countries, synfuel production from domestic biomass will be competitive at lower crude oil prices than in the industrialised countries. In Europe the technology can be competitive with taxed transport fuel; compared to untaxed fuel the price is at least twice.

## REFERENCES

- ADA 00 Y. Adachi, M. Komoto, I. Watanabe, Y. Ohno, K. Fujimoto; Fuel 79 (2000) 229 - 234
- BRI 99 A. Bridgwater et al.; "Fast Pyrolysis of Biomass", a Handbook; cpl-press, UK, vol. 1 1999, vol. 2 2002
- BRD G. Brocksiepe; „Holzverkohlung“, Ullmann Encyklopädie der technischen Chemie, Bd. 12, S. 703
- CAR 94 J. Carl, P. Fritz (eds.); "Noell Konversionsverfahren zur Verwertung und Entsorgung von Abfällen", EF-Verlag; Berlin 1994
- ERT 97 G. Ertl, H. Knözinger, J. Weitkamp (eds.); "Handbook of Heterogeneous Catalysis", vol. 1-5
- EUG 00 EU Greenbook 2000;
- FIS 03 Der "Fischer Weltalmanach 2002", ed. M. von Baratta, Fischer, Mannheim 2002
- HAM 02 C. N. Hamelinck, A.P.C. Faaij, H.P. Calis, H. den Uil, H. Boerrigter; 12<sup>th</sup> EU-Conf. Biomass for Energy and Industry, 17-21 June 2002, Amsterdam, NL p. 1174
- HEN 02 E. Henrich, F. Weirich; Proc. IT3 '02 Conf., May 13-17, 2002, New Orleans, LA, USA;
- HEN 02a E. Henrich, E. Dinjus, D. Meier; DGMK Tagungsbericht 2002-2, S. 95
- IEA 01 IEA, "World Energy Outlook, 2001 Insights", OECD/IEA, Paris 2001
- KAL 98 M. Kaltschmitt, C. Roesch, L. Dinkelbach (eds.); "Biomass Gasification in Europe", AIR3-CT-94-2284, EUR 18 224 EN, October 1998;
- KAL 01 M. Kaltschmitt, H. Hartmann (Hrsg.); „Energie aus Biomasse“, Springer, Berlin 2001,
- KNO 98 N. O. Knudsen, P. A. Jensen, B. Sander, K. Dam-Johansen; 10<sup>th</sup> EU-Conf. Biomass for Energy and Industry, Würzburg, Germany 1998, Proceedings p. 224
- KOJ 98 T. Kojima, „The carbon dioxide problem“, Gordon and Breach Science Publishers 1998
- LAR 98 M. G. Larsen; Proc. 10<sup>th</sup> EU-Conf. Biomass for Energy and Industry, Würzburg, Germany 1998, Proceedings p. 1196
- LEI 02 L. Leible, A. Arlt, H. Seifert, S. Kälber, E. Nieke, D. Wintzer, B. Fürniss; DGMK Tagungsbericht 2002-2, S. 63
- MAC 94 C.W. Macosko; "Rheology", VCH Weinheim 1994;
- MAI 98 J. Maier, R. Vetter, V. Siegle, H. Spliethoff; Abschlussbericht zu Forschungsvorhaben Ord. Nr. 22-94.11, Ministerium für Ernährung und Ländlichen Raum Baden Württemberg 1998

- OUW 02 K.D. Ouwens, A. Faaij; 12<sup>th</sup> EU-Conf. Biomass for Energy and Industry, 17-21 June 2002, Amsterdam, NL
- PYNE [www.pyne.co.uk](http://www.pyne.co.uk);
- RIE 39 E. R. Riegel; Industrial Chemistry, ed. 2, p. 253, The Chemical Catalog Company, New York 1933
- ROE 97 C. Roesch, W. Wintzer; Vergasung und Pyrolyse von Biomasse, TAB-Arbeitsbericht Nr. 49, Bonn 1997
- SEI 00 W. Seifert, B. Buttker; DGMK Tagungsbericht 2000-1, p. 169-197;
- SIN 02 Schingnitz; Chemie-Ingenieur Technik (74) S. 776, 7/2002
- ULL 02 Ullmann's Encyclopedia of Industrial Chemistry, 6 ed. 2002, electronic release: Dimethyl ether
- VEN 02 R. H. Venderbosch, L. van de Beld, W. Prins; 12<sup>th</sup> EU-Conf. Biomass for Energy and Industry, 17-21 June 2002, Amsterdam, NL p. 556
- WAG 94 M. Wagenaar; „The Rotating Cone Reactor“, PhD-thesis, Twente-University (NL). 1994
- WEI 00 H. Weis, V. F. Pagel; 16<sup>th</sup> World Petroleum Congress, Calgary (CA), 2000
- WIN 81 Winnacker-Küchler; „Chemische Technologie“, Bd. 5, 1981
- WOL 00 B. Wolf, B. Meyer; DGMK Tagungsbericht 2000-1, p. 205

## **SunFuel® – Fuel for future drive systems**

Dipl. Ing. H. Nannen, Volkswagen AG, Wolfsburg  
Dr.-Ing. W. Steiger, Volkswagen AG, Wolfsburg

### **Abridged version**

While today the emission of harmful substances plays an important role in the further development of power units, a reduction in CO<sub>2</sub> emissions will be of greater importance in the future. In no later than 20 years, however, the greatest priority will be placed on developing highly efficient drive systems as a result of depleting conventional energy sources as well as increased energy consumption throughout the world.

In this context, the hydrogen fuel cell drive systems are generally credited with the highest potential. Fuel cell powered vehicles already have outstanding exhaust emission properties, but at today's state of technological development with regards to CO<sub>2</sub> emissions and cost, these are inferior to DI diesel engines. The system needs to be greatly simplified and, more importantly, regenerative hydrogen must become a feature on the vehicle as a source of energy. A long wait is expected before this is made possible. Therefore, a transitional strategy is needed.

Volkswagen AG believes this can be achieved by consistent optimisation of conventional drive systems and their fuels. The direct injection diesel and petrol engines are the most frugal power units available today and this is unlikely to change if consideration is made to energy chains in general. However, restrictions are imposed on today's state of technological development with regards to exhaust emission levels. Fuel properties should play a significant role if further progress is to be made. With synthetically manufactured sulphur and aroma-free diesel and petrol fuel, not only are better raw emissions achievable but there are also great improvements to be made in the treatment of exhaust emissions. The future changeover to a regenerative primary energy source to manufacture these fuels will also be considerably easier as the quality and specific properties of the final fuel product will not depend on the primary energy source used.

### **Introduction**

From an environmental point of view, the development of vehicles and their drive systems will continue to be determined by consistently stricter emissions standards, which in California, for example, are practically at zero already even for conventional engines. Furthermore, measures to reduce consumption and to reduce CO<sub>2</sub> emissions also have a continually rising influence on the optimisation of vehicles and drive concepts. With the dramatic demise in the influence of vehicle emissions on the emissions situation and thereby also the air quality, the balance between the emission of classic harmful substances such as CO, HC and NO<sub>x</sub> and the emission of CO<sub>2</sub> will lend more towards the significance of CO<sub>2</sub>. This is mainly due to the fact that the greenhouse effect is now largely accepted as fact rather than fiction. Considerable pressure is being placed on the automobile industry as CO<sub>2</sub> emissions are set to rise until the year 2010 against the trend of the other harmful substances.

Seen globally, however, this plays a secondary role as the amount of CO<sub>2</sub> emissions is just 5.5% of the entire amount.

Another important aspect here is the increase in international demand for energy services at a time when the availability of valuable fossil primary energy sources is depleting - mineral oil in particular. Extreme concentration on petroleum as a primary energy source holds, above all else, considerable risks for the future. Therefore, a long-term, secure supply of energy sources for individual travel is dependent, especially in light of political instability in the countries of origin, not only on careful and minimal use of fuel, but mid-term and long-term diversification of the energy sources used to create fuel. The use of alternative and regenerative resources is thereby of particular significance.

The Volkswagen Group research department has the role of securing the technological basis for Volkswagen Group products long-term. The department is tasked with developing a strategy for the gradual transition from today's drive units and conventional, mineral oil-based fuels to future drive units and their associated fuels and primary energy sources. This strategy covers three areas

- Consistent further development of drive unit efficiency
- Use of alternative energy sources to produce fuel
- Development of CO<sub>2</sub>-neutral means of vehicle propulsion

In the area of reduced consumption, considerable success has already been achieved in the past. Compared with the different means of transportation, the newer cars can be regarded as wholly competitive. The 3L Lupo, equipped with the most modern technology for fuel efficiency, has proved itself as the most efficient means of local transportation. However, there is continued development to find even more efficient drive systems.

The highest degree of efficiency in a single power unit designed to propel a vehicle is found today in a hydrogen powered fuel cell. The prerequisite for this, however, is the availability of hydrogen. Hydrogen can only contribute towards a reduction in CO<sub>2</sub> emissions if it can be produced in a regenerative way. But there are three critical technological barriers that have to be overcome: There is currently no acceptable storage tank design for mobile customer use, there is no infrastructure nor is there economic technology for regenerative manufacture of hydrogen. Since there has so far been no technological approach to solve these three problems, hydrogen can only be viewed as a long-term solution.

The three important demands on fuel of the future

- Secure supply
- General economical compatibility
- Consideration of environmental and climate protection requirements

cannot be met today by one singular energy source.

This could result in the demand for a diversification of the fuels. Though at the same time, the market availability of diesel, petrol, methanol, ethanol, natural gas and other fuels cannot be deemed an economical solution as an individual drive system had to be developed for each of these fuels.

Therefore, research has to focus on finding a way of diversifying the primary energy sources and, at the same time, to concentrate this chosen energy source on mobile use.



In the next few years, greater emphasis will be placed on the use of natural gas in particular, which also has an advantage in the way of specific CO<sub>2</sub> emissions. Natural gas can and is used directly for vehicle propulsion. However, due to the known disadvantages in terms of range and space requirement for the tank, which applies for all gaseous fuels, natural gas cannot replace today's fuels, it can only supplement them. From natural gas, though, other secondary energy sources can be produced using common and large-scale tested procedures such as Shell Middle Distillate Synthesis (SMDS). To do this, natural gas is transformed in the first stage of the procedure by means of vapour reformation into a synthesis gas, which is a mixture of hydrogen, carbon monoxide and carbon dioxide. From this synthesis gas, a Fischer-Tropsch synthesis can be used to manufacture conventional fuel, high quality diesel fuel in particular, free of sulphur and aroma. This so-called 'Gas To Liquid' technology (GTL) is considered economical at today's crude oil price level in many areas of the world where cheap natural gas or natural gas derivatives are available. It is expected that another 5 to 8 years will pass until a stable and relevant supply of these synthetic fuels is made possible. This period is necessary for investments to be made and for the construction of synthesis production plants. This is viewed therefore as a short to mid-term solution.

These synthetic fuels have an enormous potential with regards to improving the engine-related combustion process. The properties of synthetic diesel fuel are impressive, especially the high cetane rating and the aroma and sulphur-free content. By using synthetic fuels in a diesel engine, NO<sub>x</sub> and particulate emissions are reduced at the same time. If the fuels were used in vehicles without adapting the calibration, as would be the case with diesel engines already on the market, no further measures would be required to meet the EU IV particulate limits on EU III vehicles. In a Golf with an 85kW PD diesel engine, particulate figures of below 0.008 g/km were measured in the NEFZ with oxygen added fuel.

The intermediate stage of synthesis gas now also allows the use of regenerative energy sources, such as waste wood, waste straw, energy plants or bio-waste and other waste products. The important factor here is that the quality of the end product, fuel, should not be dependent on the procurement of the primary energy source used. With this solution, the problem of availability and CO<sub>2</sub> emissions of the synthetic fuels is eliminated. The energy stored in the annual plant growth on this planet is approximately fifty times the energy used by man, i.e. an enormous replacement potential exists. The use of bio-mass also represents, from a political viewpoint, a relief in the energy supply sector because, compared with fossil energy sources, bio-mass is distributed evenly all over the planet. The CO<sub>2</sub> emission level does not fall to zero locally, but a CO<sub>2</sub> neutral cycle is created, which is the same as that of the sun. In this way, we can integrate the fuel cycle in the natural CO<sub>2</sub> cycle which includes approx. 98% of the total CO<sub>2</sub> emissions. In Germany and Europe, the bio-mass would be made available in three ways: from waste wood, waste straw and the cultivation of energy plants. In total, there is a potential of about 2280 TWh/a in convertible primary energy. While considering the energy of 50% required to produce the fuel, including transportation and processing waste, approx. 40% of today's fuel requirement could be covered in Europe and the member states. However, only 50% availability of fuel production can be used as a basis for planning because of the current availability of other stable paths of utilising bio-mass. In addition, consideration also has to be made to the fact that only approx. 70% of the trees grown for this purpose are actually felled. With this potential, another approx. 20% is available to cover the fuel requirements. A long-term figure of 30% to 40% of the entire fuel requirement appears to be realistic without including imported bio-mass in the equation.

Based on a medium transportation path of bio-mass over 50 km, an industrial plant size of 400 MW<sub>th</sub> can be realised with an output of approx. 3.200 bbl of fuel per day. This means that

approx. 550 such industrial plants would be necessary to cover 50% of the diesel used today in Europe and the member states. With 750 industrial plants, all of the bio-mass available in Europe could be processed as fuel. Normal production plants, e.g. for synthetic fuel, have a capacity of 80,000 bbl per day, that means 25 times more output than the production plant mentioned. For this reason, an industrial plant that has been optimised for reasons of efficiency would have, without doubt, an even higher output than 400 MW<sub>th</sub>.

The CarboV<sup>®</sup> process developed by Choren is a way of transforming bio-mass into a tar-free synthesis gas. To do this, the first stage involves gassing the bio-mass at low temperature to separate it into a gaseous and solid composition (bio-coke). In the second stage, the synthesis gas is then created. The waste product contains all the mineral elements of the plants that were assimilated during growth. The synthesis gas is then converted to fuel and hydrocrackers by means of a Fischer-Tropsch synthesis, for example.

This solution of a bio-mass based SunFuel can be viewed as mid-term as it is not yet economically compatible in today's terms. Compared with petroleum or natural gas based fuel (approx. 25 cent/litre), there is a loss in cost of approx. 25 cent/litre in the pure manufacturing costs before tax (based on above mentioned industrial plant size of 400 MW<sub>th</sub>). However, the manufacturing costs are far below those of today's filling station prices, which means that it is in the hands of the policy makers to introduce relevant taxation to promote these fuels until economical realisation is feasible.

Seen long-term, if cheap regenerative manufactured hydrogen were available, synthesis gas could be created from the CO<sub>2</sub> of combustion processes, for example from the smoke emitted by a power plant, and used to produce synthetic fuel. Such a process is also CO<sub>2</sub>-neutral as it does not lead to additional carbon dioxide emissions. Therefore, we call SynFuel produced in such a way "SunFuel".

## Fuel costs and CO<sub>2</sub> reduction potential

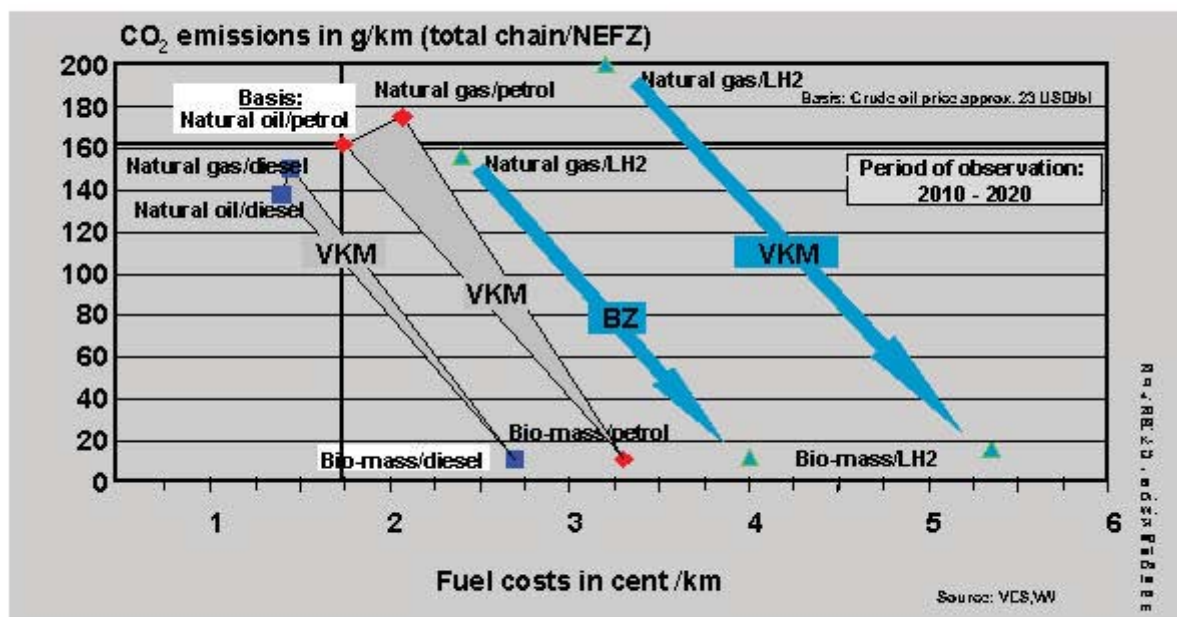

Group Research  
Energy conversion

VOLKSWAGEN AG

Figure 1: Fuel costs and CO<sub>2</sub> reduction potential

For an assessment of all these approaches, an all encompassing analysis of the energy chain is necessary in terms of energy consumption, CO<sub>2</sub> emissions and costs. Such an assessment is shown in **figure 1**.

The information with which the entire energy chain is assessed, i.e. the emissions including from fuel manufacture, shows that hydrogen powered vehicles have markedly higher CO<sub>2</sub> total emissions than a vehicle powered by a diesel engine if the hydrogen is manufactured from natural gas, as is currently the case, and if diesel fuel is manufactured from mineral oil. Even for a fuel cell drive system with hydrogen, the CO<sub>2</sub> emissions are higher than those of a diesel engine with conventional fuel made from petroleum and approximately at the same level as a diesel engine with fuel made synthetically from natural gas. Here, significantly higher costs have to be expected for hydrogen fuel than for diesel fuel. CO<sub>2</sub>-free hydrogen power systems are therefore dependent on the manufacture of hydrogen from regenerative energy, which results in considerably high costs, or from core energy. But other fuels can be manufactured and utilised if not CO<sub>2</sub>-free, at least CO<sub>2</sub> neutrally, e.g. SunFuel (diesel fuel made from bio-mass). Since considerably lower fuel costs would result here compared with hydrogen, a reduction in CO<sub>2</sub> via this path can be achieved at markedly reduced general economical costs. Another problem that stands in the way of general utilisation of hydrogen today is the unsatisfactory storage tank technology and the absent infrastructure.

Ideally, from a logistical point of view and to avoid additional economical costs, conventional fuels should be maintained also in the future because these can be manufactured both from fossil and alternative primary energy sources (bio-mass, etc.). Fuel cell powered drive systems can gradually supplement the combustion engine and later replace it. For the next 20 years at least, the consistent further development of conventional drive systems with combustion engines is the most effective solution in order to support a continual rise in efficiency and reduce CO<sub>2</sub> emissions caused by automobiles.

As the extraction of petroleum reaches its technical limit and the global energy requirement rises, alternative energy sources should quickly grow in importance in the future. At the same time, demand will rise on conventional fuels in terms of their quality and purity. The associated increase in costs generally acts in favour of more expensive alternatives. VOLKSWAGEN therefore anticipates a fuel evolution in the next few years that will begin with the conventional, petroleum based fuels and continue beyond natural gas type fuels to bio-mass based SunFuels. Not until the distant future, when all technological barriers have been overcome, will hydrogen take its place as an energy source for mobile application.

The availability of fluid hydrocarbons is also expected for the next 30 years. At the same time, synthetically manufactured fuels offer the means of optimal adaptation of the fuel properties to the combustion process. If thought is given to further reducing harmful substance emissions or to reducing the considerable effort needed for exhaust gas treatment, both will only be achievable if, above all, the NO<sub>x</sub> emissions from stratified combustion can be reduced. That means that NO<sub>x</sub> production must be suppressed during combustion without impairing the efficiency of the engine, thus quality control with direct injection (TDI or FSI) must be maintained.

To prevent the production of NO<sub>x</sub>, the temperature at which NO<sub>x</sub> is produced during combustion should not be exceeded, even locally. These local peaks in temperature can be prevented by means of a homogenous and part homogenous combustion process. To do this,

all or a large part of the fuel injected into the combustion chamber by fuel injection is transformed to vapour and mixed evenly with the intake air before the spread of the flame.

However, just by variation and adaptation of the remaining parameters, charge air volume, charge status (pressure, temperature, residual gas content) and charge air movement and turbulence, there is no way of achieving the necessary sustained reduction in NO<sub>x</sub> emissions (there are aspirations of reducing this by a factor of 15 ).

With the introduction of direct fuel injection for petrol engines too, both engine combustion concepts are becoming increasingly similar. The next stages of development in combustion technology will add weight to this trend. The described development of a “part homogenised diesel combustion process with/without external ignition” and also the “compression ignition petrol engine”, which is also a current development in the research and development laboratories, are already based on hardware that has a common core. Therefore, the main properties of both processes can only be brought together by developing a new combined combustion process. This is called CCS, Combined Combustion System, at Volkswagen.

The basis of this process is a new synthetic fuel. As far as today’s development is concerned (at the moment, the basic conditions are currently being established for such a process), basically the vaporising and ignition response, i.e. the composition, is of main interest.

In addition to mineral oil based fuels, synthetic conventional fuels will be introduced onto the market in this decade, mainly based on natural gas. For our customers (combined customer from the automobile and fuel industry) nothing will change with the introduction of synthetic fuels as all utilisation properties and the infrastructure will remain the same. The synthetic fuels are free of sulphur and aromas and, in their properties, can be tolerated to a greater degree than today’s fuels. These advantageous properties allow the automobile manufacturer to further develop his products with regards to lower fuel consumption and on diesel engines, in particular, to further improve emissions.

# Halogen-free Flame Retardants in Polymers

Manfred Doering, Carsten Kollann, Michael Ciesielski  
Institute for Technical Chemistry, Forschungszentrum Karlsruhe GmbH,  
P. O. Box 3640, 76021 Karlsruhe, Germany, [manfred.doering@itc-cpv.fzk.de](mailto:manfred.doering@itc-cpv.fzk.de)

## Introduction

Our environment is largely one of polymers and all polymers are combustible materials whether natural or synthetic. Flame retardancy of polymers has been achieved by adding halogenated compounds, often in combination with antimony oxide. However, polymers containing that type of protection will generate toxic and corrosive fumes <sup>[1]</sup> during thermal decomposition. This way of interrupting the flame cycle is a *vapor phase inhibition* based on the formation of hydrogenhalides as free radical inhibitors. The formation of hydrogenhalides stands both for a serious health hazard and a difficult recycling- and waste removal processing.

Phosphorylation, in recent years, is considered to be one of the most efficient means of conferring flame retardancy on polymeric systems. High flame retardant efficiency, less production of corrosive and toxic gases in flames, and less environmental pollution are the noteworthy benefits of replacing halogens with phosphorus in flame retardants. A phosphorus content of about 1 – 6 % in the polymeric material interrupts the flame cycle in the *solid phase*. Phosphorus promotes extensive polymer crosslinking at the surface, forming a carbonaceous char upon heating and stabilizing the char with poly- and metaphosphoric acids. Char insulates the underlying polymer from the heat of the flame, preventing production of new fuel and further burning (Fig. 1).

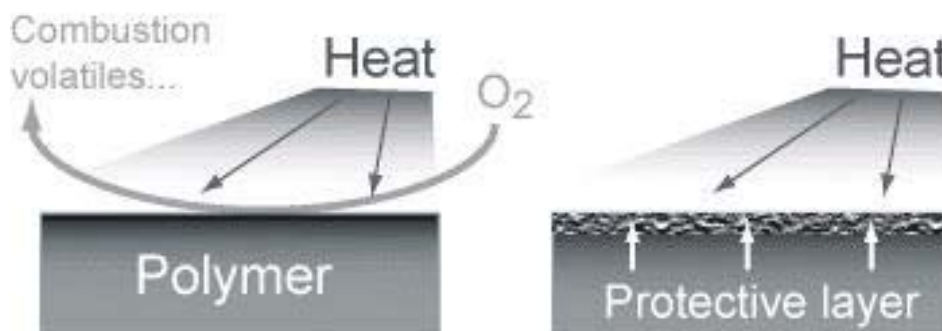

Fig. 1

## Organophosphorus Compounds as Flame Retardants

The required amount of phosphorus in the polymer can be achieved by blending the polymer with a phosphorus-containing additive or by incorporating a covalent bonded organophosphorus moiety into the polymeric backbone. Additives are in most cases easier to make and they can be used for several types of polymers. The disadvantages of additives are a significant deterioration of mechanic properties and possible „bleeding“. Reactive-type flame retardants overcome these drawbacks, because the flame retardant function becomes an

integral part of the polymeric network. This method is generally preferred when excellent mechanic properties are desired or a good chemical resistance of the fire protection against permanent impact of water or organic solvents is required. The use of a certain reactive flame retardant is often restricted to one kind of polymer and the production costs are usually higher than in the case of an additive. This led to a renaissance of research in the field of organophosphorus compounds. The major target is the development of a class of substances, suitable for several different types of polymers, deriving from one parent compound.

9,10-Dihydro-oxa-10-phosphaphenanthrene-10-oxide (DOP), is a bulk chemical manufactured by Schill + Seilacher AG and Sanko Chemical Co., that has proven to be a good flame retardant additive.<sup>[2]</sup> Based upon this substance the synthesis of alkyl-, allyl-, alkoxy-, glycidyl- and hydroxyl-functionalized compounds is presented. Keystep is the reaction of the less-reactive but acidic DOP with orthoformates in the presence of an acid catalyst to form the neutral and reactive esters DOPAL3<sup>[3]</sup>. The described synthesis (Fig. 2) avoids the use of halogenated intermediates and is suitable for industrial scale up.

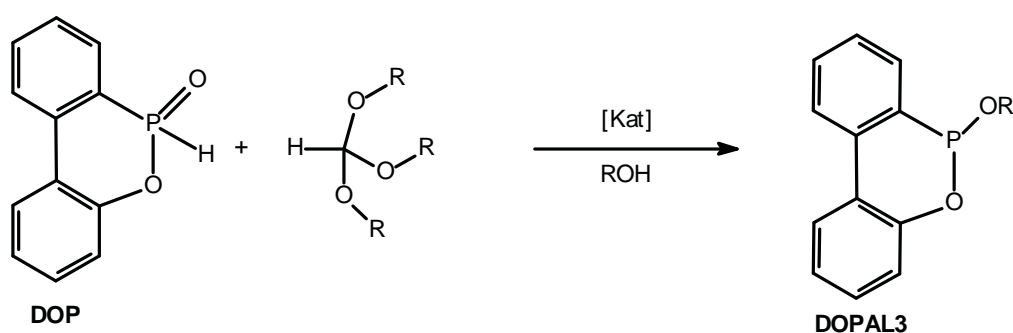

Fig. 2

DOPAL3 (R = Me or Et) is a reactive and efficient flame retardant for Polyamide 12; PA 12 containing maximum 10 % of DOPAL3 achieves V-0 rating (UL-94 test). The mechanic properties of DOPAL3-protected PA 12 are superior to those of the pure polymer, a sharp contrast to usual effects of an additive. DOP itself can not be used for polyamides, because it cleaves the polymeric chains when blended with the polymer in a kneader at elevated temperatures. Furthermore DOPAL3 is a versatile intermediate, which leads to a number of flame retardants both additive and reactive (Fig.3).

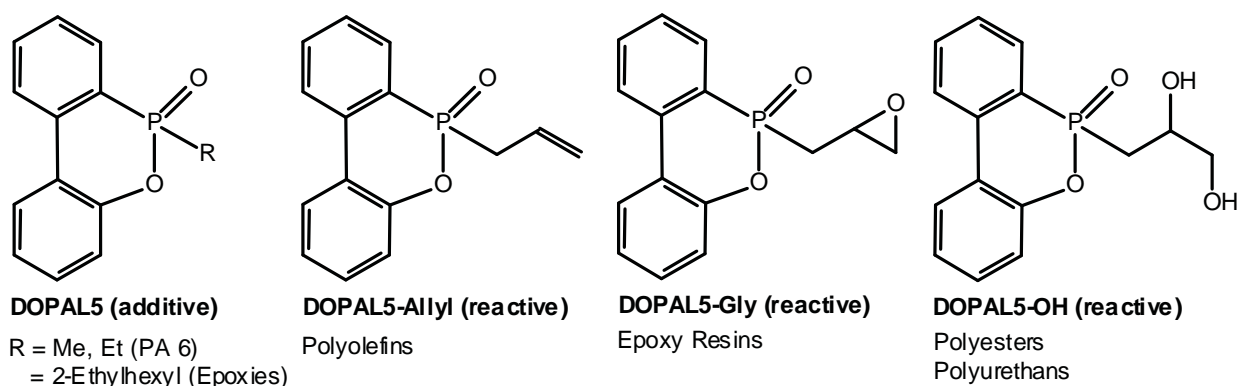

Fig. 3

The compounds shown in Fig. 3 are obtained in high yields via simple standard reactions with commercially available substrates. The additives DOPAL5 are thermally very stable; DOPAL5 (R = Ethyl) is a solid (mp. 102 °C) and one of the very few organophosphorus compounds, which can be blended with Polyamide 6, a procedure that requires temperatures above 300 °C. The 2-ethylhexyl-derivative of DOPAL5 is an oil at ambient temperature and exhibits an excellent miscibility as well as a very low vapor pressure. DOPAL5-Allyl is a possible co-monomer for fire protected polystyrene or polymethylmethacrylate. DOPAL5-Gly has already been successfully tested for carbonfiber/epoxy-laminates. Due to the monofunctional nature of that substance, it can not be used in high proportions, otherwise the threedimensional network of the resin is weakened. The synthesis of a bisepoxy-derivative based upon DOP, that provides the good flame retardency of DOPAL5-Gly, together with enhanced mechanic properties, is actually in progress. The dihydroxy-derivative DOPAL5-OH is mainly designed for polyesters, a material which is important for fire-protected textiles.

## Literature

- [1] R. Dumler, H. Thoma, *Chemosphere* **1989**, *19*, 305.
- [2] H. Lengsfeld, V. Altstaedt, S. Sprenger, R. Utz, *Kunststoffe* **2001**, *91*, 94.
- [3] M. Ciesielski, M. Doering, C. Kollann, S. Sprenger, DE 10206982, patent pending **2002**.

# **Recycling soft PVC and technical polymers from electronic waste while eliminating used additives and PBDD/F**

Dr. Andreas Mäurer, Udo Knauf, Martin Schlummer  
Fraunhofer-Institute for Process Engineering and Packaging,  
Giggenhauser Str. 35, 85354 Freising, Germany

## **Abstract**

This paper describes two examples of our applied research for polymer-recycling. Principally we strive for developing an economic process with high purification-efficiency, so that high-quality recyclates can be achieved out of mixed and contaminated plastic-waste. For the process development we combine stepwise process engineering and analytical evaluation of optimisation-steps.

The main development-task is to clean up the polymeric macromolecules by removing the quality-interfering substances and by conserving the primary morphology and functionality of the polymers. Both examples were topics in a public financed project (BayFORREST) starting in 1998 together with Prof. A. Kettrup, TU München/GSF Oberschleißheim and Dr. H. Utschick, TA Instruments, Alzenau.

Part 1 deals with the process development for PVC-recyclates from floor coverings and part 2 presents the transferability of the recycling process to ABS and polystyrene-copolymer-recyclates out of mixed contaminated post-consumer electronic-waste.

## **Part 1: Recycling of soft-PVC**

### **Introduction**

In Western Europe, polyvinyl chloride (PVC) is the second most important plastic in quantity terms. It is principally used in the construction industry. For some of the large-volume PVC articles used in the construction sector, material recycling methods are established. These large-volume PVC articles, especially components for windows and piping, are largely made from hard-PVC. However, due to dehydrochlorination during thermal processing, the recycling of these materials has to care about "down-cycling".

Within the framework of the above mentioned project, a new method for producing recycled materials from the following PVC articles is being investigated:

- articles from soft-PVC or
- waste constituents or
- residual waste from existing material recycling methods.

The recycled materials must have proven and acceptable characteristics for their end-use. This so promotes the multiple usage of raw materials and helps towards achieving industrial recycling goals.

Soft-PVC, especially that from floor coverings, is a favoured raw material for recycling due to the fact that there is already an established functioning logistics system for obtaining sufficient quantities of material in sufficiently well-sorted forms (collection from specialist shops and workshops, collection via an established industrial group working on recycling of PVC floor coverings). Besides the economic significance here, the recycling of PVC material is an ideal model system for high additivated plastics. Recycling methods for such systems using dissolution are currently assuming high importance.



## Methods and Material

In order to refine the plastic, the first step is to dissolve the PVC-plastic matrix in a suitable solvent (e.g. THF). Factors such as the polarity of the solvent, pH value, temperature etc. have to be clearly defined for the dissolution process. Once dissolved, the plastic polymer is in the form of individual macromolecules and it is because of this that the method has high purification potential. It is possible to eliminate unwanted externally-adherent materials and, unlike methods employing melt technologies, unwanted/interfering materials that were within the original plastic matrix. The latter can be additives or substances which have migrated there during usage or during the preparation. The interfering substances can be categorized into groups according to their interfering effects:

- those with toxicological effects (polyaromatic hydrocarbons, polychlorinated aromatics, heavy metals)
- those causing interference to processing (low molecular polymer fractions, radicals, crosslinking agents, causing changes in rheology properties or leading to crosslinking)
- those causing optical effects (coloured materials, oxidants)

After the dissolution step, interfering substances are removed from the solution by a combination of separation methods. The precipitation step can then be carried out on a purified polymer solution.

Based on current knowledge and technology regarding solvent-based recycling methods, the aims of the project were

- to formulate a process concept based on the schematic diagram below,
- to draw up technical equipment specifications and
- to set up and test a continuous process line (throughput 20 kg per day) at the Fraunhofer-IVV.

This will give the necessary technical process engineering data for scale-up to pilot-plant quantities (300 tones per year). Using product samples we looked for dependencies on the properties of the recycled material (mainly relating to application technologies and the amounts of interfering substances in the recycled materials) and the processing steps.

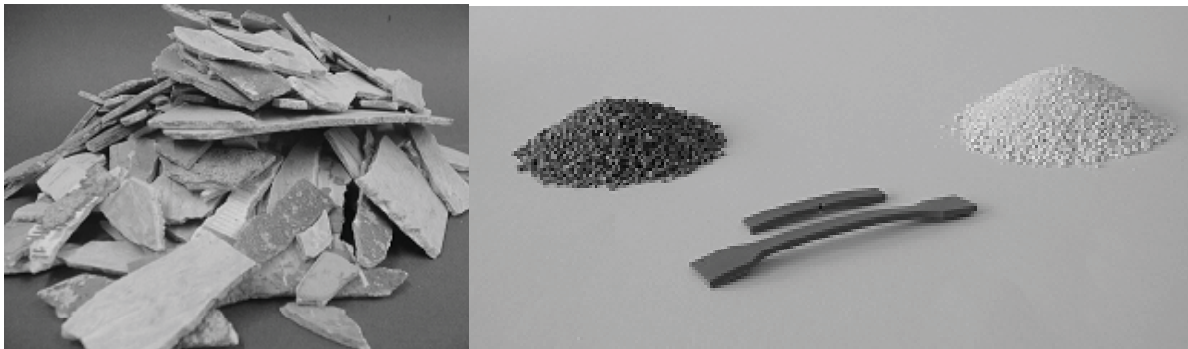
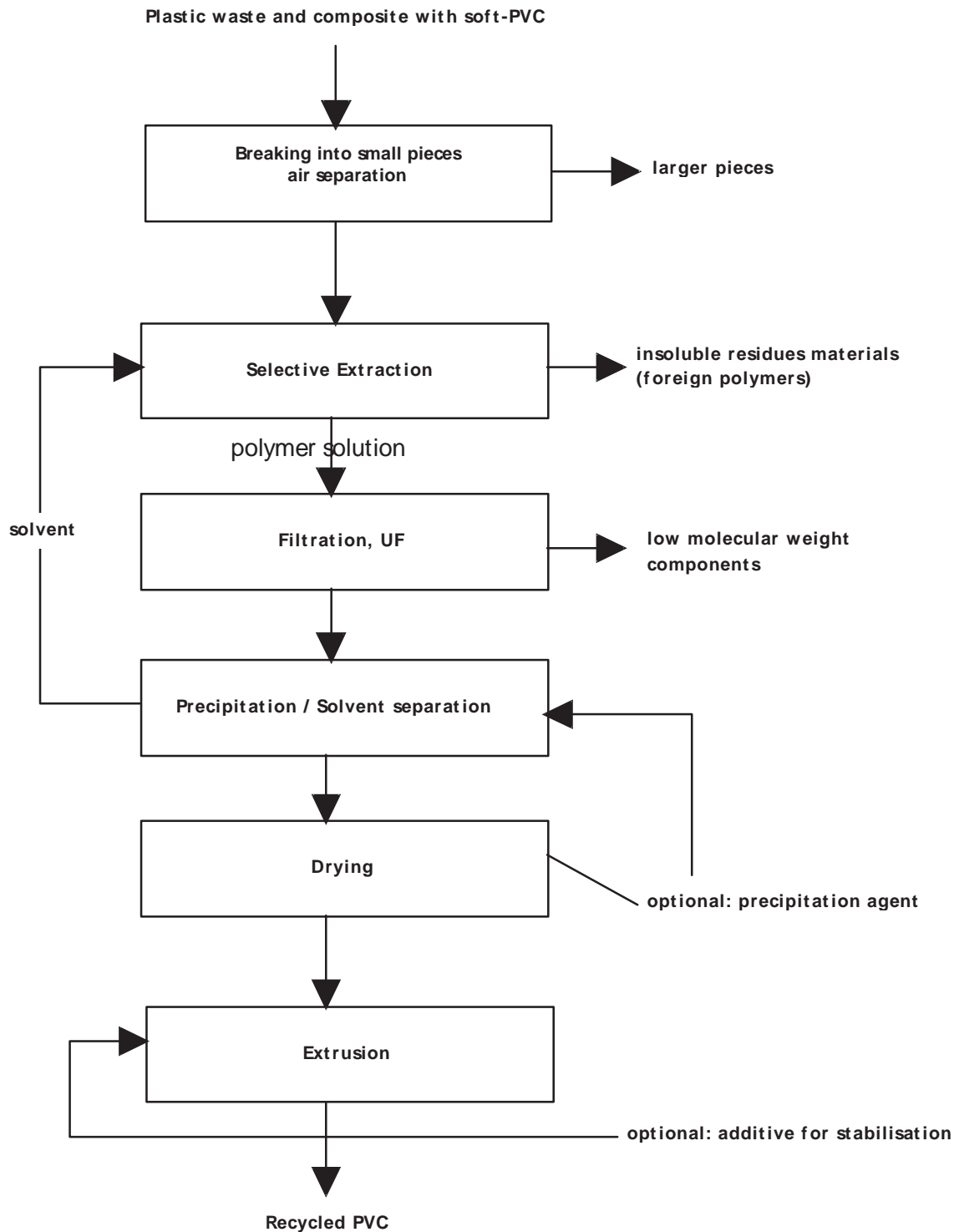

Figure 1: Waste-input and product-samples of the recycling process



**Figure 2: Method for recycling PVC using the Selective Extraction concept**

For characterisation of the input waste-material and of the product-samples (post-consumer waste of floor covering and recyclate-powder, granules, test-bars; ref. fig. 1) thermoanalytical methods (TG/MS, DTA) were applied successfully. This information allow the process steps to be optimized and finally lead to the implementation of a small pilot-plant.

## Results and discussion

The applied thermoanalytical methods lead to important results concerning PVC-quality, content of residual solvent and elimination of fillers and interfering substances:

By means of high resolution thermogravimetry the stepwise thermal degradation of soft-PVC can be observed (figure 3). The results are in good correlation to published data<sup>1-6</sup>.

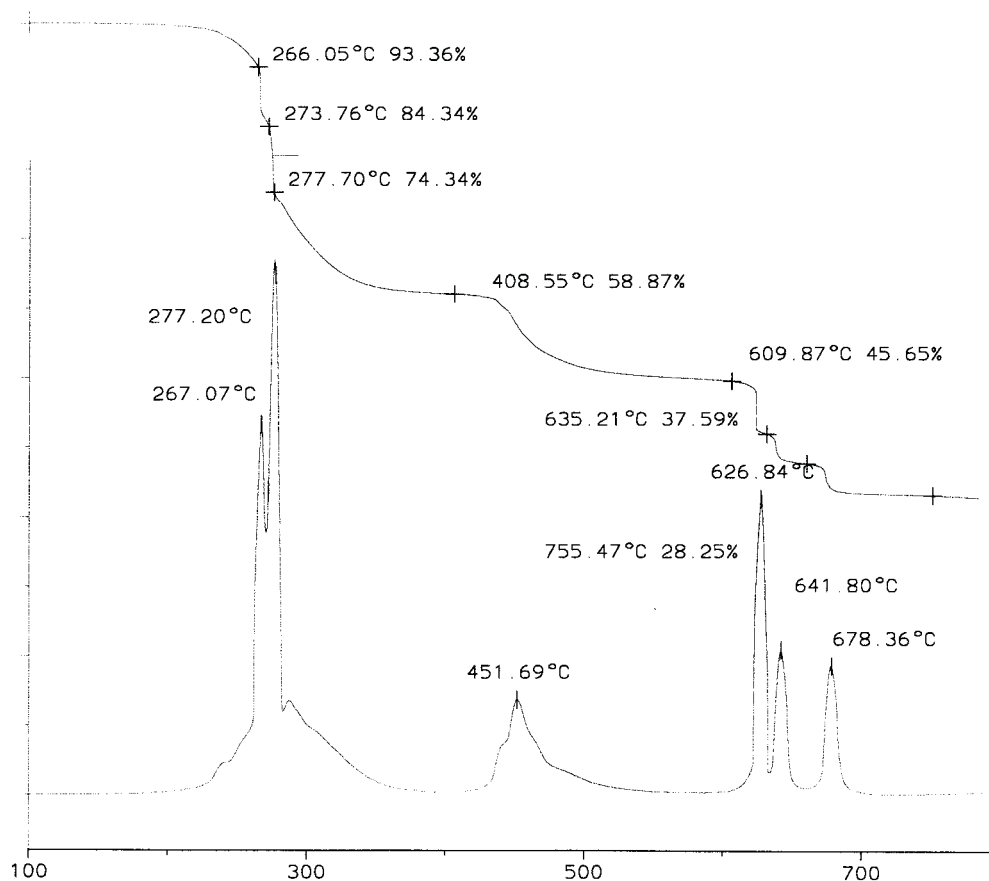

**Figure 3: High resolution thermogravimetry of soft-PVC**

The DSC-results characterise the product-samples relating to residual solvent-content and they distinguish between free and included solvents (figure 4).

The thermal degradation of rigid- and soft-PVC (high content of additives) distinguish benzyl- and tropyliumfragments in relation to the alkylfragments of the aliphatic groups from plasticiser and thermal stabiliser (figure 5).

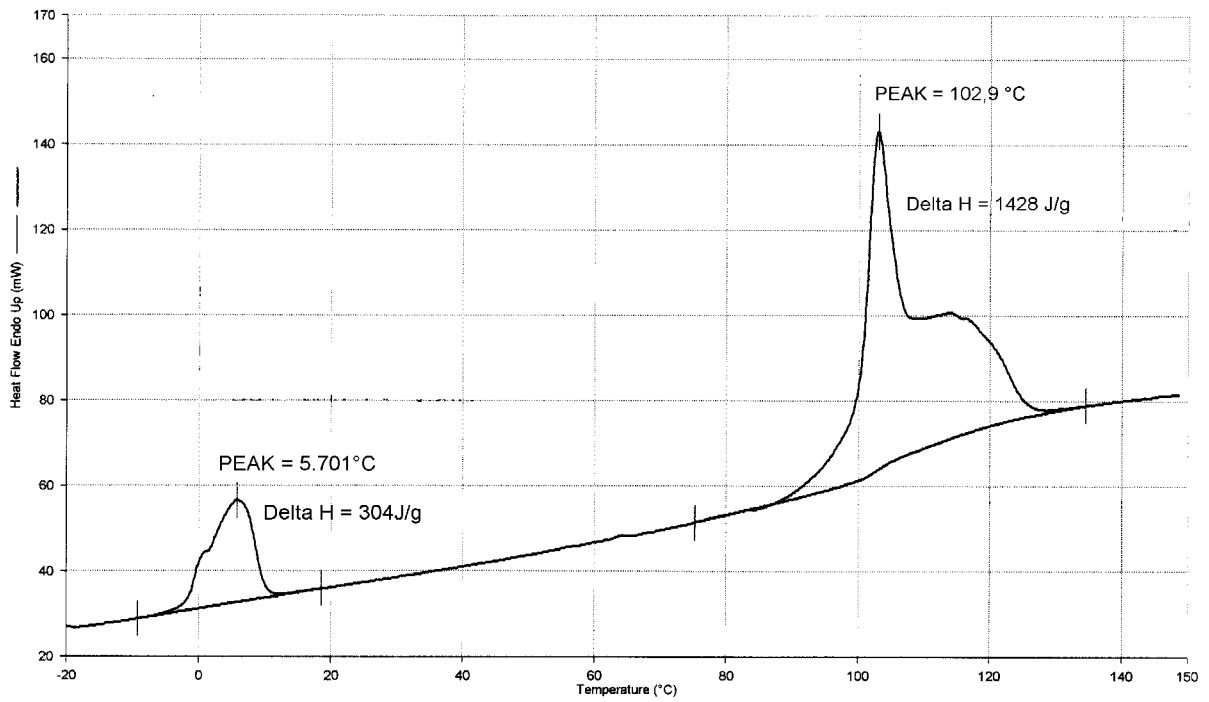

Figure 4: DSC-results of PVC-recyclat

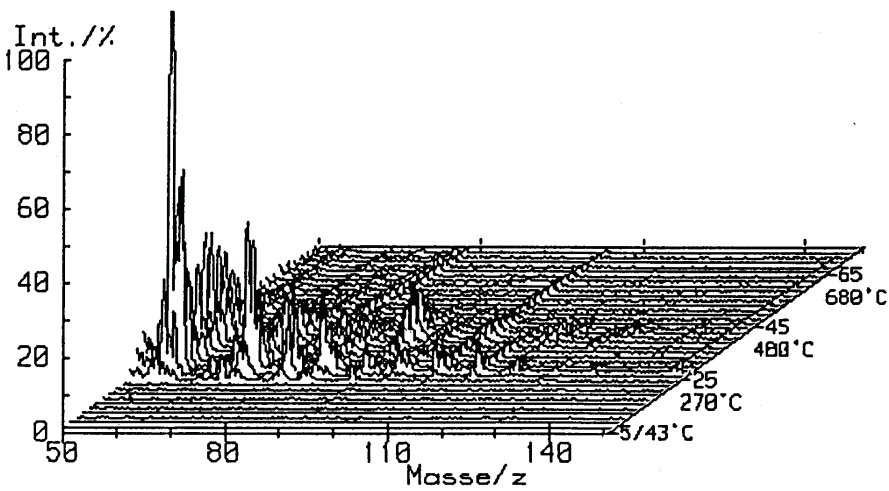
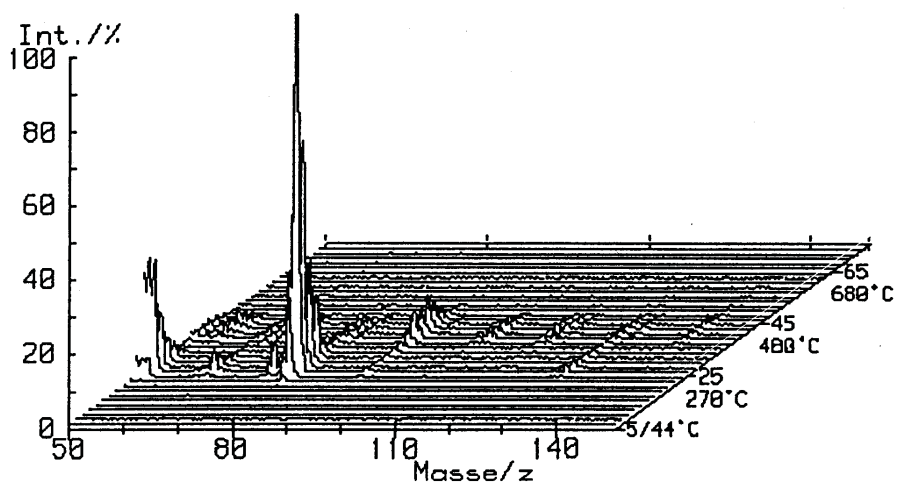

Figure 5: Coupled thermogravimetry/mass spectrometry of rigid and soft-PVC

The characterisation of PVC is chiefly concerned with the following aspects:

- the determination of the glass transition temperature as a characteristic parameter for the processing and application, or for the degree of softening;
- the thermal stability and hence the effect of the added thermal stabilisers;
- knowledge about the thermal decomposition of the plastic against the background of environmental-political concerns and for preventing danger when waste is disposed of by thermal means.

Numerous authors <sup>1-7</sup> have addressed the thermal decomposition of PVC. All conclusions stated that PVC decomposes in two stages. In the first stage, there is sequential dehydrochlorination and splitting-off of aromatic compounds. The later is the decomposition of the residual polymer chain (and the additives).

Based on all these analytical data the process scheme was brought forward to a continuously running small technical plant with a capacity of 25 kg polymer recycle per day (figure 6).

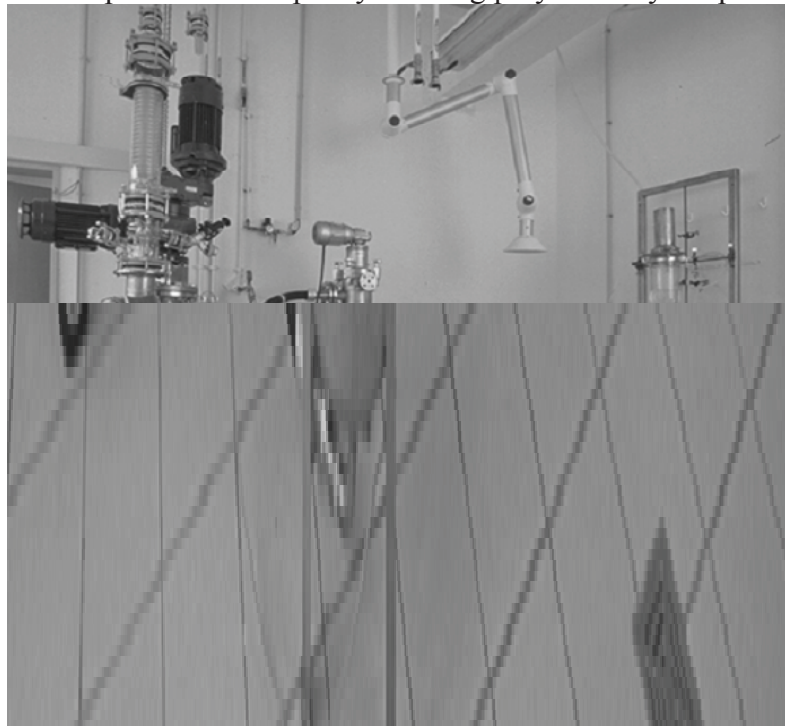

**Figure 6: Parts of the small technical pilot plant for polymer recycling at Fraunhofer-IVV**

The produced recyclates were processed to test barrs and the mechanical and application data evaluated (table 1):

<b>specifications</b>	<b>PVC-recyclate</b>	<b>virgin-PVC<sup>3)</sup></b>
notched impact strength Charpy [mJ/mm <sup>2</sup> ]	119	>30
tensile strength [MPa]	24	26-30
elongation at break [%]	98 <sup>1)</sup>	>170 <sup>2)</sup>
hardness Shore D (DIN 53505)	58	40-60
k-value	67,2	60-70
glas transition temp. [°C]	105	50-80

<sup>1)</sup> speed of tensile test: 100 mm/min

<sup>2)</sup> speed of tensile test: 50 mm/min

<sup>3)</sup> data from Saechtling Kunststoffaschenbuch, 24. Ausgabe, Carl Hanser Verlag, München 1989 und B. Carlowitz: Kunststoff Tabellen, 4. Auflage, Carl Hanser Verlag, München, 1995

**Table 1: Mechanical and thermal data of recyclat compared to virgin PVC**

Due to the high purification potential of this recycling method, the data correspond very nice to the original ones and it is possible to use the recycled products in an array of applications, including their original use.

The analytical data proved the elimination rates of heavy metals, polychlorinated dibenzodioxine and furanes above 98 %. The recycle is in compliance with all relating thresholds regulated by law.

Based on the experimental measured mass balances and energy flows the energy demand and the conversion costs of an industrial plant were calculated. We are striving to find economically attractive markets for the recycled PVC products and are drawing up recommendations for the new materials and carrying out technical application tests. We hope that, at least in part, the use of virgin materials for PVC products can be replaced with our recycled materials.

## References

- [1] S.A. Liebmann, D.H. Ahlstrom, C.R. Foltz: Journal of Polymer Science: Polymer Chemistry Edition Vol. 16, 3139 – 3150 (1978)
- [2] J. Behnisch, H. Zimmermann: Intern. J. Polymeric Mater. 1992, Vol. 16, 143 – 157
- [3] W. Tötsch: Nachr. Chem. Tech. Lab. 40 (1992) 6, 715 – 722
- [4] H. Bockhorn, R. Krümann: VDI-Bericht Nr. 1090 (1993)
- [5] H. Utschick, M. Ritz, H.-J. Mallon, M. Arnold, W. Ludwig, A. Kettrup, G. Matuschek, J. Cyris: Themochimica Acta 234 (1994) 139 – 151
- [6] K. Heldt, H. Utschick, A. Mäurer, M. Wiese: Vortrag anl. der 13. Ulm-Freiburger Kalorimetrietage 1999
- [7] W. Holley, T. Luck, A. Mäurer, U. Knauf, H. Utschick, C. Namendorf: Journal of Thermal Analysis, Vol. 52 (1998) 221-233.

## Part 2: Recycling of ABS and HIPS

### Introduction

In the past decades special polymer parts of electronic articles were equipped with brominated flame retardants including polybrominated biphenyls (PBB) and polybrominated diphenyl ethers (PBDE). After PBB and PBDE have been recognised as a possible source of polybrominated dioxins and furans (PBDD/F)<sup>8,9</sup>, producers of electronic equipment started to fade out the use of these flame retardants.

However, due to the expanded life time of at least some electronic articles, polymers in today's electronic waste may still contain PBB and PBDE but also PBDD/F in the ppb range<sup>10</sup>. Besides technical problems it is mainly the probable existence of high PBDD/F levels in electronic waste polymers which hinders any mechanical recycling approaches to treat this waste fraction<sup>11</sup>, even if waste amounts and polymer properties would favour a recycling from the economic point of view.

A new solvent based polymer recycling process developed in our institute might serve as a solution to this problem<sup>12</sup>. The technique involves a dissolution step in which polymer containing waste fractions are dissolved, a cleaning step and a precipitation of the polymers by adding a different agent. Finally, the precipitated polymer is dried and regranulated (Fig. 7). Treating PVC and ABS polymer fractions the general ability of this process has been demonstrated to substantially eliminate additives and contaminants from the polymer phase including phthalates and PBDD/F (refer to part 1).

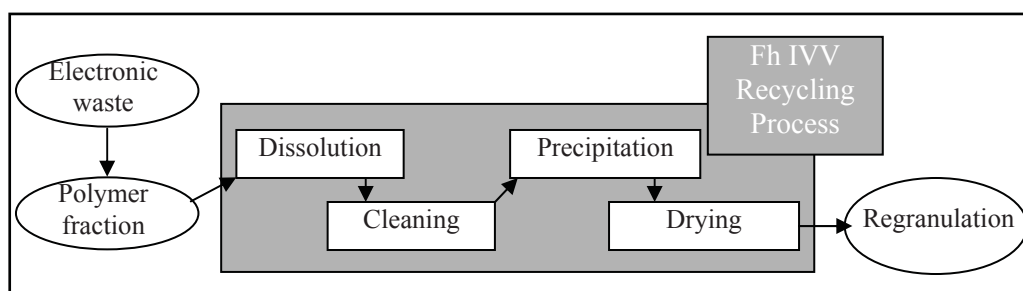

**Figure 7: Recycling of polymers from electronic waste with the Fraunhofer-IVV process**

In order to further optimise the reduction potential and to adjust the single process steps to the polymer types present in electronic waste plastic fractions we built up the following project cluster:

1. Screening of typical waste fractions for polymer types and levels of PBDD/F and flame retardants
2. Process optimisation driven by polymer types to handle and mass balances for brominated flame retardants and PBDD/F
3. Tests of different toxic waste treatment approaches to decontaminate the separated waste fraction containing brominated flame retardants and PBDD/F
4. Development of analytical tools for an efficient and inexpensive quality assurance

Here we present the results of the projects 1 and 2 focussing on waste fractions containing high amounts of TV set and monitor housings gained from a local disassembling plant. It should be stated that the mass balance results shown summarise the reduction potential of the initial state of the Fraunhofer-IVV recycling process. All future process optimisation approaches will be mass balanced and compared with this initial state.

### Methods and Material

Characterisation of waste input, intermediate products and regranulated samples

*FT-IR:* Types of polymers and polymer blends were identified in ground samples by Fourier transform infrared spectroscopy applying the *golden gate* technique.

*X-ray fluorescence analysis:* The existence of brominated flame retardants was screened via bromine determination with energy dispersive x-ray fluorescence analysis (EDXRF). Since the surfaces of the samples potentially affect the precision of the results and since they were quite different for the investigated materials, the samples were dissolved in suitable solvents and the solution were analysed for bromine.

*Determination of PBDD/F and brominated flame retardants:* To characterise input materials, intermediates (dried precipitates) and products (regranulates) of the process the representative samples were spiked with  $^{13}\text{C}$ -PBDD/F standards and extracted with cyclohexane by accelerated solvent extraction. The extracts were gravimetrically divided in a flame retardants fraction and a PBDD/F fraction. The first fraction was diluted to concentrations of about 50 ppm, and analysed for decabromodiphenyl ether (DeBDE), octabromodiphenyl ether (OcBDE), tetrabromobisphenole A (TBBP A), 1,2-bis-tribromophenoxyethan (TBPA), resorcinol-diphenylphosphat (RDP) and triaryl phosphates (TAP) by HPLC-UV/MS. Method details are described elsewhere<sup>13</sup>.

The PBDD/F fraction was treated with a four column clean-up using acid/basic silica, alumina oxide and two times florisil. The second florisil column was necessary to eliminate residual flame retardants which might disturb the analysis of polybrominated furans. After clean-up the samples were analysed by GC-HRMS (MAT 90, ThermoFinnigan) and quantified using an isotope dilution method.

## Mass balance approach

*Lab scale recycling unit:* The lab scale recycling unit consists of a stirred 10 litre solving reactor, a filtration unit, a precipitation unit and a ventilated oven.

*Processes tested:* According to the process outlined in fig. 7, the input materials were dissolved, sieved and precipitated. The fine precipitated polymer was washed with fresh solvent twice before it was dried at temperatures below 100°C. The resulting dried powder (intermediate) was finally regranulated by laboratory scale extrusion (Fa. Haake). The maximum extrusion temperature was 240°C to simulate a worst case extrusion.

*Materials tested:* 7 Samples containing different types and amounts of polymers and flame retardants were submitted to the Fraunhofer-IVV process (table 2). The column "FR present" indicates flame retardants identified in the polymers used, "FR added" refers to flame retardants the polymers were fortified with. Input materials C to G were contaminated with PBDD/Fs produced by thermolytic degradation of technical octabromodiphenylether at 600°C for 7 minutes and with a FR mixture of DeBDE, OcBDE, TBPE and TBBPA.

No	polymers / polymer blends	FR present	FR added	addition of PBDD/F
A	ABS	OcBDE, TBBPA	none	none
B	HIPS	DeBDE	none	none
C	ABS	OcBDE, TBBPA	FR mixture	yes
D	HIPS	DeBDE	FR mixture	yes
E	monitor shredder	n.d.	FR mixture	yes
F	disassembling plant shredder	n.d.	FR mixture	yes
G	ABS, HIPS, PPO/PS, ABS/PC	none	FR mixture	yes

**Table 2: Samples subjected to the lab scale process**

## Results and Discussion

Results of the material screening of 34 TV set and monitor housings are displayed in fig. 8 indicating a dominance of HIPS and ABS in these waste fractions. The frequency of brominated flame retardants which have been shown to produce PBDD/F during extrusion (DeBDE, OcBDE and TBPE)<sup>10</sup> accounts for 40% in the materials tested so far (fig 9) and hints to the increased caution these waste materials have to be handled with.

polymer / polymer blend	frequency (n=34)
ABS	24 %
ABS/PC	9 %
ABS/PVC	9 %
HIPS	34 %
PPO/PS	24 %

**Fig. 8: Polymers/polymer blends identified**

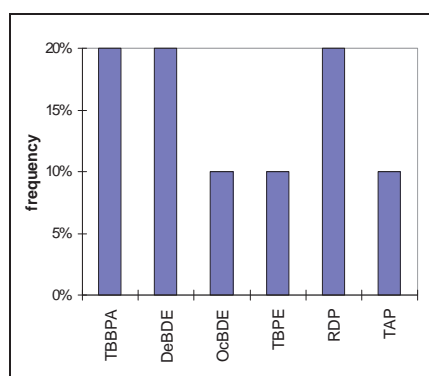

**Fig 9: Flame retardants identified**

Fig. 10 gives a typical congener pattern of tetra- to hexabrominated PBDD/Fs determined in a typical ABS monitor housing containing OcBDE (sample A). According to the German "Chemikalienverbotsverordnung" this material has to be excluded from common mechanical recycling processes. However, applying the FhIVV recycling process could significantly reduce the levels of bromine, TBBPA and PBDD/F in the samples A-G (see figures 11-13) even if the process has not been optimised yet. In future the reduction potential will be increased by improving the cleaning and the precipitation step.



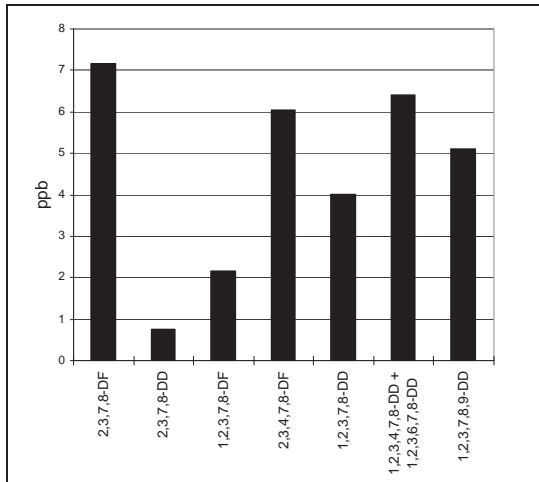

Fig 10: PBDD/F in an ABS/OcBDE monitor housing

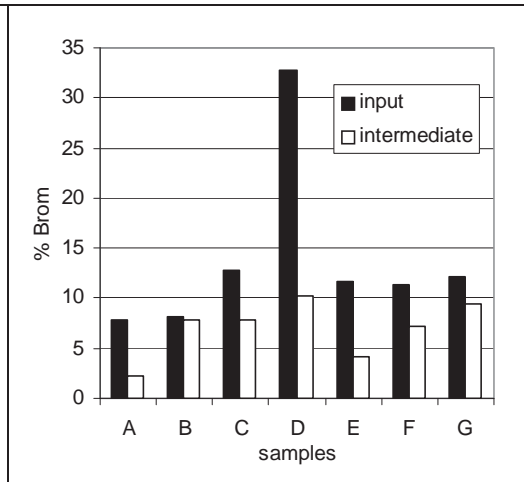

Fig 11: Bromine reduction obtained during the Fraunhofer-IVV recycling process.

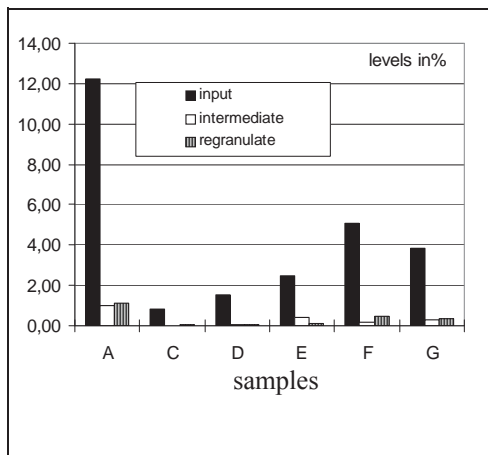

Fig 12: TBBP A reduction obtained during the Fraunhofer-IVV recycling process.

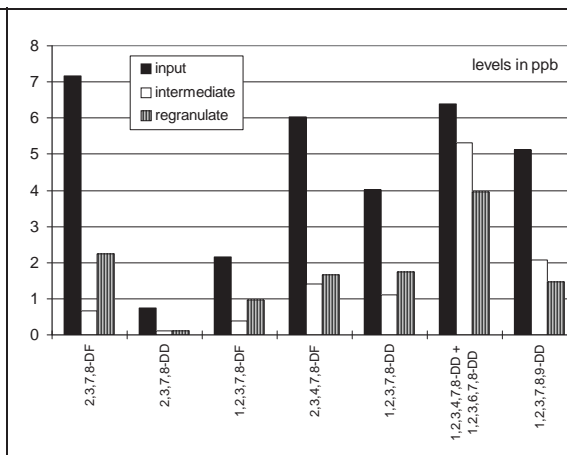

Fig 12: PBDD/F reduction obtained during the Fraunhofer-IVV recycling process.

## References

- [8] Donnelly JR, Grange AH, Nunn, NJ, Sovocool G, Brumley WC Mitchum RK (1989) Biomed. Environ. Mass Spectrom, 884.
- [9] Brenner K, Knies H (1990) Organohalogen Compounds 2, 319.
- [10] Riess M, Ernst T, Popp R, Müller B, Thoma H, Vierle O, Wolf M, van Eldik R (2000) Chemosphere 40, 937.
- [11] Meyer H, Neupert M, Pump W, Willenberg B (1993) Kunststoffe 83, 253.
- [12] Knauf U, Mahlberg A (2000) Final report, BayForrest Research Project F161.
- [13] Schlummer M, Brandl F, Mäurer A, Luck T (2001) Müllmagazin 3, 39.

## Acknowledgement

We greatly appreciate the financial support of the presented BayFORREST-project given by the "Bayerisches Staatsministerium für Landesentwicklung und Umweltfragen".

# Energy and material recovery by co-combustion of WEEE and MSW

Juergen Vehlow, Frank E. Mark

## Introduction

During the last years waste from electrical and electronic equipment (WEEE) has become a material of concern on many levels, first of all on the political one. Its generation increases. The material becomes more and more complex and so does its disposal. Polymers of various types, approx. 11 % of which are actually flame retarded by brominated organic compounds, contribute a mayor fraction to this waste stream and make, in combination with metals and composites, material recycling rather difficult. Especially for plastic waste from old equipment there is a risk that it may contain polybrominated dibenzo-p-dioxins (PBDD) and dibenzofurans (PBDF) from the compounding of meanwhile phased out flame retardant formulations. Such contaminants are prohibitive for bringing these materials back into the economic loop.

Suitable disposal options are thermal recycling by e.g. staged pyrolysis [Hornung et al. 2002] or thermal treatment by combustion. The latter strategy implies the chance to combine an efficient inertisation of the organic matter with the recovery not only of energy but also of bromine and eventually heavy metals.

Two test campaigns on co-combustion of WEEE together with municipal solid waste (MSW) in a pilot plant for waste incineration have been performed by Forschungszentrum Karlsruhe and co-sponsored by APME (Association of Plastic Manufacturers in Europe) and partly by EBFRIIP (European Brominated Flame Retardants Industry Panel). Major objectives of the program were

- the potential influence of flame retarded plastics on combustion control and burnout quality,
- the thermal stability of flame retardants and PBDD/F,
- the fate of bromine and its speciation in the gas phase,
- the effect of bromine on the volatilisation of heavy metals, and
- the potential of formation of mixed halogenated dibenzo-p-dioxins (PXDD) and dibenzofurans (PXDF).

The results of these test campaigns will be reported here.

## TAMARA pilot plant for waste incineration

The tests took place in the Karlsruhe TAMARA pilot plant for waste incineration on the grate, a mass burner with a nominal throughput of 200 - 250 kg/h of preconditioned waste. A schematic drawing of its combustion chamber and heat boiler is shown in Fig. 1. The design of the combustion chamber can be changed from the original counter current to parallel flow geometry by the installation of variable roof elements. All test trials were conducted using the central flow configuration which is depicted in the scheme.

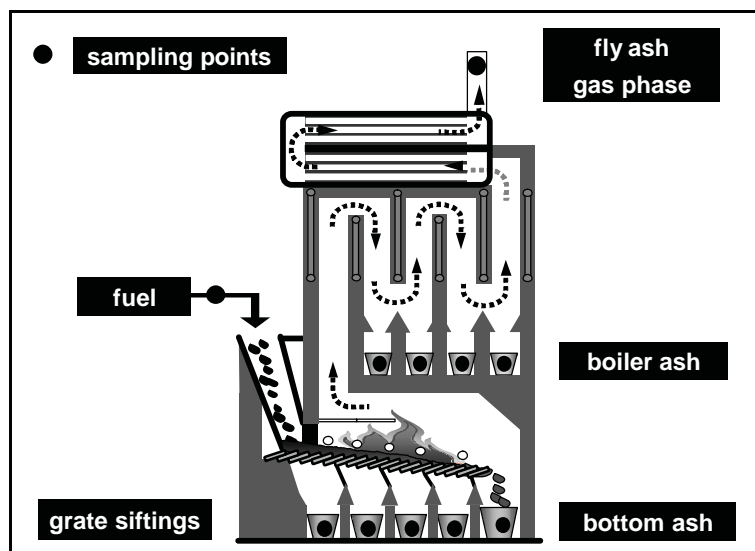

**Fig. 1** Scheme of the TAMARA furnace with sampling points

The air pollution control system comprises a fabric filter which is operated at approx. 180 °C and a two-stage wet scrubbing system with a separate quencher. A pH regime of 1 or lower is established in the first scrubber to remove HCl, HBr, HF and especially Hg from the flue gases. The second scrubber is adjusted to a pH of approx. 7, mainly to absorb SO<sub>2</sub>. In case of elementary Br<sub>2</sub> in the raw gas, sodium thiosulphate was added to this scrubber for reduction and absorption of the resulting bromides. A scheme of this part of the gas cleaning is shown in Fig. 2. For compliance with the German emission standards for PCDD/F and Hg a fixed bed coal adsorber is installed directly downstream of the scrubbing system. The reduction of NO<sub>x</sub> is performed by SCR at the back end of the air pollution control system.

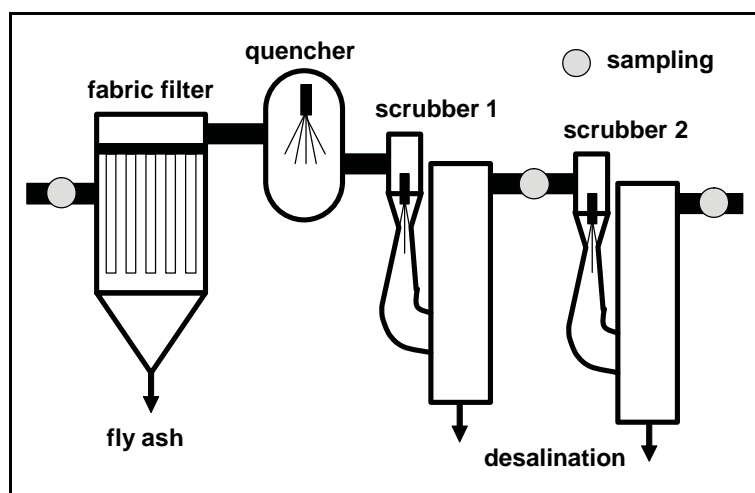

**Fig. 2** Scheme of part of the TAMARA air pollution control system with sampling points

A major target of the tests was the recovery of Br from the acid scrubber effluents. For this purpose a packed-column bypass scrubber system comprising three stages, two acid and a neutral one, was used during the last campaign. The two acid stages were operated in a counter current mode in order to concentrate HCl and HBr in the first scrubber.

### Material characterisation and experiment design

The reference fuel in TAMARA was a mix of pre-treated municipal solid waste (MSW), enriched by 30 % of a pelletised refuse derived fuel (RDF). The lower calorific value was thus adjusted to approx. 10 MJ/kg. During the co-combustion tests the RDF was replaced by

WEEE polymers in a way, that the total energy input into the furnace was kept constant at approx.  $0.5 \text{ MW}_{\text{therm}}$ .

The polymers used in the tests came from different industrial companies in Europe which are separating and shredding WEEE. Various types were subject of a first two weeks test campaign (Vehlow & Mark, 1997; Vehlow & Mark, 2000). Up to 12 wt % of plastic materials of the following types were added to the basic fuel:

- consumer type (small appliances, kitchen machines, PC, TV, ...)
- commercial type (medium size parts, PC, fax machines, ...)
- industrial type (mix of electrical housings, printed circuit boards, main frames, ...)

A fourth material simulated the composition of the actual European average polymer mixture and had been prepared by blending materials at that time (1996) sold on the market.

A second WEEE test campaign was mainly launched to investigate the chance of bromine recovery from the effluents of wet scrubbing systems (Vehlow et al. 2002). Up to 22 wt % of WEEE were added this time in order to increase the bromine inventory of the fuel mix to almost 1 wt %. The materials used were:

- mixed WEEE shredder residue (MIX, 2 types),
- shredded television back plates (TV/BP, 2 types), and
- shredded printed wiring boards (PWB).

All input and output mass flows have been recorded, sampled and analysed in order to calculate balances of single elements. Great efforts were made to analyse the different Br (HBr and  $\text{Br}_2$ ) and S species ( $\text{SO}_2$  and  $\text{SO}_3$ ) in the gas phase.

### Burnout of combustion residues

As found in former tests, the addition of high calorific waste fractions did neither deteriorate the combustion control nor the burnout quality of the solid residues and the off gas [Vehlow et al. 1996]. Fig. 30 documents with data from the second campaign that the addition of the WEEE plastic material caused no significant change of residual C in the grate ashes.

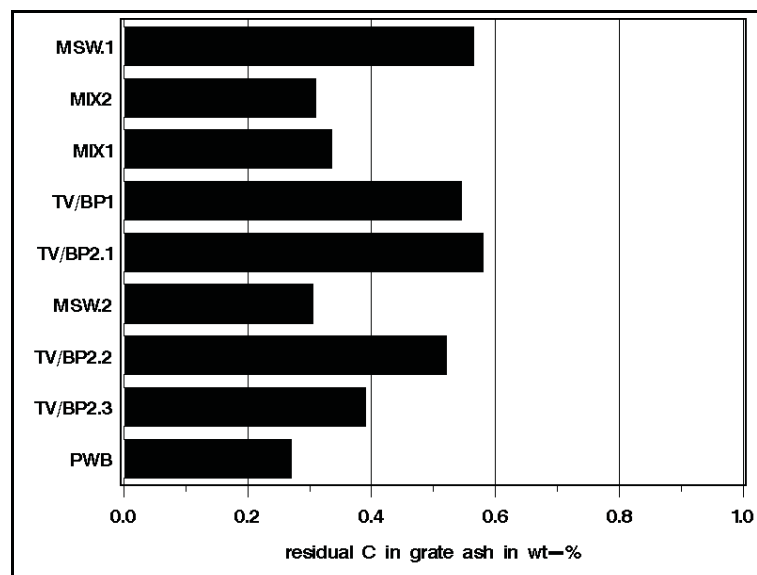

**Fig. 3** Residual C in grate ash of the second test campaign in wt % (MSW: reference tests)

The results of all tests were between 0.3 and 0.6 wt % which is the typical level found in bottom ashes from modern full-scale waste incineration plants in Europe. Calculating the global formation of products of incomplete combustion, the grate ashes delivered the greatest share.

The contribution of the other residues was much lower. The gas phase contained very low CO (<2 mg/m<sup>3</sup>) and TOC (<1 mg/m<sup>3</sup>) levels. In all tests more than 99 % of the total C fed into the incinerator was transformed into CO<sub>2</sub> with no significant difference between the reference tests (MSW.1 and MSW.2) and the co-combustion tests, as is pointed out in Fig. 4.

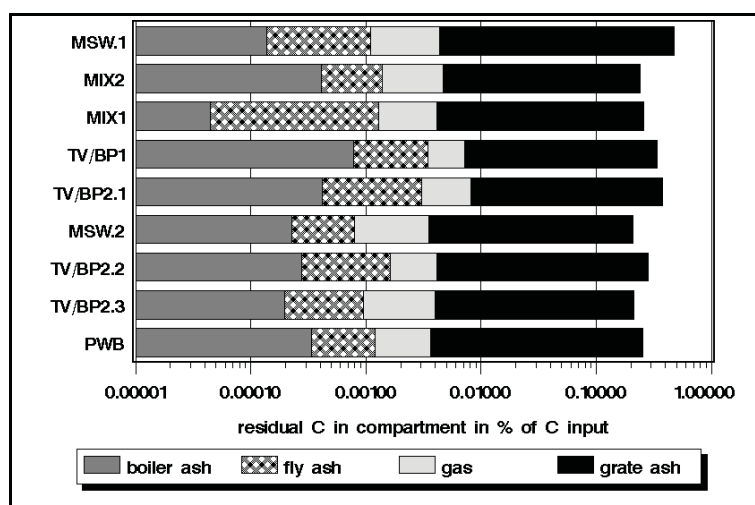

Fig. 4 Residual C in all residue compartments in wt % of the C input along with the fuel

### Thermal destruction of PBDD/F

Some flame retardants used in former times formed PBDD and PBDF during the compounding process. Although such formulations have been phased out after beginning of 1990, PBDD/F can be found today in some WEEE polymers. That is why in two trials, the co-combustion of MIX1 and that of TV/BP2, the WEEE plastics, the solid residues, and the raw gas have been analysed for these compounds. The results are depicted in Fig. 5.

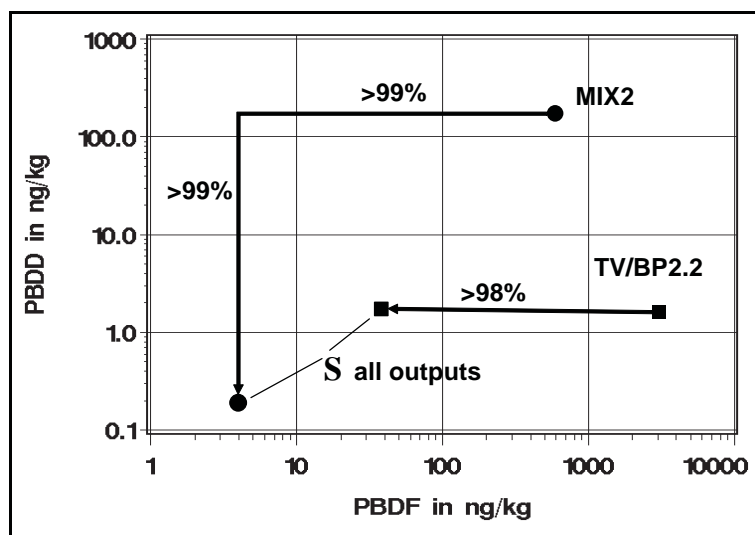

Fig. 5 PBDD/F reduction in TAMARA

The WEEE contained different levels of PBDD and PBDF. The MIX1 was characterised by high concentrations of both species, the dioxins (180 ng/kg) and the furans (600 ng/kg). The highly flame retarded TV back plates TV/BP2 were low in dioxins (20 ng/kg), but rather high in furans (3200 ng/kg).

The only combustion residue in which purely brominated congeners could be analysed was the raw gas where they almost totally stayed in the gas phase. The fly ash contained rather

small amounts only. The PBDD/F concentrations calculated for the combustion of 1 kg of the respective WEEE fraction were in both tests very low - as can be seen in Fig. 5 - and for the MIX1 run close to the detection limit. In the TV/BP2 trial the dioxins showed almost the same accumulated level in the residues as in the WEEE. All other calculated reduction efficiencies are in the order of 99 %.

The above calculated and in the graph indicated reduction values have to be interpreted as minimum thermal destruction yields since it cannot be excluded, that small amounts of PBDD/F have been formed in the heat recovery system from products of incomplete combustion.

These findings are in line with results from former tests in pilot scale, but also in full scale plants: a modern and well operated waste incineration plant has an extremely high destruction potential for organic compounds, even for such thermally stable ones like PCDD/F and CFC (chlorinated and fluorinated hydrocarbons) [Vehlow et al. 1990, Rittmeyer et al. 1993].

### Partitioning of bromine and its speciation in the gas phase

Br is the heavier homologue of Cl and the chemical properties of the two halogens are very similar. Its concentration in MSW is by more than one order of magnitude lower than that of Cl and that is why there is not much information found in literature on the behaviour of Br in waste incineration. The raw gas in a waste incinerator contains on an average  $< 10 \text{ mg/m}^3$  of HBr, compared to  $500 - 1000 \text{ mg/m}^3$  of HCl. Since the removal of HBr is at least as good as that of HCl - HBr is a stronger acid and hence the neutralisation potential against alkaline substances is higher - it is not of environmental concern, too. The only significant difference to Cl is the by far lower oxidation potential of the elementary species which - on the other hand - makes an oxidation of the conventionally stable negative oxidation state to the elementary form easy. If this happens a Br emission problem is very likely since  $\text{Br}_2$  is not removed in conventional gas cleaning systems without special countermeasures.

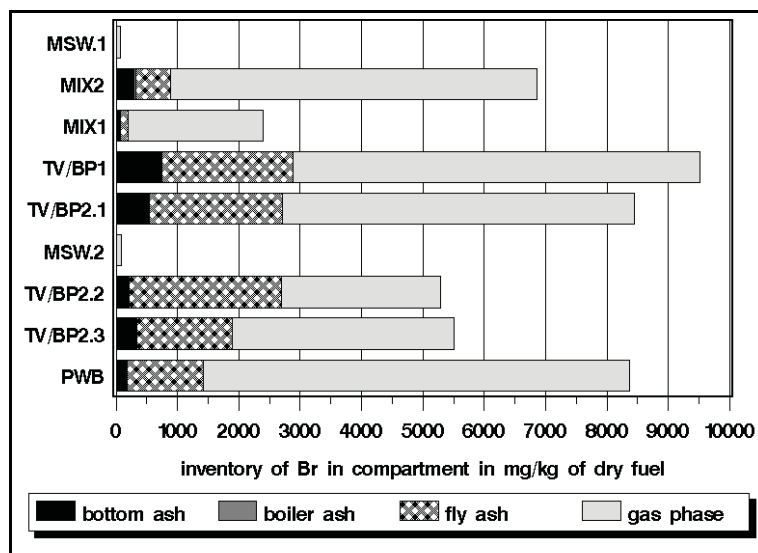

Fig. 6 Inventory and absolute partitioning of Br

The input of Br into TAMARA along with the WEEE materials reached almost 1 wt % in the dry fuel as can be seen in Fig. 6 which visualizes the total inventory and the absolute partitioning of Br between the various residue compartments of the second test campaign. The major fraction is - with one exception - found in the gas phase. Recent publications document a typical share of 80 – 90 % of the Br inventory being released into the raw gas in MSW combustion [Belevi & Mönch 2000] which is in line with our findings during the reference

tests. The TV back plates and to less extent also the PWB are showing a rather high fraction of Br staying in the fly ashes. This may be caused by alkaline filler material used in the back plates which can undergo a neutralisation by HBr in the gas phase already.

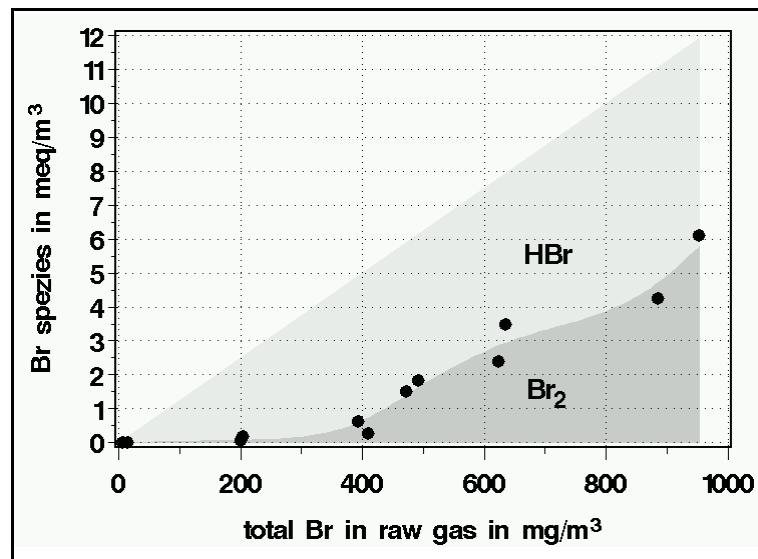

Fig. 7 Bromine speciation in the gas phase

The maximum Br raw gas concentration analysed in the first test campaign was approx. 250 mg/m³. Up to this concentration only traces (< 0.1 mg/m³) of elementary Br₂ could be detected in the gas phase and Br was present as HBr. In the second test campaign with its much higher Br inventory in the fuel, however, formation of Br₂ at higher Br concentrations in the raw gas was found. The speciation of the gaseous Br analysed in all tests is plotted in Fig. 7 in terms of meq/m³ as a function of the total concentration of gaseous Br in the raw gas.

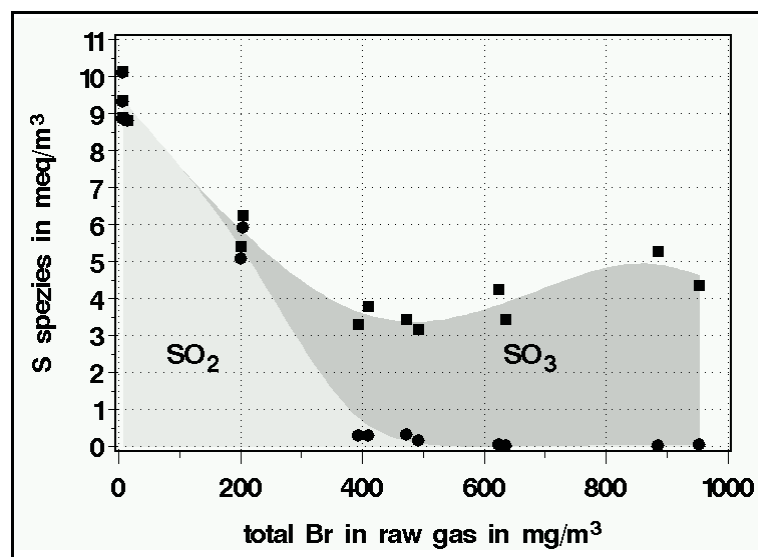
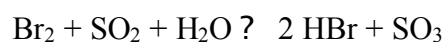

Fig. 8 Sulphur speciation in the gas phase

Another unexpected effect went along with the increase of the Br level in the raw gas: a permanent decrease of the concentration of SO₂. Gas sampling with impingers revealed an oxidation of SO₂ to SO₃ which was obviously caused by elementary Br₂ according to the chemical reaction



The concentrations of SO<sub>2</sub> and SO<sub>3</sub> are - again in terms of meq/m<sup>3</sup> - plotted in Fig. 8 against the total Br concentration in the raw gas. A comparison of both graphs indicates that the appearance of Br<sub>2</sub> falls almost together with the disappearance of SO<sub>2</sub>.

It can be speculated that the Br in the fuel is mainly released as Br<sub>2</sub> out of the fuel bed and that a certain surplus of SO<sub>2</sub> as reducing agent in the raw gas of a waste incinerator would suppress the transformation of Br into Br<sub>2</sub>. As a result of the described tests it is recommended in case of the combustion of fuel with high Br loads, to care for a SO<sub>2</sub> concentration of approx. 100 mg/m<sup>3</sup> in the gas phase to prevent Br<sub>2</sub> to be formed.

### Recovery of bromine

It has been demonstrated in former TAMARA campaigns that the implemented two-stage wet scrubbing system enables a very efficient removal of HBr in the acid scrubber [Vehlow & Mark 1995]. Br<sub>2</sub> present in the flue gas, however, is not absorbed in an acid solution and also in an alkaline scrubber its removal is rather limited. The measure of choice is the addition of a reducing agent to the alkaline scrubber. Industrial hazardous waste incinerators use in most cases Na<sub>2</sub>S<sub>2</sub>O<sub>3</sub> or Na<sub>2</sub>SO<sub>3</sub>. After having experienced that Br<sub>2</sub> is formed, Na<sub>2</sub>S<sub>2</sub>O<sub>3</sub> has been added to the second scrubber of TAMARA. This strategy resulted in a very high Br removal efficiency over the total air pollution control system.

**Table 1** Br in raw gas, scrubber effluents, and removal efficiency ? (\*: without Na<sub>2</sub>S<sub>2</sub>O<sub>3</sub>)

	<i>HBr</i>	<i>Br<sub>2</sub></i>	<i>scrub. 1</i>	<i>scrub. 2</i>	<i>?</i>
	[mg/m <sup>3</sup> ]	[mg/m <sup>3</sup> ]	[g/l]	[g/l]	[%]
<i>MIX1</i>	190	9	2.5	3.2	99.18
<i>MIX2</i>	340	240	3.7	7.7	68.78*
<i>TV/BP1</i>	400	135	6.4	14.3	93.18
<i>TV/BP2.1</i>	415	35	7.3	11.3	95.77
<i>TV/BP2.2</i>	225	0.2	4.5	4.2	99.33
<i>TV/BP2.3</i>	280	3.8	7.6	8.7	99.22
<i>PWB</i>	405	415	9.6	20.4	96.79

The HBr and Br<sub>2</sub> concentrations in the raw gas, the Br concentrations in both scrubbers, and the removal efficiency from the raw gas are compiled in Table 1 for all co-combustion tests. With the exception of one test, where no Na<sub>2</sub>S<sub>2</sub>O<sub>3</sub> had been added, the overall removal efficiency is exceeding 93 and in some cases 99 %. That means that >50 - 90 % of the total Br inventory has been accumulated in the scrubber solutions.

In the acid scrubber effluents concentrations of up to 10 g/l were obtained. In a special counter-current bypass scrubber for concentrating HBr in the acid scrubbing stage maximum Br concentrations up to 18 g/l could be reached. The most convenient Br recovery method from acid solutions is the oxidation by Cl<sub>2</sub> to Br<sub>2</sub> which is blown out of the solution. In the alkaline scrubber with Na<sub>2</sub>S<sub>2</sub>O<sub>3</sub> addition up to 20 g/l of Br<sup>-</sup> were found. This bromide can be recovered by distillation or chlorination processes.

### Heavy metal volatilisation

It is well known and has been found in former TAMARA tests, too, that Cl promotes the volatilisation of heavy metals out of the fuel bed by the formation of metal chlorides [Vehlow et al. 1996, International Ash Working Group 1997]. The same effect should theoretically be seen



for Br, since many bromides have similar boiling points as the chlorides of the respective metals. This is documented for a selected number of elements in Table 2.

**Table 2** Boiling points (BP) of selected metal chlorides and bromides

	<i>BP</i> [°C]		<i>BP</i> [°C]		<i>BP</i> [°C]
<i>Cu<sub>2</sub>Cl<sub>2</sub></i>	1367	<i>CdCl<sub>2</sub></i>	960	<i>Hg<sub>2</sub>Cl<sub>2</sub></i>	384
<i>Cu<sub>2</sub>Br<sub>2</sub></i>	1345	<i>CdBr<sub>2</sub></i>	863	<i>Hg<sub>2</sub>Br<sub>2</sub></i>	345
<i>ZnCl<sub>2</sub></i>	732	<i>SnCl<sub>2</sub></i>	652	<i>TlCl</i>	720
<i>ZnBr<sub>2</sub></i>	650	<i>SnBr<sub>2</sub></i>	620	<i>TlBr</i>	815
<i>AsCl<sub>3</sub></i>	130	<i>SbCl<sub>3</sub></i>	283	<i>PbCl<sub>2</sub></i>	950
<i>AsBr<sub>3</sub></i>	221	<i>SbBr<sub>3</sub></i>	280	<i>PbBr<sub>2</sub></i>	916

In MSW incineration the Br effect is not recognized due to the low concentration of Br compared to Cl in waste. Furthermore, the molar concentration of the halogens is controlling the volatilisation and that again - the much higher atomic weight of Br (80 g/atom) compared to that of Cl (35.5 g/atom) - prevents a separation of the influence of both elements. Another factor impedes an accurate investigation: the sampling and analysis error. Hence the following considerations are more discussing tendencies than fixed laws.

If the Br inventory in the fuel is increased, the specific activity of Br should become more evident. There was in fact an indication in that direction already in former tests on Br containing fuel like flame retarded PUR and XPS foams in TAMARA [Vehlow 2000]. The WEEE tests, especially the second campaign, allowed a better discrimination of the effects of the two halogens. In terms of mass concentration the Br inventory reached almost the same order of magnitude as that of Cl. Because of the higher atomic weight the equivalent concentration stayed of course by almost one order of magnitude lower.

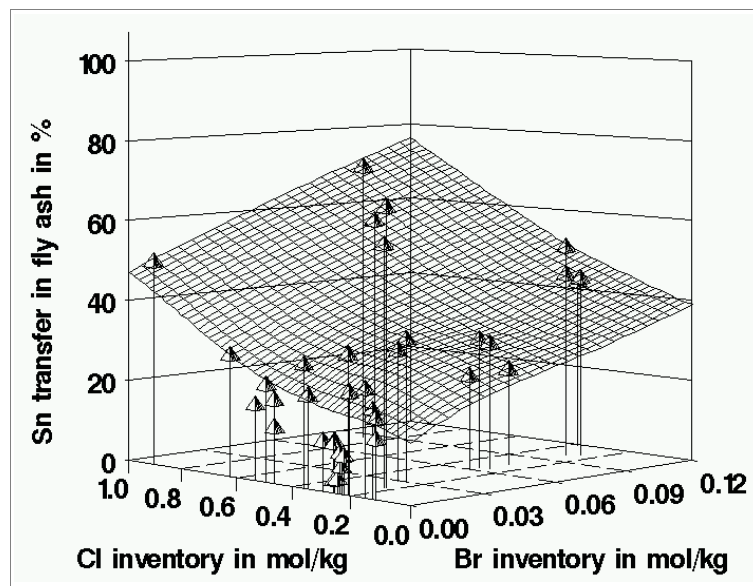
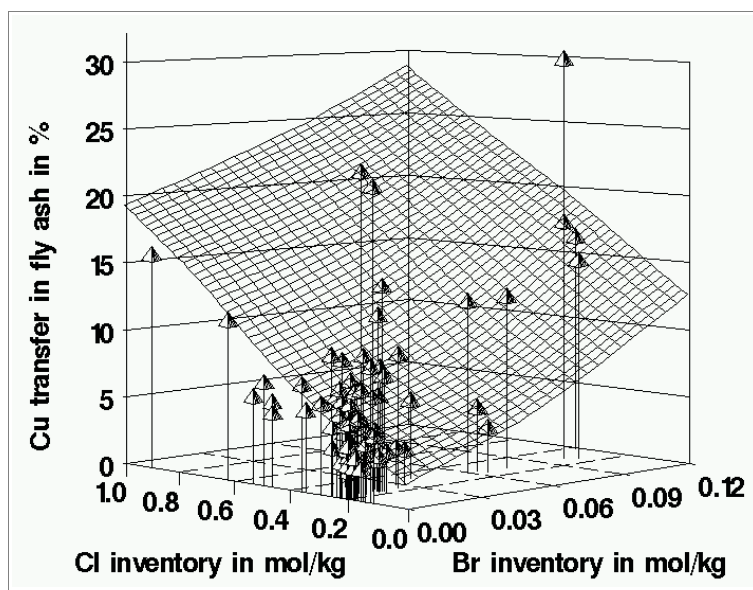

**Fig. 9** Effect of Cl and Br on Sn volatilisation (combined data from WEEE and other tests)

Good results were obtained for Sn, the inventory of which was almost of the same order of magnitude in all test runs. As the three-dimensional graph in Fig. 9 points out, during the reference tests - at low Cl and Br inventory - approx. 5 to 15 % of the metal were transferred out of the fuel bed into the fly ashes. The co-combustion of WEEE plastics increased that number

to approx. 30 % in case of high Br load and to even more than 50 % in those runs, where high Cl and Br inventories were established. Regarding the different scale of the Cl and the Br axis, the promoting influence of Br seems to be more pronounced than that of Cl. Such finding is in line with the lower boiling point of the bromide of this metal which is about 30 °C below that of the chloride.

Similar results with higher scattering were obtained for other volatile metals like Cd and Zn. But also low volatile metals like Cu and even Fe showed a surprisingly distinct separation of the respective influence of the two halogens. Fig. 10 depicts the situation found for Cu. The graph documents again a strong influence of Br.



**Fig. 10** Effect of Cl and Br on Cu volatilisation (combined data from WEEE and other tests)

The promotion of metal volatilisation by the halogens Cl and Br transfers significant amounts of heavy metals into the fly ashes of waste incineration plants. This should theoretically favour the recovery of these metals from the filter ashes. Respective processes have been developed, for economic reason, however, no such process is implemented in full scale today.

Nevertheless, the fly ashes are valuable materials concerning their inventory of various metals. If a recovery does not pay today, it may do so tomorrow. Hence it should be considered to store fly ashes in a way, that future generations have access and can ‘mine’ them again.

### **Effect of Bromine on the Formation of Halogenated Dibenzo-p-dioxins and Dibenzofurans**

The former tests on the co-combustion of various plastic waste streams in TAMARA have already proofed, that neither high amounts of Cl [Vehlow et al. 1996], nor those of Br [Vehlow & Mark 1995, Vehlow et al. 2000] influence the total level of halogenated dioxins in the raw gas of waste incineration plants, provided a good combustion control is taken care of. These results could be confirmed by the tests described here. The bar plot in Fig. 11 shows again that there is no correlation between the Br inventory in the fuel and the total concentration of chlorinated dioxins and furans in the raw gas.

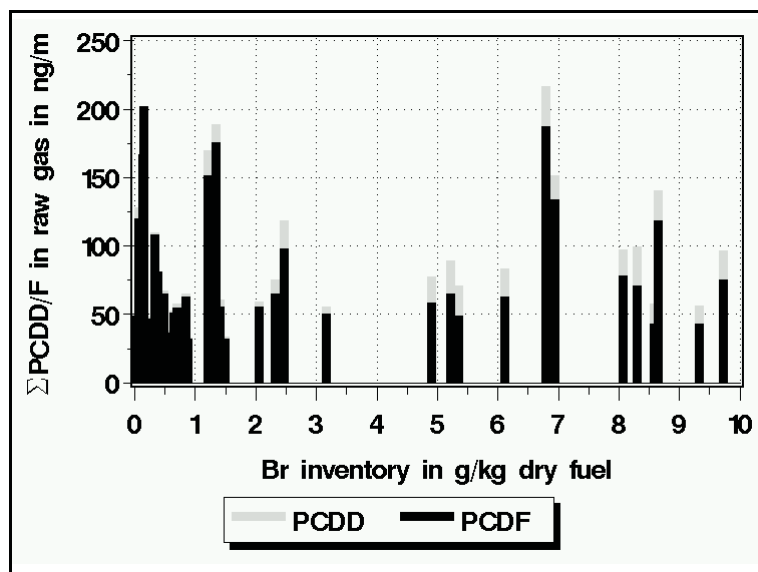

**Fig. 11** PCDD/F as function of the Br inventory

If only MSW was burnt, there were almost no Br containing dioxins or furans to be analysed in the raw gas. However, if the Br concentration in the fuel was increased, an increase of dioxins and furans - with the furans by far prevailing - containing one or two Br atoms was detected, which levels off at high Br concentrations [Hemminghaus et al. 1997]. Congeners with more than 2 Br atoms and purely brominated congeners could rarely be found.

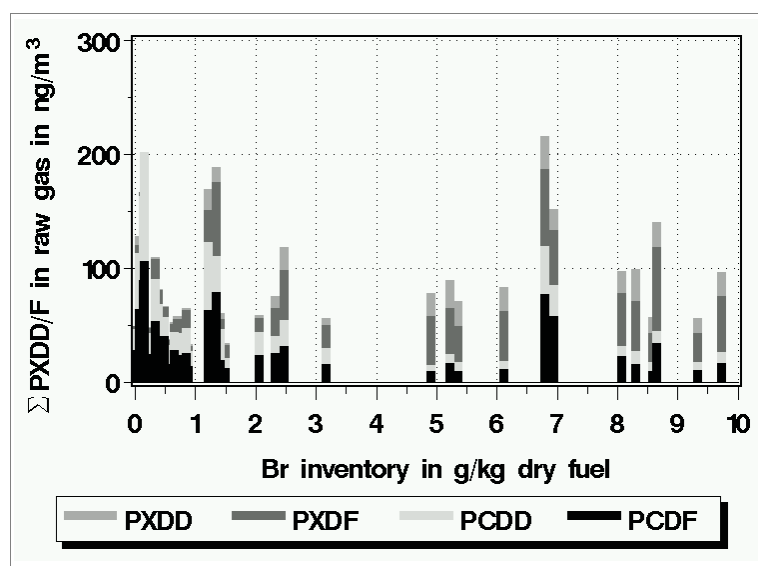

**Fig. 12** Total sum of halogenated dioxins and furans as function of the Br load in the fuel for all TAMARA co-combustion tests

Accumulating all halogenated dioxins and furans, these tests with extremely high Br levels and even with the presence of elementary  $\text{Br}_2$  in the raw gas confirmed the earlier finding: the total dioxin level depends much more on the quality of the combustion control than on the level of halogens in the fuel. The compilation in Fig. 12 of all TAMARA results from co-combustion of plastic wastes with elevated Br inventories documents clearly, that there is no significant dioxin increase with increasing Br load. At high Br level, however, more Br containing dioxins and furans can be found than purely chlorinated ones.

In former test campaigns it was demonstrated that the emission of halogenated dioxins and furans is easily controlled by a coal filter. Downstream of such filter PCDD/F concentrations

well below the German emission standard of  $0.1 \text{ ng/m}^3$  - which is typically met by modern waste incineration plants - have been obtained with no Br containing congeners detectable.

### **Energy Recovery in Waste Incineration**

All German and most European waste incineration plants are equipped with energy recovery systems. The boiler of a modern waste incinerator has a primary energy efficiency of  $> 80 \%$  which is almost as high as that in a coal fired power plant. If electric power is generated the efficiency is typically  $20 - 24 \%$ . In many plants combined heat and power strategies are followed and that means that up to  $60 \%$  of the energy inventory of any waste fraction - including plastic materials - can be recovered in such facilities. Since the co-combustion tests revealed neither a negative influence of high amounts of polymers nor one of high levels of halogens on the combustion process, this degree of energy recovery will also be reached if WEEE polymers are disposed of in municipal solid waste incineration plants.

### **Conclusions**

Co-combustion tests of up to  $22 \text{ wt } \%$  of flame-retarded WEEE polymer fractions together with a pre-treated municipal solid waste in the Karlsruhe TAMARA pilot plant for waste incineration extended the range of Br inventory in the waste to an approx. 100 times higher level than in MSW incineration plants. Such high addition of WEEE, which will never be reached in full scale, was chosen to identify any adverse effects. The major findings of the program were:

- The addition of high loads of plastic material with high loads of Br had no negative influence on the combustion performance in the waste incinerator and allowed an efficient energy recovery.
- PBDD/F present in old WEEE have been reduced by more than  $99 \%$ , emissions into the gas are almost negligible and the safe disposal of the grate ashes demonstrate the high environmental performance of co-combustion of WEEE plastics.
- $50 - 90 \%$  of the Br inventory was released into the raw gas. As soon as the total Br concentration in the gas phase exceeded  $300 \text{ mg/m}^3$  the appearance of elementary  $\text{Br}_2$  could be observed. This went along with the disappearance of  $\text{SO}_2$  and the finding, that at high Br loads all S in the gas phase was present as  $\text{SO}_3$ . If a reducing agent is added to the neutral scrubber, high abatement efficiencies could be obtained also for elementary  $\text{Br}_2$ .
- In the effluents from the acid scrubber of TAMARA a Br concentration of up to  $10 \text{ g/l}$  could be reached. This concentration could be increased to almost  $20 \text{ g/l}$  in the first stage of a counter-current two stage acid scrubbing system. In the effluents from the second scrubber again Br concentrations up to  $20 \text{ g/l}$  were obtained. This enables the recovery of  $>50 - 90 \%$  of the Br inventory.
- As experienced in earlier co-combustion tests the volatilisation of heavy metals was promoted by the Br as well as by Cl, which reduces the heavy metal inventory of the bottom ash and helps to meet landfill leaching regulations.
- The elevation of the Br inventory did not increase the formation of chlorinated dibenzo-p-dioxins and dibenzofurans. Like in former tests an increased Br concentration correlated with an increase in Br containing congeners with the preference on the formation of dibenzofurans. The summation of all halogen containing dibenzo-p-dioxins and dibenzofurans resulted in an almost constant total dioxin concentration.
- The co-combustion experiments did not indicate that increased WEEE proportions in waste feed adversely influenced the quality of waste incineration. The expected increased formation of Br containing dibenzo-p-dioxins and dibenzofurans stayed moderate even when high proportions of WEEE plastic material were added. In full scale incineration

plants the co-feeding of high calorific waste fractions will be limited to 3 - 5 wt % as a worst case. In those cases the contribution of Br containing species to the dioxin and furan levels should be very low. The higher molecular weight of mixed halogenated congeners should especially care for a good removal of those congeners in adsorptive abatement processes.

## Recommendations

On the basis of the results presented here it seems fair to state that MSW combustion is an ecologically sound and economically acceptable disposal route for limited amounts of specific plastic fractions of WEEE. The metal content, however, should be reduced as is done today in most recycling operations in order to save the grate from negative effects by melting of e.g Al, Zn, Sn, or Pb and to minimize the amount of metallic species in the grate ashes.

## Acknowledgements

The authors want to thank H. Gramling and his colleagues for the excellent operation of TAMARA and H. Bautz, O. Dregert, A. Gerig, G. Häfele, P. Hammer, J. Marquardt, H. Reis, R. Siegel, R. Walter, J. Wilhelm and G. Zwick for the careful sampling and performance of the extended analytical program. Further contributions to the design and evaluation of the program were made by H. Fisch (APME), L. Tange (Eurobrom B.V. DSBG) and D. Drohmann (Great Lakes Chemical). The authors are very grateful for all of these contributions.

## References

- Belevi H, & Moench H (2000) Factors determining the element behavior in municipal solid waste incinerators. 1. Field studies. *Environmental Science & Technology* 34, 2501
- Funcke W., Hemminghaus H.-J., Mark F.E. & Vehlow J. (1997). PXDF/D in Flue Gas from an Incinerator Charging Wastes Containing Cl and Br and a Statistical Description on the Resulting PXDF/D Combustion Profiles. *Organohalogen Compounds*, 31, 93
- Hornung A., Koch W., Schoener J., Furrer J., Seifert H. & Tumiatti V. (2002) Environmental Engineering – Recycling of Electronic and Electrical Equipment (EEE). *IT3 Conference, New Orleans. Proc. CD ROM*
- International Ash Working Group (IAWG): Chandler A.J, Eighmy T.T., Hartlén J., Hjelmar O., Kosson D.S., Sawell S.E., van der Sloot H.A. & Vehlow J. (1997) *Municipal Solid Waste Incinerator Residues*. Amsterdam, NL: Elsevier
- Rittmeyer, C. & Vehlow, J. (1993), Decomposition of Organohalogen Compounds in Municipal Solid Waste Incineration Plants. Part I: Chlorofluorocarbons, *Chemosphere*, 26, 2129
- Vehlow, J., Braun, H., Horch, K., Merz, A., Schneider, J., Stieglitz, L. & Vogg, H. (1990) Semi-Technical Demonstration of the 3R Process, *Waste Management & Research*, 8, 461
- Vehlow J & Mark F.E. (1995) *Co-combustion of building insulation foams with municipal solid waste. APME technical paper*, APME, brussels
- Vehlow J., Wanke T. & Mark F.E. (1996) Co-Verbrennung von Kunststoffabfällen und Hausmüll - Basisversuche in der Testanlage TAMARA. *VDI Berichte* 1288, 263
- Vehlow J. (2000) Influence of Bromine on Metal Volatilisation. *Journal of Material Cycles and Waste Management*, 2, 89
- Vehlow J, Bergfeldt B., Jay K., Seifert H., Wanke T. & Mark F.E. (2000) Thermal Treatment of E+E Waste Plastics. *Waste Management and Research*, 18, 131
- Vehlow J., Bergfeldt B., Hunsinger H., Jay K., Mark F.E., Tange L., Drohmann D. & Fisch H. (2002) Recycling of bromine from plastics containing brominated flame retardants in state-of-the-art combustion facilities. *APME TEC Report*, APME, Brussels

# **Evaluation of formal kinetic parameters concerning the gasification of bio-polymeric materials**

Ursel Hornung, Frank Richter, Lambert Krebs  
Forschungszentrum Karlsruhe  
Institut für Kern- und Energietechnik  
Hermann-von-Helmholtz-Platz 1  
76344 Eggenstein-Leopoldshafen

## **Introduction**

The present energy consumption is expected to double in about 50 years and fossil fuels contribute about three quarters to the world energy mix. Biomass contributes about 10 % to today's world energy supply, taking in account that in many developing countries its contribution ranges from 40 to 50 % due to the high usage of firewood and charcoal, which is the traditional energy source from biomass even in our days. Within the EU the contribution is only about 3 %. Due to in particular on fossil oil based industrial processes and commercial equipment the use of firewood and charcoal is limited. In order to increase the energy recovery from biomass in Europe - EU intends to double the biomass share until 2010 – it is necessary to develop techniques which make a possible conversion of biomass to a more suitable form, such as a liquid or gas. Energy recovery from biomass has two striking characteristics concerning global recycling. First biomass fixes carbon oxide in the atmosphere by photosynthesis, secondly especially Lignocellulosic by-products from crops, as for instance straw, from agriculture are abundant, since they are coupled with food production and growth in portion to the population. A rough estimate with half of the straw harvest available for energy gives a small but significant 5 % contribution to the world primary energy, about half of this value is valid for the EU. Therefore, the development of new processes of energy recovery from biomass is essential and for this reason some groups within the Forschungszentrum of Karlsruhe are engaged with the development of an innovative procedure for energy recovery from biomass. One major point of this project is the fuel conditioning. It is intended to gain oil in a first step, for instance from fast pyrolysis, and then to mix this oil with occurring coke to a slurry. This seems to be necessary because the oil from biomass has a low heating value, nearly half of fossil oils. Together with coke the energy containment is enhanced and waste avoided. In order to classify and describe these slurries and their combustion behaviour various testing facilities are needed. One problem is to describe the reaction of coke particles in a combustion environment. For that reason a parallel flow reactor with particle injection is used to describe coke reactions in a CO<sub>2</sub> rich environment. With the help of this reactor kinetic constants for the reaction coke + CO<sub>2</sub> will be achieved in a first step. Later on other reactions and various cokes will be examined. In order to gain kinetic constants the measured conversion rates needed to be analysed and treated according different models for coke gasification reactions. The focus of this contribution will be to give an overview about possible reaction models.

## **Reaction models for coke gasification reactions**

As gasification proceeds, coke loses mass. The gasification rate can be considered as:

$$r = \frac{1}{W} \frac{dW}{dt} = \frac{1}{1-x} \frac{dx}{dt}$$

where  $r$  is the normalized gasification rate,  $t$  is time,  $W$  is the coke mass at time  $t$ ,  $x$  is coke conversion

$$x = \frac{W_0 - W}{W_0}$$

and  $W_0$  is the initial mass of coke.

Different models have been proposed to describe gasification rates for instance in case of coal gasification. Models which do not consider structural changes during reaction are most simple. The homogenous model and the unreacted core model are examples of this type of models. Although the relationship between reaction rate and surface area has been widely studied in case of coal gasification there is no general agreement [1]. Some authors state that reaction rate is proportional to surface area [2, 3]. However, most studies found that surface area and reaction rate are not proportional [1]. Proportionality is rather found between reaction rate and other parameters such as ASA [3, 4] and O [4, 5] (coal moisture holding capacity). ASA is related to the amount of oxygen chemisorbed by coal and O with the total micropore volume [6]. Parameters like ASA and O are apparently more related to the number of active sides on coal surfaces, rather than to the total surface area.

#### *Homogenous model*

This model reduces the heterogeneous gas – solid reaction of coke to a homogeneous reaction by assuming that the gas is reacting with coke in all possible places, both outside and inside the particle surface. Reaction rate expression are:

$$x = 1 - \exp(-kt)$$

$$\frac{dx}{dt} = k(1-x)$$

where  $k$  is the reaction constant and  $x$  the conversion.

#### *Non-reacted core model*

Reacting coke particles are considered as spherical grains whose radius decreases as gasification reaction advances. If chemical reaction is the controlling step, the gasification rate is given by:

$$x = 1 - (1 - kt)^3$$

$$\frac{dx}{dt} = 3k(1-x)^{2/3}$$

where  $k$  is again the reaction constant.

Random pore models, in contrast, do consider structural changes during gasification reaction.

*Random pore model*

Bhatia and Perlmutter [7] found that a random pore model that can be applied to for instance coal gasification reactions. They considered the random overlapping of pore surfaces, which reduced available for reaction. The equations of this model are:

$$x = 1 - \exp\left[-\tau\left(1 + \frac{\psi\tau}{4}\right)\right]$$

$$\frac{dx}{dt} = (1-x)\sqrt{[1-\psi \ln(1-x)]} \quad \text{with} \quad \tau = \frac{K_s C^n S_0 t}{1-\epsilon_0}$$

where  $S_0$  is the surface area at  $t = 0$ ,

$$S_0 = \int_0^{\infty} \frac{V_0(r)}{r} dr$$

$V_0(r)$  is the pore volume distribution ( $\text{m}^2/\text{g}$ ) determined by  $\text{CO}_2$  at 273 K.

$$\psi = \frac{4\pi L_0(1-\epsilon_0)}{S_0^2}$$

is a structural parameter,  $L_0$  is the pore length at  $t = 0$ ,

$$L_0 = \frac{1}{\pi} \int_0^{\infty} \frac{V_0(r)}{r^2} dr$$

and  $\epsilon_0$  is the coal porosity at  $t = 0$ ,

$$\epsilon_0 = \frac{1}{\pi} \int_0^{\infty} V_0(r) dr$$

$S_0, L_0$  and  $\epsilon_0$  represent the surface area, length and total volume of a system which is made by the random overlapping of cylindrical surfaces whose size distribution is  $V_0(r)$ .

Galvas [8] also considered the random pore overlapping in the char reaction, but unlike Bhatia and Permuter [7], he assumed the shape of pores as cylindrical, straight and infinitely long capillaries. He used a single density function for calculating the number of overlappings, the length of pores and the change of volume and area during reaction. By this treatment, he obtained the following relations:

$$x = 1 - \exp[-2\pi t(A_0 t + 2A_1)]$$

$$\frac{dx}{dt} = 4\pi(1-x)\sqrt{A_1^2 + A_0 \ln(1/1-x)}$$



where  $A_0$  and  $A_1$  are empirical constants. These equations are very similar to those of Bhatia and Permutter. The main difference is the way of finding the constants. A third group of authors [9,10] favour semiempirical models as follows.

*Johnson model* [1,9]

According to this model:

$$\frac{dx}{dt} = f_1 k_t (1-x)^{2/3} \exp(-\alpha x^2)$$

where  $f_1$  is the relative reactive factor, which depends on the char type and heat-treatment temperature;  $k_t$  is a kinetic constant, which depends on partial pressures of reacting gases;  $\alpha x^2$  represents the relative influence of the effective surface area, which decreases with conversion. If  $\alpha = 0$ , the Johnson model becomes the same as the non-reacting core model; if  $\alpha = 1$ , the model can be represented by the homogeneous model for conversions below 0.75.

*The Dutta and Wen model* [10]

Dutta introduces a new factor 'a' into the rate expression. This 'a' is defined as the ratio between the available pore surface area per unit weight at any stage of conversion and the initial pore surface area per unit weight.

$$a = 1 \pm 100x^{\nu\beta} \exp(-\beta x)$$

Here,  $\nu$  and  $\beta$  are constants which depend on each char. The rate expression for this model is therefore:

$$\frac{dx}{dt} = akC_g (1-x)$$

which is the same equation as that for a homogenous reaction except the new factor 'a' has been included.

*Modified volumetric model* [1,11]

Kasaoka et al [11] uses a reaction model which modifies the equation of the homogenous model by adding a parameter in the power of which expresses a kind of reaction order. By applying this parameter the homogenous model expression get closer to the random pore models in which a two-order polynomial is the power of time.

$$x = 1 - \exp(-at^b)$$

$$\frac{dx}{dt} = a^{1/b} b(1-x)[- \ln(1-x)]^{(b-1)/b}$$

*The Adshiri andFurusawa model* [3]

This model considers that the homogenous model is sufficient for high porosity ( $> 0.5$ ) cokes. Adshiri and Furusawa include the value of the surface area and by semiempirical experiments conclude that:

$$\frac{dx}{dt} = S_{(x)}k = k(1-x)$$

where  $S_{(x)}$  is the surface area.

The semiempirical models like the Johnson model and the modified volumetric models have the advantage that they describe the change of reaction rates with conversion more precisely. The same is true for the theoretical models like the random pore models which make assumptions concerning the pore structure of coal or coke. If all parameters are available and assumptions are feasible these models are preferable. But in most cases the relation between time and conversion is sufficiently described by the homogeneous and non-reactive core models. This is the case for reactivity studies of different coals, catalyst investigations and the determination of kinetic constants in dependence of temperature. In Molina et al.'s [1] review the purpose of various studies is related to the used models. He demonstrated in a comparison that the homogenous, the non-reactive and the modified volumetric model are widely used for the determination of kinetic constants.

### References

- [1] Molina, A., Mondragon, F., *Fuel*, 1998, **77**, 1831.
- [2] Chin, G., Rimura, S., Tone, S., and Otake, T., *Int. Chem. Eng.*, 1983, **23**, 105.
- [3] Adschiri, T. Shiraha, T., Kojima, T., and Furuzawa, P., *Fuel*, 1986, **65**, 1688.
- [4] Alvarez, T., Fuertes, A.B., Pis, J.J. and Ehrburger, P., *Fuel*, 1995, **74**, 729.
- [5] Kasaoka, S., Sakata, Y., and Shimada, M., *Fuel*, 1987, **66**, 697.
- [6] Miura, K., Hashimoto, K. and Silveston, P. *Fuel*, 1989, **68**, 1461.
- [7] Bhatia, S.K. and Perlmutter, D.D., *AIChE Journal*, 1980, **26**, 379.
- [8] Galvas, G., *AIChE Journal*, 1980, **26**, 577.
- [9] Goyal, A., Zabransky, R. F. and Rehmat, A. *Ind. Eng. Chem. Res.*, 1989, **28**, 1767.
- [10] Dutta, S., Wem, C.Y., and Belt, R., *J. Ind. Eng. Chem. Process Des. Dev.*, 1977, **16**, 20.
- [11] Lee, W.J. and Kim, S.D., *Fuel*, 1995, **74**, 1387.

**Directive on Used Electric and Electronic Equipment**  
**Directive on the Restriction of Use of Certain Hazardous**  
**Substances in Electric and Electronic Equipment**

Günther Albrecht  
Ministry of the Environment and Transport  
Baden-Wuerttemberg

On a proposal of the European Commission, the European Parliament and the Council of the European Union have adopted the Directive on Used Electric and Electronic Equipment (directive 2002/96/EG) as well as the Directive on the Restriction of Use of Certain Hazardous Substances in Electric and Electronic Equipment (2002/95/EG). On 13 February 2003, these directives were published in the Official Journal of the European Union (ABL. L37/24, L37/19 dated 13 February 2003). Future implementation of these directives will result in significant changes for the manufacturers of such equipment, disposal companies, and urban and rural districts which have been responsible so far for the proper collection and disposal of used electric and electronic equipment from private households as so-called public waste management organizations. According to the schedule given by the 2002/96/EG directive, product responsibility as previously described in the ordinances on the disposal of packagings and old batteries will also apply to the disposal of used electric and electronic equipment from August 2005 at the latest. Under this conception of product responsibility, the manufacturers of electric and electronic equipment then will also be responsible for the proper disposal of such equipment. Within the time limit set – by 13 August 2004 - , the federal government is obliged to implement these directives by translating them into national law. To reach the objectives mentioned in the directives, the obligations of the traders shall be defined by a federal decree according to the Waste Recycling and Management Act, namely, the **Federal Ordinance on Used Electric and Electronic Equipment (ElektroV)**.

## Major Features of the Directives

When implementing the directives in German law, the federal government among others will pursue the following objectives:

- Solutions conforming to competition
- Activation of private responsibility
- Consideration of proven and tested disposal elements

The obligations as described by the future Ordinance on Used Electric and Electronic Equipment will be based on the following central elements:

- End users and distributors of electric equipment may return used equipment at no costs;
- By 31<sup>st</sup> December 2006 at the latest, at least 4 kg of used equipment per inhabitant and year shall have been collected separately from private households;
- Manufacturers and importers shall be obliged to establish return and receiving stations for the consumers to return used electric and electronic equipment;
- Also in the future, municipal collections as far as the return station may be organized as alternatives to the manufacturers'/distributors' obligation;
- The manufacturers shall bear the costs of the collections, recycling, and disposal of used equipment (from a defined receiving station at least). As far as the financing of the disposal costs is concerned, it is distinguished between used equipment and equipment put in circulation after 13 August 2005;
- For used equipment that has been on the market before the directive becoming effective already, collective financing of the disposal of used equipment by the manufacturers according to their market share shall be permitted for both used equipment from private households and from other users (trade);
- During a transition time (8 years or 10 years for certain equipment), the manufacturers may charge the costs for the collection, treatment, and environmentally compatible disposal to the buyer ("visible fee") on a voluntary basis when selling new products;
- As far as products put in circulation after 13 August 2005 are concerned, each manufacturer shall be responsible for the proper disposal of his own products; he shall be free to fulfill his obligation either individually or by participation in a collective system;
- The manufacturers shall be obliged to use the best available technology for the treatment of used equipment;
- In the interest of environmental protection, member states may specify minimum quality standards for the treatment of used electric and electronic equipment;

- Regarding the recycling of used electric and electronic equipment, the directive contains various recycling rates for the ten equipment categories mentioned there. These rates will have to be complied with by the manufacturers until 31 December 2006. Depending on the equipment category, recycling rates vary between 70 and 80%;
- The manufacturers shall be obliged to inform about and report the number of new devices entering the market and the equipment mass transferred to a treatment plant;
- The manufacturers shall ensure that equipment put in circulation from 1 July 2006 does no longer contain certain hazardous substances, such as lead, mercury, cadmium, hexavalent chromium, polybrominated biphenyl or polybrominated diphenyl ether.

### Translation of the requirements into a national Ordinance on Used Electric and Electronic Equipment

After more than 10 years of tough struggling for the responsibility for a proper and environmentally compatible recycling of used electric and electronic equipment, binding EU directives have now been adopted. In the past years, conflicting interests of the traders have prevented a national regulation from being formulated. To remind you: In 1991 already did the federal government submit a first draft Ordinance on the Taking Back of Used Electric and Electronic Equipment. Boundary conditions of a common environmental policy in the member states have now been specified through the directives adopted. Still, there is the danger that the implementation of these directives, in particular the Directive on Used Electric and Electronic Equipment, will result in varying regulations in the member states, which may cause differing financial burdens for the traders. In the opinion of the Ministry of the Environment and Transport, this is due to the fact that the directive remains behind the level required to ensure comparable national standards in the member states. This applies to e.g. who will bear the costs of the collection of used equipment from private households to the return station defined and which requirements are made on the treatment of used equipment in the interest of environmental protection. It is also open whether the legislator, in the interest of small and medium-sized disposal companies, shall interfere with the future manufacturers' practice of calling for tenders or whether the awarding of contracts covering extensive service packages, which may possibly enhance return concentrations of monopoly character, shall remain subject to market forces. Moreover, information and reporting obligations of the manufacturers and treatment plants with regard to the masses and recycling rates of used equipment as

well as the implementation of the envisaged registration remain to be discussed. As illustrated by the examples given, definition of the new Ordinance on Used Electric and Electronic Equipment promises to bring about interesting and enthralling debates within the next months. According to first notifications, the federal government intends to submit a draft on the implementation of these directives until the 2003 summer break for parliamentary negotiations to start after the summer break. It will depend on the exact definition of this ordinance whether the change towards an environmentally sustainable handling of materials flows as envisaged by the Waste Recycling and Management Act will enter entrepreneurial practice and whether the requirements for a simple and rapid recycling will be complied with by the manufacturers while designing their products already.

## **Outlook**

The Ministry of the Environment and Transport of Baden-Wuerttemberg has long since pursued the objective of promoting the disposal of used electric and electronic equipment using advanced technology. Although utilization of plastics from the recycling of used electric equipment has been subject of research and development for several years now, it is far more difficult to achieve than in the packaging sector. Hence, utilization of plastics from the disassembly of used electric and electronic equipment has been restricted to individual initiatives of particularly committed enterprises so far.

In the past, the Ministry initiated a number of research projects on the recycling and utilization of plastics from the disassembly of used electric and electronic equipment. The recycling rates or utilization quotas as given in the WEEE represent high requirements. In our opinion, these recycling rates will be difficult to achieve without a sophisticated utilization of plastic wastes.

Example:

Commitment of our Ministry of the Environment and Transport may be illustrated by a pilot experiment, by means of which it was confirmed that utilization of materials may be economically profitable, if manufacturers, disposal companies, and plastics processing companies interact in a reasonable manner. Under the scientific monitoring by the Fraunhofer Institute for Production Technology and Automation, Stuttgart, several recycling firms and the Bauknecht company, a manufacturer of washing machines, have joined in a network. The project was aimed at proving that plastics from the disassembly of used electronic equipment can be utilized in an economically profitable way and that this utilization certainly is capable of development.

It is proved by the pilot experiment that further use of plastics from the disassembly of used electric and electronic equipment in the production of new technical components for such equipment is technically feasible and economically possible. Plastic fractions recovered from electric equipment taken back by the manufacturers as well as from the disposal of used electric equipment from households may be applied as recycle for the production of new technical components. The sorting out of devices from a mix of different used electric and electronic equipment according to certain criteria (recycling and color categories) as practiced under the project has also demonstrated that the spreading of pollutants can nearly be excluded.

For polypropylene (PP) an exemplary process was developed. It ensures that the plastic material has the technical properties required for the production of the component selected and meets the economic efficiency required. These activities have clearly shown that for the utilization of materials to be successful, networks of the following partners have to be established:

- Equipment manufacturers
- Disassembly companies
- Processing companies

Technical execution of the pilot project was accompanied by scientific work. The approach was documented extensively. Thus, the measures taken have been incorporated in a quality assurance procedure that contains instructions for dismantling, the definition of sorts, the optimization of separation processes, and the

establishing of quality criteria together with cost statements. In this way, the results may be transferred at any time to other networks for the plastics of interest, i.e. polypropylene (PP), acrylonitrile-butadiene-styrene copolymer (ABS), polycarbonate (PC), polystyrene (PS). Meanwhile, this project has been transferred to industrial production.

Another example:

Regarding the definition of competition-oriented boundary conditions, the Ministry supports a process developed by the Forschungszentrum Karlsruhe for the recycling of pollutant-containing plastics from used electric and electronic equipment. This project focuses on the recovery of the plastics, their precise sorting, and the reuse of substances suited for this purpose. These include, for instance, phenol, copper, silver, and hydrogen bromide. Development concentrates on the construction of a mobile facility with a capacity of 3000 tons of used plastic per year. The plant will be conceived, constructed, and tested in a site-independent manner. The resulting mobile technology is to allow for a further treatment of the material in the vicinity of the dismantling companies so as to avoid long transport paths. Apart from the environmental aspect, it is aimed at contributing to keeping the disassembly of used electric and electronic equipment inexpensive, also for small and medium-sized enterprises. Further details on this project will be reported in detail today.

Conclusion:

Successful recycling of materials or further use of components will not only require far-reaching administrative recycling specifications, but an enhanced individual responsibility of the producers and a competition-oriented definition of boundary conditions. For the development of viable solutions in the plastics recycling sector, structures existing in the disposal sector and suited for a more efficient recycling of materials may be made use of. Developments may not only offer ecological and economic advantages, but also contribute to an integrated product policy. Apart from shredder technology, ecologically efficient processes may be applied for the recycling of the plastics PP, ABS, PC, and PS. These are processes that meet sustainability as well as social concerns, such as the generation and maintenance of jobs. Having this large variety of products that are made of plastics daily, there are a number of



possibilities of introducing production processes with a minimum consumption of resources.

I wish you a successful and interesting workshop.

Günther Albrecht

Ministry of the Environment and Transport

Baden-Wuerttemberg

# **Reclaim of End-of-Life Electrical and Electronic Products by automatic sorting and grinding**

Kai Kramer  
Electrocycling GmbH, Goslar Germany

## **Preamble**

Over 2 million tons of electrical and electronic equipment are taken out of operation each year in Germany alone. This electronic scrap includes goods from the industrial, commercial and private sectors, and consists of power supply equipment, electrical tools, household appliances and entertainment electronics, telephones and computers.

Although municipal landfills often fail to meet the requirements for the safe, long-term storage of hazardous materials, a large portion of electronic scrap still finds its way to these sites without being treated - a clear waste of valuable raw materials and dumping space. This not only contradicts the concept of resource conservation but also poses a danger to the environment in the long term. The resulting costs are impossible to predict.

Since the quantities of electronic scrap are expected to increase even further, new, industrial concepts are urgently needed for the recycling of electronic scrap.

## **Reclaim of Electronic Scrap**

In 1994 Electrocycling was founded by Alcatel SEL AG, Deutsche Telekom AG, Preussag AG and Siemens AG. After one year of construction Electrocycling puts an industrial recycling plant into operation in august 1995. The plant has a capacity to recycle 30.000 t of all kind of electronic scrap per year and is located in Lower Saxony in Goslar 80 km remote from Hannover.



Photo 1: Electrocycling plant

The range of activities of Electrocycling includes all the services required in the recycling of electronic scrap. Electric and electronic scrap is collected regionally, transported and recycled in line with technical requirements. The products recovered in the recycling process are returned to the economic cycle and the remaining waste is disposed in accordance with legal regulations. The knowledge gained from the recycling process is used to advise manufacturers on the design of recyclable products.

The primary market for the input material is Germany but other Europe countries, too. The market for the products which are extracted from the scrap is whole Europe and other afar countries.

The devices and equipment recycled by Electrocyling range from telephones to television sets and personal computers to computers and radio equipment which weigh up to several tons and are the size of huge cupboards.

## Recycling plant

The plant (Fig. 1) consists of five subsections: incoming material/storage, preliminary dismantling, picture tube processing, plastic shredding, and mechanical processing. These are all located in a single building. The entire Operation is dry. Appliances are delivered by truck and normally handled with cage pallets or standardised containers. A part of the storage area has been set up for bulk material storage for incoming delivery of material in bulk form. Appliances are already sorted and coverage in a data system. The containers would be signed with a bar-code. Then they are stored separately as the WEEE demand in the incoming delivery area.

### Delivery of electronic scrap

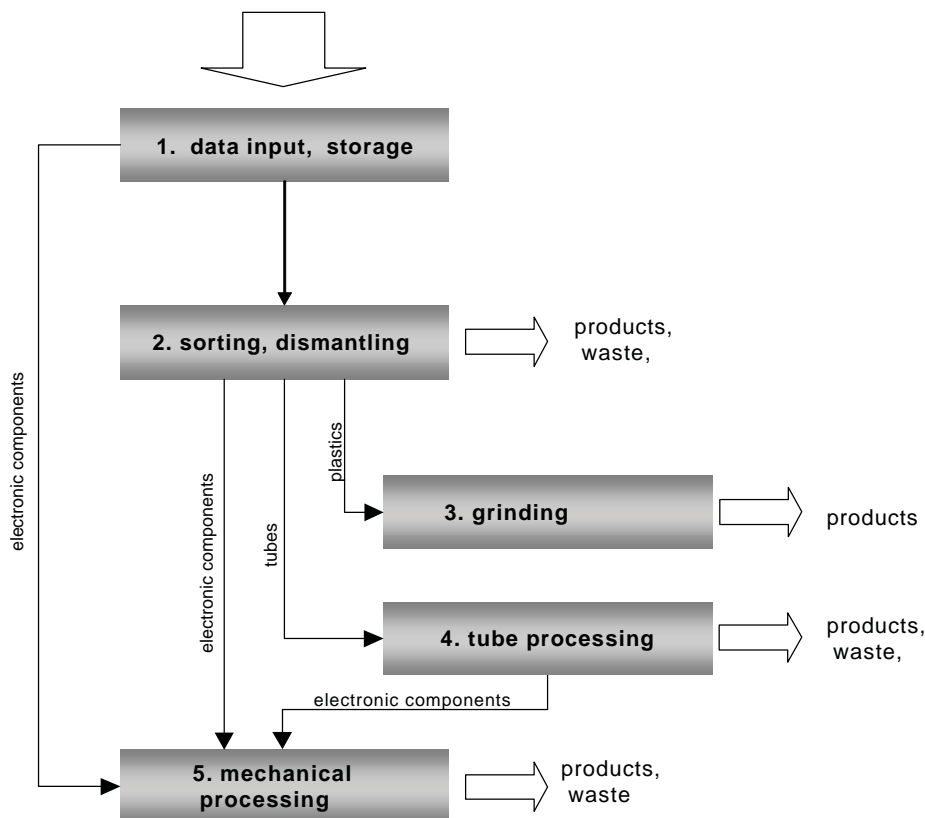

Figure: 1: Basic flow sheet

The appliances are then fed direct from storage to different manual dismantling lines: Dismantling line for light appliances (up to approx. 5 kg), for appliances of medium size (up to approx. 50 kg), display screens (TV/computer) and heavy appliances (up to 200 kg).

Manual dismantling as the first process stage has three main tasks:

1. Removal of the following components and assemblies containing hazardous materials:
  - PCB containing capacitors
  - Mercury containing components, such as switches
  - Batteries
  - Toner cartridges, liquid and pasty, as well as colour toner
  - Cathode ray tubes
  - Gas discharge lamps
  - Liquid crystal displays back-lighted with gas discharge lamps
2. Disassembly and removal of components or severing parts of housings which are to be treated separately (plastics etc.)
3. Removing reusable components for use as spare parts.



Photo 2: Dismantling



Photo 3: Dismantling

Mainly used for manual dismantling are conventional tools driven pneumatically or electrically such as chisel, tongs, screwdriver etc.

Dismantling is arranged in lines on which both transport to and from the line and also equipment Operation (rotating, tilting) can take place with mechanical aid and a suitable tool configuration is available. The aim of the implementation of specially equipped dismantling lines is to achieve a high productivity for the required dismantling work.

Heavy appliances are dismantled at workplaces equipped with vertically adjustable tables and special lifting devices. Products obtained from dismantling are conveyed (belt conveyors) to the subsequent process steps or are collected in Containers, which are emptied when required.

Cathode ray tube processing (Photo 4) entails a separation of screen and cone glass, metal separation and removal of the screen coating.

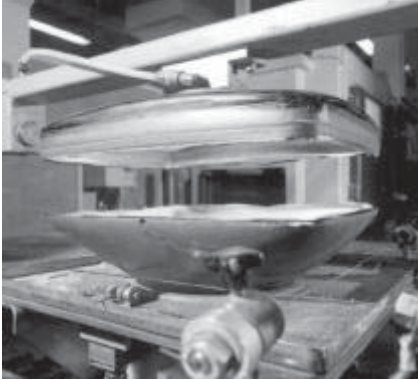

Photo 4: Cathode ray tube processing



Photo 5: ABS-plastics

Segregated plastics waste is shredded in a rotary cutting mill (Photo 5). This is required for subsequent processing and also serves to increase compactness for storage. A metal detector is connected downline to the mill to ensure a material free of metal. Metals are detected here and removed automatically. The segregated product is filled into big bags.

The components free from pollutants are then mechanically treated so that even very small particles of composite materials consisting of metal and plastics can be separated and sorted.

The processing layout (Fig. 2) contains a 3-stage liberation using a shredder for maximum piece sizes of 1000 x 800 x 800 mm and also two hammer mills for feed piece size from 60 to 200 mm and 5 mm respectively.

Iron is separated using overhead magnets. The concept for NF separation includes the use of eddy current separation in particle size range from 5 to 200 mm and separation on air tables for particle size ranges 5-10 mm, 2-5 mm and < 2 mm.

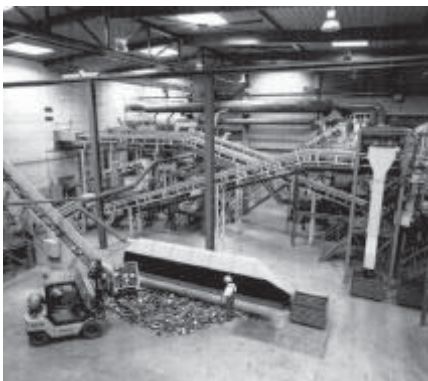

Photo 6: Mechanical processing



Photo 7: NF-separation

The Electrocyling GmbH plant in Goslar can handle a wide range of appliances, but also specifically kinds of telecommunication scrap, printed circuit boards etc. Options for operating with internal cycles in the separation stages after the 2nd and 3rd comminution stage have been included for that purpose. In addition, it is also possible to separate large liberated plastic pieces. The weighted product distribution is dependent on the composition of the feed material. On average, the following values can be assumed for the process

Fe	50 % by mass
NF	30 % by mass
Mixed plastics and filter dust	20 % by mass

The mixed plastics and the filter dust gained during the mechanical treatment are sending to incineration plants for energy recovery or to gasification plants for raw material recovery.

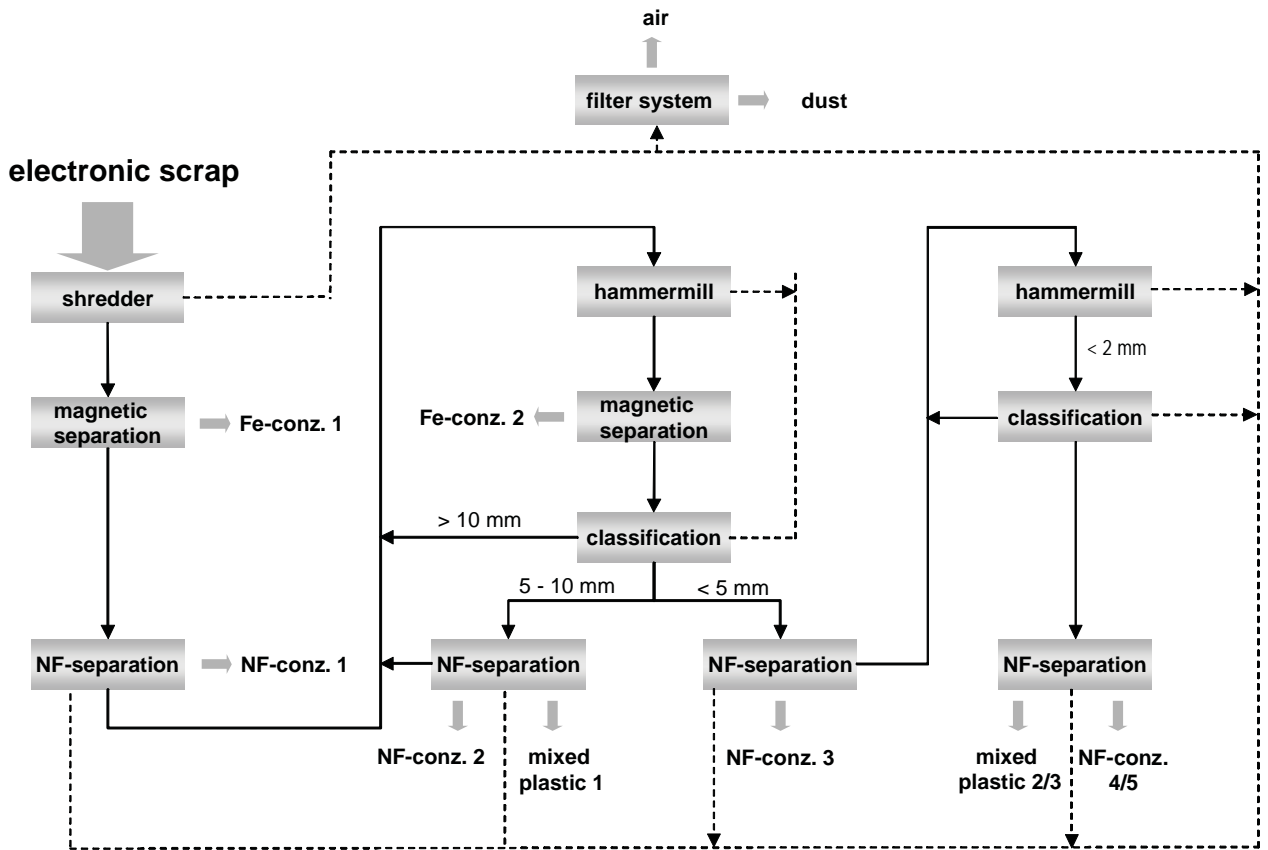

Figure: 2: Mechanical processing flow chart

## Sales

Electrocyling GmbH sells functional components recovered during the recycling process as spare parts for common electronic products or for the production of new devices.

The complex processes for the recovery of valuable substances guarantee very high degrees of purity. The metals recovered during these processes are sold to iron works and the non-ferrous industry as secondary raw materials.

Cleaned and separated picture-tube glass is used in the production of new picture tubes and other glass products. The lead containing funnel glass can also be forwarded to metallurgical processes



Photo 6: copper concentrate No. 4



Photo 7: Mixed plastics No. 1

Plastics sorted according to type are also used in industry. Deutsche Telekom AG, one of our shareholders, for example, has already produced casings for telephones and telephone cards from plastics recovered by Electrocyling.

### **Recycling out of a sense of responsibility for the future**

Recycling is not an inexpensive form of waste disposal but a way to use our resources sensibly and to preserve the environment. In comparison with primary ore electronic scrap is a very valuable material. To produce one ton of copper out of primary ore around thousand tons of rock have to be removed. To produce one ton of copper out of electronic scrap only around 14 t of old electronic equipment has to be collected and treated. Under comparable environmental and social conditions copper production by recycling is much more economical as by raw material mining.

**Electrocyling GmbH**  
**Landstraße 91**  
**38644 Goslar**  
**Telefon: 05321/3367-0**  
**Fax: 05321/3367-11**  
**Internet: <http://www.electrocyling.de>**  
**e-mail: [info@electrocyling.de](mailto:info@electrocyling.de)**

# Haloclean/Pydra – Thermal-Chemical Recycling of WEEE

Andreas Hornung\*, Susanne Donner, Wolfgang Koch, Jochen Schöner, Helmut Seifert  
Forschungszentrum Karlsruhe, ITC-TAB, Germany

## Abstract

In the context of a European project - "Halocleanapplication" - a dual-stage thermal-chemical treatment pilot plant of two gas tight rotary kilns has been developed to transfer halogen containing materials like WEEE into "clean" fuels and residues for noble metal recovery.

In this work the process parameter, temperature and residence time were optimised. The temperature has been varied between 250 °C and 550 °C. The residence time was changed between one hour and four hours. The bromine content of all products was determined and correlated with the different temperatures. The content of the pyrolysis oil was specified by GC-MS. In particular the changes of bromine components in the pyrolysis oil were investigated.

## Introduction

Plastics in electrical devices are equipped with different additives like phosphates, brominated compounds, chlorinated substances or antimony oxides in order to suppress the evolution of flames and the development of heat in case of fire.

However, especially brominated flame retardants are creating problems when electronic and electrical equipment reach end of life. If landfilled, toxic brominated flame retardants may slowly leach out into the ground water, where they persist for several years or they can be evolved into the air. If waste materials are burned toxic polybrominated dioxins and furans can be formed [1,2].

Although phosphates are replacing more and more brominated additives there is still a wide range of manufacturers around the world using them. So waste will continue to contain these substances. At the moment there are two main possibilities for the recycling of those bromine containing electrical devices. On the one hand some devices are mechanically dismantled, on the other hand metal rich fractions are treated in the copper smelters where copper and noble metals are regained. Anyhow, on the background of the European directive for waste electrical and electronic equipment started at 13.02.2003 in the future recycling rates of 50 or 75 % are required depending on the type of waste [3]. Hence, an innovative technology to come along with bromine containing electrical devices is required. That is why a European project of 10 European partners from industries, universities and research centers developed a process called " Haloclean "pyrolysis procedure. To separate brominated additives from inert and valuable materials in electronic scrap the pyrolysis process Haloclean has been examined.

---

\* Corresponding author, email: [Andreas.Hornung@itc-tab.fzk.de](mailto:Andreas.Hornung@itc-tab.fzk.de)



## Process Concept

The Haloclean process recovers electronic scrap in order to obtain halogen free fuels and a residue for noble metal recovery.

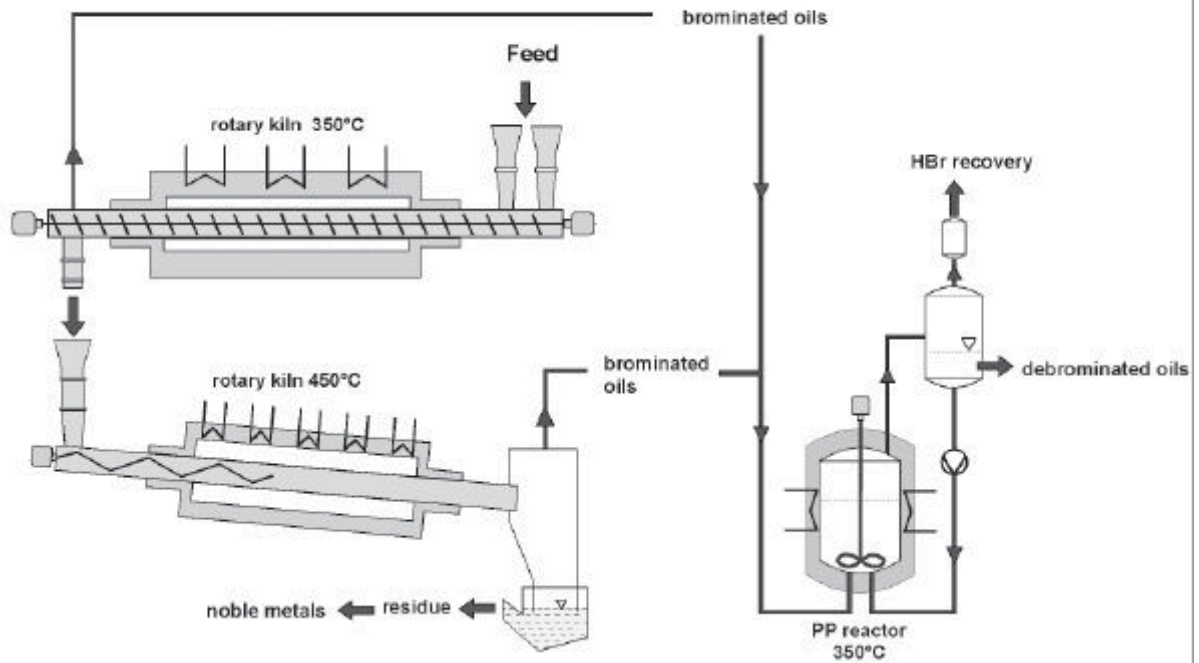

**Fig 1: Staged pyrolysis of electronic scrap.**

The electronic scrap is shredded into pieces of about 25 mm size and mixed with stainless steel spheres which allow for a good heat transfer and grinding of the material. Then the material is transported into a first reactor. The reactor operates at a temperature level of 300 to 400 °C. It is very important that the volatile products are able to leave the reactor immediately. The typical characteristics of the oil produced in the first reactor are dependant on the feed used.

The material and spheres are then transported into a second reactor operating at a temperature level of 400 to 550 °C. Again different oils occur depending on the feed material used.

Using melted polypropylene as a source for hydrogen the oils from both steps can then be dehalogenated and hydrogen bromide is obtained. Due to the fact that electronic scrap consists of a mixture of different polymers the oils will not be useful for recycling plastic, but it is possible to use them for methanol synthesis.

The next step is the separation of residues, spheres and the additives. As the residue is non tacky and dry different fractions can be gained by mechanical treatment. The metal containing fraction can be used in electrolysis to regain precious metals.

For the Haloclean process it is absolutely necessary that both temperature and residence time in the different reactors are exactly adjusted. The reason is not primarily the degree of conversion but the reduction and minimization of the content of brominated dioxins and furans in the residue. Furthermore, an optimal heat transfer to the feed and short residence times for volatile products to prevent secondary reactions are required.

## Haloclean Reactor [5]

The Haloclean reactor is an externally heated pilot-scale rotary-kiln pyrolyser (Fig 2).

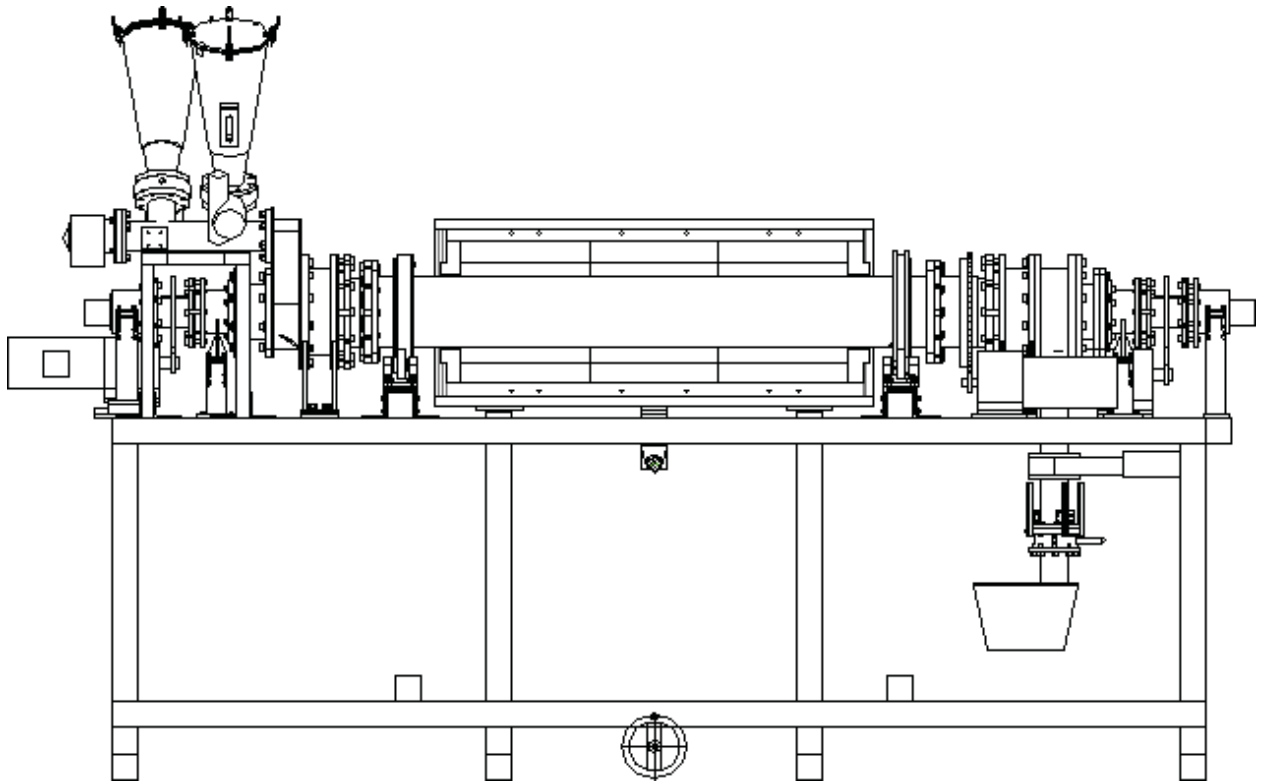

**Fig 2: Scheme of the Haloclean rotary kiln.**

In the kiln a screw for material transport and mixing is mounted. With the help of this screw the mean residence time in the reactor can be infinitely varied and adjusted exactly. The shaft of the screw is hollow and equipped with approximately 200 sinter metal plates. Through these plates gas can stream into the reactor. Therefore, a good transport of volatile products out of the reactor is given. In the inner core of the screw two heating tubes are installed for preheating the gas before flowing into the reactor and the reactor is heated not only from outside but also from inside.

It is possible to drive the screw forwards and backwards for a good mixing of the material. The three zones of the oven can be driven separately and on both sides gas can be let in.

## The Haloclean & Pydra Plant

Figure 3 shows the schematic view of the Haloclean plant realised at the Forschungszentrum Karlsruhe GmbH, Institut für Technische Chemie - Thermische Abfallbehandlung. The Haloclean reactor is situated right next to the PYDRA, a standard pyrolysis rotary kiln. Therefore, it is possible to use an existing burner and other installations and the infrastructure.

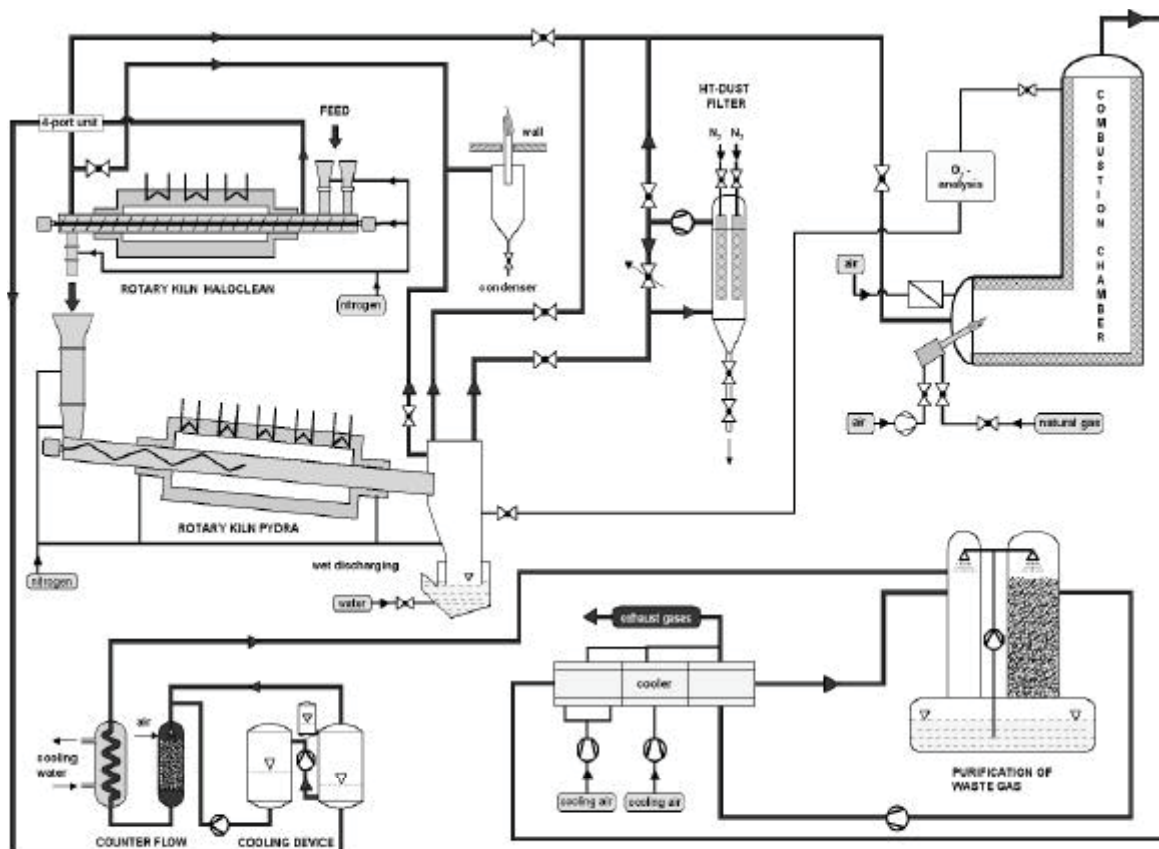

**Fig 3: Schematic view of the Haloclean plant**

The pyrolysis gases of PYDRA and Haloclean can be burned in a combustion chamber or cooled down with a cooling device. Both pyrolysis oils can be cooled or burned. After the burning chamber there are some purification devices for waste gases. There is also the possibility to condense small amount of pyrolysis oil for off-line analysis.

Both rotary-kilns are pressure controlled. When pressure will be too high a valve will open and the pyrolysis gases will cooled down by a condenser. The remaining gaseous fraction will be burned outright with help of a security flame. With the PYDRA rotary kiln it is also possible to test filtration of the pyrolysis gas at high temperature.

### **Debromination by Polymers**

Corresponding observations were aimed at finding out, whether a new type of reaction between polymers and brominated compounds in an inert atmosphere at temperatures ranging from 300 to 500 °C can be used to achieve an efficient debromination with useful hydrogen bromide as well as other substances being generated for reuse. In this temperature range, the polymer acts as a source of hydrogen and small alkyl radicals, while the inert gas ensures that the polymer does not oxidize rapidly. In literature it is reported that alkanes may act as hydrogen donor towards flame retardants (6, 7). But also polypropylene was observed to act in this manner when pyrolyzing a mixture of polypropylene and polystyrene (8, 9). In principle, using the polymer as a reductant of brominated organics corresponds to the working mechanism of brominated flame retardants under the influence of heat. Indeed, the reaction steps in oxygen have to be deleted only (Figs. 4 and 5), meaning that the debromination has to be performed without the presence of oxygen under an inert atmosphere.

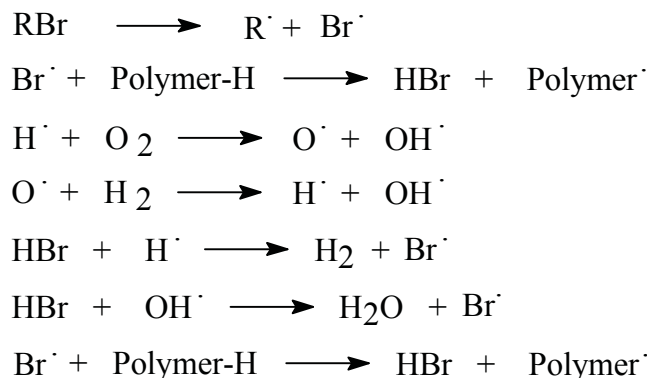

**Fig. 4. Reaction chain mechanism explaining the flame retarding process within polymers by brominated substances**

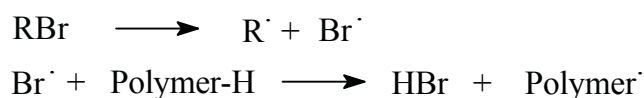

**Fig. 5. Mechanism for the destruction of toxic brominated organics**

To examine the above-mentioned reaction and its ability to destroy halogenated compounds, experiments with closed ampoules (10) were performed.

2,6-dibromophenol (Sigma-Aldrich), tetrabromobisphenol A (Sigma-Aldrich), pentabromodiphenyl ether (Sigma-Aldrich), 2,4-dichlorophenol, and an oil obtained from the Haloclean pyrolysis of printed-circuit boards were used as model samples. In addition to the main phenol product and other substituted phenols, the oil contained brominated aromatics, mainly bromophenol. Bromoalkanes were also present, but only in very small amounts. Syndiotactic polypropylene with the trade name Moplen HP500U,  $M_W = 121\,400$  g/mol,  $M_N = 37\,200$  g/mol (Basell) was used as reductant. The pellets were milled under liquid nitrogen in a cryogenic mill.

To analyze the reactivity of the different compounds, a glass ampoule was charged with the sample under nitrogen or helium atmosphere. To obtain a blind trial as a reference, nothing was added in one case. In a second ampoule, polypropylene was added to the brominated model compound at a ratio of 5:1 so as to reach total amount of about 80 to 100 mg. These ampoules were molten and then treated at a constant temperature in a preheated furnace. A temperature range of 350 to 400 °C and a residence time of 10 to 30 minutes were studied.

Afterwards, the ampoules were opened, the products extracted with acetone, and analyzed by GC/MS, HP 6890/5972A, using a dimethylsiloxane column, HP-1, of 60 meters length. The heat program was chosen as follows: 2 min at 70 °C, heating up to 290 °C with a heating rate of 10 °C/min, and then 40 min waiting time.

To analyze the gaseous pyrolysis products, the ampoules were broken in a closed tube that was furnished with a gas-tight septum and previously filled with helium. Gases were gathered from the tube by a gas syringe and then analyzed by GC/MS. The column used was the same than the one applied for the detection of the liquid products. However, the temperature program was varied: Starting from a temperature of -40 °C, an end temperature of 250 °C was reached with a heating rate of 10 °C/min.

## Results and Discussion

In the Haloclean rotary kiln different fractions of electronic scrap were tested and pyrolysed. One of these fractions was a fraction consisting of circuit boards from computers. This fraction had a gold content of 300 g/t and a bromine content of 5 % due to the brominated flame retardants.

This fraction was treated with temperatures between 250 and 400 °C and a residence time of one respectively two hours. After this first step the residue was cooled down and then again transported into the Haloclean rotary kiln and pyrolysed at 450 or 550 °C for 2 hours. The pyrolysis products, oil and residue, were analysed by means of GC-MS, RFA ... The organic components of the pyrolysis oil were found to be phenol mainly. The content of phenol and substituted phenols was up to 80 %. But there were also brominated compounds found in the oil, mostly being characterised as bromophenol and dibromophenol. In other words, the bromine content – quantified with the help of an oxidative decomposition followed by ion chromatography – after the second step was still too high to use the pyrolysis oil in further chemical processes like methanol synthesis or phenol recovery. A post-treatment with e.g. polypropylene is necessary.

Concerning the pyrolysis residue, it could be shown that after the two pyrolysis steps approximately 45% of the material remained in the residue independent of process temperature or process time. The concentration of bromine in the residue was nearly the same then in the feed whereas the gold concentration was twice as big as in the feed. In other words all gold could be found in the residue.

Pyrolysis of 2,6-dibromophenol produces different substituted phenols and phenol. Among the substituted derivatives are bromophenol, dibromophenol, and tribromophenol. Unfortunately, also brominated dioxins are formed by a consecutive reaction between two aromatic species (11).

The treatment with polypropylene can inhibit or even prevent the formation of these products. At least, they could no longer be detected by conventional GC/MS without further treatment of the sample. Apart from polypropylene, the main products are phenol and alkylated phenols. It may be assumed that ortho- and para-substituted brominated phenols have built up an unstable cyclohexadienone structure which may generate bromine radicals at a temperature of 250 °C already (12). Bromine then is scavenged from the polymer by hydrogen or alkyl radicals. In this way, brominated compounds are destroyed under the influence of the polymer. The most effective temperature to achieve debromination is 350 °C after a residence time of 20 minutes. Compared to other polymers like polyethylene, polypropylene seems to be the stronger agent, because of the lower energy of the carbon hydrogen bond at the tertiary carbon atom (Fig. 6).

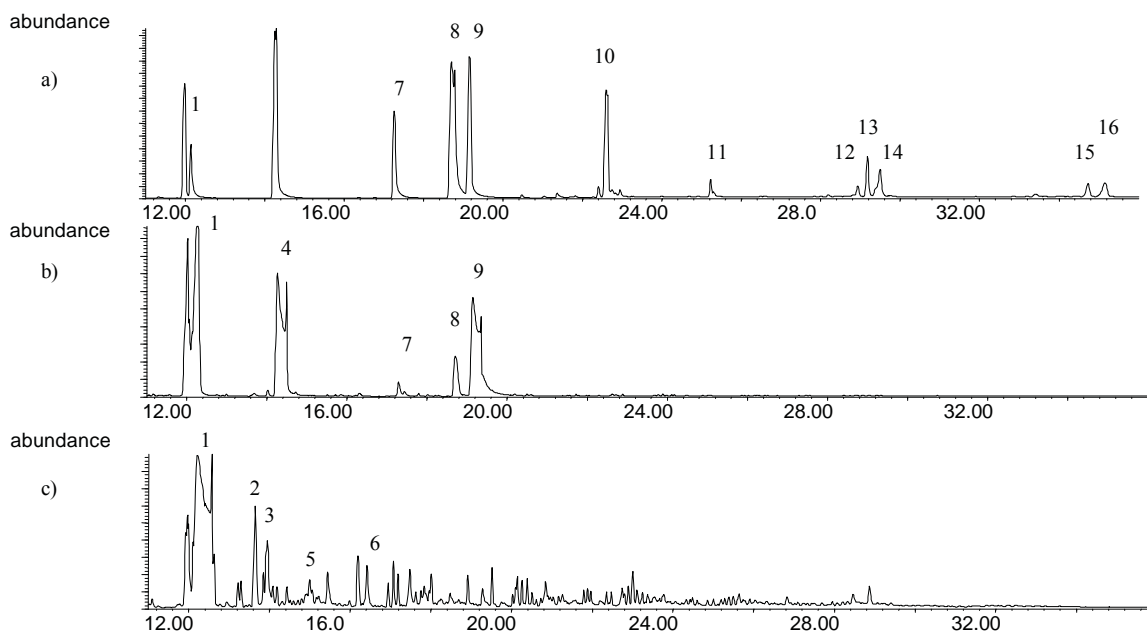
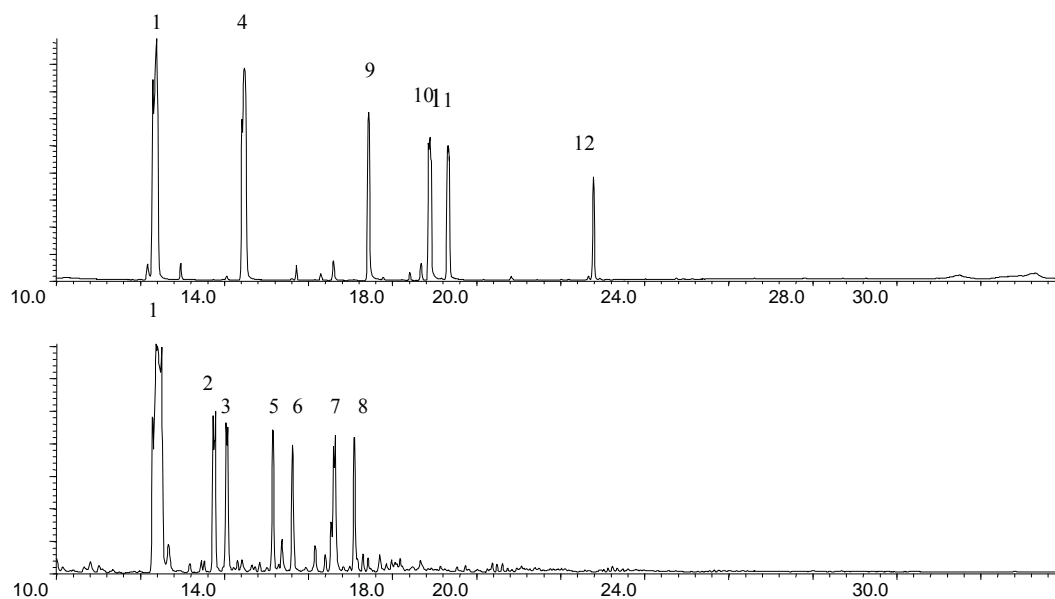

**Fig. 6. Treatment of 2,6-dibromophenol in a closed ampoule with and without polymer under an inert atmosphere at 350 °C for 20 min**

**a) dibromophenol at 350 °C for 20 minutes, b) dibromophenol with PE at 350 °C for 20 minutes products from extraction with acetone: 1) phenol, 2) 2-methylphenol, 3) 4-methylphenol, 4) 2-bromophenol, 5) 2-ethylphenol, 6) 2-isopropylphenol, 7) 4-bromophenol, 8) 2,4-dibromophenol, 9) 2,6-dibromophenol, 10) 2,4,6-tribromophenol, 11) bromodibenzodioxin, 12) - 14) dibromodibenzodioxins, 15), 16) tribromodibenzodioxins**

By the reaction with dibromophenol, polypropylene produces a black and waxy residue. The FT-IR spectrum shows the formation of double bonds within the polymer chain. This is confirmed by a characteristic absorption at  $971\text{ cm}^{-1}$ , which is abundant in the original polypropylene. In addition, the IR spectra exhibit absorption bands at 1604, 1509, 831, and  $758\text{ cm}^{-1}$  standing for aromatic structures.

Debromination of TBBA shows similar results. Polypropylene debrominates the organic pyrolysis products, whereby alkylated aromatics are produced (Fig. 7).

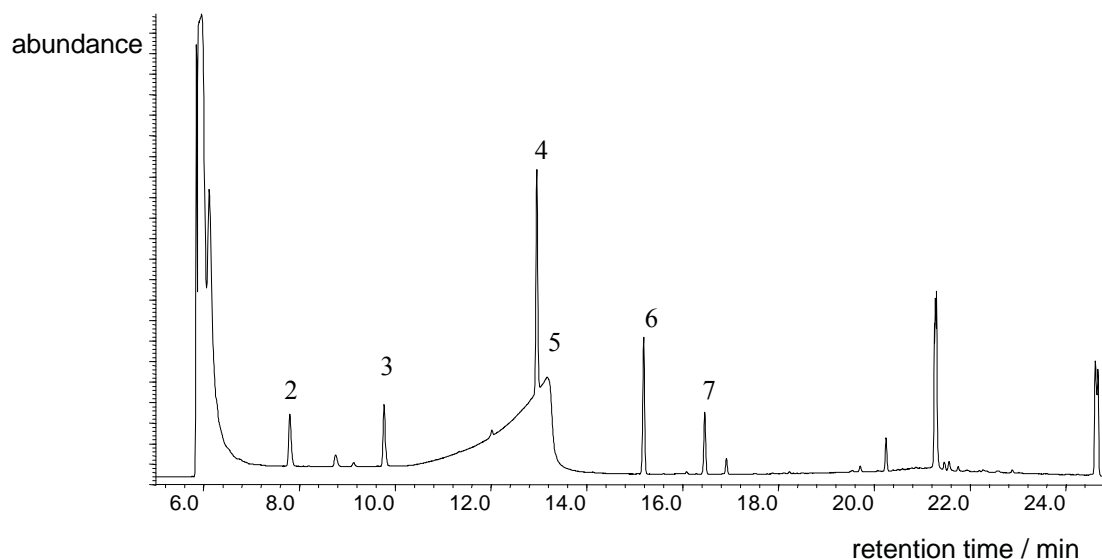

**Fig. 7. Treatment of tetrabromobisphenol A in a closed ampoule with and without polypropylene under an inert atmosphere at 350 °C for 20 min**

**a) TBBA at 350 °C for 20 minutes, b) TBBA with polypropylene at 350 °C for 20 minutes**

**products from extraction with acetone: 1: phenol, 2: 2-methylphenol, 3: 4-methylphenol, 4: 2-bromophenol, 5: 2-ethylphenol, 6: 4-ethylphenol, 7: 2-isopropylphenol, 8: 4-isopropylphenol, 9: 4-bromophenol, 10: 2,4-dibromophenol, 11: 2-ethylphenol, 12: 2,4,6-tribromophenol**

The gas phase shows in particular the evolution of hydrogen bromide and methyl bromide by the hydrogen and alkyl transfer reaction between polypropylene and the brominated compound (Fig. 8).



**Fig. 8. Gas phase composition during the reaction of polypropylene with TBBA**

**1: HBr, 2: 2-methylpropane, 3: methylbromide, 4: pentane, 5: H<sub>2</sub>O, 6: 2-methylpentane, 7: 2-bromo-2-methylpropane**

It is expected that also chlorinated compounds can be destroyed in the same way, as radical reactions are not known to be very selective. But astonishingly, dichlorophenol does not react with polypropylene under the same reaction conditions. And even at 500 °C, only slight dechlorination is observed. After a reaction time of 15 min, dichlorophenol still is the main product (Fig. 9).

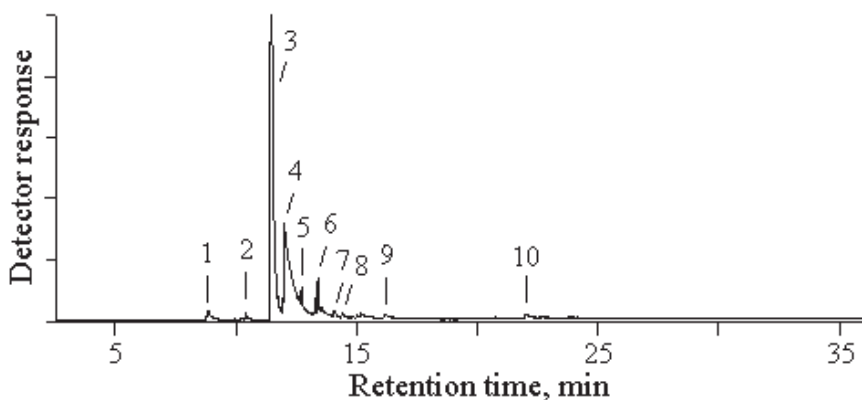
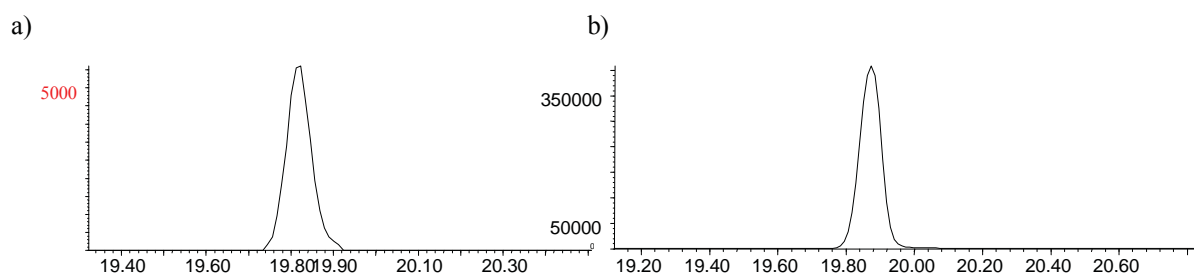

**Fig. 9.** Treatment of 2,4-dichlorophenol in a closed ampoule with polypropylene under an inert atmosphere at 500 °C for 20 min

1: o-chlorophenol, 2:- unknown, 3: 2,4-dichlorophenol, 4: p-chlorophenol, 5: 2,4-dichloromethylphenol, 6: 5-chloro-2-methylbenzofuran, 7: 2,4-dichloroethylphenol, 8: 5,7-dichlorobenzofuran, 9: 5,7-dichloro-2-methylbenzofuran, 10: 2,7-dichlorodibenzodioxin

The only explanation for this unforeseen result is that the halogenated reactant determines the reaction. This means that the cleavage of the halogen-carbon bond is rate-determining.

To examine the reaction also with a mixture of compounds, pyrolysis oil is applied. Brominated alkanes disappear after the reaction at 350 °C and a time of twenty minutes. Also dibromophenol can no longer be detected by GC/MS. The most frequent brominated compound in the oil is bromophenol. Also this substance decreases by a factor of 76 when comparing the peak areas of the main molecular masses of both experiments (Fig. 10).



**Fig.10.** Comparison of the peak areas of bromophenol (selected ion mode) a) after treatment with polypropylene and b) without treatment

Anyhow, polypropylene's ability to debrominate still remains to be evaluated for real pyrolysis oils as far as the debromination of brominated organics other than brominated



phenols is concerned. Regarding the phenols, decontamination capacity has been demonstrated by ampoule experiments.

### **Conclusion**

The directive on WEEE of the European community makes it necessary to recycle electronic scrap in the future. The Haloclean process – a complex system of different rotary kilns - is the first process which allows for a chemical treatment of electronic scrap and therefore the first process which gets along with the problems due to the high bromine content of electronic scrap. It could be shown that electronic scrap can be converted into gaseous hydrogen bromine, a nearly debrominated oil and a residue, that contains the noble metals in a more concentrated form. All three fractions are suitable for further usage.

Furthermore, debromination with the help of polypropylene is a promising reaction pathway that achieves a very effective debromination for several brominated aromatics tested at a reaction temperature of 350 °C under an estimated pressure of about ten bars.

As the corresponding chlorinated substances withstand these reaction conditions, the reaction could lead to a new process of regaining hydrogen bromide and small brominated alkanes from bromine-containing organic wastes. The optimized reaction conditions for such a process still remain to be developed, the aims being to examine parameters like temperature range, pressure, contact time between both reactants, and reactivity of different substances.

### **Acknowledgement**

The authors are grateful for financial support by the European Community for the Halocleanapplication project (G1RD-CT-2002-03014).

### **Literature**

- [1] Thoma H, Hutzinger O. Pyrolysis and GC/MS-analysis of brominated flame retardants in on-line operation. *Chemosphere* 1989; 18, 1047–1050.
- [2] Vehlow J, Bergfeldt B, Hunsinger H, Jay K, Mark F E, Tange L, Drohmann D, Fisch H. Recycling of bromine from plastics containing brominated flame retardants in state-of-the-art combustion facilities. Technical Report from APME. Brussels, 2001
- [3] *Elektronik* 4/2003, 40-44
- [4] A. M. Li, et al, *J. Anal. Appl. Pyrolysis* 50 (1999) 149-162
- [5] European Patent Application, No 00830831.4, filed on 19.12.2000, in the name of Sea Marconi Technologies di Wander Tumiatti Sas
- [6] Borojovich, E. J. C., Aizenshtat, Z., “Thermal behaviour of brominated and polybrominated compounds I: closed vessel conditions”, *J. Anal. Appl. Pyr.*, (2002), 63, 105 – 128.
- [7] Borojovich, E. J. C., Aizenshtat, Z., “Thermal behaviour of brominated and polybrominated compounds II: pyroproducts of brominated phenols as mechanistic tools”, *J. Anal. Appl. Pyr.*, (2002), 63, 129 – 145.
- [8] Bockhorn, H., Hentschel, J., Hornung, A., Hornung, U., “Environmental engineering: Stepwise pyrolysis of plastic waste”, *Chemical Engineering Science*, (1999), 54, 3043 – 3051.
- [9] Wong, H.-W., Broadbelt, L. J., “Tertiary resource recovery from waste polymers via pyrolysis: Neat and binary reactions of polypropylene and polystyrene”, *Ind. Eng. Chem. Res.*, (2000), 40, 4716 – 4723.
- [10] Hornung, A., Balabanovich, A. I., Donner, S., Seifert, H., “Detoxification of brominated pyrolysis oils”, *J. Anal. Appl. Pyr.*, in press.

[11] Balabanovich, A. I., Hornung, A., Luda, M. P., Camino, G., "On the mechanism of 2,4-dibromophenol pyrolysis", Chemosphere, submitted.

[12] Wang, C.-S., Lin, Y.-S., Fritz, D.-B., "m-Bromphenolic epoxy resins for electronic packaging", Die Angewandte Makromolekulare Chemie, (1992); 198, 51 - 60.

---

[i] Thoma H, Hutzinger O. Pyrolysis and GC/MS-analysis of brominated flame retardants in on-line operation. Chemosphere 1989; 18, 1047–1050.

[ii] Vehlow J, Bergfeldt B, Hunsinger H, Jay K, Mark F E, Tange L, Drohmann D, Fisch H. Recycling of bromine from plastics containing brominated flame retardants in state-of-the-art combustion facilities. Technical Report from APME. Brussels, 2001

[iii] Elektronik 4/2003, 40-44

[iv] A. M. Li, et al, J. Anal. Appl. Pyrolysis 50 (1999) 149-162

[v] European Patent Application, No 00830831.4, filed on 19.12.2000, in the name of Sea Marconi Technologies di Wander Tumiatti Sas

# Plastics from E&E waste - Innovative separation and upgrading technology

Patrick van Schijndel and Han van Kasteren

Kunststoffenhuis, Eindhoven University of Technologie, PO Box 513, 5600 MB Eindhoven,  
The Netherlands, phone +31 402473197, Fax +3140247 5430,

Email: P.P.A.J.v.Schijndel@tue.nl

## Abstract

The use of plastics in electronic and electrical equipment is increasing rapidly. Besides plastics, steel and glass these products also contain toxic compounds e.g. CFC's, flame retardants and heavy metals like mercury, copper, cadmium and lead. These components will leak into the environment when E&E products discarded are not treated in the right way. For this reason the Dutch government set up rules regarding the collection of different types of E&E products. Collected products are being dismantled and shredded in order to reclaim hazardous materials like CFC's but also useful materials like ferro and non-ferro metals. The plastic fraction is seen as waste and is incinerated or landfilled. The objective of the project described here is to develop an environmentally sound recycling process for plastics from consumer electronics, which cleans the plastics not only from unwanted additives but also upgrades their material performance

## Introduction

Of all plastics applied in products in Europe about 7% is used in E&E equipment. Figure 1 shows the European plastic consumption for E&E between 1992 and 2000, with a prediction for 2005. The Figure clearly shows the increasing consumption of plastics over the years. This increase is caused by a) increasing sales of E&E equipment and b) an increase in the plastic content of these products (on average 15 wt% in 1980 to 20% in 2000). This increasing plastic consumption for E&E also leads to increased E&E waste plastic streams, shown in Figure 2. Although discarded consumer electronics are a large source of plastic currently these are not recycled on a large-scale<sup>1</sup>. One major obstacle is that these plastics often contain additives (e.g. heavy metals and brominated compounds) that make them unusable for manufacturers. Moreover it is believed that, even if the additives can be removed, degradation of the polymers during their use results in poor material performance. The EU Directive on Waste from Electrical and Electronic Equipment (WEEE) communicates that the European Community must improve collection rates and minimum levels of material recovery drastically before the end of 2005<sup>2</sup>.

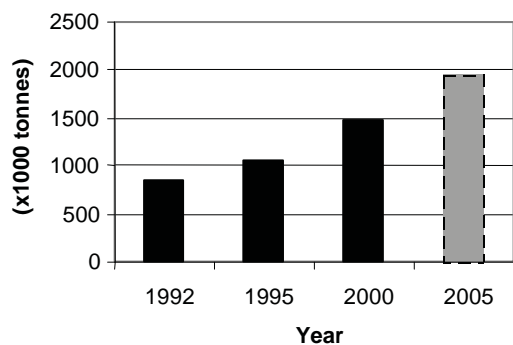

Figure 1. Plastic consumption for E&E Equipment (excl. cables and electrical eq.) Western Europe<sup>1</sup>

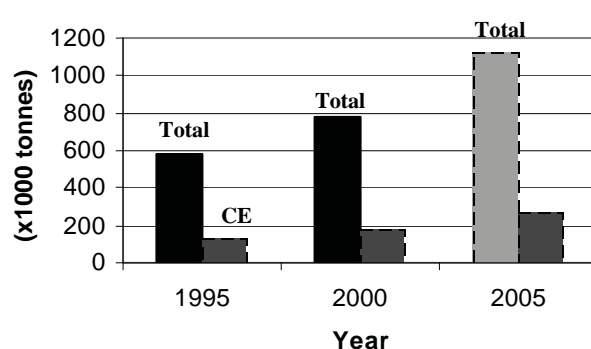

Figure 2. Waste plastic E&E equipment in Western Europe (Total and Consumer in Electronics, CE)<sup>1</sup>

According to the directive on the restriction of the use of certain hazardous substances in electrical and electronic equipment (ROHS)<sup>3</sup>, the use of heavy metals, i.e. lead, mercury, cadmium hexavalent, chromium and certain flame retardants i.e. polybrominated biphenyls, pentabromodiphenyl ether and octabromodiphenyl ether will be banned from future consumer electronic equipment in the EU. The use of deca bromodiphenyl ether (DBDE) is being evaluated by the EC. According to EBFRIIP it is not expected that DBDE will be banned in future<sup>4</sup>. Product designers have a task to phase out the substances. For recyclers this will mean new efforts to separate these substances from ‘old’ recycling streams. The objective of the project described here is to develop an environmentally sound recycling process for plastics from consumer electronics, which cleans the plastics not only from unwanted additives but also upgrades their material performance<sup>5</sup>.

### Heavy metal emission from consumer electronics

In the Netherlands the government funded IOP (Innovative Research) program sponsors research that is both scientific and has a large interest within society. Therefore several programs have been carried out focussing on environmental issues like pollution in the last ten years. This year marks the finalisation of the program on heavy metal emission from consumer electronics.

Consumer electronic products can be a burden to the environment in different stages of the life cycle. The use of fossil energy during the use stage is probably giving the largest contribution to these problems, followed by resource depletion and the dispersion of toxic and hazardous substances at the end-of-life stage of these products. Some of the heavy metals are seen as the most problematic pollutants in this stage. The use of metals and some specific heavy metals at this moment in time is still necessary to assure the functionality of consumer electronics. The development of alternatives for metals, e.g. lead on printed circuit boards and heavy metals in capacitors, is difficult from a technical point of view. Alternatives are mostly based on other metals, which only means a shift in problems. Furthermore, international competition makes investments in heavy metal free developments difficult if it is not accepted globally. Therefore it is more obvious to control the heavy metal flow within the framework of the current life cycle and to close the heavy metal cycle in an environmentally friendly and economical feasible way. Or to put it more popular: to solve the problems in the end-of-life stage of the CE and change the design where technically and economically possible in respect to the end-of-life stage collection and processing.

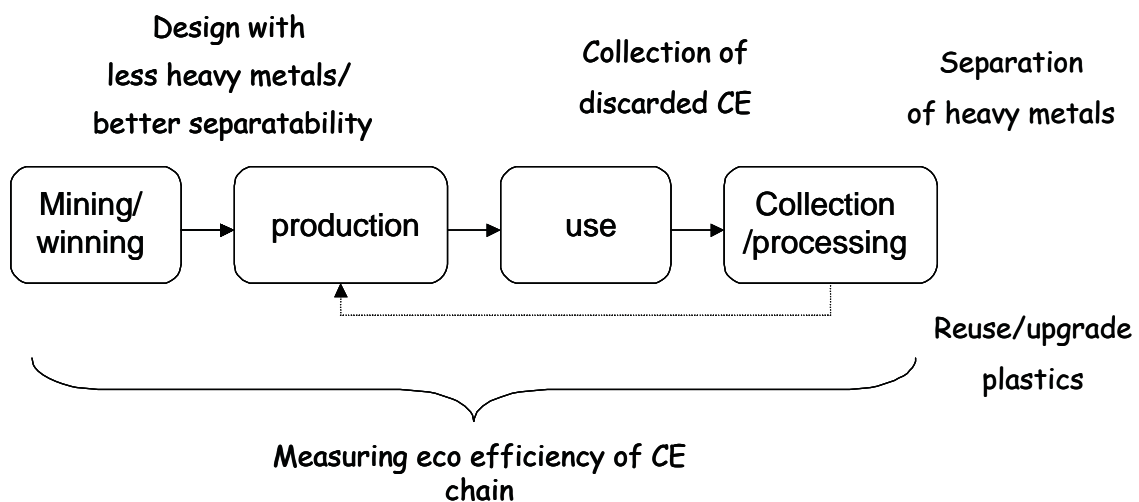

Figure 3. CE chain and different research areas within the IOP-CE program<sup>6</sup>

One of the objectives of this IOP project is to develop an environmentally sound recycling concept for plastics from consumer electronics, which cleans the plastics not only from heavy metals and unwanted additives but also upgrades their material performance<sup>5</sup>. Metals for which a solution in the recycling stage is difficult to find or not economically attractive should be avoided and thus it should be investigated how to design new CE with a focus on minimizing the life cycle heavy metal emission. The success of this approach depends heavily on the possibilities to collect discarded consumer electronics at the end-of-life stage. Therefore it is important to control the collection stage. One of the key issues there is consumer behaviour<sup>7</sup>. In order to adjudge the overall environmental effect of interventions it is crucial to have an instrument, which makes it possible to measure the overall eco efficiency of the CE chain. Such an instrument can also be used to generate suggestions for optimisation of different interventions<sup>8</sup>.

Several main solutions exist for the challenge of decreasing heavy metal emissions, namely (end-of-life improve and design improve):

1. Improving the end-of-life processes for CE:
  - a. Collection rates for (separate) discarded CE should be high (er)
  - b. Optimisation of shredding and separation processes in order to get the heavy metals in the right fraction
  - c. Optimisation of secondary streams within secondary material outlets (e.g. metal fractions optimised for smelters, glass fractions optimised for glass furnaces etc.)
2. Decrease the use of heavy metal containing components and additives in CE

Within the IOP CE project main focus lays in the end-of-life scenarios. This choice was made because it will be very difficult to phase out the use of heavy metals in components and additives. Furthermore the CE have a certain lifespan and it takes many years until these products are discarded.

The different research areas within the CE chain are shown in Figure 3. The paper continues with innovative options for recycling plastics from CE waste in the end-of-life phase.

### **Innovative recycling concepts**

At the start of the IOP project it has been recognized that for recycling plastics from CE equipment there are two possibilities:

1. First of all the plastics can be thermoplastic and containing low amounts of additives. Most likely these plastics can be recycled. However the quality of recyclates can be lower when compared to virgin materials. Therefore research has been focussed on upgrading these properties by addition of specific compounds during recycling
2. Secondly, plastics can contain high amount of additives like heavy metals. Most likely these additives have to be removed before they can be used again e.g. polyester type of plastics in printed circuit boards. Research in this area has focussed on a process of depolymerisation followed by separation of the additives from the monomers.

The combination of both upgrading/mechanical recycling and depolymerisation/separation routes forms a new proposed recycling scheme for consumer electronic plastic waste, as shown in Figure 4. Route *I*. shows the mechanical recycling route for the plastic waste containing low amount of hazardous additives, e.g. casings. Route *II*. Shows the route for depolymerisation of the thermo-set plastic matrix, e.g. printed circuit board, followed by separation of monomer and additives. Monomers can be reused or can be used for energy recovery. The additives can be separated into an organic and inorganic, e.g. heavy metals, fraction.

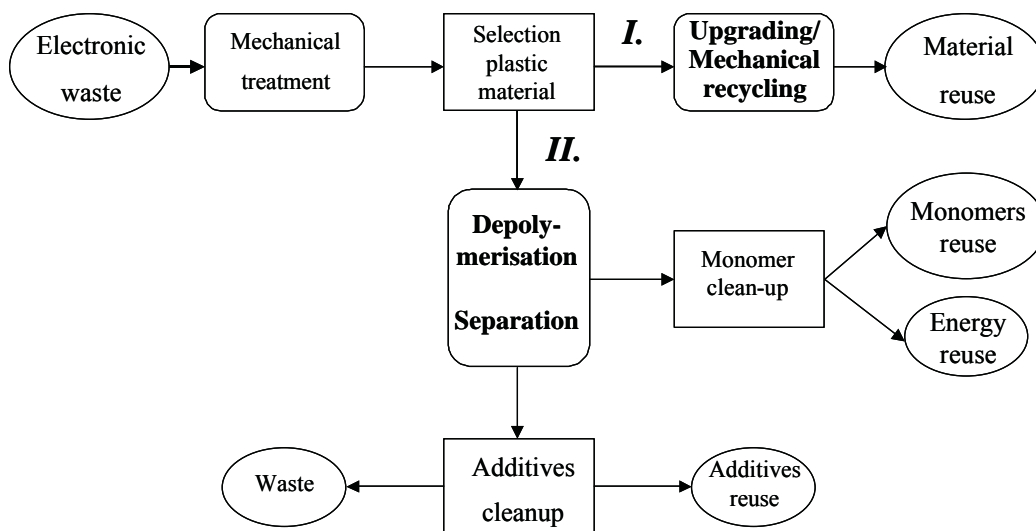

Figure 4. Recycling routes for consumer electronic plastics

### Depolymerisation and separation process

Additives like heavy metals are usually present in plastics in a very stable form. It is often difficult or even impossible to dissolve them and remove them by means of extraction. This has also been confirmed in our case by solubility tests. Therefore new ways and techniques for separation and purification have been considered. The objectives of our new approach are to depolymerise polyester plastics, e.g. polycarbonate, and to recover monomers in a (very) pure form. It is expected that separation of heavy metals will be a much easier task when the plastic is decomposed. By depolymerising the plastic, the monomer can be repolymerised to a new generation of plastic that has equal properties compared to virgin plastic. Successful repolymerisation is dependent on purity of reactants, so purification will play a very important role in this process. The monomers can also be used in other applications e.g. in different types of coatings.

A novel approach to separation is the use of supercritical fluids as solvents, e.g. carbon dioxide, to facilitate separation and purification. The advantage of using CO<sub>2</sub> as solvent is the opportunity to purify the monomer without elaborate and costly traditional separation and cleaning processes like distillation. Phase equilibrium experiments for mixtures of CO<sub>2</sub>, phenol and monomers bisphenol-A and diphenyl carbonate have been carried out using bubble point measurements<sup>9</sup>. The results show that it is possible to design a process for monomer separation using supercritical CO<sub>2</sub>. Experiments regarding depolymerisation of polycarbonate using phenol and catalyst have also been carried out and the results will be used for the overall conceptual process design. The conceptual design will provide us with an economic and environmental assessment, which will show the feasibility of this innovative recycling method.

### Mechanical recycling and upgrading process

For the plastics, which have a relatively low content of heavy metals, e.g. casings from TV's and monitors, depolymerisation is not necessary. As long as the plastics do not contain components according to EU-ROHS<sup>3</sup> mechanical recycling is a good and feasible option. In The Netherlands the collection of white and brown goods (consumer E&E equipment) is already being carried out for several years. This has increased the technical know how for separation of the plastics from other (metal) fractions. It is possible to reuse the plastics from old E&E equipment, mainly PS types of plastics into new products. In order to comply with

European legislation it is necessary to separate plastics containing (restricted) flame-retardants from flame-retardant free plastics. Mechanical recycling routes have been assessed and they seem to be feasible from both economical and environmental point of view

In case the mechanical properties of these recycled materials are not sufficient it is possible to upgrade these materials with the aid of siloxanes<sup>10</sup>. Figure 5 shows an example of mechanical impact test experiments for heat degraded ABS (11 weeks at 85°C) treated with diphenylsiloxanes. Smart combinations of recycled plastics with virgin polymers and additives like siloxanes can enable the reproduction of consumer electronic plastics parts from waste.

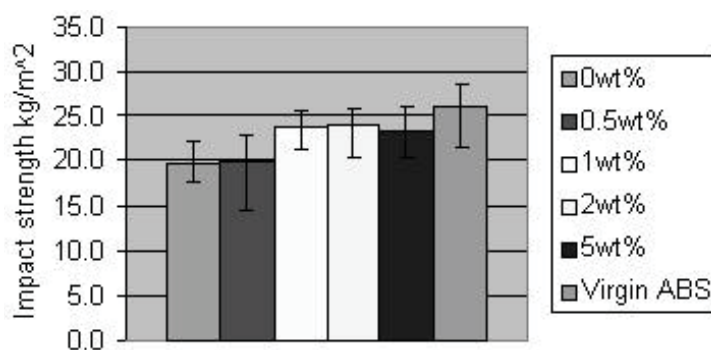

Figure 5. Influence of wt% diphenylsiloxane on impact strength of degraded ABS

## Conclusions

A new concept for the recycling of plastics from consumer electronics has been proposed. With this concept it appears possible to remove unwanted additives from the plastics like heavy metals and upgrade the polymer properties to virgin qualities. In this way resources are saved and emissions of additives to the environment are prevented contributing to sustainable development.

## Acknowledgement

The authors are grateful for the financial support of this project by the Dutch subsidiary research program of IOP/SENTER 'Heavy metals in consumer electronic plastics'.

## Literature

1. APME 2001, Plastics a material of innovation for the electrical and electronic industry – Insight into consumption and recovery in western Europe 2000, APME publication, summer 2001.
2. Directive 2002/96/ec of the European parliament and of the council of 27 January 2003 on waste electrical and electronic equipment (WEEE).
3. Directive 2002/95/ec of the European parliament and of the council of 27 January 2003 on the restriction of the use of certain hazardous substances in electrical and electronic equipment (ROHS).
4. EBFRIIP, European brominated flame retardant industry panel, official statement on December 12<sup>th</sup> 2002.
5. J.M.N. van Kasteren, P.P.A.J. van Schijndel, A.J. de Ron and A.L.N. Stevels Heavy metals in consumer electronics recycling, a multidisciplinary approach, , Int. J. of environm. Conscious design & manuf., 9 (2), 23-30, 2000.

6. Lex Lemmens and Patrick van Schijndel, IOP heavy metals in consumer electronics - Integration of research, IOP publication 2002 (copy can be requested from the authors).
7. F. Melissen, Designing collection rate enhancing measures for 'small' consumer electronics, PhD thesis, Eindhoven University of Technology, The Netherlands, 2003.
8. J. Huisman, The Qwerty/EE concept – Quantifying recyclability and eco-efficiency for End-of-life treatment of consumer electronic products, PhD thesis, TU Delft, The Netherlands, 2003.
9. G. de Wit, J. M. N. Kasteren, P. J. Lemstra V. Margon, U.S. Agarwal and C. J. Peters Phase equilibria of carbon dioxide with phenol and diphenyl carbonate, , accepted for publication in J. of Supercritical Fluids 2002.
10. R. Walgers, J.M.N. van Kasteren and P.J. Lemstra, Recycling and Upgrading of polystyrene from electronic scrap using siloxanes, Proceedings of the PPS Asia/Australia regional meeting 1999, 1-3 December, Bangkok, Thailand, 198-200, eds. J.L. White and K.S. Hyun.



# **Mobile Phone Recycling: Umicore's solution for the WEEE-directive**

Seppe Geerinck, Project Manager Umanage, Umicore

## **The challenges of new EU legislation**

### General

New European legislation on waste handling will bring into force regulations on the recycling of electronic devices and their accessories. European government is pushing the principle of "Producers Responsibility", resulting in specific obligations on the treatment of collected end-of-life devices.

Meeting these new regulations and requirements will be a challenge for both producers and recyclers. Existing recycling processes will have to be redesigned with additional technologies in order to have a full compliant recycling process.

Umicore has picked up this challenge to meet the obligations imposed on the mobile phone industry.

### Handset recycling

The new European Directive 2002/96/EC on Waste Electrical and Electronic Equipment (WEEE-directive), sets stringent recycling and recovery targets for such WEEE material. For ICT equipment, the recycling target is set at 65% and the recovery target at 75%. These targets have to be met by December 31<sup>st</sup> 2006.

Today several companies - Umicore being one of them - offer services in the recycling of electronic devices, including handsets. A major issue is that, to the best of our present knowledge, none of these companies, Umicore included, operate a process compliant with the future specific recycling target of 65% set by the WEEE directive.

Since a handset is composed of more than 50% plastics by weight and current recycling technologies typically burn these plastics, using them as a substitute for fuel (energy recovery - which is currently not accepted as recycling), the current recycling rate of a handset is +/- 45% by weight (according to WEEE definitions only metals and other inorganic materials can be counted as recycled).

The only way of complying with the 65% recycling target by the 31<sup>st</sup> of December 2006 is to recycle part of the plastics of the handset. Therefore, on top of the existing recycling technologies, additional processing will be necessary to separate the metal fraction from part of the plastic fraction, allowing further plastic recycling.

### Battery recycling

Three directives currently cover the management of spent batteries: 91/157/EEC, 93/86/EEC and 98/101/EC. These directives have been reviewed on Feb 28, 2003 and there is clearly an intention to strengthen the requirements.

In general, the European Commission aims to harmonise the national requirements concerning batteries and accumulators and their end-of-life management. The reviewed directive shall cover all types of batteries as well as the appliances in which they are incorporated.

At present, Member States aim to achieve no later than 31 December 2004 the following targets:

- For separate collection covering their whole territory: a minimum of 75% by weight of all spent consumer batteries
- For recycling: a minimum of 55% by weight recycling (excluding energy recovery). This target is likely to be increased in the future

Already many collection schemes and recycling technologies are in place for a number of batteries (i.e. lead, NiCd, button cells). However, to the best of our present knowledge, no company is currently able to “truly” recycle Li-ion batteries (beside NiMH used in the majority of portable electronic devices) in a technically and economically feasible way. These batteries are currently simply diluted into the flux of other battery types (mainly NiMH) or simply stockpiled until such technology is available. Increasing volumes of Li-ion batteries could render such “solutions” unsustainable in the future.

### The strategies in mobile phone recycling

#### Handset recycling

When an end-of-life mobile phone is collected, several options for further processing of the different components are available. Batteries, handsets and accessories are separated for further treatment. The first major part is the handset. See picture N° 1 for some of the processing options.

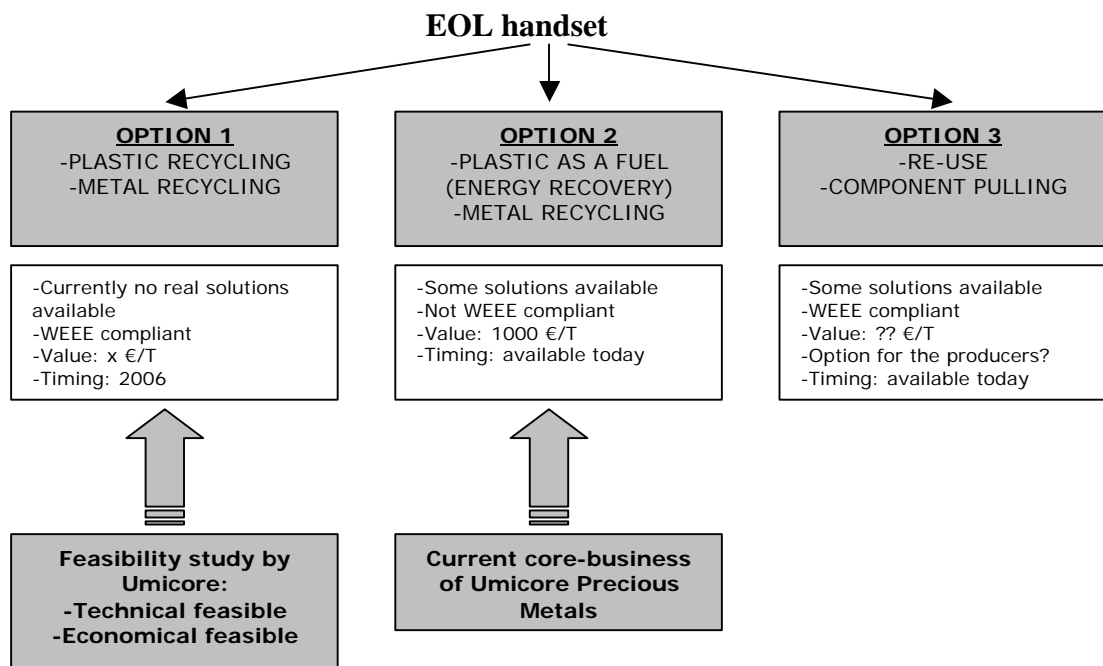

Picture 1: Processing options for handsets

As can be seen in Picture N°1, several options are possible for handset recycling. Option 2 is the current core-business of Umicore Precious Metals, a world leader in the recycling of electronic end-of-life materials. Since Umicore wants to offer the mobile phone industry a tailor made solution according to the requirements of legislators and those of the industry, the option of recycling according to the new WEEE directive was investigated with success.

#### Battery recycling

Also for the batteries, several recycling options are available. Batteries can be handed to national recycling schemes, sent directly to several recycling companies or simply stockpiled.

Umicore successfully pilot-tested the possibility of recycling advanced rechargeable batteries, namely the NiMH and Li-ion batteries found in portable electronic devices.

The uniqueness of Umicore's technology to recycle these types of batteries is the dedicated process, therefore not only being environmental sound and in compliance with new regulations, but also cost-efficient compared to other solutions.

#### Conclusion

Umicore has very valuable assets and knowledge to offer the mobile phone producers a tailor made solution according to their wishes and legal requirements. The optimal solution should although be in accordance with the strategies of the producers.

### **Umicore's current processes and services**

#### Handset recycling

The Precious Metals Business Unit, located at Hoboken Belgium, is the world market-leader for the recycling of precious metals-bearing complex materials. The plant's feedstock mainly consists on the one hand of recyclables, such as complex intermediate products and on the other hand of specific precious metals-bearing materials e.g. electronic equipment, including handsets.

All metals included in these materials are recycled using a unique metallurgical process ensuring first-class metal recycling yields (> 95%). More information on the technology can be found in flowsheet N° 1.

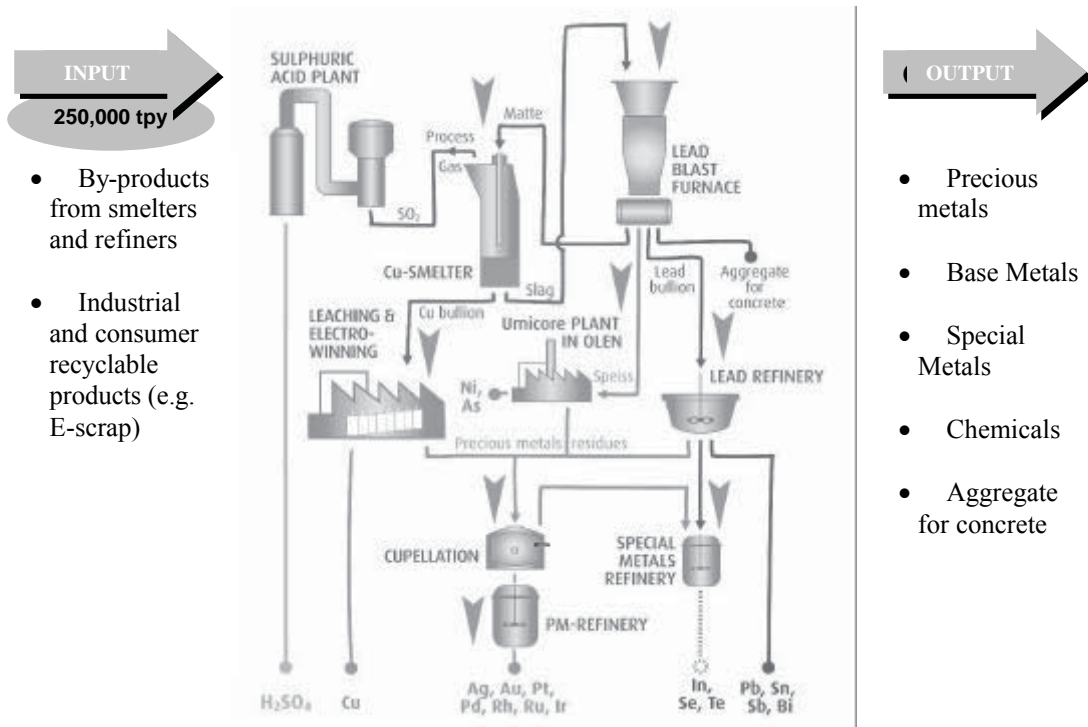

**Flowsheet 1: Umicore Precious Metals**

Using the above flowsheet, virtually all metals included in the handsets are recycled, maintaining the intrinsic value. All plastics of the electronic equipment are used as a fuel substitute in the Cu-Smelter where the energetic value of the plastics is used as thermal energy recovery.

On the field of environmental friendly recycling, gas cleaning and water treatment facilities embrace the metallurgical process. A typical illustration is the pyro-metallurgical flowsheet that guarantees dioxin-less processing of electronic devices.

In conclusion, Umicore has proven that it has one of the optimal technologies to recycle electronic devices like handsets in a cost-efficient and environmental friendly way, according to existing regulations.

**The refining of Cobalt/Nickel**

Umicore Advanced Materials, another Business Unit, is already producing more than 2000 ton per year of Nickel & Cobalt used e.g. in rechargeable batteries. Umicore Advanced Materials is also a leading supplier of both Cobalt-oxide and Lithium Cobaltite, some of the main constituents of Li-ion batteries.

Umicore possesses several Co-refineries world-wide. One of the bigger ones is the Co-1000 refinery in the Olen plant.

The Olen refinery can handle a range of Co-containing materials (both metallic as non-metallic). The capacity is 1200T Co/year. Nickel contained in the feed is bled to the nickel sulphate production.

The flowsheet starts with leaching the raw materials. The leaching step can take place in either sulphuric or hydrochloric acid, also leaching in an autoclave is possible. After the leaching there is a filtration step. The leach residue is either disposed of in a controlled way, or if it contains further valuable elements is kept for further recycling.

The purification of the Co-leach solution is done in two main steps. The first step is a hydro-metallurgical purification. Here mainly copper, iron and some related elements are removed.

As a second step a solvent extraction is used. Hereby a tailor-made organic absorbs impurities from the solution, which are later removed again from the organic. This is done in various steps for various elements to be removed.

The refining generates a waste stream, that is treated to comply with environmental rules, a nickel stream that is bled to the Olen nickel sulphate hexahydrate plant, and a stream of purified Co-solution, depending on the used acid for the washing a Co-chloride or a Co-sulphate solution.

The purified Co-solution is of high grade purity and is used in the production of the various cobalt end products made at the Olen plant (Co-oxides, Co metal powders, Co salts, ...)

## **Feasibility study on the required pre-processing technology**

### Introduction

Over the past 6 months, Umicore conducted a feasibility study on the required pre-processing of handsets and batteries. This study aimed at exploring different options in order to meet the new EU legislation on the recycling of complete mobile phones.

The feasibility study, managed by Umicore, was performed in co-operation with external research partners (e.g. universities, engineering companies, ...) who were chosen on the basis of a market study investigating their know-how, experience and references on the pre-processing of either handsets or batteries.

At the start of these studies, 5 major objectives were set:

- The requirements, set by WEEE, Battery and other relevant directives, had to be exceeded
- The total required flowsheet had to be economic
- It had to be a total solution for both handset, batteries and accessories
- The process had to be robust with proven technologies
- The pre-processing technology had to fit Umicore's operational assets

### Execution

First of all, a literature study on the available possibilities was conducted in order to find the first rough flowsheet. All advantages, disadvantages, limitations and opportunities were investigated, leading to a proposal to run pilot tests on the chosen technologies.

The pilot test programs were conducted using handsets obtained from producers and batteries obtained from collectors. In total more than 4T of handsets and 3T of batteries were used in more than 4 different technologies. After each test, samples were taken in order to analyse the content and further options were discussed.

At the end of all the different test programs, a full report was made up, including following items:

- Flowsheet and used technologies
- Different output fractions with their weight percentage
- Necessary operating and investment resources
- Flexibility of the process (options which need closer examination)
- Technological issues which need closer and more detailed investigation

Results: handsets and accessories

“The study, in close collaboration with Umicore, showed that a mechanical pre-processing to separate a substantial part of the plastics from the metals is feasible. The required overall recycling rate of 65% can be met at reasonable costs and negligible metal losses. Using the process developed in this study, the overall recycling rate can be varied in the range of about 66 to 76% by varying simple process parameters”

Prof. X, head of Raw Materials Technology, University Y

The different test programs showed that it is feasible to separate metals from plastics, after which the plastics can be recycled in the plastic industry (possibility of using different technologies) and the metals can be recycled at Umicore Precious Metals, hereby exceeding the WEEE requirements. This can be done in a cost-efficient and environmental friendly way.

All processes are based on mechanical separation, followed by chemical recycling for the plastics and metallurgical recycling for the metals. A simplified flowsheet (with the focus on the separation of plastics and metals) can be found in the flowsheet N° 2.

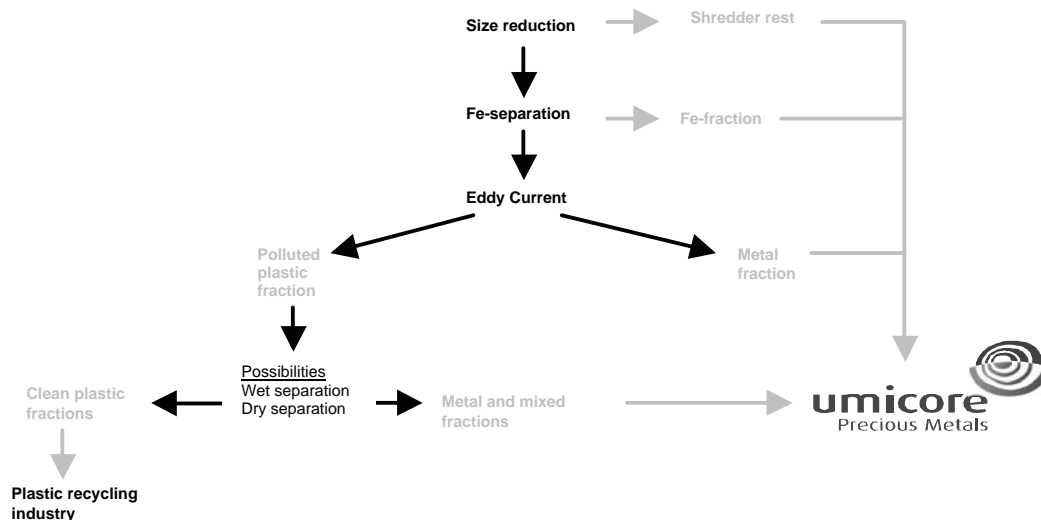

**Flowsheet 2: pre-processing handsets**

Although all test programs showed positive results, it has to be noted that the programs were only at the stage of pilot testing and several items on technology, economics, flexibility and concept need to be investigated in much greater depth before a final decision on investment can be made.

Results: batteries

An internal R&D team investigated and proved the possibility of a cost-efficient and environmentally sound technology to recycle NiMH and Li-ion batteries. Especially the recycling of Li-ion batteries is very unique since, to our knowledge, until today there doesn't exist a "true" recycling solution for these batteries.

The process is based on pyro-metallurgy pre-treatment followed by hydrometallurgy for the further refining of the metals. Virtually all metals are recycled while the plastics are used as energy recovery. Recycling rates of more than 70% were achieved during the test program. A simplified flowsheet (with the focus on pre-processing) can be found in flowsheet N° 3.

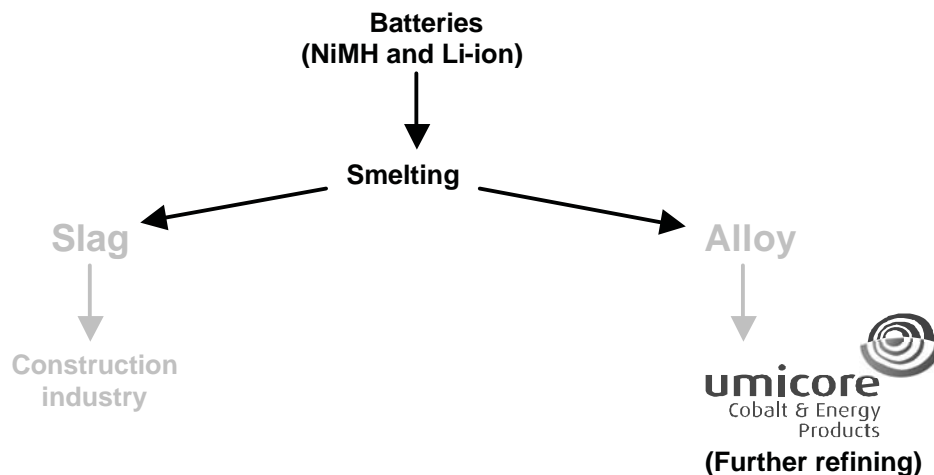

**Flowsheet 3: Recycling batteries**

Again, although the feasibility test program was successful, there are still a number of remaining issues and options, which have to be investigated more thoroughly before an investment decision can be taken.

## Conclusion

Umicore successfully tested a process to recycle complete mobile phones (batteries, chargers and accessories included) according to new EU-legislation (WEEE and Battery directive) with flexibility for future (more stringent) changes.

First financial calculations show that this one-stop-shop processing solution is not only price competitive but since all processing is done in-house, Umicore can offer full transparency in processing and reporting and a certified destruction of the mobile phones.

# DISPOSAL OF ELECTRONIC SCRAP IN BADEN-WÜRTTEMBERG : A LIFE-CYCLE VIEW ON FUTURE RECYCLING OPTIONS– OUTLINE OF A STUDY

Prof. Dr. L. Schebek

Department of Technology Induced Material Flows, Institute for Technical Chemistry  
Forschungszentrum Karlsruhe

---

## Abstract:

A number of changes in recycling of ‘electronic scrap’ is expected the next years. A study under way at the *Department of Technology Induced Material Flows* aims to assess different options in compliance with the WEEE-Directive. By use of Life Cycle Assessment (LCA) methods different combinations of processes across the recycling chain are analysed. The study is linked to the *Baden-Württemberg Regional Network* at regional level and to the *Haloclean-Project* at process level. The analysis varies in degree of detail and spatial reference from a general point of view to Baden-Württemberg reference and finally to a process specific scale. To simplify evaluation, streamlined approaches are chosen. The evaluation is based on the Cumulated Energy Demand (CED), backed up by a sensitivity analysis.

---

## Motivation and Usage

The initial interest in recycling of ‘electronic scrap’ was recovery of metals for sheer economic reasons. The relevance of substances like lead, brominated HC, or PCB has been well recognized and in meanwhile environmental aspects have become more and more an additional issue.

In foreseeable future the European Directive ‘Waste from Electrical and Electronic Equipment’ (WEEE) will have effects on established recycling structures. The proposed consequences are:

- Responsibilities will be shifted towards producers, who emphasise high cost-efficiency while full legal compliance [EUWID 42/02]. The revision of contracting might drive a re-organisation of the market.
- By introduction of recycling quotas the focus of waste management is extended from recovery of profitable metals and elimination of the most hazardous components to the whole range of materials applied in electrical and electronic appliances. Thus recycling techniques other than the conventional ones will be applicable.
- The latest official information about a possible national implementation of the European Directive states that local authorities should provide collection services in future [BMU][EUWID 14/03]. In particular, a first screening has shown for example, that hardly any local authority in Baden-Württemberg does right now have a collection scheme in place, which is fully consistent with the future regulations.

Comprising, a number of changes is to be expected in terms of legislation, collection schemes and responsibilities. Not only a re-organisation is required but also application of techniques other than the conventional ones. For certain categories of electronic equipment the treatment of polymeric materials is essential to take the hurdle set by the WEEE-Directive, as can be seen from Fig. 1.



### Embedded Research

The project Haloclean-Conversion started in 1999 with the objective to develop a process for conversion of polymers from waste electronic equipment, esp. flame retardant plastics. The present follow-up project HalocleanApplication aims to bring that process in practice.

The *Ministry of Traffic and the Environment Baden-Württemberg* set up a Regional Network of interested partners active in the range of collection, dismantling, recovery and recycling of WEEE.

A study under way at the *Department of Technology Induced Material Flows* is strongly linked to both, the Haloclean-Project and the Baden-Württemberg Regional Network. The focus is set to provide basic environmental and economic information on future options for recycling of WEEE.

What is the purpose of that study in practical terms? Some supporting information on the favourable recycling options in terms of the collection scheme or the treatment can be expected. Thus support and attention is paid by political and administrative authorities, e.g. namely the *Ministry of Traffic and the Environment Baden-Württemberg*. As for the Haloclean Project the verification of the mobile plant concept is one topic of interest as well as the integration in existing process chains.

### Objectives

The study strives not to examine single processes, but to picture the over all chain of processes for treatment of WEEE. The objective is set to provide essential information for determination of a favourable combination of parallel and sequencing processes for future treatment of disused electrical and electronic appliances commencing 2005. The stages considered are collection, transportation, disassembly, mechanical treatment up to final utilisation or disposal.

### Tackling the Task

A full Life Cycle Assessment considering all possible scenarios and impacts would exceed manageable efforts and an acceptable time span, thus simplifications are necessary. The proposed approach is threefold:

- At a general level relevant processes and material flows are identified (cf. Fig. 2). For example solvolysis is dropped, because there is no running plant on market. For legal reasons other processes will not be suitable for certain fractions, e.g. incineration.

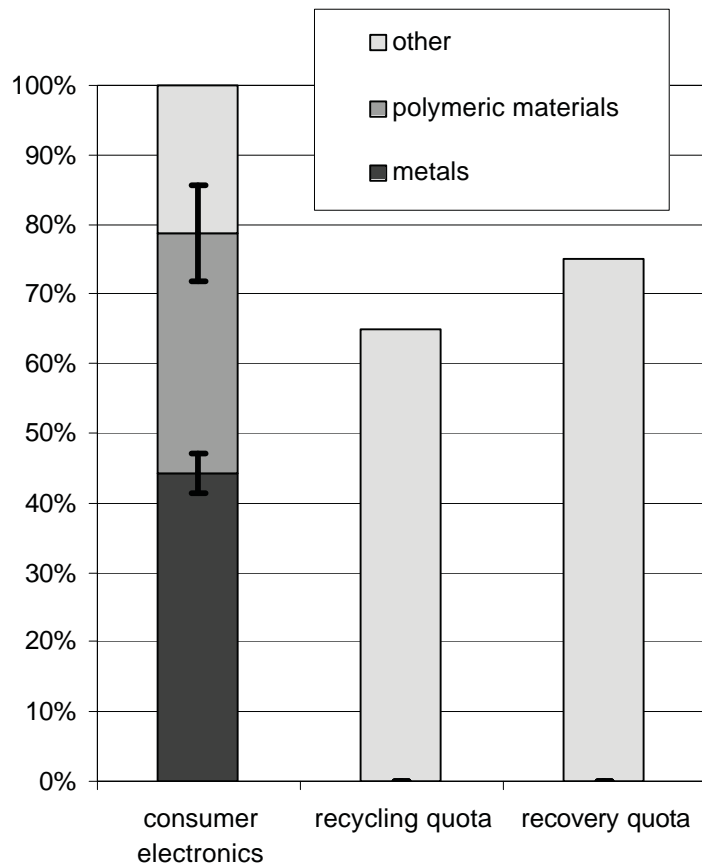

**Fig. 1 Consumer Electronics (w/o TV sets): recoverable materials and recycling/ recovery rates. Based on [LUA], [Töpfer], [WEEE-Directive].**

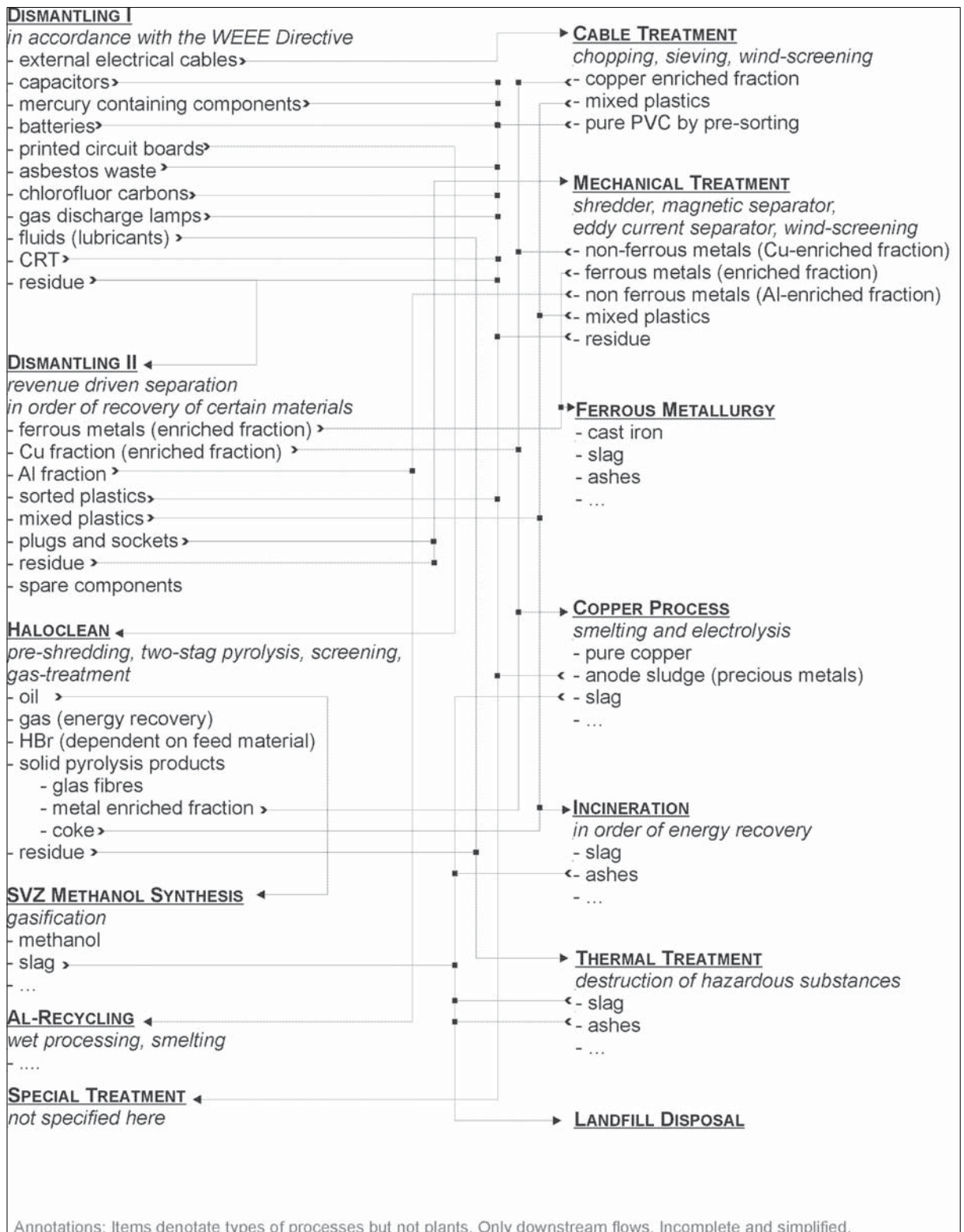

**Fig. 2: Treatment of Waste Electrical and Electronic Equipment. Simplified scheme on involved processes**

- At regional scale, certain topics are discussed by example of Baden-Württemberg:
  - Generally there are two approaches to **estimate future quantities** of ‘electronic scrap’. In a sequential way one could determine quantities of

purchase over past times, then identify the appliances span of usage and derive therefrom future quantities of waste. However as for this study a different approach is chosen. Influencing factors such as income, fees, population density etc. are identified and quantified. Supposing certain scenarios prospective statements can be given.

- **Collection and transportation** are investigated by example of two regions within Baden-Württemberg. Each one of them does apply either bring system or pick-up system for collecting ‘electronic scrap’. Efforts and captured quantities are compared.
- The third stage focuses on single processes: The Haloclean plant is analysed in detail and compared to alternatives. As for printed circuit boards, some special mechanical treatment in combination with copper smelting might be an competing option. **Dismantling and further treatment** for recovery or disposal are topics scheduled for next years tasks.

Although the three above stages do have different degree in detail and different spatial extension, they interrelate to single conclusions. For instance the following questions are to be answered:

- What are appropriate collection schemes: pick-up or bring system? What fractions should be kept separately while collection?
- What is the favourable degree of dismantling?
- How can the Haloclean-Process be integrated in the existing recycling chain? Where might feed materials come from? What are quantities of the feed materials?

### **Streamlined evaluation**

The different scenarios have to be evaluated. In LCA methodology this is usually done by impact categories, for example noise, resources depletion or acidification. A number of at least ten impact categories is to be considered, usually even more than fifteen [Schmitz].

Covering the whole chain of ‘electronics recycling’ the workscope is set quite wide, thus simplification is a matter of feasibility. The Cumulated Energy Demand (CED) will be utilised as leading indicator for environmental evaluation. Generally speaking, the CED pictures other impact indicators such as Global Warming Potential (GWP), Acidification Potential (AC), and resources depletion quite well [Giegrich][Weil]. As a single indicator CED is easy to interpret. As a further advantage, CED is nationally standardised [VDI 4600].

However CED is insufficient for matters like toxicity, stratospheric ozone depletion or land use. There is a need to review each CED evaluation whether there are neglected significant aspects. Anyhow CED is applicable to all three stages and thus will fit together to overall conclusions.

### **References**

- [BMU] Federal Environmental Ministry: Eckpunkte künftiger Rechtsvorschriften zu Elektro- und Elektronik-Altgeräten in Deutschland. (Release, April 2003)
- [EUWID 42/02] Europäischer Wirtschaftsdienst – Recycling und Entsorgung: „ZVEI: Einigung zur WEEE bietet Grundlage für praktikable Lösung“. Issue 42/2002, p. 2
- [EUWID 14/03] Europäischer Wirtschaftsdienst – Recycling und Entsorgung: „Trittin: Bei Altgeräten geteilte Verantwortung“. Issue 14/2003, p. 29
- [Giegrich] Giegrich, J.; Fehrenbach, H.; Knappe, F.; Detzel, A.; Kröger, K.: Bewertung der Umweltverträglichkeit von Entsorgungsoptionen. Study conducted by ifeu GmbH (Heidelberg, 2002) on behalf of the Ministry of Transport and the Environment BaWü. Reihe Abfall, Heft 63

- [Jenseit] Jenseit, W.; Lützkendorf, T.; Eiermann, O.: Der Kumulierte Energieaufwand (KEA) im Baubereich. Arbeitspapier im Rahmen des UBA-F&E Vorhabens 10401123. Publisher: Öko-Institut, Darmstadt (1999)
- [LUA] Holst, H.: Aufkommen und Zusammensetzung von Elektro- und Elektronikgeräten. In: Verwertung von Elektro- und Elektronikaltgeräten. Hrsg.: Landesumweltamt Nordrhein-Westfalen. Materialien Nr. 3 (Essen, 1994)
- [Schmitz] Schmitz, S.; Paulini, I.: Bewertung in Ökobilanzen. UBA Texte 92/99. Publisher: Umweltbundesamt (Berlin, 1999)
- [Töpfer] Töpfer, P.: Elektronikschrott Entsorgung/ Recycling. Studie im Auftrag der Impuls-Stiftung (1993)
- [VDI 4600] N.N.: Kumulierter Energieaufwand - Begriffe, Definitionen, Berechnungsmethoden. VDI-Richtlinie 4600 (1997)
- [WEEE-Directive] Directive 2002/96/EC of the European Parliament and of the Council on waste electrical and electronic equipment (WEEE) of Jan. 27<sup>th</sup> 2003. Published OJ L 37 (2003)
- [Weil] Weil, M.; Jeske, U.; Schebek, L.: The ecological positioning of concrete with recycled aggregates – First results of an LCA and material flow analysis. Joint SETAC Europe and ISIE meeting 2-4 December 2002, Barcelona, Spain. 10<sup>th</sup> LCA Case Studies Symposium “Recycling, close-loop economy, secondary resources”

# LCA EXPERIENCE IN THE FIELD OF RECYCLING OF PLASTICS FROM ELECTRONIC WASTE

B. DeBenedetti<sup>1</sup>, L. Maffia<sup>1</sup>, G.L. Baldo<sup>2</sup>

<sup>1</sup> Dipartimento di Scienza dei Materiali ed Ingegneria Chimica, Politecnico di Torino, Italy  
e-mail: debene@polito.it

<sup>2</sup> Life Cycle Engineering, Torino, Italy

KEY WORDS: LCA, electronic waste, plastic recycling

## ABSTRACT

Conservative estimates of world population and economy growth foresee a doubling of figures by the year 2050. This development will cause a dramatic rise in the demand for complex industrial products, in particular electronics and cars, accompanied by an increase in the consumption of natural resources as well as impacts to the environment in a life-cycle perspective. From this point of view, the goal of a sustainable development can be reached by a life-cycle thinking approach, according to a vision in which a product should be designed taking into account all its five life cycle phases: pre-production (raw material extraction phase), component manufacturing (production phase), distribution/transport phase, use phase and end of life scenarios. At this is the goal of the WEEE Directive, in force from the beginning of 2003, for which end of life of products assumes a strategic position in a life-cycle context especially for products with a limited life-span (Electrics&Electronics). This paper focuses on plastics recycling from E&E waste, that through the comparison of some technologies by a Life Cycle Assessment (LCA) point of view.

## INTRODUCTION

Manufacturing of electronic and electric equipments (E&E) is one of the fastest growing industries and the amount of E&E waste has increased to about 6 million tons per year in the European Union at the end of last century with an estimated increment of 3-5% per year (Figure 1).

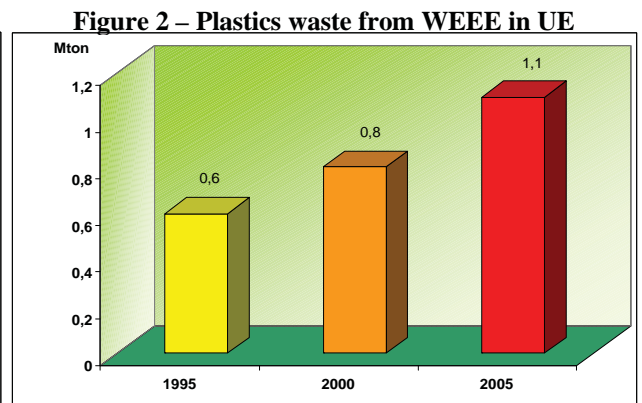
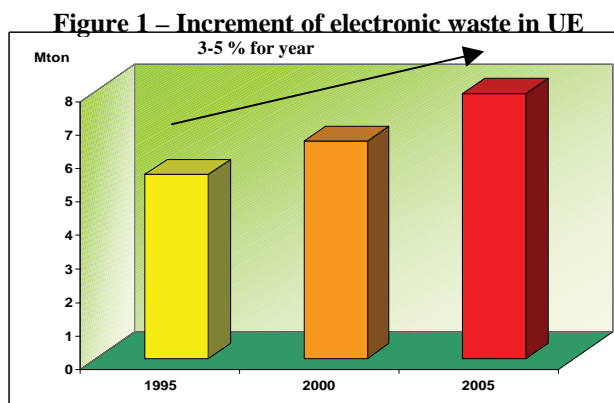

In the E&E sector, plastics have become a key to innovation and they are increasingly the material selected for brand new products: in 1980 plastics made up 15% by weight of all E&E and in 2000 this quantity had risen to 20%. As the amount of electronic waste grows, the amount of plastics waste increases too, as shown in Figure 2. For this reason, the WEEE Directive goals are to promote reuse, recycling and other forms of recovery of materials and to minimise the risks and impacts to the environment associated with the treatment and

disposal phases at the end of life of these equipments, with particular regard to plastics and metals.

At present, plastics recycling processes are critical since polymers for electronic applications often contain additives, such as heavy metals and flame retardants. Development of plastics with environmentally friendly additives is going on and the use of LCA approach is considered strategic in this area, where the methodology may be used to support management strategies with particular attention to the choice of alternative processes.

### **WEEE and LCA**

The purpose of the EU WEEE Directive (*Waste Electrical and Electronic Equipment – 2002/96/EC*), that entered into force on 27 January 2003, is, as a first priority, to improve the environmental performance of all operations involved in the life cycle management of these equipments, with particular attention to those operators directly involved in the end of life phase. In detail, as far as concern treatment technologies, member States shall ensure that, by 31 December 2006, the rate of recovery will be increased to a minimum of 70% by an average weight per appliance and component as well as materials and substances reuse and recycling shall be increased to a minimum of 50%. These objectives should promote an incentive to design and produce E&E equipments easier to be recovered and, in the meantime, to set up new processes to treat and recycle WEEE.

For these reasons, the LCA approach may be considered an important issue to plan design technologies both at manufacturing and at end of life treatment operations.

### **PLASTICS RECYCLING TECHNOLOGIES**

In general, plastics recycling technologies can be subdivided into three main categories: mechanical, chemical and energy recovery.

Mechanical recycling processes consist in material to material transformation and the techniques are based on mechanical and, if necessary, thermal treatments. Usually, starting from thermoplastic polymers, granulates suitable for manufacturing are obtained whereas thermosetting polymers are commonly milled to be used as inert filler for plastic materials. This recycling methodology is mainly adopted when plastic wastes are homogeneous.

Chemical recycling processes are based on wastes chemical transformation through which it is possible to obtain monomers suitable for plastic materials production. As far as this recycle method is concerned, the main available technologies are:

- pyrolysis;
- hydrogenation;
- gasification.

Energy recovery consists in the re-use of feedstock energy contained in wastes. Since plastics have a net heat value of about 35-40 MJ/kg, the recovery of this energy through combustion processes for civil and industrial aims is considered strategic.

In particular, as far as concern WEEE treatment, thermal processes are one of the most attractive approach of recycling enabling recovery of bromine, monomers and precious metals. However, plastics wastes from electrical and electronic equipment often contain heavy metals and brominated aromatics as fire retardants, therefore one of the most relevant drawback in dealing with thermal treatments of WEEE is the production of halogenated dibenzodioxins and dibenzofurans. Environmentally friendly fire retardant systems currently under developed to substitute halogen based systems and to move downward the content of halogen in forthcoming WEEE; however, waste now collected as well as those in the next future still contains a relatively large amount of brominated fire retardants. For this reason, many techniques commonly used for recycling, as mechanical recycling, foundry operations and incineration do not fit or are in conflict with the rising standards imposed by EU

Directive: at present, 90% of used electrical and electronic equipment is incinerated or landfilled without any pre-treatment.

**ENVIRONMENTAL LOAD OF DISPOSAL/RECYCLING TECHNOLOGIES**

Four different scenarios for waste routes from E&E equipment are going to be compared by means of life-cycle perspective, with the aim of calculating the environmental impacts associated with the treatment of 1 kg of electronic scrap: landfill disposal, incineration plant, Knudsen recycling process and Haloclean pyrolysis technology (Figure 3 and 4).

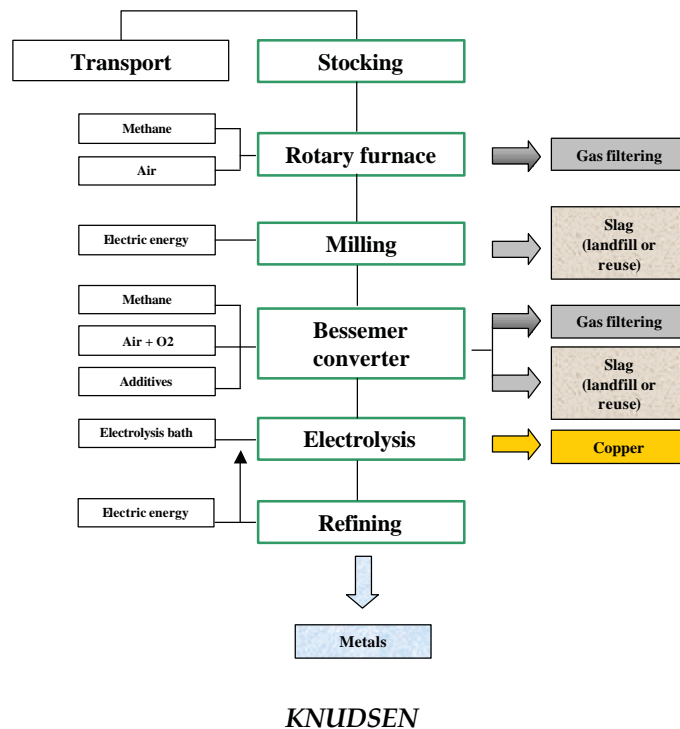
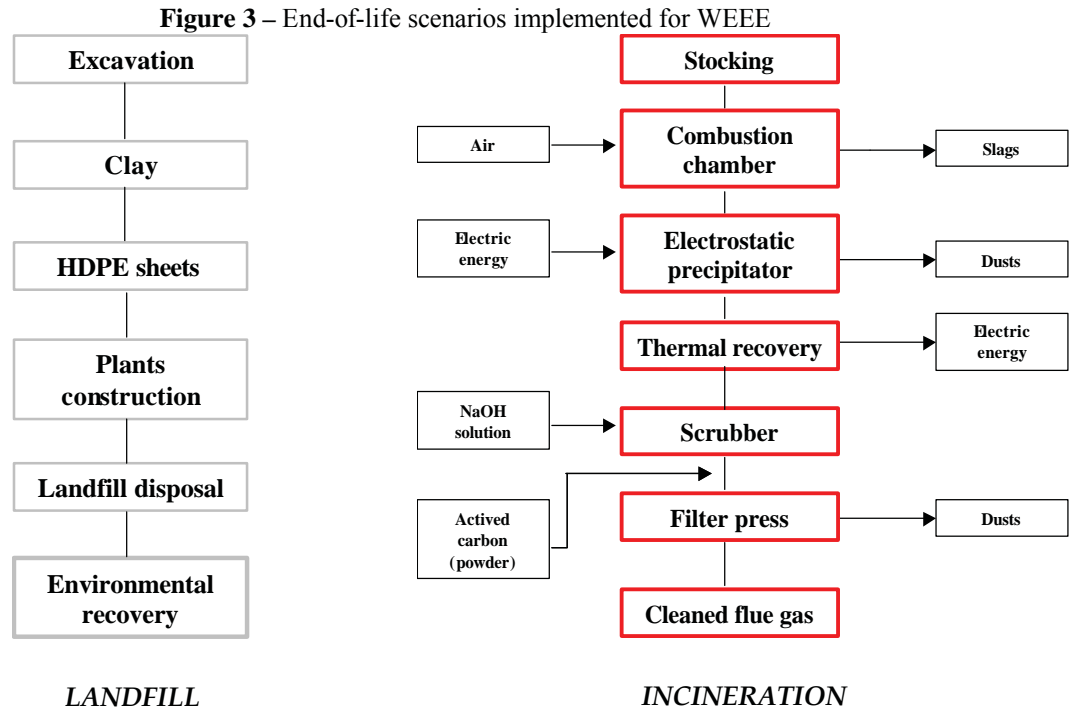

**Figure 4 – Model of pyrolysis process**

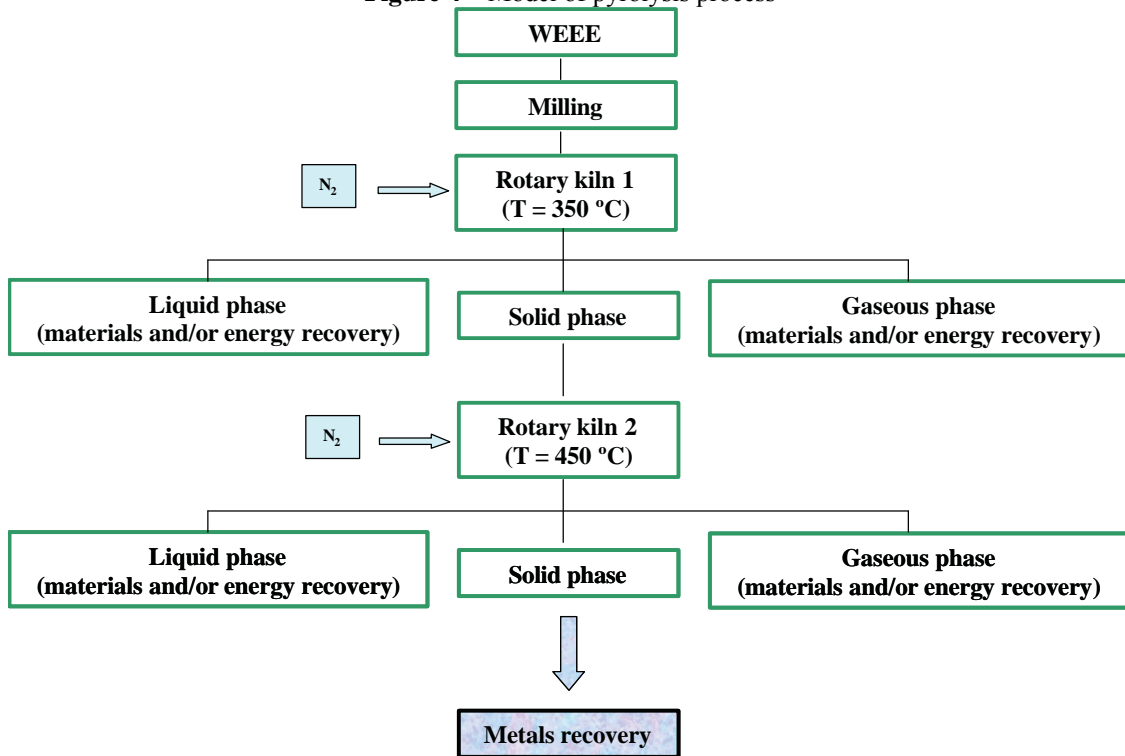

The information and data for the systems come from previous experiences and have been elaborated by means of the Boustead Model (version 4.4). About pyrolysis, the Inventory activity is still going on and results are still not available. In detail, data collection refers to Haloclean pilot plant that is performing in the context of the European Growth Project G1RD-CT-2002-03014.

Figure 5 shows the gross energy data associated with 1 kg of treated waste for the three scenarios (landfill, incineration and Knudsen processes):

- 1) feedstock energy is the starting credit of energy coming from plastics;
- 2) the energy consumption of each process is calculated taking into account the life-cycle of each plant and indicated as irreparably lost energy;
- 3) recovered energy is the energy produced by the process;
- 4) avoided environmental loads is the energy associated with the production of materials or energy recovered by the process.

Table 1 shows the gross energy requirement (GER) calculated for the three processes as well as some other indicators such as global warming potential (GWP), acidification potential (AP) and photochemical ozone creation potential (POCP).



**Figure 5** – Gross energy data associated to 1 kg of treated WEEE for the three scenarios

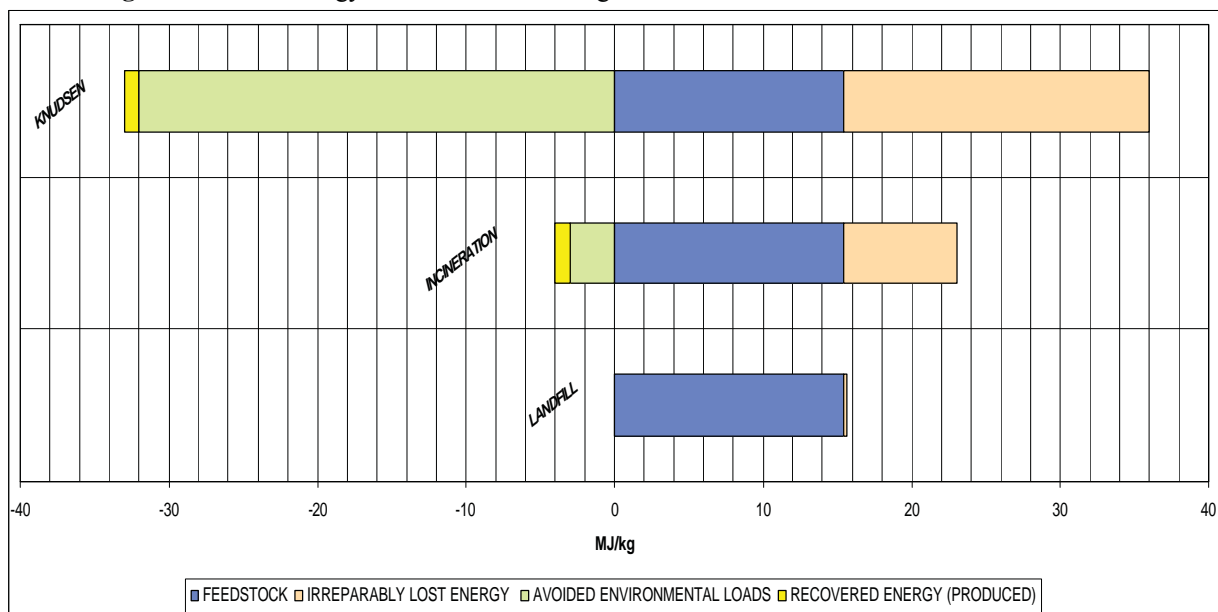

**Table 1.** Some LCA indicators for landfill, incineration and Knudsen process

	GER	GWP <sub>100</sub> [kg CO <sub>2</sub> – eq]	AP [kg SO <sub>2</sub> – eq]	POCP [kg C <sub>2</sub> H <sub>4</sub> – eq]
<b>Landfill</b>	15,68	-	-	-
<b>Incineration</b>	19	1,53	8,9	3,3
<b>Knudsen</b>	4	5,4	60	3

## DISCUSSION

Even if a comparison between the four end-of-life scenarios here considered is not yet available because of the running of pyrolysis process Inventory analysis, some environmental considerations can be done.

Remarketing and reuse of WEEE is a good solution: recently, many enterprises in the EU are investing in this sector, with particular regard to eco-design activities.

Landfill disposal presents a low energy load: the gross energy requirement is almost made up of feedstock that is an irreparably lost energy. From the environmental point of view, it is important to remark that brominated compounds and heavy metals may concentrate in the lechate and that landfill disposal is linked to a natural resource depletion, the availability of territory. Moreover, such scenario does not fit the standards of the EU Directive.

Incineration presents an intermediate energetic load and it allows energy feedstock recovery through electric or thermal energy production, with a waste volume reduction of about 80-90%. From an environmental viewpoint, combustion of WEEE may be dangerous due to bromine, chlorine and heavy metals content. Moreover, incineration entails the definitive lost of recycling materials, in contrast with the aims of the EU Directive.

Knudsen recycling process presents high environmental impacts but a low energy load: although smelt and electrolytic phases are associated to high energy consumptions, this technology permits the recovery of feedstock energy of WEEE, through thermal energy production and of precious and strategic metals. It is estimated that is possible to recover the 95% of the economic value of electronic wastes.

Finally, pyrolysis process is one of the most attractive technique for WEEE recycling, due to the fact that gas fraction should be suitable for HBr production, the oils for chemicals recovery or fuel production and the solid residue for precious and strategic materials recovery. Since LCA activities started with primary data collection on the different technological step of the processes, the information about pyrolysis treatment are not still complete.

## REFERENCES

- AA.VV. - *International Journal of Life Cycle Assessment* - Ecomed Publishers, Germany, all volumes; <http://www.scientificjournals.com/sj/lca/index.php>
- Boustead I., Hancock G. (1979) - *Handbook of Industrial Energy Analysis* - The Open University, West Sussex, England.
- Legarth J., Alting L., Erichsen H., Gregersen J., Jorgensen J. (1994) – *Development of Environmental Guidelines for Electronic Appliances* – The Danish Technical University, Lyngby, Denmark.
- M.P. Luda, N. Euringer, U. Moratti (2003) – *WEEE recycling: pyrolysis of fire retardant model polymers* – Dipartimento di chimica IFM, Università di Torino, Italia.

# Decreased landfilling of waste in Sweden leading to a large expansion of waste incineration – what are the impacts on recycling of polymeric materials?

Mattias Olofsson, PhD candidate  
Energy Systems Technology Division  
Department of Energy Conversion  
Chalmers University of Technology  
S-412 96 Göteborg, Sweden  
Phone: +46 31 772 1442  
E-mail: [mattias.olofsson@me.chalmers.se](mailto:mattias.olofsson@me.chalmers.se)

## Abstract

This brief paper gives an overview of Swedish waste management and recycling of polymeric materials. The introduction of bans on landfilling of sorted combustible waste (2002) and organic waste (2005) will lead to a large expansion of waste incineration, which is outlined in the paper. The impacts on the recycling of polymeric materials are discussed and conclusions are drawn on the competitiveness between thermal recycling through waste incineration, thermal recycling through gasification/pyrolysis for power production and material recycling.

## Swedish waste management

In Sweden, the total annual waste generation is around 90 million tonnes. Industrial waste makes up a large part of the total waste (83 million tonnes). During 1998 (the latest year with statistics for all types of waste) the industrial waste was mainly generated in the mining industry (63,8 million tonnes), the wood manufacturing industry (7,6 million tonnes), the pulp and paper industry (4,0 million tonnes) and the steel and metal industry (3,4 million tonnes) (SCB 2000). Besides industrial waste, other waste types generated in large amounts 1998 were household waste (3,6 million tonnes), construction and demolition waste (2,1 million tonnes) and municipal sewage sludge (1,2 million tonnes) (Profu 2003).

The current treatment varies for different waste types. The mining waste is mainly landfilled, while a large part of the remaining industrial waste is recovered as material or energy by the industries. About 2,5 million tonnes of the industrial waste, excluding waste from the mining industry, was estimated to be landfilled in 1998 (Profu 2003). A small part of the industrial waste is treated outside the industries by municipalities and private waste companies. The municipalities and the private waste companies also treat household waste, construction and demolition waste and municipal sewage sludge.

**Table 1. Treatment of waste by municipalities and private waste companies in 1998 (Profu 2002)**

Treatment	Million tonnes	%
Landfilling	4,4	42
Incineration	2,2	21
Material recycling	1,6	15
Land restoration	1,2	11
Wood waste combusted as biofuel	0,4	4
Biological treatment	0,4	4
Unknown	0,3	3
<b>Total</b>	<b>10,5</b>	<b>100</b>

The total amount of waste treated by municipalities and private waste companies amounted to 10,5 million tonnes in 1998. The treatment of the waste is illustrated in table 1 (see previous page).

Looking at polymeric materials, a lot of attention in Sweden has been directed at packages through ordinances on producers' responsibility. The national target is that 70 % of the plastic packages (excluding plastic bottles in refund systems) are to be recycled. Of this, at least 30 % must be material recycling (thermal recycling is allowed to be used to reach the target of 70 %). Sweden is still far these targets. In 2001, approximately 150 000 tonnes of plastic packaging waste was generated and only 29 % was recycled. Material recycling accounted for almost 14 % and thermal recycling accounted for 15 % (Naturvårdsverket 2002a). However, it must be noted that only separated plastic packaging waste is included in the recycling statistics. Some plastic packaging waste was thermally recycled as a part of the mixed waste being incinerated.

For waste electrical and electronic equipment (WEEE) the situation is quite different. Since the second part of 2001, there is a national ordinance on producers' responsibility for treatment of WEEE. WEEE cannot be landfilled, incinerated or fragmented without pre-treatment, which has resulted in a large separate collection of WEEE. The Swedish Environmental Protection Agency estimates the annual collection of WEEE to be 10 kg/cap,yr (92 000 tonnes) (Naturvårdsverket 2002a). This can be compared to the WEEE-directive (2002/96/EC), where the collection rate must be 4 kg/cap,yr by the end of 2006 (Christiansen 2003). The collected WEEE is pre-treated or recycled by 25 different Swedish recyclers. For fluorescent lamps also a Danish recycler is used. Plastics from TVs and radios are separated at the pre-treatment and sent to waste incineration. Some plastics are also landfilled due to pre-treatment at smelting plants, where the metals in the WEEE are recovered.

A general problem for all players in the Swedish waste management sector is the lack of waste statistics. The latest waste statistics that covers all waste are from 1998. This makes it difficult to follow the development of the waste amounts and also to plan the waste treatment capacity. Currently, only the generation of household waste can be tracked annually. During 1985-2001, the generated amounts of household waste increased by 47 %. This meant that the generation of household waste grew faster than the household consumption and much faster than the population during the same period (Profu 2003).

### **Decreased landfilling**

Sweden has introduced three strong national means of control in order to decrease the landfilling of waste:

- In 2000, a tax on landfilling of waste was introduced. Since January 1, 2003, the tax amounts to 40 euro/tonne.
- On January 1, 2002, a ban on landfilling of sorted combustible waste was introduced.
- On January 1, 2005, a ban on landfilling of organic waste will be in force.

Beside these means of control, there is also a national target that the landfilled waste should be reduced by at least 50 % in 2005 compared to the levels in 1994. This target will be fulfilled if the bans on landfilling of sorted combustible waste and organic waste are fulfilled. However, this is not the current situation. There is not sufficient capacity to treat the sorted

combustible waste that today ends up in landfills. Municipalities and private waste companies can apply for exemptions from the ban if they can show that there is not sufficient alternative waste treatment capacity in their region. The exemptions must be renewed every year. In 2002, the amount of waste that could be landfilled through exemptions from the ban amounted to 1,6 million tonnes (Naturvårdsverket 2002b).

### **Increased waste incineration**

In order to handle the bans on landfilling, municipalities and private waste companies are investigating other options to treat the waste. There are plans for increased material recycling and biological treatment, but the planned treatment capacities are small compared to the plans for waste incineration. Presently there are 24 waste incineration plants in Sweden, which treated 2,5 million tonnes waste in 2001 (RVF 2002). According to the plans for increased waste incineration, the total capacity and the number of plants would be doubled by 2008, resulting in 48 plants with a total capacity of 5,4 million tonnes (Profu 2003).

The waste incineration is currently competitive both from a waste and energy perspective. Waste incineration is a conventional technology, which has been used in Sweden since the beginning of the seventies. It has proved to be able to handle mixed waste fractions where the composition can vary quite substantially. There is no tax on incineration, although this has been investigated several times.

Due to the large expansion of district heating in Sweden<sup>1</sup>, a large part of the energy in the waste can be recovered as district heating. The normal energy efficiency for a Swedish waste incineration plant is around 90 %, and mainly district heating is produced. A few plants have combined heat and power production, but the power-to-heat ratios are low, typically around 0,1. While fossil fuels are highly taxed through energy taxes and CO<sub>2</sub>-taxes, there are no taxes on energy recovered from waste. This makes the energy from waste competitive. Furthermore, the high taxes on alternative fuels mean that the value of district heating produced from waste is increased. Altogether, these factors make the gate fees for waste incineration in Sweden low in a Northern European perspective (c.f. figure 1 next page).

The increased waste incineration will mean that less polymeric waste is landfilled and thus the thermal recycling will increase. The energy in the polymeric waste will mainly be recovered as district heating at a high efficiency. The environmental benefits of the thermal recycling strongly depend on what kind of alternative district heating production is replaced when the waste incineration is increased. If fossil fuels can be replaced, the environmental benefits are large. However, the work by Sahlin (2003) indicates that the increased waste incineration mainly will replace district heating production through biofuels. Thus the environmental benefits will be smaller, based on performed Swedish systems analyses of waste management (Finnveden et al 2000, Ljunggren Söderman 2000 and Sundqvist et al 2002). For plastic packaging waste, all these systems analyses indicates that material recycling means larger environmental benefits compared to waste incineration if the energy recovered at waste incineration replaces other district heating production based on biofuels.

---

<sup>1</sup> In 1999, district heating accounted for 42 % of the space heating market in Sweden. In Germany, the corresponding figure was 12 % (Euroheat & Power 2001).

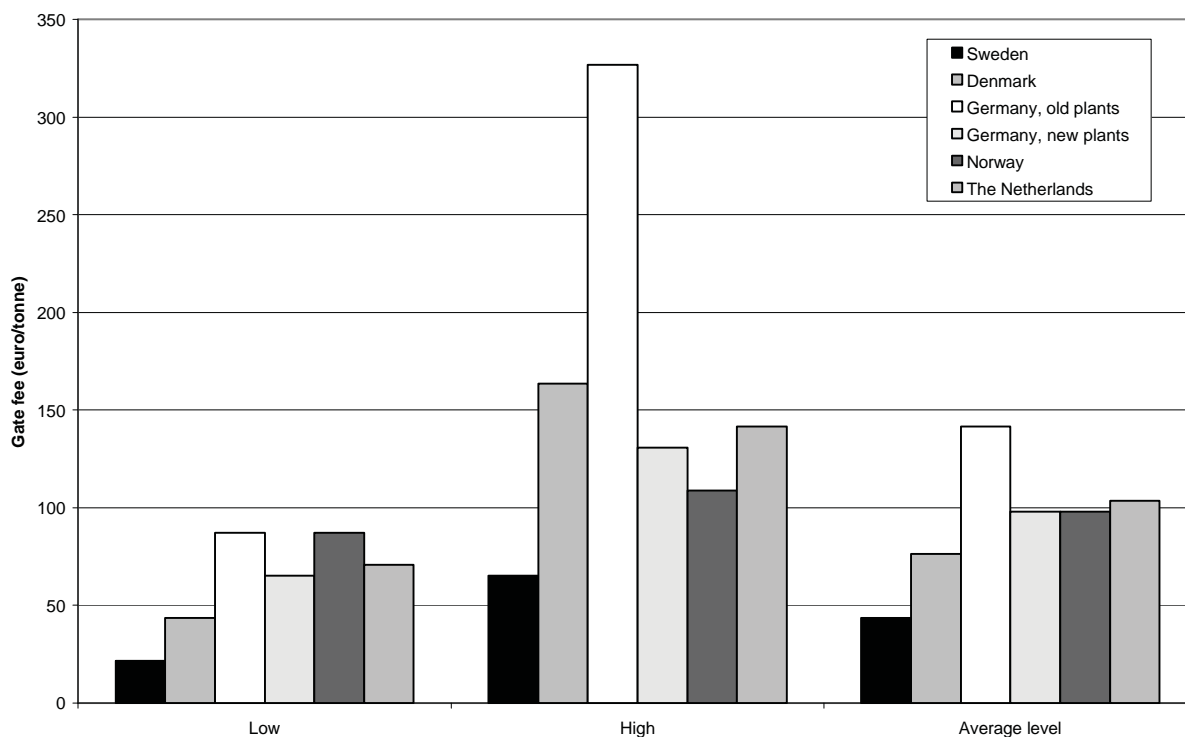

**Figure 1 Typical gate fees for waste incineration in Sweden compared to Denmark, Germany, Norway and The Netherlands<sup>2</sup>**

### **Impacts for gasification/pyrolysis for increased power production**

The large planned expansion of waste incineration will make it more difficult to introduce gasification and pyrolysis as options to thermal recycling. Potentially gasification and pyrolysis could increase the power production from waste in Sweden. However, since the value of district heating is relatively high (through the energy taxes and CO<sub>2</sub>-taxes on fossil fuels) and the electricity price on the common Nordic electricity market<sup>3</sup> still is relatively low, it is hard for gasification and pyrolysis to compete with waste incineration (Olofsson 2001, Olofsson et al 2003), especially considering the gate fees in table 1. The investments that will be made in waste incineration during the next five years will also mean fewer incentives to investigate other options for thermal recycling. To introduce these technologies in Sweden for thermal recycling, international development is necessary which lowers the costs and increases the technical reliability to the same level as waste incineration. The current restructuring of Swedish energy taxes to be harmonised with the rest of EU will be favourable for gasification and pyrolysis compared to waste incineration, but this will not be sufficient to change the current trend.

### **Impacts for material recycling**

During the next five years, all available treatment options must be used to fulfil the bans on landfilling. This means that waste incineration and the existing material recycling of plastic packaging waste will be complementary methods rather than competitors. The current

<sup>2</sup> Data is based on the following references: AEA (2001), AOO (2003), Bögelund et al (2002), Eunomia (2002), Reimann (2002) and personal contacts with Swedish waste incineration plants.

<sup>3</sup> The electricity grids in Sweden, Finland, Denmark and Norway are connected and electricity is traded on a common Nordic market.

material recycling of plastic packaging waste is financed through a fee, which the consumer pays when he/she buys the product. These fees are necessary to make material recycling competitive since the treatment costs are higher due to the separate collection, the necessary central sorting and the low revenues for the recycled material. However, for other kind of plastics, there are no such fees, and material recycling is not a competitive option to waste incineration.

In order to increase the material recycling on a longer term, more national support system will be necessary, e.g. through an extension of the producers' responsibility to other types of plastic waste besides packaging waste. International development of material recycling processes is also necessary. Furthermore, material recycling would benefit from a tax on waste incineration. During autumn 2003, the government will investigate the consequences of a possible tax on waste incineration (Swedish Government 2003).

### **Conclusions**

The bans on landfilling of sorted combustible waste (2002) and organic waste (2005) will lead to a large expansion of waste incineration in Sweden. According to the plans of municipalities and private waste companies, both the number of plants and the capacity would be doubled by 2008, resulting in 48 plants with a total capacity of 5,4 million tonnes. This expansion will lead to an increased thermal recycling of polymeric materials (mainly as district heating) and reduced landfilling. However, with the current beneficial conditions for waste incineration in the waste management system and in the energy system, neither gasification/pyrolysis for power production nor material recycling is competitive with waste incineration. To increase the recycling of polymeric materials through these methods, national support and international development is needed. A tax on waste incineration would also improve the opportunities for these methods.

## References

AEA, *Waste management options and climate change*, Final report to the European Commission, DG Environment, AEA Technology, 2001

AOO, Afvalstoffenheffing,

[http://www.aoo.nl/default.htm?http%3A//www.aoo.nl/page.asp%3Fmenu\\_id%3D70](http://www.aoo.nl/default.htm?http%3A//www.aoo.nl/page.asp%3Fmenu_id%3D70), 2003-05-06

Bögelund, M., Willumsen, E. og Jensen, M.P., Effektiviseringspotentiale på forbrændingsanlæg og deponeringsanlæg i Danmark, Orientering fra Miljøstyrelsen Nr. 2, 2002

Christiansen, J., *Eldirektivet i klartext, del 1*, RVF-Nytt Nr 2, RVF, Malmö, 2003

Eunomia, *Costs for Municipal Waste Management in the EU*, Final Report to Directorate General Environment, Eunomia Research & Consulting Ltd., 2002

Euroheat & Power, *District Heat in Europe. Country by Country – 2001 Survey*, Euroheat & Power, unichal, Bruxelles, 2001

Finnveden, G., Johansson, J., Lind, P. and Moberg, Å, *Life Cycle Assessments of Energy from Solid Waste*, fms 137, Forskningsgruppen för miljöstrategiska studier, Stockholm, 2000

Ljunggren Söderman, M., *A Systems Engineering Approach to National Waste Management*, Thesis for the degree of Doctor of Philosophy, Department of Energy Conversion, Chalmers University of Technology, Göteborg, Sweden, 2000

Naturvårdsverket (Swedish Environmental Protection Agency), *Samla in återvinn! Uppföljning av producentansvaret för 2001, men också mycket mer.....*, Rapport 5237, Naturvårdsverket, Stockholm, 2002a

Naturvårdsverket, *Uppföljning av deponeringsförbuden*, redovisning av regeringsuppdrag, Naturvårdsverket, Stockholm, 2002b

Olofsson, M., *Linking the Analysis of Waste Management Systems and Energy Systems*, Licentiate Thesis, Department of Energy Conversion, Chalmers University of Technology, Göteborg, Sweden, 2001

Olofsson, M., Sahlin, J. and Unger, T., *Will New Waste-to-energy Technologies Enter the Swedish Waste Management Market?*, paper to be presented at the A&WMA 96th Annual Conference and Exhibition, San Diego, California, USA, June 22-26, 2003

Profu, *Kapacitet för att ta hand om brännbart och organiskt avfall*, RVF-rapport 02:02, RVF, Malmö, 2002

Profu, *Kapacitet för att behandla brännbart och övrigt organiskt avfall*, underlagsrapport åt Naturvårdsverket, Profu, Mölndal, 2003

Reimann, D. O., *Mögliche Veränderungen der Abfallstoffströme und MVA Auslastungen nach Inkrafttreten der Gewerbeabfallverordnung*, Müll und Abfall 9, 496-501, 2002



RVF (The Swedish Association of Waste Management), *Svensk Avfallshantering 2002*, RVF, Malmö, 2002

Sahlin, J., *Waste Incineration – Future Role in the Swedish District Heating Systems*, Licentiate Thesis, Department of Energy Conversion, Chalmers University of Technology, Göteborg, Sweden, 2003

SCB (Statistics Sweden), *Avfall från tillverkningsindustrin och utvinning av mineraler 1998*, MI 28, SM 0001, SCB, Stockholm, 2000

Sundqvist, J., Baky, A., Carlsson Reich, M., Eriksson, O. and Granath, J., *Hur skall hushållsavfallet tas om hand? Utvärdering av olika behandlingsmetoder*, IVL rapport 1462B, IVL, Stockholm, 2002

Swedish Government, *Ett samhälle med giftfria och resurssnåla kretslopp*, Government bill 2002/03:117, delivered to the Parliament on May, 15, 2003

# Ecoefficient Recovery Options for Plastics from Cars

Klaus Wittstock, BASF AG Ludwigshafen  
Axel Kistenmacher, APME Brussels

## 1. Background

Throughout Western Europe the recovery of End-of-Life-Vehicles (ELVs) is subject to new legislation. The European ELV Directive 2000/53/EC defines recovery, reuse and recycling targets by weight for vehicles. The traditional recovery routes for ELVs are metal oriented. The majority of the other materials are landfilled since currently this still represents the most economic solution.

Achievement of the ELV Directive targets will demand that non-metal fractions are also recovered/recycled. Different recovery routes will therefore be needed. From a technological viewpoint, for the plastics fraction there exist four main options involving six feasible technologies:

- Mechanical recycling: The dismantling of plastic parts and subsequent mechanical recycling represent one possible scenario. The recyclate would then substitute virgin material (closed or open loop).
- Feedstock recycling: Post-treated shredder residue can be processed in feedstock recycling processes such as blast furnaces or syngas production.
- Energy Recovery: After shredding the ELV and separating the metals, the shredder residue contains the plastics fraction amongst other materials. The shredder residue can either be used as a fuel substitute in cement kilns after treatment, or directly in municipal waste combustion in order to recover the energy content.
- Landfill: This option was evaluated for comparison reasons only. From the viewpoint of resource efficiency, landfill does not represent a viable option and will be banned for shredder residue.

## 2. Objectives of the study

Which are the best recovery options for plastic parts from end-of-life vehicles in terms of both environmental and economic considerations? Does it make a difference, whether the individual part is large and easily accessible? And what if the vehicles whole life-cycle is taken into consideration?

These questions are answered with a transparent evaluation tool by the study recently undertaken by Öko-Institut e.V., Darmstadt. In this study, the “Eco-Efficiency-Analysis”-method was used, which was originally developed as a strategic decision tool by industry and combines a life-cycle-assessment according to ISO 14040 with an economic analysis.

Eleven environmental impact factors were assessed. After aggregation, these environmental data were combined with the corresponding cost data in an eco-efficiency analysis. Displaying the results in an eco-efficiency portfolio provides a comprehensive mapping of the results.

The eco-efficiency analysis is a tool which is able to structure the link between environment and cost and is able to analyse questions concerning the efficiency of the various recovery measures. As this study was peer reviewed by independent experts

the results should facilitate fact-based discussions with the various stakeholders. The study is a first step, based on existing data, completed by expert judgement, involving the inherent limitations of a first approach.

### 3. Analysed parts and use of recyclates

In vehicles, different types of plastic are used in the production of different components. The driving factors for the use of plastics in transportation are light weight (low density of plastics) as well as specific combinations of properties and economic processability. In modern cars, the total share of plastics is estimated in the range of 10-15% by weight with a clear tendency to grow.

In order to evaluate the differences between the recovery options, this study investigated the recovery of seven plastic parts made from different plastic types and representing different sizes and weight (0.27 kg – 3.14 kg, see table 1.1 below), in terms of eco-efficiency.

A key to the generation of high performing recyclates from the various plastic materials used in a car is explicit identification and type specific separation. Without this pre-treatment, the recyclate can only be used for low quality applications with very limited markets. Recyclates generally do not achieve the technical performance of virgin material. To extend their use they are normally blended with virgin material. Pre-treatment for mechanical recycling generally requires the dismantling of the plastic parts. In contrast to other recovery options, both dismantling and treatment are cost-intensive process steps.

Part	Weight (kg/part)	Material	Filler
Bumper	3.14	PP	No
Seat cushions	1.20	PUR	No
Intake manifold	0.72	PA	30% glass fibre
Wash-liquid tank and lid	0.43	PE	No
Air duct	0.95	PP	20% talcum
Headlamp lens	0.30	PC	No
Mirror housing	0.27	ABS	No

**Table 1.1** Analysed plastic parts

### 4. Sensitivity analysis

Eco-efficiency is based on model scenarios and should be interpreted accordingly. In order to get an impression on the consequences of changing parameters, a sensitivity analysis was performed in three different areas:

- Toxicology

As risk potential and toxic potential are not included in a standard LCA, two borderline cases were analysed to evaluate their possible impacts on the eco-efficiency portfolio (A: Toxic and risk potentials for all options equivalent; B: No toxic and risk potentials included).

- Substitution factor (S)

The environmental benefit of mechanical recycling is strictly related to the substitution factor. The substitution factor is the quantity of virgin material (in kg)

that can be substituted by 1 kg of recyclate in the end product in order to achieve equivalent performance. For example, if a 500 g plastic part made from virgin material could only be substituted by 1 kg of recyclate, then  $S = 0.5$ .

The study base case assumes an ideal waste stream with  $S=1$ . This means that in the case of mechanical recycling, recyclate substitutes virgin plastic material completely (1/1 substitution). This represents a “best-case” scenario. Knowledge about the potential applications is limited and therefore the results obtained for mechanical recycling cannot be transferred to the total amount of potentially recyclable plastic. The potential market share of recycled plastics was outside the scope and goal of this study and has therefore not been estimated.

Practical experience shows that, due to application requirements, under real market conditions a substitution factor of 1 can hardly ever be achieved in automotive recycling. Therefore substitution factors lower than 1 were analysed in this study.

- **Future technologies**

Limited experience shows that plastics from ELVs can be treated in the described technologies. For some routes pilot trials have been performed but these are often too small to provide reliable information on technology performance and real costs, including the investment required for a full industrial-scale plant. In addition to standard processes, one pilot-scale recovery option (Galloo process) was analysed and assessed. In order to generate the appropriate input data for the eco-efficiency analysis, the individual process steps were investigated and theoretically assembled into a corresponding process chain.

## **5. General conclusions**

- Mechanical recycling is the method of choice only for large, easily accessible, monomaterial parts under the assumption that there is no significant material deterioration and a sufficient market for the material exists.
- For most of the parts studied, feedstock recycling options and energy recovery options are the methods of choice, combining favourable environmental and economic features.
- Landfill shows the worst eco-efficiency performance in comparison with the other recovery options
- The investigation of the whole life-cycle reveals that it is the use-phase of plastic parts in cars that has by far the largest contribution to the environmental impacts. Hence it is important to optimize the plastic parts for the use-phase (e.g. lightweight, durability) rather than just focus on the end-of-life phase.