

Dynamic and Intermodal Disruption-Management for Commuter Railway Networks

Dynamisches und intermodales Störfallmanagement für S-Bahn Systeme

Graduiertenkolleg KRITIS

M.Sc. Arturo Crespo Materna aus La Paz - Bolivien

Zur Erlangung des akademischen Grades Doktor-Ingenieur (Dr.-Ing.)

Tag der Einreichung: 16.10.2019

Tag der Prüfung: 14.02.2020

1. Gutachten: Prof. Dr.-Ing. Andreas Oetting
2. Gutachten: Prof. Dr.-Ing. Ullrich Martin



TECHNISCHE
UNIVERSITÄT
DARMSTADT



Institut für
Bahnsysteme und
Bahntechnik

DFG Deutsche
Forschungsgemeinschaft

GRADUIERTENKOLLEG

KRITIS 



Darmstadt, Technische Universität Darmstadt,
Jahr der Veröffentlichung der Dissertation auf TUprints: 2020

Schriftenreihe der Institute für Verkehr
Institut für Bahnsysteme und Bahntechnik

Heft B12
ISSN 1614-9300

Bitte zitieren Sie dieses Dokument als:
URN: urn:nbn:de:tuda-tuprints-116626
URI: <https://tuprints.ulb.tu-darmstadt.de/id/eprint/11662>
Tag mündlichen Prüfung: 14. Februar 2020

Veröffentlicht unter CC BY-SA 4.0 International
<https://creativecommons.org/licenses>





TECHNISCHE
UNIVERSITÄT
DARMSTADT

Dynamic and Intermodal Disruption-Management for Commuter Railway Networks
Dynamisches und intermodales Störfallmanagement für S-Bahn Systeme

Vom Fachbereich
Bau- und Umweltingenieurwissenschaften
der Technischen Universität Darmstadt
zur Erlangung des Grades eines
Doktor-Ingenieurs (Dr.-Ing.)
genehmigte

Dissertationsschrift

von

M.Sc. Arturo Crespo Materna
Geboren am 8. Dezember 1989 in La Paz - Bolivien

Referent: Prof. Dr.-Ing. Andreas Oetting
Korreferent: Prof. Dr.-Ing. Ullrich Martin

Tag der Einreichung: 16. Oktober 2019
Tag der Disputation: 14. Februar 2020

Darmstadt, 2020
Hochschulkennziffer D17



Para mi abuelo
Arturo Crespo Enríquez

1930-2017

Tu vida y obra ha sido una inspiración para todos nosotros
Your life and deed has been an inspiration for all of us



Abstract

Railway systems are particularly vulnerable to the occurrence of unexpected events and disruptions due to their size and the complex arrangement of their different components and operations (i.e. stations, tracks, switches, vehicles, personnel, passenger traffic, signals, operation control, schedules, etc.). As disruptions for any critical infrastructure are inevitable, decision-makers need to establish strategies aimed at guaranteeing the operational continuity of the systems and upholding basic service qualities during these events. In many railway networks, planned disruption-management approaches have been established for a structured reaction to the disruption. Planned disruption-management approaches foresee the development and implementation of disruption programs (DRPs).

DRPs can be explained as sets of pre-defined dispatching measures for trains, rerouting measures for disrupted passengers and communication protocols for staff members, which are developed to address specific disruption scenarios within a railway network. In consequence, every DRP contains a set of line-specific measures (i.e. valid for a whole line), which is mainly constituted by two different concepts, namely, an operating concept and a transport concept. The operating concept contains a series of line-specific measures that allow the operating program of a line to adjust to the degraded infrastructure availability induced by the disruption. The transport concept contains a series of passenger rerouting measures that address the affected serviceability of the system.

DRPs are implemented across different phases. Among these phases, the transition phase to stable operations is arguably the most critical. The transition phase lasts from the declaration of the chosen DRP and until the system has reached stable operations during the disruption. Stability is only achieved when all trains run reliably on their DRP envisioned (shortened) routes with (reduced) frequencies, without accumulating delay. To date, dispatchers execute the implementation of DRPs manually. Therefore, the successful deployment of a DRP on a disrupted network is still critically influenced by the experience and skill of highly strained dispatchers.

DRP development itself is also a strenuous process, which requires the involvement of different stakeholders (e.g. experienced dispatchers, public transport operators and others). While some work has been aimed at transitioning from a manual development of DRPs to a development assisted by a decision-support system, there are still gaps to be filled. The evaluation of intermodal passenger rerouting measures within transport concepts requires particular attention.

The work presented throughout this document has two specific objectives. The first objective is to develop a model that allows decision-makers to develop passenger intermodal rerouting strategies for DRP transport concepts, which consider the residual capacity of local public transport systems. The second objective is the development of a system capable of supporting the dynamic deployment of DRP operating concepts on an actual operating situation of the network. Each of the objectives focuses on the different concepts within DRPs, yet they are unrelated to one another. Therefore, this work is divided into two different *Sections*.

The first *Section* describes the development of a model for estimating the residual capacity of the public transport means utilized for the intermodal rerouting of passengers, as foreseen in the DRP transport concept under investigation. The assessed passenger rerouting strategies provide a foundation for a subsequent and much more in-depth discussions with local public transport operators. To support an estimation of the residual capacity, an assessment framework is derived and validated utilizing actual operational information from three public transport modes namely,

buses, light rail and subway. The model incorporates the assessment framework and is structured using rule-based algorithms supported by graph theory. The model has the capability to incorporate different rerouting strategies from DRP transport concepts. Furthermore, the model is designed for general validity and be applicable regardless of the implementation environment (i.e. means of public transport and layout of the public transport and disrupted railway networks).

The second *Section* constitutes the main contribution of this work. It introduces a system for the dynamic deployment of the line-specific DRP operating concept to the actual operating situation of a disrupted commuter railway network. The actual disrupted situation considers the time of day, the actual position of the trains in the network, and the affected infrastructural elements. As a result, the system delivers a train number and minute-specific (i.e. with an accuracy of seconds) conflict-free schedule that ensures the network is able to reach stable operations. The dynamic DRP deployment system is conceived in a modular structure so that its modules can be easily updated or replaced and eventually, new modules can be added. Each one of the modules that constitute the system is derived and discussed in detail throughout this work.

In line with the problem, the dynamic DRP deployment system foresees the adjustment of both the schedule and circulation plans of the disrupted commuter railway network. The system is structured through heuristic (i.e. heuristic conflict identification - or CD - and conflict resolution - or CR - approaches) and metaheuristic methods (i.e. Genetic and Tabu Search algorithms) to address the mostly NP-hard problems. Additionally, the system divides the overall problem into two different operational levels: line-specific and vehicle-specific.

At the line-specific level, the approach identifies and classifies line-specific conflicts (including vehicle availability and reachability conflicts) and establishes potential conflict solution alternatives with support of the DRP operating concept as well as a predefined set of eight types elemental conflict solutions. The potential solution alternatives are implemented on individual trains in order to solve the line-specific conflicts and establish a set of conflict resolution alternatives at the line-specific operational level.

The alternatives that have been generated at the line-specific operational level are combined through metaheuristic algorithms. Each combination is later handled at the vehicle-specific operational level. A heuristic vehicle-specific CDCR approach identifies and resolves any induced conflict to obtain a conflict-free schedule from every combination. At this level, the CDCR process handles four different types of conflicts. These include occupancy, infrastructure availability, circulation and service conflicts. For every identified conflict, the CDCR process develops potential conflict resolution alternatives utilizing six types of elemental conflict solution alternatives. The conflict resolution alternatives are evaluated by contemplating aspects such as the expected relative-time change, the induced change on the projected operating situation, changes on the platform tracks and train service or train stop cancellations. Once assessed, only one conflict resolution alternative is selected and implemented.

Furthermore, once the combinations are conflict-free, they are evaluated according to already assessed information from every conflict resolution utilized to derive the conflict-free combination. This is complemented by an evaluation of the induced end-of-day imbalances (i.e. vehicles that terminate their duties at locations in the network that are not compatible with the scheduled operations on the next day) and changes in the turning stations of the trains. Finally, having ascertained the fitness of every conflict-free combination, the system is able to select and display the best alternative.

Ultimately, the contribution advanced in the second *Section* of this work lays the foundation for a semi-automated deployment of the DRP operating concepts in the actual operating situation of the network. The dynamic DRP deployment system is strictly designed to uphold the prompt transition of the network toward stable operations. While the system is designed for commuter railway networks, it can be employed regardless of their local implementation environment.

Kurzfassung

Eisenbahnsysteme sind aufgrund ihrer Komplexität (Personal, Personenverkehr, Signale, Betriebssteuerung, Fahrpläne usw.), ihrer z.T. hohen Auslastung und begrenzter Redundanzen besonders anfällig für das Auftreten unerwarteter Ereignisse und Störungen. Da Störungen für kritische Infrastrukturen unvermeidlich sind, müssen Entscheidungsträger Strategien festlegen, die darauf abzielen, die Betriebskontinuität der Systeme zu gewährleisten und die grundlegenden Servicequalitäten während dieser Vorkommnisse so weit wie möglich aufrechtzuerhalten. Für verschiedene Arten von Eisenbahnnetzen wurden im Rahmen des präventiven Störfallmanagements Verfahren für eine strukturierte Reaktion auf Störungen festgelegt. Diese sehen die Entwicklung und Implementierung von Störfallprogrammen (SFP) vor.

SFP beinhalten vordefinierte Dispositionsmaßnahmen für Züge, Lenkungsmaßnahmen für Fahrgäste und Kommunikationsprotokolle für Mitarbeiter und wurden entwickelt, um bestimmte Störungsszenarien innerhalb eines Eisenbahnsystems mit geringem Aufwand zügig zu managen. Dazu enthält jedes SFP eine Reihe von linienspezifischen Maßnahmen (gültig für eine ganze Linie), die hauptsächlich aus zwei unterschiedlichen Konzepten bestehen: einem Betriebskonzept und einem Verkehrskonzept. Das Betriebskonzept enthält eine Reihe von Maßnahmen, mit denen das Betriebsprogramm einer Linie an die durch die Störung verursachte eingeschränkte Verfügbarkeit der Infrastruktur angepasst wird. Das Verkehrskonzept enthält eine Reihe von Maßnahmen zur Lenkung der Passagiere und damit zur Aufrechterhaltung der Mobilität innerhalb des Systems.

SFP werden in verschiedenen Phasen umgesetzt. Unter diesen Phasen ist die Einschwingphase und damit der Übergang in einen stabilen Betrieb die kritischste Phase. Die Einschwingphase dauert von dem Ausrufen des gewählten SFPs bis zum Beginn des stabilen Betriebs des Systems während der Störung. Ein stabiler Betrieb ist überdurchschnittlich nur erreicht, wenn alle Züge zuverlässig auf ihren im SFP geplanten (verkürzten) Strecken mit (reduzierten) Takten fahren, ohne dass es zu Verspätungen kommt. Bisher führen Disponenten die Umsetzung von SFP manuell aus. Daher wird die erfolgreiche Umsetzung eines SFP in einem gestörten Netz immer noch entscheidend von der Erfahrung und den Fähigkeiten der in dieser Situation stark belasteten Disponenten beeinflusst.

Die SFP-Entwicklung selbst ist ebenfalls ein komplexer Prozess, bei dem verschiedene Interessengruppen (z. B. erfahrene Disponenten, Betreiber öffentlicher Verkehrsmittel, ...) einbezogen werden müssen. Während einige Ansätze darauf abzielten, von einer manuellen Entwicklung von SFPs zu einer Entwicklung mit Hilfe eines Entscheidungsunterstützungssystems überzugehen, sind noch Lücken in dieser Entwicklung zu schließen. Besonderes Augenmerk muss auf die Bewertung von Maßnahmen zur intermodalen Reisendenlenkung im Rahmen der Verkehrskonzepte gelegt werden.

Die in dieser Arbeit vorgestellten Modelle verfolgen zwei spezifische Ziele. Das erste Ziel besteht darin, ein Modell zu entwickeln, mit dem Entscheidungsträgern Maßnahmen für die intermodale Lenkung von Fahrgästen für SFP-Verkehrskonzepte entwickeln können, die die Restkapazität lokaler öffentlicher Verkehrssysteme berücksichtigen. Das zweite Ziel ist die Entwicklung eines Modells, das die dynamische Bereitstellung von zugspezifischen SFP-Betriebskonzepten in einer tatsächlichen Betriebsituation des Netzes teilautomatisieren kann. Jedes der Ziele konzentriert sich auf die verschiedenen Konzepte (Betriebs- und Verkehrskonzepte) innerhalb der SFP, sie sind jedoch nicht miteinander verbunden. Daher ist diese Arbeit in zwei verschiedene Hauptteile (*Sections*) unterteilt.

Im *ersten Hauptteil* wird ein Modell zur Abschätzung der Restkapazität der öffentlichen Verkehrsmittel, die sich für die intermodale Lenkung von Fahrgästen eignen könnten, entwickelt. Das Modell ermöglicht die Prüfung von Entwürfen intermodaler SFP-Verkehrskonzepte anhand ihrer Auswirkungen auf die Auslastung von Bus, Stadtbahn und U-Bahn als Grundlage für die anschließende Diskussion mit den Betreibern der alternativen Verkehrsmittel und dem Aufgabenträger.

In einem ersten Schritt werden die für die Umleitung der Reisenden verfügbaren Restkapazitäten für Reisende abgeschätzt. Als wesentliche Einflussgrößen wurden die Gefäßgrößen, der Fahrplan sowie die abgeschätzte Auslastung, die von Tageszeit, Entfernung vom Stadtzentrum und Verkehrsmittel abhängt, anhand von Daten mehrerer deutscher Städte unterschiedlicher Größe identifiziert. Die Auslastung konnte datengetrieben in Abhängigkeit der genannten Einflussgrößen ohne Einschränkung der Allgemeingültigkeit geschätzt werden.

In einem zweiten Schritt wurde ein Algorithmus zum kapazitätsabhängigen Routing entwickelt und auf einen Störfall beispielhaft angewendet. Mit diesem Algorithmus lassen sich kalibrierungsfrei Entwürfe für Umleitungskonzepte für die Reisenden automatisiert unter Berücksichtigung der verfügbaren Restkapazitäten als Grundlage für die anschließende Abstimmung mit den Betreibern der alternativen Verkehrsmittel und dem Aufgabenträger bewerten.

Der *zweite Hauptteil* bildet den Kern dieser Arbeit. Gegenstand ist die Entwicklung eines Systems zur störungs- und fahrzeugspezifischen Konkretisierung des linienspezifischen SFP-Betriebskonzepts unter Beachtung der tatsächlichen Betriebssituation eines gestörten S-Bahnnetzes. Das Modell berücksichtigt die Tageszeit, die tatsächliche Position der Züge im Netz und die von der Störung betroffenen Infrastrukturelemente. Ergebnis des somit dynamischen Systems ist ein zugnummern- und minutenscharfer (sekundengenauer) konfliktfreier Fahrplan, der einen Übergang von der aktuellen Betriebssituation in einen stabilen Betrieb sicherstellt. Dazu werden Lösungen für die (integrierte) Lösung sowohl von Verfügbarkeits- und Belegungskonflikten als auch von Anschluss- und Umlaufkonflikte unter besonderer Berücksichtigung der typischerweise auftretenden Staueffekte vor dem SFP-Wendebahnhof entwickelt.

Das dynamische SFP-Umsetzungssystem ist modular aufgebaut, sodass seine Module leicht aktualisiert oder ersetzt und neue Module hinzugefügt werden können. Jedes der Module des Systems wird in dieser Arbeit algorithmisch untersetzt. Soweit sich keine existierenden Ansätze eignen, werden die erforderlichen Algorithmen neu entwickelt, wobei die Art der verwendeten Algorithmen problemabhängig gewählt wird.

Problemkonform sieht das dynamische System die Anpassung sowohl des Fahrplans als auch der Umlaufpläne des betroffenen S-Bahnnetzes vor. Das System umfasst für die meist NP-harten Probleme sowohl heuristische Konflikterkennungs- und Konfliktlösungsansätze und metaheuristische Methoden (genetische und Tabu-Such Algorithmen).

Im Falle heuristischer Ansätze werden je Konflikt grundsätzlich mehrere Konfliktlösungsalternativen generiert. Die Grundlage bilden jeweils ca. sechs bis acht problemabhängig entwickelte elementare Konfliktlösungen. Zur Auswahl der geeignetsten Konfliktlösung werden die potentiellen Alternativen vergleichend unter Berücksichtigung weiterer Konflikte bewertet. Die Bewertung umfasst Kenngrößen wie die erwartete relative zeitliche Änderung, die induzierte Änderung der weiteren Betriebssituation, Gleiswechsel und Haltausfälle.

Die Konfliktlösung erfolgt differenziert nach linienspezifischen und darauf aufbauend fahrzeugspezifischen Konflikten.

Die linienspezifischen Konflikte, die Fahrzeugverfügbarkeits- und Erreichbarkeitskonflikte umfassen, werden zunächst identifiziert und klassifiziert. Die auf linienspezifischer Betriebsebene generierten Alternativen werden durch metaheuristische Algorithmen kombiniert.

Jede Kombination wird darauf aufbauend auf die fahrzeugspezifische Betriebsebene übertragen. Ein heuristischer fahrzeugspezifischer KE/KL Algorithmus identifiziert (KE) und löst (KL) jeden induzierten Konflikt, um für jede Kombination einen konfliktfreien Fahrplan zu erhalten. Auf dieser Ebene behandelt der KE/KL Algorithmus vier verschiedene Arten von Konflikten.

Anschließend werden die einzelnen Konfliktlösungsalternativen zu konfliktfreien Kombinationen zusammengestellt und anhand der Informationen aus jeder einzelnen Konfliktlösung bewertet. Dies wird ergänzt durch eine Bewertung der Fahrzeugpositionen am Tagesende (Fahrzeuge, die ihren Dienst an einem Ort im Netz beenden, der nicht mit dem geplanten Ort für die Abstellung, Wartung oder Instandhaltung entspricht) und Änderungen an den geplanten Wendebahnhöfen der Züge. Nachdem das System die technische und betriebliche Eignung jeder konfliktfreien Kombination festgestellt hat, kann es die beste Alternative auswählen.

Zusammenfassend bildet das im zweiten Hauptteil dieser Arbeit erarbeitete System die Grundlage für die halbautomatische störungs- und fahrzeugspezifische Konkretisierung von SFP-Betriebskonzepten unter Beachtung der tatsächlichen Betriebssituation des gestörten Netzes. Das für S-Bahnen erarbeitete dynamische System ist darauf ausgelegt, unmittelbar eine Lösung für den Übergang des Betriebs in einen stabilen Zustand zu entwickeln.

Resumen

Los sistemas ferroviarios son particularmente vulnerables a la ocurrencia de eventos inesperados y interrupciones debido a su dimensión y compleja disposición de sus componentes y operaciones (es decir: estaciones, vías, interruptores, vehículos, personal, tráfico de pasajeros, señales, control de operaciones, horarios, etc.). Como la ocurrencia de interrupciones en cualquier infraestructura crítica es inevitable, los responsables de la toma de decisiones deben establecer estrategias destinadas a garantizar la continuidad operativa de los sistemas y mantener las cualidades del servicio básico durante estos eventos. En muchas redes ferroviarias, se han establecido enfoques planificados de gestión de interrupciones para una reacción estructurada a las interrupciones. Los enfoques planificados de gestión de interrupciones prevén el desarrollo y la implementación de programas de interrupción (DRP - por sus siglas en inglés).

Los DRP pueden explicarse como conjuntos de medidas de despacho predefinidos para trenes, medidas de re direccionamiento para pasajeros y protocolos de comunicación, para miembros del personal, que se desarrollan en el abordaje de escenarios de interrupción específicos dentro de una red ferroviaria. En consecuencia, cada DRP contiene un conjunto de medidas específicas de línea (es decir, válido para una línea completa), que están constituidas principalmente por dos conceptos diferentes: un concepto operativo y un concepto de transporte. El concepto operativo contiene una serie de medidas específicas de línea que permiten que el programa operativo de una línea se ajuste a la disponibilidad de infraestructura degradada inducida por la interrupción. El concepto de transporte contiene una serie de medidas de re direccionamiento de pasajeros que lidian con la capacidad de servicio afectada del sistema.

Los DRP se implementan en diferentes fases. Entre estas fases, la fase de transición a operaciones estables es posiblemente la más crítica. La fase de transición dura desde la declaración del DRP hasta que el sistema ha alcanzado operaciones estables durante la interrupción. La estabilidad solo se logra cuando todos los trenes se mueven por el sistema de manera confiable en sus rutas visualizadas en el DRP (acortadas) con frecuencias reducidas, sin acumular más demora. Hasta la fecha, los despachadores ejecutan la implementación de DRP manualmente. Por lo tanto, el despliegue exitoso de un DRP en una red afectada por efectos disruptivos, aún está críticamente influenciado por la experiencia y habilidad de los despachadores.

El desarrollo de los DRP en sí mismos también es un proceso extenuante, que requiere la participación de diferentes actores (por ejemplo, despachadores, operadores de transporte público y otros). Si bien parte del trabajo ha tenido como objetivo la transición de un desarrollo manual de DRP a un desarrollo asistido por un sistema de apoyo durante la toma de decisiones, todavía quedan vacíos por cubrir. La evaluación de las medidas de desvío de pasajeros intermodales dentro de los conceptos de transporte requiere una atención particular.

El trabajo presentado en este documento, tiene dos objetivos específicos. El desarrollo de un modelo que permita a los tomadores de decisiones desplegar estrategias de re direccionamiento intermodal de pasajeros para los conceptos de transporte DRP, que consideren la capacidad residual de los sistemas locales de transporte público y el desarrollo de un sistema capaz de soportar el despliegue dinámico de conceptos operativos DRP en una situación operativa real. Cada uno de los objetivos se centra en los diferentes conceptos al interior de los DRP; por tanto, no están relacionados entre sí. En este sentido, el presente trabajo se divide en dos secciones diferentes:

La primera sección describe el desarrollo de un modelo para estimar la capacidad residual de los medios de transporte público utilizados para el re direccionamiento intermodal de pasajeros durante una disrupción, como se prevé en el concepto de transporte DRP bajo investigación. Las estrategias de re direccionamiento de pasajeros evaluadas proporcionan una base para discusiones posteriores y mucho más detalladas con los operadores locales de transporte público. Para respaldar una estimación de la capacidad residual, se deriva y valida un marco de evaluación utilizando información operativa real de tres modos de transporte público: autobuses, tren ligero y metro. El modelo incorpora el marco de evaluación y está estructurado utilizando algoritmos basados en reglas respaldadas por teoría gráfica. El modelo tiene la capacidad de incorporar diferentes estrategias de re direccionamiento de los conceptos de transporte DRP y está diseñado para asegurar una validez general que pueda aplicarse independientemente del entorno de implementación (es decir, medios de transporte público y diseño del transporte público y redes ferroviarias interrumpidas).

La segunda sección constituye la principal contribución de este trabajo. Introduce un sistema para el despliegue dinámico del concepto operativo DRP a la situación operativa real de una red ferroviaria afectada por una disrupción. La situación operativa real considera la hora del día, la posición actual de los trenes en la red y los elementos de infraestructura afectados. Como resultado, el sistema entrega un horario sin conflictos, especificando el número de tren con una precisión de segundos y garantizando que la red pueda alcanzar operaciones estables. El sistema de despliegue dinámico de DRP está concebido como una estructura modular para que sus módulos puedan actualizarse o reemplazarse fácilmente y, eventualmente, se puedan agregar nuevos módulos. Cada uno de los módulos, que constituyen el sistema, se derivan, analizan y describen en detalle a lo largo de este trabajo.

Para cumplir su objetivo, el sistema de despliegue dinámico de DRP prevé el ajuste, tanto del horario como de los planes de circulación, de la red ferroviaria en disrupción. El sistema está estructurado a través de métodos heurísticos (es decir, identificación heurística de conflictos - o IC - y resolución de conflictos - o RC -) y métodos metaheurísticos (es decir, algoritmos de búsqueda tabú y genéticos) para hacer frente a los problemas mayormente NP-Hard, y divide el problema en dos niveles operativos diferentes: nivel específico de línea y nivel específico del vehículo.

En el nivel específico de línea, el enfoque identifica y clasifica conflictos específicos de línea (incluidos los conflictos de disponibilidad de vehículos y conflictos de alcance) y establece posibles alternativas de solución de conflictos con el apoyo del concepto operativo DRP, así como un conjunto predefinido de ocho tipos de soluciones elementales. Las posibles alternativas de solución se implementan en trenes individuales para resolver los conflictos específicos de la línea y establecer un conjunto de alternativas de resolución de conflictos a nivel operativo específico de la línea.

Las alternativas que se han generado en el nivel operativo específico de la línea se combinan mediante algoritmos metaheurísticos. Cada combinación se maneja más tarde en el nivel operativo específico del vehículo. Un enfoque de ICRC heurístico específico a nivel vehicular identifica y resuelve cualquier conflicto inducido para obtener un horario libre de conflictos de cada combinación. En este nivel, el proceso ICRC maneja cuatro tipos diferentes de conflictos. Estos incluyen ocupación, disponibilidad de infraestructura, circulación y conflictos de servicio. Para cada conflicto identificado, el proceso ICRC desarrolla posibles alternativas de resolución de conflictos utilizando seis tipos de alternativas de solución de conflictos elementales. Las alternativas de resolución de conflictos se evalúan contemplando aspectos como el cambio de

tiempo relativo esperado, el cambio inducido en la situación operativa proyectada, los cambios en las vías o las cancelaciones de paradas de trenes. Una vez evaluado, solo se selecciona e implementa una alternativa de resolución de conflictos.

Además, una vez que las combinaciones están libres de conflictos, se evalúan de acuerdo con la información ya valorada de cada resolución de conflicto utilizada para derivar la combinación libre de conflictos. Esto se complementa con una evaluación de los desequilibrios inducidos al final del día (es decir, vehículos que terminan sus funciones en ubicaciones de la red que no son compatibles con las operaciones programadas para el día siguiente) y cambios en las estaciones de giro de los trenes. Finalmente, habiendo comprobado la idoneidad de cada combinación libre de conflictos, el sistema puede seleccionar y mostrar la mejor alternativa.

En última instancia, la contribución avanzada en la segunda sección de este trabajo sienta las bases para un despliegue semiautomático de los conceptos operativos DRP en la situación operativa real de la red. El sistema dinámico de implementación de DRP está estrictamente diseñado para mantener la rápida transición de la red hacia operaciones estables. Si bien el sistema está diseñado para redes ferroviarias de cercanías, puede emplearse independientemente de su entorno de implementación local.

Acknowledgements

First of all, I would like to thank Prof. Dr.-Ing. Andreas Oetting for giving me the opportunity to pursue a doctorate in the field of railway engineering and for supporting me at every step in the development of this work. I also would like to thank Prof. Dr.-Ing. Ullrich Martin for taking the time to review and comment on this document. Additionally, I would like to thank Mr. Wolters (DB Netze) and Mr. Kremer (DB Regio) for all your time, for the great discussions, and insights into disruption-management, which were invaluable to the development of this work.

I would like to thank all my friends at the Institute for Railway Engineering for the great working atmosphere. Sharing the workplace with all of you was terrific. I would like to thank each one of you for all the support and exchanges that made this work what it is. Especially, I would like to thank Anna who introduced me into the field of disruption-management and was always there to provide great advice. Also thanks to Sven, Rene and Istvan for all the interesting conversations regarding dispatching and exciting non-work related experiences. Thanks to Peter for all its care and always making time to lighten the mood. Thanks to Cedric, Bilal, Frederik, Sebastian, Katharina, Max, Adriana, Miroslav, and Christian. Without you this experience would not have been the same. I would also like to thank Sabine, Tatjana and Anette for taking so much care of all of us, your support was vital to finishing this work.

I would also like to thank all my friends at KRITIS. All of you made this experience unique and special and I learned something from each and every single one of you. Alice, thanks for providing so much motivation throughout all these years. You were an amazing office-mate. Kristof, thank you for taking care of me and for sitting down and listening to me talk about disruption-management. Marcel, thank you very much for all the interesting discussions and jokes we shared throughout these three years. Marcus, thank you for making my time in the office so great and for always being willing to give me a hand with any problem. Chris, thank you for your support and advice with the algorithms. Ben and Nadja thank you for your friendship and all the interesting conversations over coffee. Allegra, thanks for so many laughs and for making the office a fun space.

Additionally, I would also like to give a special thanks to my friends - old and new: Christian and Daniel who have been there throughout the highest and lowest moments in my life. Thanks to Fred and Nayara who became an essential part of my life in Europe. Pablo, thank you for all of the advice and for sharing the excitement along this journey.

I would like to give a special thanks to my mother and my father who made me into the person I am and guided me at every step of my personal and professional development. All that I am, I owe to them. From the bottom of my heart, I would also like to thank Alexandria, who was always there whenever I needed support and courage. This work would not be what it is without your love, help, understanding and all your precious revisions. I want to thank my siblings Amalia, Polec and Diego who stood beside me always and made sure I was able to get the job done. Finally, I want to thank my grandparents Elena and Arturo who are the source of all my inspiration and who have always placed all their faith in me and my abilities. This work is especially dedicated to all of you.

Arturo Crespo Materna



Contents

1. Introduction	1
1.1. Critical Infrastructures	1
1.2. The relevance of Preparedness & Prevention Strategies for Critical Infrastructures .	1
1.3. Motivation for an Enhancement of P&P Strategies within Railway Networks	3
1.4. Overall Purpose of the Work	5
2. Literature Review and State-of-the-Art	7
2.1. Overview	7
2.2. General Railway Transport Management Principles.....	8
2.3. Disruption-Management in Railway Operations.....	35
2.4. Passenger Transport Compensation During Disruptions -- Transport Concept.....	52
2.5. Closing Remarks ..	65
3. Objectives and Overall Approach	67
3.1. General Objective.	67
3.2. Specific Objectives	68
3.3. Content Limitation	70
3.4. Requirements.....	73
3.5. Methods.....	78
3.6. Basic Terminologies	96
3.7. Definitions Utilized within this Work.....	115
3.8. Structure of the Work	123
4. Model for Estimating the Public Transport Residual Capacity	125
4.1. Introduction.....	125
4.2. Key Determining Variables Influencing the Residual Capacity Estimation	126
4.3. General Approach Towards the Estimation of the Residual Capacity.....	129
4.4. Scrutiny of Operational Information - OR Validation and Function Assembly	136
4.5. Development of a General Public Transport Residual Capacity Estimation Model	155
4.6. Implementation and Example.....	164
4.7. Conclusions and Discussion of the Model	167
5. System Inputs	169
5.1. Infrastructural Information	170
5.2. Original Schedules and Circulation Plans	174
5.3. Disruption Programs (DRPs)	175
5.4. Disruption Information	177
5.5. Closing Remarks ..	180

6. Elemental Conflict Solution Alternatives	181
6.1. Introduction	181
6.2. Structured Examination Approach	182
6.3. Evaluation of the Elemental Conflict Solution Alternatives.....	184
6.4. Bundles of Elemental Conflict Solution Alternatives for Line-specific Conflicts....	221
6.5. Elemental Conflict Solution Alternatives for Vehicle-Specific Conflicts	227
6.6. Closing Remarks... ..	230
7. DRP Set-up	232
7.1. Introduction	232
7.2. Existing Approach for the DRP Set-up.....	232
7.3. Enhancement of the Existing Approach the DRP Set-up	233
7.4. Closing Remarks... ..	239
8. Line-Specific Conflict Identification and Establishment of Potential Solution Alternatives	241
8.1. Introduction	241
8.2. Establishing the Determining Variables to Identify Line-Specific Conflicts	242
8.3. Structured Approach for the Identification and Classification Process	245
8.4. Line-Specific Conflict Identification and Classification	248
8.5. Sorting and Construction of a Conflict List for all Line-Specific Conflicts.....	271
8.6. Closing Remarks... ..	273
9. Development of Potential Vehicle Specific Conflict Solutions in Time and Space (PVSCS)	275
9.1. Introduction	275
9.2. Structured Approach for the Development of PVSCS.....	277
9.3. Establishing the Investigation Order for Trains	281
9.4. Isolating Potential Handling Alternatives for an Investigated Train	283
9.5. Development of the PVSCS	291
9.6. Verification of the Technical Feasibility of PVSCS	302
9.7. Verification of the Operational Feasibility of PVSCS.....	304
9.8. PVSCS Set Arrangement	310
9.9. Closing Remarks... ..	311
10. Assembly of PVSCS Combinations	313
10.1. Introduction.....	313
10.2. Requirements and Limitations for the Combination of PVSCS	314
10.3. Structured Approach for the Combination of PVSCS.....	317
10.4. Establishing an Initial PVSCS Combination.....	324
10.5. Optimal Entrance Sequence – Tabu Search.....	328
10.6. Combination of the PVSCS – Genetic Algorithm	341
10.7. Closing Remarks	352

11. Vehicle-Specific Conflict Detection and Resolution (CDCR) Processes	354
11.1. Introduction	354
11.2. Requirements and Limitations for the CDCR Process.....	354
11.3. Structured Approach for the CDCR Process	356
11.4. Identification of Vehicle-Specific Conflicts and Conflict List Generator.....	360
11.5. Development of Vehicle-Specific Conflict Resolution Alternatives	370
11.6. Closing Remarks	397
12. Assessment of Conflict Resolution Alternatives and Fixed PVSCS Combinations	399
12.1. Introduction	399
12.2. Structured Approach for the Assessment of the Conflict Resolution Alternatives	400
12.3. Determining Variables for the Assessment of the Conflict Resolution Alternatives and the PVSCS Combination.....	410
12.4. Assessment of PVSCS Combinations.....	449
12.5. Closing Remarks	451
13. Adjustment and Selection of the Conflict-Free Schedule	454
13.1. Introduction	454
13.2. Structured Approach.....	455
13.3. Adjustment of the Conflict-Free Schedules.....	458
13.4. Closing Remarks	477
14. Exemplary Application of the System	479
14.1. Introduction	479
14.2. Scenario	479
14.3. DRP Set-up	486
14.4. Line-Specific Conflict Identification and Establishment of Potential Solution Alternatives.....	490
14.5. Development of PVSCS.....	499
14.6. Combination of PVSCS.....	512
14.7. Vehicle-specific CDCR Process.....	519
14.8. Assessment of Conflict Resolution Alternatives and Fixed PVSCS Combinations	532
14.9. Adjustment and Selection	535
14.10. Summary.....	539
15. Summary and Conclusions	540
15.1. Summary.....	540
15.2. Conclusions	543
16. General Outlook	546
Bibliography	547
Table of Figures	561
Table of Tables	566

Table of Symbols and Variables	569
Section 1 - Model for Estimating the Public Transport Residual Capacity	569
Section 2 – Dynamic DRP Deployment System	570
Acronyms and Abbreviations	580

1. Introduction

1.1. Critical Infrastructures

The habitability of dense urban centers can only be sustained by securing steady access to basic services. From drinking water to sewage collection, access to roads, railways or communication networks - all make life within cities possible (Godschalk 2003).

Infrastructures are considered ‘critical’ in nature when the roles they fulfill (e.g. health, safety, transport, etc.) are vital to maintaining basic societal functions, security, and the overall wellbeing of the population they service (O’Rourke 2007, Bach et al. 2013). The prominence of critical infrastructures is such that if any of their functions ceases to be performed as intended, the local population is forced to deal with extremely precarious circumstances. Consequently, it is crucial to uphold and safeguard the constant operational integrity of critical infrastructural systems, particularly in the face of any external or internal hazards.

Critical infrastructures are characterized among the most complex systems and therefore are often susceptible to the occurrence and manifestation of a broad range of hazards (Johansson and Hassel 2010). Their complexity derives from the fact that they cover vast geographical areas, cluster a broad range of distinctive components, rely upon complicated operational processes and are deeply interlaced with socio-economical functions (Chelleri et al. 2015).

The complexity of critical infrastructures also makes them particularly susceptible to a broader range of risks, ultimately hindering their capacity for adaptation (O’Rourke 2007). It is commonly understood that risk mitigation is an adept way to cope with the unexpected manifestation of such events. However, safeguarding critical infrastructures and their service reliability has been described as a dynamic process that transcends the notion of vulnerability reduction, demanding stronger or more robust infrastructures (Godschalk 2003) achievable through the development of preparedness and prevention (P&P) strategies (Crespo et al. 2018).

1.2. The relevance of Preparedness & Prevention Strategies for Critical Infrastructures

Introduced as “Distributed Preparedness” throughout the first half of the twentieth century in the context of critical infrastructures (Collier and Lakoff 2008), the term “preparedness and prevention” has laid the groundwork for current emergency or disaster risk, management frameworks (i.e. preparedness, prevention, response and recovery) (King 2007). Furthermore, preparedness and prevention have been essentially considered as one conjoined concept, which is frequently packaged within discussions on the term “mitigation” (King 2007).

P&P strategies have been understood to lie at the crux of any system’s ability to handle the manifestation of atypical and ominous events as they inherently recognize the inescapable possibility of an impairing incident (Collier and Lakoff 2008). In this regard, P&P strategies prompt a set of policies, plans or strategies intended to handle and diminish the overall reach as well as the occurrence probability of a disaster (Haimes et al. 2008). A further interpretation of P&P strategies expands their focus to embody an enhanced management tool of emergencies and a proficient path towards achieving some degree of operational continuity in cases of failure or disruption (Hémond and Robert 2012). Core notions introduced by P&P strategies, such as the operational continuity of critical infrastructure are at the core of the broader resilience agenda (Bach et al. 2013).

In the context of this work, resilience is approached through the broad framework provided by Bach et al. (2013), as it delivers insightful interpretations for the concept as a whole. Within the infrastructural realm, the authors describe resilience not only as a characteristic that enables systems to regain or maintain their original functions in the shortest time possible after the manifestation of a disruption (bouncing back), but furthermore as having the capacity to preserve service qualities and adjust while retaining adequate interactions with other systems (Bach et al. 2013). Nonetheless, such an appreciation lacks the acknowledgement of what scholars refer to as a continuous learning and uncertain evolutionary process proclaimed over the basis of adaptable persistence (Folke et al. 2010, Chelleri et al. 2015, Hémond and Robert 2012). Therefore, critical infrastructure resilience must take account of the ability of these systems to cope with external forces, adapt to sudden changing conditions and uphold as many service capabilities as possible, while also building up transformative, learned or evolutionary capacities.

The combined reach and further appreciation of P&P strategies within a resilience framework are quite broad and has not been fully asserted within the critical infrastructure debate (Haines et al. 2008, Hémond and Robert 2012, Mattsson and Jenelius 2015, Crespo et al. 2018). However, two relevant understandings employed in describing the association of these two concepts can be identified.

On the one hand, P&P strategies have been portrayed as static strategies that ought to be replaced by the development of a resilience-related agenda (Hémond and Robert 2012, p.412). Based on such understanding, P&P strategies are characterized as a set of rigid protocols that follow a strict timeline and serve as a rigid framework preserving the pre-existing character of the system. Consequently, P&P strategies are assumed to prevent the ability of the system to foster authentic adaptive capacities (Hémond and Robert, 2012). This flaw illuminates the principal reason why P&P strategies ought to be replaced by a more resilience-related framework.

On the other hand, P&P strategies are described as active assets within a resilience framework, which can be complemented with additional capabilities (i.e. effective response, adaption) (Haines et al. 2008; Mattsson and Jenelius 2015, p.20). In this regard, P&P strategies are explained to constitute critical components within the resilience framework, as they are aimed at protecting the integrity of the system's overall service capabilities, playing the role of decisive enablers of adaptable capabilities following shocks (Haines et al. 2008, Mattsson and Jenelius 2015, Crespo et al. 2018). Within this understanding, the key notion of "acceptable level of functioning" emerges (Hémond and Robert, 2012, p.413). To appreciate the "acceptable level of functioning," one must consider it as a back-up level that galvanizes the current characteristics of the system, as maintained by the first understanding. However, the "acceptable level of functioning" also presupposes that degraded operations may eventually take place, leading to the understanding that failure is unavoidable, and that clear strategies are needed to adapt the system to deal with its imminent disruption. In the context of critical infrastructures, dealing with degraded operations means adapting complex systems to a broad range of unknown operating conditions. Consequently, P&P strategies secure the link between stable and degraded operations, while ensuring that the affected critical infrastructure is able to attain an "acceptable level of functioning" within an unknown degraded state, ultimately, protecting the welfare of its users.

Both perspectives reveal the importance of P&P strategies within the context of critical infrastructure debates. The first perspective brings attention to the strict nature of P&P strategies and reveals the need for the development of more resilient qualities. However, the first perspective also places limited significance on the way in which P&P measures are able to boost the ability of

critical infrastructures to ensure operational continuity, which simultaneously permits exploring new adaptive potentials.

It must be recognized that if the strategies or protocols provided by P&P were not in place, systems would not be able to maintain serviceability in the early moments of a disruption, restraining its adaptive capacities and endangering user welfare. The immediate consideration when developing P&P strategies must, therefore, carefully explore critical operating conditions. Without this, it would be impossible to contemplate ideas of system transformability, adaptability and resilience. Conclusively, P&P strategies ought to be understood as catalysts inside the critical infrastructure resilience framework.

1.3. Motivation for an Enhancement of P&P Strategies within Railway Networks

The important role played by mass transport systems within the urban fabric places great pressure on safeguarding their reliable service capabilities. A deeper appreciation of transport systems indicates that they can ultimately define or influence a wide array of urban structures (Newman and Kenworthy 2015).

Transport systems, especially those servicing densely populated areas, are critical infrastructures intended for the uninterrupted functioning of society. In cities around the world, globalization has reinforced the unavoidable necessity to construct large, complex, and interconnected mass transportation systems so as to enable a more efficient transfer of passengers, goods, services and ideas (Tamvakis and Xenidis, 2012). As Newman and Kenworthy explain, mass transportation systems ultimately: “...*facilitate economies to create wealth while reducing automobile dependence [...] enabling sustainable development, increasing livability and reducing poverty...*” (2015, p.77).

Railway networks provide a particularly relevant example of mass transportation systems, and commuter railway networks are especially significant in urban areas. The growing prominence and intricacy of cities oblige commuter railway systems to operate dense schedules to satisfy existing transport demands (Newman and Kenworthy 2015). The efficiency and tremendous hauling capabilities of the commuter railway system means that they play a strategic role within local transport structures (Newman and Kenworthy 2015).

A precise example of the prominence of commuter railway systems as critical infrastructure is captured by the German commuter railway networks known as the “S-Bahn”, which are present throughout most of the country’s major urban areas. The large number of passengers served by these networks makes their consideration of particular relevance. In Berlin alone, the S-Bahn network services 1.3 million passengers every working day, managing a network of 327 Km with 166 stations (S-Bahn Berlin GmbH n.d.). These numbers are comparable with S-Bahn networks in other German metropolises. For example, in Munich, the “S-Bahn” transports 840 thousand people every day and manages a network of 530 Km and 150 stations (DB AG n.d.a).

In contrast to the relevance of railway systems within the urban environment, the stability of their operations is persistently threatened by the systems’ own compound and convoluted character (Jespersen-Groth et al. 2009).

As in the case of most critical infrastructures, railway systems cover large geographical areas, and their operations are only possible due to their interdependency with other infrastructures (Johansson and Hassel 2010). For example, the operations of an electrified railway system are supported by an interplay between civil infrastructures (i.e. tracks, bridges, tunnels, etc.), electrical

infrastructures, and telecommunications infrastructures (Hansen and Pachl 2014). Their extensive geographical coverage, together with the widespread assembly of dissimilar elements and processes (e.g. stations, tracks, switches, vehicles, personnel, passenger traffic, signals, operation control, schedules, etc.), poses an excessive burden on the control and maintenance procedures required for their operation.

For example, within their core routes, S-Bahn lines operate at very high frequencies and follow tight transport quality specifications. The system's efficient and effective service capabilities are made possible through a combination of very dense operational programs, the extensive and complex interplay of infrastructural elements, and vehicle operations, which enable the system to move users without interrupting regular city functions. In most cities, the S-Bahn trunk lines traverse the urban areas through tunnels (e.g. in Frankfurt, Stuttgart) or elevated passes and bridges (e.g. Berlin), where their operations gain complexity due to the intricacy of the infrastructure. Any complication occurring in these sections can radically hinder the capacity of the entire network, thereby impacting the urban area as a whole.

Consequently, managing railway network operations becomes a highly composite undertaking influenced by ever-changing external conditions, new interdependencies, as well as an extensive array of internal components that require close oversight (Tamvakis and Xenidis 2012, Reggiani et al. 2015, Nielsen et al. 2012). For these reasons, railway systems are exceedingly vulnerable and face the impending probability of failure as a part of their most fundamental and inescapable nature. Since potential failures in railway systems are imminent, and their relevance within the urban environment is paramount, the consideration of operational continuity in the midst of disruptive events is essential.

The magnitude and intricate character of railway systems makes them prone to a multitude of potential vulnerabilities. A simplified representation of the hazards most likely to affect critical infrastructures, and in particular railway systems, is displayed in figure 1.1. These threats are portrayed within four railway dimensions (i.e. infrastructural, traffic operation & control, signalling and energy).

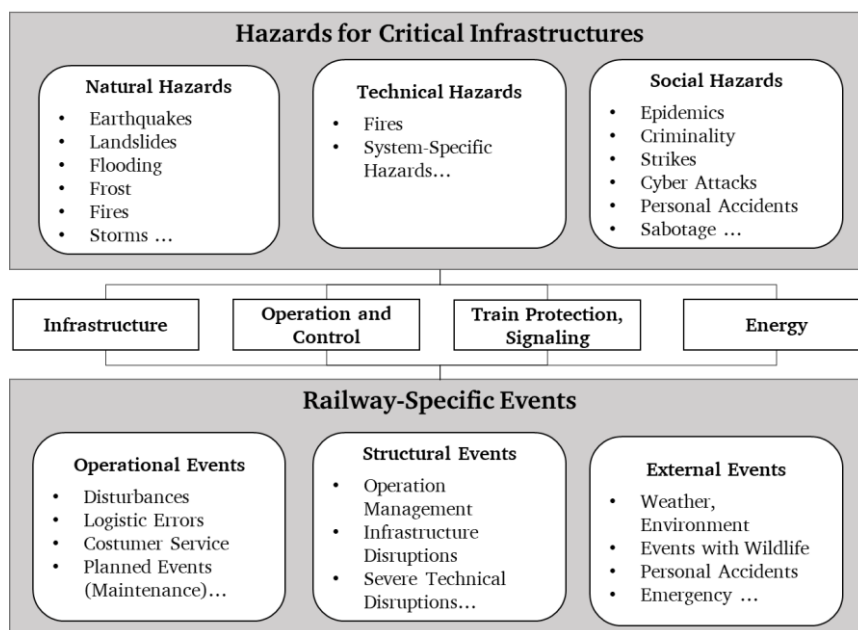

Figure 1.1 Overview of possible disruptions for critical infrastructures and railway operations (Dorbritz and Weidmann, 2012, as cited in Chu 2014)

Much attention has been paid towards the way in which the complexity of railway systems poses an immediate threat to stable operations. An exploration into the causes of disruptions on railway networks has demonstrated that around 50% of the disruptions are caused by internal operational problems (e.g. vehicle problems or lack of staff), whereas the other 50% is the result of external events or indirect infrastructural breakdowns (Jespersen-Groth et al. 2009). In response, railway infrastructure managers and transport operators have put forward different approaches aimed at instituting more resilient system services. The most conventional measures focused on enhancing the infrastructural sphere apply physical interventions such as flood protection walls, expanding the drainage or endeavouring to improve station designs (Silla et al. 2014). Nevertheless, tackling issues of traffic control and other operational aspects of railway services are just as necessary.

Within railway operations, it is common knowledge among practitioners that the systems' composite conditions allow for disruptions to spread rapidly over space and time and create what they call "knock-on" effects. Knock-on effects refer to the way in which the deviance of a single train service from its original schedule can echo throughout the entire network, causing significant cumulative effects (Jespersen-Groth et al. 2009). The systems' high physical and operational complexity severely limits its physical adaptability and stresses the need for enhanced operational coping mechanisms. Thus, any debate on resilience in railway systems should not only focus on their capacity to physically withstand shocks, but also the capacity of the system to remain or regain operational capabilities by adapting to the circumstances of a disruption (i.e. P&P strategies).

Maintaining continuous operational qualities requires the uninterrupted availability of highly specialized resources such as experienced dispatchers, clear dispatching rules, contingency plans, communication technology, etc. Given that disruptions in railway operations can occur due to different causes, staff members need to be well prepared to address any induced situation (Chu 2014; Nielsen et al. 2012). In the event of sudden disruptions, decision-makers (e.g. dispatchers, signallers, drivers) take and communicate critical decisions in short periods of time and within stringent and uncertain conditions (Nielsen et al. 2012). These decisions ultimately have a ripple effect that can influence the efficiency of the whole network and inevitably have an impact on passenger welfare (Ghaemi et al. 2016). Thus, managing the challenges and returning the system to planned operations demands great skill and determination.

Disruptions in railway operations are addressed within the framework of disruption-management. Disruption-management involves the adjustment of the train service schedule as well as the rolling stock and crew schedules (Jespersen-Groth et al. 2009). Different approaches to disruption-management tasks depend on the local context (Schipper and Gerrits 2018). Regardless of the approach, decision-makers count with P&P strategies, be they in the form of bundles of dispatching rules or detailed sets of contingency plans (Schipper and Gerrits 2018).

1.4. Overall Purpose of the Work

This work seeks to emphasize the relevance of P&P strategies as a means to foster resilience in critical infrastructures. Railway networks serve as the object of study since they are regarded as among the most complex of critical infrastructure systems (Johansson and Hassel 2010) and their prominence within urban environments has been steadily rising over the past few decades (Newman and Kenworthy 2015).

More specifically, this work strives to enhance existing P&P strategies to improve the management of disruptions in railway operations. Upholding the operational continuity of railway systems lays the foundation for the further advancement of resilient capabilities in an interdependent and complex critical infrastructure.

In the following section, the literature research has two general aims. Firstly, it introduces fundamental concepts and methods in railway transport management, cataloguing state of the art approaches from existing research regarding the management of operational disruptions. Secondly, it identifies voids within prominent P&P strategies supporting the management of disrupted railway operations.

2. Literature Review and State-of-the-Art

2.1. Overview

As discussed in section 1, railway systems are characterized by their multidimensional nature and regarded as large dynamic, interdependent and complex systems (Chu 2014). Their extensive geographical coverage, together with their widespread assemblage of different elements and processes, requires complex operating and maintenance procedures. Consequently, managing railway networks becomes a highly composite undertaking that requires close oversight. For these reasons, railway systems are prone to the occurrence of events that interfere with their regular operations, thus, affecting its users.

The interference of railway operations may be categorized by the amount of delay induced by the occurring events throughout the network (Jespersen-Groth et al. 2009). Marginal deviance from the existing schedule may be merely regarded as a disturbance. However, if an incident generates extensive variations across the planned operations (e.g. interrupting the general flow of vehicles throughout a section), it may then be regarded as a disruption (Jespersen-Groth et al. 2009). Railway disruptions are events characterized by producing substantial amounts of delays and service cancellations throughout the network; as a result, they are said to impose a substantial burden over railway passengers.

Since the rerouting and rescheduling of railway vehicles is a much more complicated task than it would be among its rubber-based counterparts (e.g. buses or personal motorized vehicles), dispatchers must take critical and complex decisions within stringent and uncertain circumstances in short periods of time. These decisions become highly relevant to the efficiency of the whole network, affecting passenger welfare to different extents (Ghaemi et al. 2016). Operationally, the decisions fall within one of the three disruption-management problems, namely, schedule adjustment, rolling stock rescheduling, and crew rescheduling (Jespersen-Groth et al. 2009). However, every modification on the operational level would also affect the passenger transporting capabilities of the disrupted system, and thus, on passengers' welfare (Brauner and Oetting 2019).

To uphold both the operational and the passenger transport quality during a disruption and swiftly address the degraded operational circumstances, decision-makers partially rely on the availability of specialized resources (e.g. experienced dispatchers), and in some cases on contingency plans (e.g. communication protocols, decision-support software, disruption programs, etc.). Consequently, the development of enhanced support mechanisms (i.e. P&P strategies) for disruption-management is of central importance, as they allow dispatchers to rapidly draft and develop solutions that are better suited to address the actual situation, reducing the potential for reactions based on subjective factors.

After providing a general overview of the general principles behind railway transport management, from the perspective of railway operations research (discussed in subsection 2.2), the current section endeavours a detailed exploration of the existing disruption-management approaches. In subsection 2.3, both ad-hoc and planned disruption-management approaches, including state of the art regarding available methods and models, are discussed in extensive detail. Subsection 2.3 also provides an overview of the relevance regarding the systematic handling of the disruption from both operational and passenger transport related perspectives. Later, in subsection 2.4, the capability of railway systems to uphold its serviceability and foster its passenger transport adaptive capacities and passenger rerouting strategies is also discussed. The section concludes in subsection

2.5 with a summary of the most relevant disruption-management aspects and the identified research gaps.

2.2. General Railway Transport Management Principles

This subsection discusses the general principles behind railway transport management. More specifically, it discusses the overall structure behind railway operational investigations, laying the groundwork for later addressing disruption-management approaches and models.

Overall, railway operations research calculations allow describing the relationship between infrastructure utilization and schedule or service quality (Oetting 2019). As depicted in figure 2.1, the general approach behind railway operations research calculations may be outlined as an input and output process, where there is a convergence of three basic input parameters (i.e. operating program including model trains, infrastructure model, and the delay as well as time reserves) that together support the planning and monitoring of railway operations (Oetting 2019).

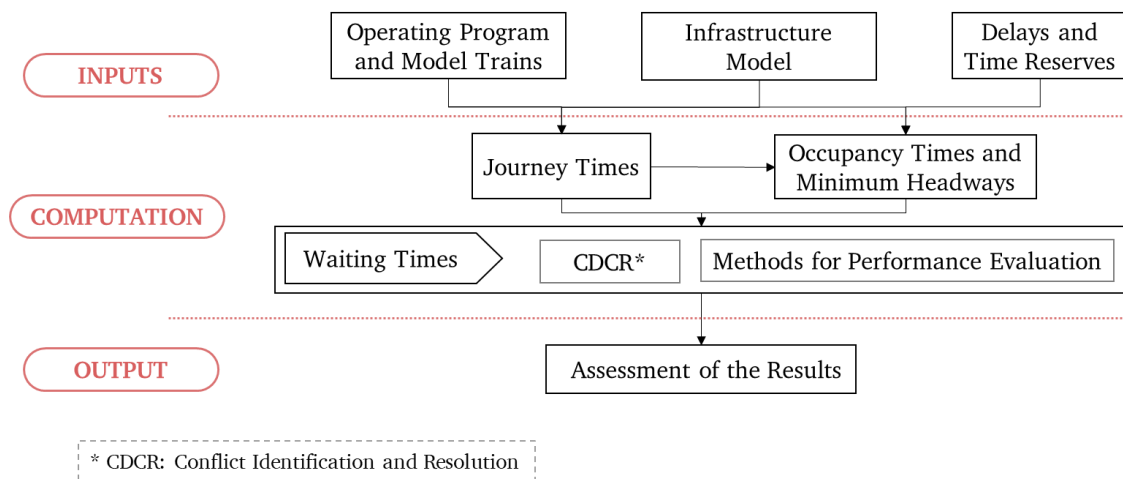

Figure 2.1 General approach for railway operations research calculations (Oetting 2019, modified by author)

The logical structure depicted in figure 2.1 is one among many means to generalize the analysis of railway operations. Different alternatives aimed at describing the logical structure behind railway operations research calculations are provided in: D’Ariano (2008) or Pachl (2018). Nonetheless, the framework depicted in figure 2.1 covers most of the existing alternatives.

The three input parameters allow to determine the driving times, occupancy times and minimum headway times, which at the same time permit to establish the scheduled waiting times during planning stages and the non-scheduled waiting times for trains during the monitoring of real-time operations. There is a broad range of approaches that allow ascertaining the waiting times, and ultimately, lay the groundwork for their assessment. From heuristic methods based on practical dispatching rules to analytical methods founded over queuing theory, different methods can be utilized to fulfill the tasks that are required throughout the planning of railway operations as well as their monitoring in real-time.

The assessment of results is inherently related to the task at hand. Within planning stages, for example, during the strategic planning of the railway network or the construction of the schedule, the assessment focuses are: efficient utilization of the network capacity, acquiring a robust schedule, which enables a reduced propagation of delays (i.e. assessing the punctuality), decreasing costs, and increasing the service quality (D’Ariano 2008). Within the monitoring of

operations, the assessment focuses on the impact of different traffic management measures during technical failures or in case of train delays, which lead to spatial and temporal conflicts between trains (D'Ariano 2008).

The following subsections provide a detailed discussion on the input parameters and computational processes that are particularly relevant for grasping in full extent the existing models that deal with disruption-management. Particular emphasis is given to use cases that facilitate the ability of the network to return to its originally scheduled operations. Initially, the operating program and model trains are discussed; later, the infrastructure modelling and the different models available are detailed. Subsequently, the process and available models for conflict identification, conflict resolution, and assessment of the resolution alternatives, are introduced. Ultimately, the methods for performance evaluation and the foundation are discussed.

The remaining computational processes to calculate journey times, occupancy times, and minimum headway are addressed throughout the following subsections of this document, however, the following literature may be reviewed for further insights within these processes: Wende (2003), Hansen (2009), Pachl (2018), Hansen and Pachl (2014). On the other hand, the modelling of delays as well as the time reserves (including operational buffer times) is not directly addressed in the following subsection; thus, it is recommended to revise the following literature: Schwanhäuser (1974), Nie and Hansen (2005), Büker and Seybold (2012).

2.2.1. Operating Program and Model Trains

Railway operations can be summarized as the movement of trains through a given network; in most cases, this implies a simultaneous use of the infrastructure, where the basic operational rules or constraints must be met. The German railway infrastructure manager provides a concrete definition for an operating program in its guideline RIL-405.0102: *“The operating program is the data description of all operational processes and characteristics of the transport units involved in these operations.”* (DB Netz RIL-405 2009, p.5 [own translation]).

Initially, a UIC (International Union of Railways) report explains that: *“Rail transport demand is steadily expanding worldwide, in particular in metropolitan areas with soaring populations. Even in Europe where population growth is slower, forecasts show a rise in the railway share of transport.”* (UIC 2015, p.9). The increasing demand for railway services brings about an increase in the number of passenger and freight train services that need to be planned and monitored within a moderate growth in infrastructure availability. The increasing number of train services, together with the utilization of different vehicle types, entails a latent increase in complexity across both planning, monitoring, and controlling tasks. However, since trains of similar or identical vehicle types may be appointed to use the same or relatively similar routes, trains may be grouped into model trains (or train families) (Vakhtel 2002). The utilization of model trains introduces significant advantages to railway operations management (see Vakhtel 2002, p.98).

Operating Program

Operating programs contain information regarding all train services, including shunting operations that take place in the railway network under consideration (DB Netz RIL-405 2009). The most concrete form of an operating program is a railway schedule.

In overall, as described in guideline RIL-405 from the German railway infrastructure manager (DB Netz RIL-405 2009), the information contained within an operating program is explained to be constituted by:

- Number train services (per line) within a defined time period
- The interval between train services (per line)
- Train properties (e.g. train length, train mass, speed, driving dynamics, etc.)
- Structure (e.g. train order, number of train services within a given model train)
- Routes (e.g. beginning and end stations) and stopping patterns
- Train classes (e.g. long-distance passenger train, freight train) and overtakes
- Passenger transport requirements

A more thorough description of these elements and their use in different planning levels or tasks can be found in Cao (2017, p. 25-26).

Depending on the stage of planning, the operating program may contain the information listed above with different granularity. The granularity may range from generalized information regarding the number of train services planned for a specific line within a defined time period to a fully established schedule that outlines the predictable movement of train services throughout the infrastructure (Hansen and Pachl 2014).

Furthermore, a common form of operating program is introduced by cyclic schedules. Cyclic schedules repeat themselves within a defined time period, which is generally accounted for in hourly intervals. Since cyclic schedules are easier to follow on behalf of railway user, the operating programs of passenger lines are mainly planned as cyclic schedules (Hansen and Pachl 2014).

An overview of a cyclic schedule is depicted in figure 2.2, where its two central features are clearly portrayed. First, the cycle time t_c , which is explained as the time between the successive departure of the same vehicle or vehicle composition from the same station. Second, the fixed time interval between two train services of the same line, which is ultimately referred to as service interval t_{SI} (Hansen and Pachl 2014, p.43).

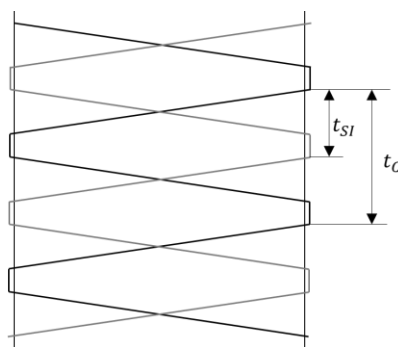

Figure 2.2 General example of a cyclic schedule, including the cycle time and service interval (source: Hansen and Pachl, 2014, modified by author)

Within a cyclic schedule, deriving the required number of vehicle or vehicle compositions needed to run the operating program may be easily obtained. As detailed by Hansen and Pachl (2014), the number of vehicle or vehicle compositions needed n_T is acquired by dividing the cycle time t_c by the service interval t_{SI} , as generalized in equation 2.1.

$$n_T = \frac{t_c}{t_{SI}} \quad (2.1)$$

As they are the most straightforward example of an operating program, cycle schedules are introduced to depict and generalize the underlying features discussed thus far. Existing approaches for the handling of cyclic schedules, particularly during the planning phases are discussed in Huisman et al. 2005, Liebchen (2007).

Nonetheless, contingent on the utilization of different vehicle or vehicle compositions appointed to the train services outlined in the operating program, the required computational processes may grow in complexity (i.e. increase in the number of vehicles and vehicle compositions with different driving dynamics interacting with one another). Under these circumstances, the grouping of trains into train models constitutes an adept and crucial generalization.

Model Trains

As detailed in guideline RIL-405 of the German railway infrastructure manager (DB Netz RIL-405 2009), model trains result from identifying train services with similar characteristics (in the operating program) and grouping them so that their handling may be generalized. The central benefit introduced by model trains is the reduction in the dimension of the input data and its redundancy; this is particularly beneficial for the computation of journey times (Vakhtel 2002).

At the outset, different characteristics may be contemplated to group a train into a given model train. The approach introduced in Brünger (1995) and later complemented by Vakhtel (2002) provides a very comprehensive overview of the different characteristics that may be contemplated for grouping purposes. The approach has been advanced for its utilization within analytical methods, relying on three groups of characteristics:

i) Physical characteristics:

- Train identification
 - Train number
 - Train Class (e.g. regional or long-distance passenger trains, freight trains, etc.)
 - The automatic train protection system
- Driving dynamics
 - Type of the traction unit (e.g. diesel or electric)
 - Train length, mass, number of wagons (if applicable)
 - Acceleration and speed characteristics (e.g. most frequent top speed)
 - Breaking performance

ii) Routes:

- Similar routes within the investigated area
- Similar stopping patterns within the investigated area

iii) Association with other train services

- Service interval
- Representative days of operation for the train service
- Number of train services comprised by the model

Each of the characteristics that have been listed is further detailed in Vakhtel (2002, p. 100-103).

As a general rule, the German railway infrastructure manager in its guideline RIL-405.0102 explained that: “*is sufficient to define model trains for a few combinations of mass, traction unit and train length*” (DB Netz RIL-405 2009, p.4 [own translation]). During the grouping process, it is recommended that model trains with less than 5% of the total number of trains in the operating program within the defined time period are checked once again to ascertain whether if it is possible

to reassign them into other model trains (DB Netz RIL-405 2009). Finally, it is also recommended that a model train should not contain less than three trains as outlined by the operating program under consideration (DB Netz RIL-405 2009).

2.2.2. Infrastructure Modelling

As discussed in subsection 1.3, railway infrastructures are a highly complex and interconnected array of elements that support the railway operations. Through different modelling techniques, infrastructure models allow abstraction of a convoluted series of infrastructural elements so that the railway operations can be planned, and real-time operations can be monitored.

Infrastructure models are the basis for the computational tasks involved in the planning and monitoring of railway operations (Hansen and Pachl 2014). Overall, it is common practice to use the building blocks of graph theory to engender an abstract representation of railway infrastructures irrespectively from the complexity of the network being modelled (Radtke and Watson 2007). Consequently, railway infrastructures are primarily modelled through a series of nodes and links (node-link models), which may be appointed a broad range of attributes (e.g. maximum speed, gradient, length, etc.).

The techniques to model the infrastructural elements of a railway network can be generalized in three main groups, namely, macroscopic, microscopic and mesoscopic modelling techniques. Each of these groups is related to the degree of detail in which the infrastructural elements are being modelled. A thorough description of each of these modelling techniques can be found among others in: Radtke and Hauptmann (2004), Huber and Wilfinger (2006), Radtke and Watson (2007), Gille et al. 2008, Hansen and Pachl (2014).

Primarily, macroscopic models allow handling entire railway networks within a minimal complexity. Every element in the macroscopic model, whether it is a node or a link, contains an aggregated version of the information across all infrastructural elements it represents. In typical node-link models, a macroscopic node aggregates all infrastructural elements that constitute a station regardless of its size. The same is valid for links between two nodes, which aggregate the information of all railway lines between stations (Radtke and Hauptmann 2004). As a result, macroscopic elements are appointed with common attributes, for example, average block lengths, speed limits, or gradients. The simplicity makes macroscopic models an adept modelling technique to address problems such as vehicle circulation planning or long-term traffic planning (Gille et al. 2008). While including different infrastructural elements into one single macroscopic element allows deriving a much simpler model of the railway network, it also comes with the risk of a considerable loss of accuracy due to an oversimplification.

In microscopic modelling, each infrastructural element is represented through a single node or link, depending on the approach. In typical microscopic models, all tracks are assigned link elements, including tracks traversing the stations. On the other hand, the position of signals or switches can be ascertained with considerable accuracy thanks to node elements (Hansen and Pachl 2014). Microscopic infrastructure modelling techniques generate highly reliable models, as gradients, block lengths or changes in speed limits can be modelled with accuracy. Consequently, this modelling technique is compulsory for most planning tasks (e.g. computation of journey times, schedule planning), yet its level of detail and complexity limits its implementation in cases where the computational time is of the essence (e.g. real-time rescheduling) (Hansen and Pachl 2014).

Mesoscopic infrastructural models can be positioned with respect to their modelling degree of detail between the two above-discussed techniques. Mesoscopic models limit the complexity of the resulting infrastructural model while, at the same time, allow a strategic inclusion of certain aspects that enhance their reliability. For instance, according to Gille et al. (2008), one of the biggest obstacles posed by the use of macroscopic models is the simplicity with which they handle train route exclusions in railway stations or junctions. Mesoscopic models address this issue by integrating strategic information within their node elements. Therefore, Gille et al. (2008) argue that a mesoscopic model comes into fruition only if it can support the following two features:

1. Reachability: the modelled station (as a node) must carry information regarding which platform track can be reached from which link. Like this, the switching zones in the station can be mapped.
2. Route exclusions: the modelled station (as a node) must allow determining, which train runs are able to take place simultaneously, and, which induce a conflict.

A particularly relevant mesoscopic infrastructure modelling framework has been introduced in Oetting and Griesse (2016a, 2016b). The authors establish an enhanced macroscopic model able to support the monitoring of real-time operations. Due to the proficiency of the modelling framework, its capabilities are further explained throughout the following paragraphs.

Overall, the authors introduce a framework that merges the baseline capabilities of a mesoscopic infrastructure modelling technique with algorithms that allow computing journey times as well as minimum headway times with an element-specific granularity thanks to the incorporation of model trains. As a result, the enhanced macroscopic infrastructure model permits conducting conflict identification and conflict resolution processes much faster and accurate than with traditional macroscopic models (Oetting and Griesse 2016a).

The modelling technique introduced by Oetting and Griesse (2016a, 2016b) can be summarized by discussing the modelled elements and their appointed attributes. The modelled elements are differentiated in three general groups, namely, model trains, nodes, and links.

i) Model Trains

In the modelling framework proposed by Oetting and Griesse (2016a, 2016b), link-specific differences in long-distance railway services as well as in local railway services are the central aspects to consider when grouping trains into model trains.

The grouping of trains is carried out link-specific focusing on the train class and the driving as well as the stopping patterns of every train. As a result, the proposed framework recommends the formation of six different model trains. The model trains displayed in table 2.1 derive from the five model trains introduced in Wendler and Nießen (2005). However, Oetting and Griesse (2016a) introduce an additional model to distinguish slow local/regional passenger services.

Table 2.1 Model Trains (by author)

Model Train		Meaning in German	Meaning in English
PFV	PFV-S	Personenfernverkehr -“schnell“	Long-distance passenger service – “fast”
	PFV-L	Personenfernverkehr - “langsam“	Long-distance passenger service – “slow”
PNV	PNV-S	Personennahverkehr -“schnell“	Local/Regional passenger service – “fast”
	PNV-L	Personennahverkehr - “langsam“	Local/Regional passenger service – “slow”
GV	GV-S	Güterverkehr -“schnell“	Freight service – “fast”
	GV-L	Güterverkehr - “langsam“	Freight service – “slow”

The first column in table 2.1 provides the abbreviation utilized in the approach to identify each model train. The second column details the meaning of such abbreviation in German and in the third column, its English equivalent is presented (Oetting and GRIESE 2016a, p.4).

Among other characteristics described in subsection 2.2.1, the grouping process takes place for passenger services based on the journey times, and for freight traffic based on the maximum speed of the train. For example, for passenger traffic, the travel times of all trains per service (e.g. PFV, PNV) on every link are derived as a density function. If this function has two separated maxima, the model trains for the considered service on the respective links are divided into two models (i.e. slow or fast), otherwise one (Oetting and GRIESE 2016a).

The journey time for the trains are introduced from microscopic models or other available sources, and algorithms that allow generalizing and making the information compatible with the framework are also provided. Furthermore, the additional times required for acceleration (to reach the top speed) and deceleration of every model train (e.g. for the stopping at nodes) are also considered. The calculation of these additional times is conducted by distinguishing between the characteristics of every model train (i.e. differentiating between electro and diesel traction units) and assuming a parameter of 3%, which considers the sum of all track resistances (Oetting and GRIESE 2016a, p.5).

ii) Links

The modelling framework introduced by Oetting and GRIESE (2016a, 2016b) foresees links as all elements between two nodes (i.e. junctions and stations). These elements are appointed with eight fundamental attributes, and the most relevant of these attributes are:

- Electrified (Yes/No)
- Number of tracks
- Maximum train length
- Maximum train mass
- Possible bidirectional operation on each track (Yes/No)
- Restriction/Priority (for every train category)

For a detailed description of each of the attributes, refer to Oetting and GRIESE (2016b, p.76).

In the proposed modelling framework, as in most mesoscopic and macroscopic models, the links aggregate information of different infrastructural elements. Potential infrastructural elements which may be incorporated into a link are, for example, beginning, and end of block sections, signals, changes in track gradients, etc. (see Oetting and GRIESE 2016a, p.2). Nevertheless, each of the incorporated elements is still able to convey particular attributes, a characteristic, which allows enhancing the reliability of the resulting model. The best example for such an advantage is the ability to locate each of the incorporated elements within the link in correspondence to a track's driving direction (e.g. location of signals, beginning, and end of block sections, etc.).

Furthermore, minimum headway times are not usually supported in macroscopic or mesoscopic modelling approaches. However, in the modelling framework introduced by Oetting and GRIESE (2016a, 2016b), link elements are complemented with algorithms that allow an automatic computation of the minimum headway times. Minimum headway times on a link may be computed based on the journey time information between the nodes. The journey time information is specific for every model train, and as explained above, it may be derived from different sources (e.g. schedule or other microscopic models) (Oetting and GRIESE 2016a, p.3).

The minimum headway is calculated for the respective model trains, as displayed in equation 2.2 (Oetting and Griese 2016a, p. 9). The minimum headway time $t_{minHT_{i,j}}$ between train i and j , may be ascertained by determining the maximum value of the sum of the journey times $t_{f,i,k}$ of train i across the block sections $k - 1$ plus the actual occupancy time $z_{haupt,i,m}$ of train i in block m plus the pre-blocking time $z_{vor,j,m}$ of train i in block m minus the sum of the journey times $t_{f,j,k}$ of train j across the block sections k . In equation 2.2, the pre-blocking time $z_{vor,j,m}$ results from the sum of the route setting time t_{fb} , signal visibility time t_{sicht} and approach time t_{an} (see also Hansen and Pachl 2014, p.24).

$$t_{minHT_{i,j}} = \max_{m=1,\dots,n} \left\{ \sum_{k=1}^{m-1} t_{f,i,k} + z_{haupt,i,m} + z_{vor,j,m} - \sum_{k=1}^{m-1} t_{f,j,k} \right\} \quad (2.2)$$

Equation 2.2, has been conceived to support its implementation in a mesoscopic infrastructure model; thus, the resulting minimum headway times refer to the trains' departure time from a node and not to the beginning of the blocking time itself (Oetting et al. 2011, as cited in Oetting and Griese 2016a).

Ultimately, during the computation of the minimum headway time on a link, the minimum headway times respective to: the route through the switching zone leaving the node at the beginning of the link until the link's first main signal (in German: Hauptsignal), and the minimum headway time beyond the home signal (in German: Einfahrsignal) respective to the end node of the link, must be considered (see point *iii*) Nodes).

iii) Nodes

The modelling framework introduced by Oetting and Griese (2016a and 2016b) foresees the representation of nodes as in the approach introduced in Wendler and Nießen (2005). Wendler and Nießen (2005) propose the modelling of junctions and stations in the railway network by considering two components, namely, switching zones and platform tracks.

The enhanced modelling framework appoints fourteen attributes across both node components, which are distributed in the three main groups as detailed below.

Attributes for the whole node:

- List of links adjacent to the node
- Matrix of relations (Matrix Rel)
- Tracks of the adjacent link in the station without a platform
- List of the platform track groups and platform track (including numbers)
- Train protection system available
- Distance properties of the adjacent links (Matrix – S)

Attributes specific to switching zones:

- List of switching zones
- Matrix of reachability (Matrix E)
- Matrix of conflicts (Matrix K)
- Matrix of velocity (Matrix V)
- Distance properties for the switching zone (Matrix L)
- Matrix of total occupations (Matrix Z)

Attributes specific to platform track groups:

- Distance properties for the platform track groups and platform tracks
- Matrix of total occupations (Matrix Z)

Each of the node attributes is discussed in further detailed in Oetting and Griesse (2016b, p.182-189).

The modelling framework supports the capability to represent the reachability between specific tracks within a link and platform tracks within a node by appointing a matrix of relations (Matrix Rel) as well as the matrix of reachability (Matrix E). Likewise, it supports the capability to represent pairwise route exclusions through the switching zones by attributing them with a matrix of conflicts (Matrix K). Consequently, the modelling framework covers all essential features of a mesoscopic node element, as detailed by Gille et al. (2008).

Furthermore, just as link elements, node elements are also complemented by algorithms that support an automatic computation of minimum headway times.

Minimum headway times are computed separately for switching zones and platform track elements by utilizing pre-blocking times z_{vor} and occupancy times z_{haupt} . The means to ascertain the pre-blocking times z_{vor} and the occupancy times z_{haupt} in nodes is generalized in equations 2.3 and 2.4 (Oetting and Griesse 2016b, p.196). The computation of the pre-blocking times z_{vor} is, in principle, ascertained as discussed for link elements. However, the occupancy time z_{haupt} is computed as the sum of the journey time in the common route section t_{kn} that also includes the clearing time, plus a release time t_{fa} .

$$z_{vor} = t_{fb} + t_{sicht} + t_{an} \quad (2.3)$$

$$z_{haupt} = t_{kn} + t_{fa} \quad (2.4)$$

Due to the existence of different driving patterns through a node, the modelling framework observes different cases to ascertain both the pre-blocking and occupancy times. Three driving patterns are taken into consideration, namely, arrival, departure without a stop in the node (drive-through) and departure with a stop in the node.

In order to ascertain the pre-blocking times in switching zones, the driving patterns under consideration are said to affect the approaching time t_{an} (Oetting and Griesse 2016b, p.194). For an arrival to the node, t_{an} is recommended to be equal to the journey time in the track between the distant signal (in German: Vorsignal) and the home signal. For the departure from the node without a stop, t_{an} is recommended to be equal to the journey time between the home signal and the exit signal (in German: Ausfahrtsignal). For the departure from the node without a stop, t_{an} is recommended to be equal to the journey time between the stopping position and the exit signal. Ultimately, in order to determine the pre-blocking times in the platform track, t_{an} is ascertained as described for switching zones and respective to the driving pattern, which considers a train's arrival and departure to and from the node.

Furthermore, in order to determine the occupancy time z_{haupt} , the driving patterns under consideration are said to affect both the total journey time t_{kn} and the clearing time throughout the node. However, in this case, different train combinations must also be considered. Consequently, the computation is conducted for a combination of $f1$ and $f2$ (i.e. first and second trains, respectively) (Oetting and Griesse 2016b, p.194-195).

For switching zones the t_{kn} and the clearing time is determined for the two first driving patterns since platform track groups generally englobe more than one platform track.

- For an arrival of $f1$ to the node, the t_{kn} is equal to the journey time between the home signal and the platform track's stopping position through the respective route on the switching zone plus the length of the train $f1$.
- For a departure of $f1$ from the node, two cases are recognized:
 - If train $f2$ is not foreseen to drive through the same track on the adjacent link the t_{kn} is equal to the journey time of $f1$ from the exit signal through the switching zone plus the length of the train $f1$.
 - If the train $f2$ is foreseen to drive through the same track, the t_{kn} is equal to the journey time of $f1$ between the exit signal through the respective route on the switching zone until the clearing point past the first main signal of the link plus the length of train $f1$.

The occupancy time z_{haupt} for the switching zones is computed by introducing the journey time t_{kn} respective to the driving pattern in equation 2.4.

For platform tracks, the t_{kn} and the clearing time is determined by differentiating between the departure and arrival of the first train from the node.

- For a stop of $f1$ in the node after its arrival, the $t_{kn,arr}$ is equal to the journey time between the home signal and the stopping position at the platform track.
- For a departure of $f1$ from the node after its stop, the $t_{kn,dep}$ is equal to the journey time between the stopping position at the platform track and the clearing point passed the exiting signal of the link plus the length of train $f1$.
- For $f1$ driving through the node without a stop, the t_{kn} is equal to the journey time between the home signal and the clearing point passed the exiting signal plus the length of train $f1$.

The occupancy time z_{haupt} for platform tracks according to the different driving patterns is ascertained as summarized in equations 2.5 and 2.6.

$$z_{Haupt} = t_{sicht} + t_{kn,dep} + t_{fa} \quad (2.5)$$

$$z_{Haupt} = t_{kn,arr} \quad (2.6)$$

The total occupancy time z for the different driving patterns and train combinations is ascertained, as summarized in equation 2.7. However, for calculating the total occupancy time z for platform tracks of trains departing or starting their service at the node, the variable z_{vor} does not exist as it has already been considered in the respective driving pattern (i.e. $t_{kn,dep}$).

$$z = z_{vor} + z_{Haupt} \quad (2.7)$$

The total occupancy time in the platform tracks does not include the stopping time t_{stop} of a train, which can be adjusted by the user (Oetting and Griese 2016b, p.233).

Ultimately, the total occupancy times are summarized in a matrix of total occupations (matrix Z) for every switching zone and platform track group or platform track in the node (Oetting and Griese 2016b, p.197).

2.2.3. Conflict Identification and Conflict Resolution (CDCR)

As discussed in subsections 1.3 and 2.1, due to the complexity of railway systems, disturbances in their operations take place frequently. The disturbances induce conflicts between trains that must be pre-emptively identified and resolved by adjusting the existing schedule. Hansen and Pachl explain that in overall addressing disturbances entails: “[...] *identifying and solving train conflicts, while minimising the train delay propagation and maximising the dynamic utilization of railway capacity.*” (2014, p.262).

Approaches based on the identification and resolution of train conflicts have been mainly utilized as a part of decision-support systems allowing dispatchers to address disturbed real-time operations. This task has been aptly labelled as the: Conflict Detection and Conflict Resolution problem (CDCR) (D’Ariano 2008). Decision-support models framed within CDCR principles, have not only been advanced for real-time traffic management (i.e. rescheduling) as in Oetting et al. (2013) or Kuckelberg (2011), but also for schedule construction (i.e. planning) purposes as in Chiang et al. (1998) or Oetting et al. (2011). This subsection provides an overview of existing CDCR models and a discussion regarding the most important aspects that support their ability to address the planning or the management of disturbed railway operations.

At the outset, the CDCR principles handle conflicts across different operating circumstances, for example, conflicts between trains, the infrastructure as well as with the operating program. Together, the different conflicts can be recognized and grouped in specific conflict types. There are four fundamental conflict types often handled by CDCR approaches, namely, occupancy conflicts, infrastructure availability conflicts, circulation conflicts, and connection conflicts (see Pferdmenges and Schaefer 1995; Hansen and Pachl 2014). Figure 2.3 provides an overview of each of the four fundamental conflict types.

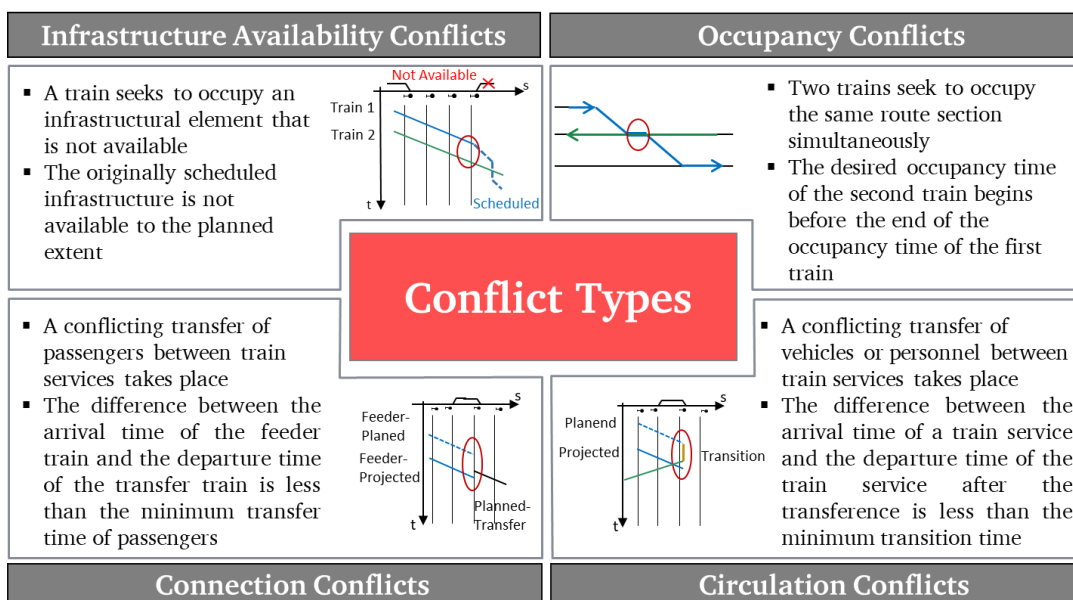

Figure 2.3 Overview of the fundamental conflict types (Pferdmenges and Schaefer 1995, as cited in Oetting 2019; modified by author)

The management of the four fundamental conflict types is divided into the two central steps that constitute the CDCR approach, namely, the identification and the resolution of conflicts. Bär (1996) explains that within each of these steps, further processes take place, ultimately, instituting the conflict-management framework.

i) Conflict Identification (CD)

In the conflict identification process, potential conflicts are identified within a given time period (Hansen and Pachl 2014). The time period depends on the implementation context; for example, for the monitoring of real-time operations, conflicts are identified for a given time horizon (e.g. 15 minutes ahead from the actual time) (Hansen and Pachl 2014).

Furthermore, within the conflict identification process, conflicts may also be classified so that their resolution can be conducted with further knowledge of the operating situation in which they have taken place (Neuber 2017).

Further insights in the conflict identification process are discussed in detail in the works of: D'Ariano (2008), Pachl (2018), Hansen and Pachl (2014) and Neuber (2017), among others.

ii) Conflict Resolution (CR)

The conflict resolution process addresses the identified conflicts by introducing the necessary adjustments on the existing schedule in such a way that the resolution is compatible with actual train delays and the condition of the network (Hansen and Pachl 2014). More specifically, conflict resolution involves the introduction of spatiotemporal adjustments in the schedule of the conflicting trains (D'Ariano 2008).

The existing models may be distributed into those that mainly employ heuristic approaches and those that rely on other methods (e.g. exact methods). The most relevant models able to address the four different conflict types among these two general groups are discussed in the following subtitles. Ultimately, due to the importance of the overall process, a detailed discussion regarding the assessment of conflict resolution alternatives within heuristic approaches is also provided.

CDCR based on Optimisation Approaches

CDCR processes based on optimization approaches utilize mainly exact methods to compute near-optimal conflict-free schedules (Hansen and Pachl 2014). Models based on optimization approaches provide a detailed exploration of the problem and derive potential solutions that are specifically tailored to address that actual situation.

CDCR processes based on optimization approaches have been developed to support both the planning and real-time monitoring of railway operations, across all four discussed conflict types.

Occupancy and Infrastructure Availability Conflicts

Şahin (1999) utilizes CDCR principles formulated as a job-shop scheduling problem to address occupancy conflicts during real-time operations. The model identifies and resolves conflicts synchronously within a time-horizon and incorporates look-ahead capabilities to evaluate its developed conflict resolution alternatives. The conflict-management is supported by a heuristic algorithm and solved through a mixed-integer linear programming model that seeks to minimize the average generated delays.

Törnquist and Persson (2005) introduce a two-level iterative approach to address occupancy conflicts within real-time operations. The first level in the approach seeks to optimize through a linear programming model the allocation of start and end times of all assessed trains and the block sections they are foreseen to occupy. The second level derives the order of trains through junctions and overtakes through Tabu search or Simulated Annealing algorithms.

Rodriguez (2007) proposes a model that relies on constraint programming and simulation techniques to resolve occupancy conflicts. The model supports the scheduling and rescheduling of trains through junctions and stations utilizing branch and bound strategies within very stringent computational times.

D'Ariano (2008) presents a dispatching support system with the capability to perform real-time rescheduling due to the occurrence of disturbances. Utilizing an alternative graph model, and some heuristic methods, the system divides the CDCR problem into two sub-problems. First, the model addresses the ordering and timing of trains through the infrastructure, also taking into consideration its availability. Second, with the results from the first problem, the model deals with the possible rerouting alternatives. The first problem is addressed through a truncated branch and bound technique, which seeks to minimize the induced delay. The second problem is solved through a Tabu search algorithm, which allows exploring different routing strategies and improves the results obtained from the first sub-problem.

Caimi et al. (2012) propose a closed-loop discrete-time control system to address the occupancy conflicts by generating spatiotemporal solutions. The solutions are attained through a linear optimization model based on blocking time theory while respecting connection constraints and platform track changes with the objective of maximizing customer satisfaction. The solutions are projected onto the actual operating circumstances and displayed to dispatchers as time-distance graphs.

Pellegrini et al. (2014) introduce a model that allows addressing occupancy conflicts based on the blocking time theory detailed in Hansen and Pachl (2008). The model utilizes a mix integer linear programming to ascertain the best possible spatial and temporal modifications for trains affected by a disturbance, seeking to minimize the induce delay.

Corman and Quaglietta (2015) present an approach to complement existing CDCR models, which function as decision-support mechanisms for the monitoring of real-time operations (e.g. the system introduced in D'Ariano, 2008). The approach bridges the gap between the rescheduling algorithms and the necessary projection of the operational environment, which is utilized to develop and assess the proposed solutions. The approach introduces stochastic deviations into the projections so that they can better reflect actual operating situations.

Circulation Conflicts

Schrijver (1993) addresses the circulation planning of trains and proposes a model to satisfy passenger demand by optimizing the number of rolling stock units (i.e. traction unit plus wagons) appointed to the scheduled train services. Utilizing a directed graph, the number of rolling stock units is optimized through integer linear programming.

Ben-Khedher et al. (1998) address the problem of adjusting the allocation of vehicles (i.e. modular units that have the traction unit attached to a series of articulated wagons) within vehicle compositions (i.e. a set of coupled vehicles) based on an updated schedule. The model is aimed at high-speed train services. The vehicle allocation uses an event graph model coupled with operational constraints (e.g. the number of vehicles available, the maximum number of vehicles appointed to combinations and station storage constraints) and access to the seat reservation system to determine a new circulation plan for the trains with new vehicle compositions. The problem is solved through integer linear programming, seeking to maximize the operating profit within a time horizon.

Peeters and Kroon (2003) introduce a model to establish the circulation of rolling stock units for a given line or on a set of corresponding lines following a given schedule. The proposed model utilizes a branch and price algorithm to appoint rolling stock units to train services in the daily schedule. The solutions are assessed based on the number of seats which are made available, robustness, and the cost of the resulting circulation plan.

Fioole et al. (2006) extend the model of Peters and Kroon (2003) to support the coupling and decoupling of train services along the lines or set of corresponding lines. Additionally, the authors also consider the existence of different cycle variants, which refer to the presence of line branches with different lengths.

Alfieri (2006) proposes a model to derive an efficient circulation plan for vehicles based on an integer multi-commodity flow model. The model has similar capabilities as previously discussed approaches; however, for coupling and decoupling purposes, it takes into account the order of the vehicles within the vehicle compositions. This feature is particularly useful to derive an efficient circulation plan for lines that schedule several coupling and decoupling operations.

Haahr et al. (2016) propose a model that is better suited to real-time operations and is targeted at assigning different vehicle compositions to a schedule that needs to be adjusted due to a disturbance. The modification of the circulation plans is achieved by allowing vehicle compositions to be coupled or decoupled while taking into consideration the order vehicles in the composition. Furthermore, the problem is solved through a mixed-integer linear programming model that seeks to minimize the number of kilometres driven as well as the shortage of seating availability for passengers and ensure that the circulation plan for the next day schedule may be fulfilled (minimize the end-of-day imbalance, see also Nielsen 2011).

Connection Conflicts

Ginkel and Schöbel (2007) introduce a model to address connection conflicts due to a delay in the feeder train. The authors utilize an alternative graph model and integer linear programming founded over a discrete trade-off between time and cost in project networks, extending an objective function that includes passenger delay and the number of broken connections.

Sparing und Goverde (2012) utilize delay propagation methods based on Max-Plus algebra to evaluate connection conflicts within cyclic schedules. The model makes it possible to evaluate for different delay scenarios, the effects of guaranteed connections on the stability of the schedule. The model's evaluation function takes into account passenger delay due to broken connections and arrivals. The model can be implemented to assess existing schedules or in real-time situations by introducing the actual delay in the system.

Lemniam et al. (2014) introduce a model which allows identifying and classifying connection conflicts in real-time. By modelling the railway network through an event-activity network and introducing an on-line delay propagation using historical distributions, railway operations are monitored, and connections conflicts are identified. Later, a classification technique based on fuzzy logic allows classifying identified connection conflicts and providing the information to dispatchers.

Discussion

The models reviewed within this subtitle cover both the planning as well as the monitoring of real-time operations through different optimization approaches. This can be evidenced by contrasting

the modelling of real-time occupancy conflicts as a job-shop scheduling problem detailed in Şahin (1999) or the branch and price algorithm utilized to plan the circulation of railway vehicles detailed in Peeters and Kroon (2003).

Regardless of the conflict type being addressed, a majority of the discussed models rely on the utilization of exact methods. In particular, linear programming has been utilized consistently to address every conflict type, for example: Ginkel and Schöbel (2007), D'Ariano (2008), Caimi et al. (2012) or Haahr et al. (2016). While exact methods conduct a very detailed exploration of the problem and deliver solutions with considerable quality, they require robust and complex frameworks (e.g. Pellegrini et al. 2014). In order to curb the complexity and maintain their practical relevance, the models focus on one the handling of one specific conflict type or incorporate general simplifications (e.g. simplified objective functions). The best example is the absence of a model framed within exact methods that is able to support the handling of more than one conflict type simultaneously.

Whereas in the planning phase, computational times and efficiency are not of the essence, during real-time operations, the models must support the ability of dispatchers to react to the situation swiftly. Therefore, the practical relevance of models that rely on exact methods is further compromised as the complexity of the disturbance increases and the event turns into a disruption (see subsection 2.1). D'Ariano clearly highlights this problem and explains: “[...] *the level of disturbance and the complexity and density of the railway network are other important time consuming factors to be taken into account during the traffic prediction, since in case of severe disturbances a large number of trains are involved in conflicting situations and more decisions need to be made. Further research should therefore be dedicated to the analysis of more sophisticated techniques of problem decomposition in order to fill the gap between solution quality and computation times for more complicated and densely used railway networks [...]*” (2008, p.171).

CDCR Based on Heuristics

CDCR processes based on heuristic approaches include models that are founded over rule-based or existing metaheuristics approaches (e.g. Tabu search). Due to their flexibility, heuristic approaches have been mainly, but not exclusively, exploited to constitute decision-support systems for real-time operations.

In many heuristic approaches, there is a clear distinction between the identification and the resolution of conflicts as two distinct processes (e.g. Chiang and Hau 1995, Jacobs 2004 or Oetting et al. 2011).

Within the identification process, conflicts are usually identified, classified and sorted into one single conflict list. For a detailed discussion regarding the comprehensive identification and classification of conflicts based on heuristic approaches, refer to Fay (1999), Oetting et al. 2013, or Neuber (2017).

Within the resolution process, conflicts are resolved systematically by addressing the conflicts already sorted in the conflict list. Overall, conflicts can be solved either synchronously or asynchronously (Oetting et al. 2011). An asynchronous approach solves conflicts contingent on given rules, for example, the priority of the trains involved in the conflict. On the other hand, synchronous approaches would consider primarily the temporal occurrence of the conflict, making them prone to result in deadlock situations (Pachl 2007).

Additionally, there are some approaches that address the identified conflicts through the development and assessment of a series of conflict resolution alternatives. The resolution alternatives may be developed utilizing predefined elemental conflict solutions and a simulation or projection of the existing traffic (Oetting et al. 2013). The number of the resolution alternatives being developed and the extent to which they are assessed depends on the nature of the conflicts being handled and the proficiency of the model (e.g. the number of predefined elemental conflict solution strategies available).

A broad range of models that support addressing the two central steps of the CDCR problem and their respective processes have been put forward. The main share of these models concentrate on the handling of occupancy conflicts, yet some examples also address other fundamental conflict types. While most techniques presented in these models are developed to deal with train conflicts that arise as a product of disturbances in the system or during the construction of the schedule, it is essential to consider them as they have laid the groundwork for the advancement of many disruption-oriented models.

Occupancy and Infrastructure Availability Conflicts:

Chiang and Hau (1995) introduce a model intended for railway schedule planning, which is based on a two-step repairing heuristic technique. The heuristic starts with a flawed schedule (i.e. not conflict-free), which appoints the trains random routes through the stations. Conflicts are then identified, stored in a conflict list, and resolved synchronously utilizing five elemental conflict resolution alternatives. For every conflict, the first step in the heuristic algorithm utilizes local search methods to explore routing options for the conflicting trains. The second step sharpens the solutions by exploring optimal routes through stations and temporal modification using a hybrid metaheuristic that combines Simulated Annealing and Tabu search algorithms. The resolution alternatives are assessed through an objective function that seeks to minimize the total running time of trains and the deviation on the starting time of each train, as foreseen in the flawed schedule.

Missikoff (1997) introduces a knowledge-based system intended for providing decision-support to dispatchers during real-time operations by means of an early identification and resolution of conflicts. The system conducts a short-term projection of the actual operations, which is utilized to identify and sort conflicts for their subsequent resolution. The user can decide if conflicts are sorted synchronously or asynchronously (i.e. using train priorities). Conflicts are systematically selected, and a series of conflict resolution alternatives are generated utilizing two elemental conflict solutions. Solutions are generated through enhanced searching techniques and a simplified look-ahead capability that retains the alternatives in a decision-tree. The alternatives are assessed based on a projected weighted sum of all train delays with respect to the train category.

Chiang et al. (1998) introduce a fully automated and asynchronous scheduling heuristic based on the two-step repairing heuristic proposed in Chiang and Hau (1995). The iterative approach generates an initially flawed schedule for all trains in one category, which is fixed through a CDCR approach before the next category of trains is introduced. The CDCR algorithms utilize five elemental conflict solutions and incorporate a knowledge-base that contains rules extracted from experts to resolve the conflicts. Due to its fully automated character, the conflict resolution heuristic is complemented by a redundancy elimination algorithm that identifies and removes unnecessary temporal shifts that have been appointed to trains as conflict resolutions. The process

is allowed to jump back in the conflict-free region and remove unnecessary temporal shifts from the schedule.

Jacobs (2004) introduces a decision-support system for the identification of occupancy conflicts based on blocking time theory. An overview of blocking time theory can be attained by referring to the work of: Pachl (2018) or Hansen and Pachl (2014). The utilization of blocking time theory (i.e. microscopic infrastructure representation) allows the model to develop highly reliable conflict resolution alternatives through the use of six different elemental conflict solutions. Conflicts are resolved asynchronously based on the category of the trains and various alternatives that seek to minimize the trains' running time. Finally, different resolution alternatives are provided to the dispatcher so that they can be selected.

Wegele and Schnieder (2004) utilize a series of metaheuristic approaches to address occupancy conflicts during real-time operations while also taking into consideration connection conflicts during the assessment. The CDCR problem is represented through an event-based Petri net, where resolution alternatives are generated asynchronously utilizing elemental conflict solutions. Resolution alternatives are first generated using combinatorial optimization algorithms (i.e. greedy algorithm, Tabu search, and Simulated Annealing) in parallel to find a starting point and narrow down possible decisions. The solutions are further optimized utilizing a particular set of functions, which are assessed through a penalty function that takes into account train delay, changes in platform tracks, and broken connections.

Oetting et al. (2011) introduce a model constituted by different heuristic algorithms that support the scheduling of trains (i.e. the planning phase). The algorithms are devised for a mesoscopic infrastructural model and address occupancy and infrastructure availability conflicts. The model's overall structure is constituted by an iterative and asynchronous CDCR approach that introduces trains from one category and solves all conflicts before the next category is added. The conflict identification is conducted differently between link elements and node elements. In link elements, the conflict identification is limited to two-train conflicts, which is later compensated by the model's look-ahead capability used in the evaluation of the conflict resolution alternatives. In nodes elements, across switching zones and platform tracks, conflicts are not limited to two trains, and the identification distinguishes between single over-occupation (two-train conflicts) and multi over-occupation conflicts (more than two trains in a conflict). The resolution alternatives are developed differently depending on the conflict that takes place in a node or a link, utilizing four elemental conflict solutions and supporting their combination. In links, resolution alternatives are developed, taking into consideration the minimum headway restrictions, and affecting the trains directly involved in the conflict. In nodes, a heuristic algorithm is introduced to develop conflict resolution alternatives depending if it is a single or a multi over-occupation conflict.

- *For single over-occupation*: the heuristic algorithm guarantees that each solution is conflict-free. Conflicting trains may be shifted in time at the platform track or at the home signal, or rerouted through the node. If the rerouting generates a conflict with other trains, the rerouted train is appointed an additional shift in time. All possible routing alternatives for the directly involved trains and time shifts are memorized. However, if no feasible solution is found until a limit in the time shifts has been reached (i.e. set by the user), the search area needs to be expanded to avoid deadlocks.
- *For multi over-occupation*: the same principles as in the previous case are also valid with some modifications. If the above-described exploration yields no conflict-free combination, potential solutions that still contain conflicts are further considered in the same step. The

exploration of these potential solutions is limited to single over-occupation conflicts (to limit computation time), where trains that were not directly involved in the conflict can also be affected by the elemental conflict solutions. Ultimately, if still no conflict-free combination can be found, the alternative that reduces the degree of over-occupation by at least one train is chosen, and the remaining conflicts are added to the list. If no combination is able to reduce the degree of over-occupation, the search area is expanded.

In the approach the resolution alternatives are assessed through an evaluation function that takes into consideration the weighted waiting time introduced to the trains, the weighted waiting time of the non-affected trains due to follow-up conflicts (look-ahead), a waiting time equivalent penalty value for changing the platform track, and only for links a penalty for solutions that curtail same direction bundling.

Corman et al. (2012) propose a detailed alternative graph model and two heuristic algorithms to address occupancy and circulation conflicts. The heuristic algorithms are based on the truncated branch and bound algorithm introduced in D'Ariano (2008) and the Pareto local search technique of Paquete and Stützle (2006). The overall structure entails an iterative CDCR process that is supported by the branch and bound algorithm and by assuming fixed connections, the Pareto local search framework is then applied.

Oetting et al. (2013) introduce a framework of a real-time decision-support system that supports the automatic identification and visualization of conflicts, where different resolution alternatives are developed synchronously. In the system, occupancy conflicts are identified within a microscopic modelled network, which allows their classification with respect to the operating situation in which they take place. The classification enables recognizing aspects like routes in the infrastructure that are common for all trains directly involved in the conflict. The resolution of conflicts relies on elemental conflict solutions, which are coupled with special heuristics that allow ascertaining with precision the temporal adjustments, such as the temporal shifts, stopping times, and bending factors. The assessment of the resolution alternatives supports a look-ahead capability by providing a framework to assess the likely impact of follow-up conflicts based on their severity. The evaluation function considers the expected relative-time changes (i.e. changes in the train's delay vis-à-vis the original schedule), the changes in the projected operating situation (change in conflict severity before and after the projected implementation of the resolution alternative) and any changes in platform tracks. The three determining variables are weighted and additively linked to constitute a modular evaluation function, which allows introducing further determining variables, such as energy consumption.

Neuber (2017) introduced a set of rule-based approaches to improve the identification of occupancy conflicts and the projection of train movements represented as time-distance graphs. Initially, an approach that allows the calculation of the driving dynamics respecting permissible speeds and boundary conditions throughout the scheduled routes is provided. Furthermore, a robust framework for conflict classification for two-train occupancy conflicts within microscopic models is introduced.

Circulation Conflicts

Budai et al. (2010) propose a model that allows adjusting the circulation plans due to the occurrence of disturbances in the system. The model represents the modification of the circulation plans as a single commodity network flow problem, allowing the coupling and decoupling of the vehicle compositions and imposing a limit on the resulting train lengths. The circulation plan is

addressed through an iterative two-step algorithm. The first step reassigns the vehicle compositions to different train services, seeking to acquire feasible compositions and reduce the number of vehicles that generate an end-of-day imbalance. The second step utilizes the alternatives generated in step one and further enhances them by performing coupling and uncoupling operations seeking to further reduce the end-of-day imbalance. The resulting alternatives are introduced in an integer linear programming model to select the circulation plans with minimum vehicle kilometres, seat shortage kilometres, and number of composition changes.

Miao et al. (2010) propose a heuristic algorithm to compute a circulation plan for vehicles while taking into account maintenance constraints. The approach is based on an alternative graph model where all possible circulations of vehicle compositions between train services detailed the schedule can be mapped out. Initially, a heuristic algorithm starts by allocating vehicle compositions with a circulation to the train services first scheduled to departure from the different stations. Later, a second heuristic algorithm exchanges the circulation to different train services while abiding with maintenance constraints like the number of inspections in time and maximum travelled distance between inspections. Potential solutions are assessed on the basis of the number of vehicle compositions needed for the resulting circulation plans appointed to the schedule.

Connection Conflicts

Kurby (2012) focuses its model on developing conflict resolution alternatives to address connection conflicts within real-time operations while taking into consideration the effects on further connections. The model relies only on two elemental conflict solution alternatives, namely, shifting the connecting train in time so that it waits for the feeder train (i.e. securing the connection) or breaking the connection (i.e. no shift in time for the connecting train). The resolution alternatives are projected on the operating situation and assessed by an objective function, which considers the total passenger delay.

Stelzer (2016) introduces a semi-automatic decision-support system to be utilized during real-time operations and perform a consistent identification and resolution of connection conflicts as well as an objective assessment of the conflict resolution alternatives. The system is conceived on a modular basis, where conflict identification, conflict resolution, assessment and selection of resolution alternatives are provided each with their own structured approach. The approach relies on heuristic as well as combinatorial algorithms and a robust logical framework to diagnose the operating situation of connection in the network and explore resolution alternatives utilizing more than ten different elemental conflict solutions. The evaluation function identifies the measure or set of measures that better satisfies the operating company's economic objectives.

Discussion

The models explored within this subtitle also support both planning as well as the monitoring of real-time operations by incorporating a broad range of different methodological approaches. For example, models like Chiang et al. (1998) or Oetting et al. (2011) that are entirely based on heuristic methods. Contrastingly, while other models like Budai et al. (2010) or Corman et al. (2012) are based on heuristic methods, they also incorporate optimization approaches to refine their solutions.

From the models entirely based on heuristic methods, the structure with which they are able to derive their solutions is of particular relevance. For example, models like Missikoff (1997), Chiang et al. (1998), Oetting et al. (2011), Oetting et al. (2013) or Stelzer (2016), introduce a very robust

framework to support the identification and systematic resolution of conflicts by taking close consideration of the actual operating situation in the network. These models develop their conflict solutions based on pre-defined elemental conflict solutions, which constitute standard spatiotemporal adjustments that are used to propose one or more conflict resolution alternatives (Oetting et al. 2013). The overall benefit of incorporating a set of pre-defined elemental conflict solutions to resolve the identified conflicts consists of allowing an automatic system to react reliably and generically to the actual operating situation (Stelzer 2016).

Furthermore, for the models based on heuristic approaches, the infrastructure modelling technique being utilized is also of importance. Depending on the degree of detail of the infrastructure modelling, the identification of conflicts and the pre-defined elemental conflict solution strategies incorporated in the system can be as precise as the ones discussed in Oetting et al. (2013) or broad as in Oetting et al. (2011).

In heuristic models are structured around a systematic resolution of conflicts (Chiang et al. 1998 or Oetting et al. 2013), a consistent and essential quality to be supported by their conflict resolution approaches are look-ahead capabilities (Oetting et al. 2011). Look-ahead capabilities allow taking into account the conflicts that may be induced on other trains due to the implementation of resolution alternatives (i.e. follow-up conflicts) during the assessment process.

Assessment of Dispatching Measures for Heuristic Decision-Support Mechanisms

As it has been discussed throughout the previous subtitle, some heuristic CDCR approaches incorporate predefined elemental conflict solutions (e.g. Chiang and Hau 1995, Missikoff 1997, Oetting et al. 2011, or Oetting et al. 2013), and resolve conflicts through the development of different conflict resolution alternatives. Regardless of the conflict type being addressed, these approaches require evaluation functions specifically tailored to assess the resolution alternatives, supporting the selection of one of the alternatives, as the proposed solution. As clearly pointed out in Stelzer (2016), securing the means to conduct an objective assessment of the alternatives is a critical aspect for ensuring the proficiency of the CDCR process.

After an exploration of the different CDCR models, a broad range of potential determining variables within a resolution alternative can be considered to conduct their assessment. The considered determining variables reflect the local or global influence of the conflict resolution alternative within the operating situation. The features which have been most utilized for assessment purposes are:

- The waiting times introduced by the resolution alternative (locally), the overall delay induced in the system (globally) or expected relative-time changes on every train (globally).
- Potentially induced waiting times due to follow-up conflicts with third trains (locally) or the changes in the projected operating situation (globally)
- Changes in platform tracks calibrated as waiting time equivalent penalties (locally)

Once these features are systematized in determining variables, they are weighted so that they can be compared with each other, constituting a modular evaluation function. In order to make the evaluation of the determining variables comparable, they must be conducted or expressed from a temporal viewpoint (i.e. expressed in minutes or seconds). The weighting of the determining variables can be conducted in correspondence to the approaches' implementing field (e.g.

dispatching objectives or rules), for example, Jacobs (2004) or Oetting et al. (2011) utilize train categories to derive the weight of the determining variables.

The approach introduced by DB Netz (2017) describes a framework to conduct the assessment of conflict resolution alternatives developed to address disturbed operations as part of a decision-support system for dispatchers in real-time. The framework has, at its core, a modular evaluation function that includes three determining variables as the one proposed Oetting et al. (2013), namely, the expected relative-time changes, changes in the projected operating situation and changes in platform tracks. The evaluation function and its respective determining variables (DV) are weighted and additively linked, as introduced in equation 2.8.

$$ER = \sum_{i=1}^i w_i * DV_i \quad (2.8)$$

Equation 2.8, generalizes the assessment framework introduced in DB Netz (2017); where the evaluation rate ER of a conflict resolution alternative is ascertained by the sum of three weighted w_i determining variables DV_i .

Within the framework introduced in DB Netz (2017), the means to ascertain and weight the expected relative-time changes are of particular significance. Overall, the expected relative-time of a train is ascertained through a difference between its projected time (actual time) $t_{Proj-Actu}$ and its scheduled time t_{Sched} (DB Netz RIL-420 2017). This expected relative-time $\Delta t_{Proj-Actu}$ is ascertained as generalized in equation 2.9.

$$\Delta t_{Proj-Actu} = t_{Proj-Actu} - t_{Sched} \quad (2.9)$$

The same principles are extended to ascertain the expected relative-time product of the implementation of a conflict resolution alternative, as generalized in equation 2.10.

$$\Delta t_{Proj-Res} = t_{Proj-Res} - t_{Sched} \quad (2.10)$$

Finally, the expected relative-time changes are ascertained as detailed in equation 2.11, which results from a difference between equation 2.10 and equation 2.9 (DB Netz 2017).

$$\Delta t_{Rel} = \Delta t_{Proj-Res} - \Delta t_{Proj-Actu} \quad (2.11)$$

In regular operations, the train's relative-time is projected and measured across a series of locations throughout its scheduled route with the purpose of ascertaining its punctuality (DB Netz RIL-420 2017). Therefore, the assessment of the conflict resolution alternatives takes place on the basis of the relative-time changes determined throughout a train's relative-time measuring points.

The assessment framework introduced in DB Netz (2017) foresees the weighting of the already ascertained relative-time changes Δt_{Rel} with respect to the dispatching objectives and rules applicable during disturbed operations as foreseen in their implementing filed (see DB Netz RIL-420 2017).

The German infrastructure manager guideline DB Netz RIL-420 (2017) outlines that in case of divergences from the schedule (i.e. disturbed operations) the central dispatching objective is the reinstatement of the original schedule, where the following dispatching rules apply (DB Netz RIL-420 2017 as referenced in DB Netz 2017):

-
1. Emergency trains have priority over all trains
 2. Trains on express-passenger slots have priority over all trains except emergency trains. Deviations from the rule are regulated by the network coordinator.
 3. Trains on Express-freight slots have priority over all trains except emergency trains and trains on Express-passenger slots. Deviations from the rule are regulated by the network coordinator.
 4. Trains not mentioned separately under points 1 to 3 are essentially equivalent to each other.
 5. For equivalent trains, faster trains always have priority over slower-moving trains (i.e. cruising speed).
 6. Trains on special railways (e.g. commuter railway trains) take precedence over other trains on these routes, provided they provide transport services for which the special railways are designated. Exceptions to this rule are emergency trains.

The DB Netz (2017) assessment framework finally weights the changes in the expected relative-time changes for a train through a weighting function that takes into consideration a train's priority and its delay before and after the projected implementation of the conflict resolution alternative in concordance with the dispatching objectives and rules. The implemented weighting function values trains according to the amount of delay they carry and their priority as detailed by the dispatching rules. For example, a change in the relative-time of plus five minutes would be weight much higher for a train on an Express-passenger slot that is close to being punctual (e.g. a delay of two minutes) than that of a non-express freight train that was already delayed for fifteen minutes before the implementation of the measure.

Summary

Through all discussed CDCR approaches, both planning and the monitoring of real-time operations can be successfully supported. These approaches provide with flexibility as they can be systematically coupled with different other methods to provide a robust evaluation framework. Nonetheless, across both reviewed clusters (i.e. optimization and heuristic-based approaches), there is very limited literature that supports the handling of more than one of the four conflict types at the same time.

At the planning level, existing CDCR approaches allow concentrating on specific operational processes (e.g. planning of vehicle circulation, planning of train connections) and their respective constraints so as to support the specific planning task (e.g. construction of the schedule, planning of circulation plans). As a result, the existing processes permit to highlight required modifications to the operating programs and derive a conflict-free schedule through, for example, the introduction of planned waiting times and or transition between train services.

During real-time operations, the discussed CDCR approaches also allow managing and monitoring specific operating situations (e.g. train connections, end-of-day imbalances); however, in this case, they rely on the existing schedules and circulation plans as a framework. Overall, the existing models could improve the efficiency and effectiveness of dispatching tasks since they allow a more detailed, less subjective, and uniformed dispatching process. As a result, the existing processes permit a swift draft of potential resolution alternatives to address trains affected by a disturbance, ultimately, appointing non-scheduled waiting times or introducing modifications to the circulation plans, etc.

2.2.4. Methods for Performance Evaluation

As explained in Hansen and Pachl: “Performance evaluation consist of a model of factors influencing the effect of rail transport by means of criteria and representative indicators. A comparison is made with reference to some subjective or valid standards for a given period of time.” (2014, p.275). It is particularly important to clarify further that while the utilized standards can be subjective or generally valid (e.g. punctuality of trains, punctuality of passengers or capacity consumption), they embody the quality of service, which is to be achieved by the railway operations.

The central objective of performance evaluation is to provide concrete information on the strengths and weaknesses of systems and their operating programs. Therefore, the specific parameters that are utilized to conduct the evaluation must be carefully chosen (Vakhtel 2002). An overview of these parameters vis-à-vis their influence on the quality of service is provided by the guideline of the German infrastructure manager DB Netz RIL-405 (2009).

Among the available parameters, the capacity consumption ρ has been mostly utilized for evaluating the performance of railway operations. Overall, capacity consumption embodies the number of trains that utilize the infrastructure within a given time period, which allows to clearly locate bottlenecks and capacity reserves throughout the network (Vakhtel 2002).

Furthermore, it has been very well documented that the higher the number of trains moving simultaneously throughout the infrastructure, the higher the probability of hindrances during their operations. This, in turn, leads to a higher sum of the waiting times (Schwanhäußer 1974, Martin and Chu 2013, DB Netz RIL-405 2009). Figure 2.4 portrays the waiting time function, where the sum of the waiting times is said to grow with the number of trains, converging to infinity as it approaches the maximum or throughput capacity (Hansen and Pachl 2014).

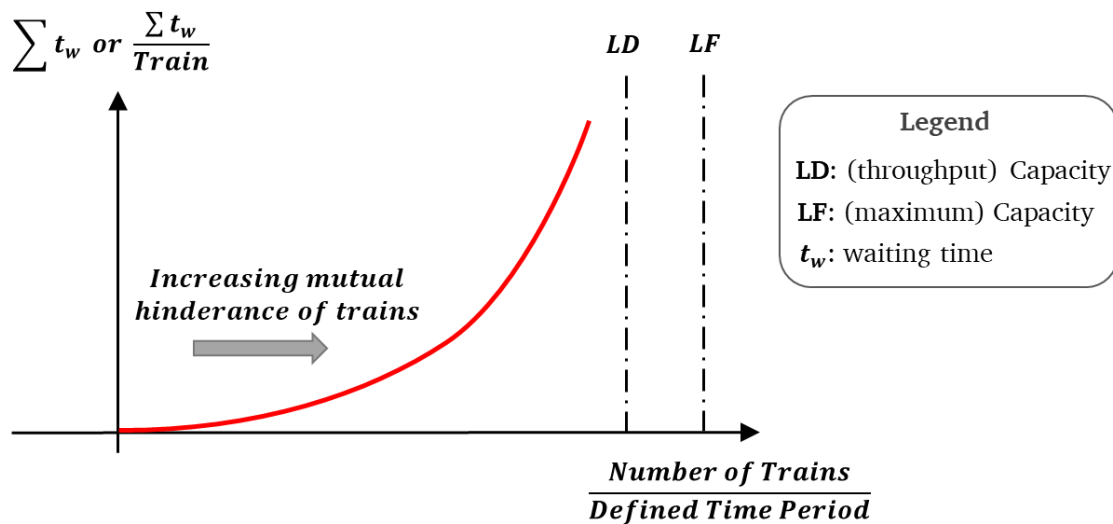

Figure 2.4 Relation between waiting time and capacity (Hansen and Pachl 2014, p.284)

Operations Research provides a wide range of methods that can be utilized to evaluate the railway operations, regardless if the evaluation is performed during planning or real-time operations. Nonetheless, due to the specific characteristic of railway infrastructures, only a few of the available methods are suitable for determining the capacity consumption (Vakhtel 2002). For instance, methods that conduct the evaluation based solely on deterministic principles do not take into account the broad range of variations that take place in railway operations (e.g. variations in journey times or minimum headways) (D’Ariano 2008). To account for the widespread variations

and random influences, stochastic models acquire particular relevance as they allow introducing random distributions in the evaluation (Hansen and Pachl 2014).

Accordingly, to ascertain the capacity consumption of railway infrastructures, there are three methods that are generally utilized. Constructive methods, which are, in large part, founded over deterministic principles; however, if required, they can be retrofitted with stochastic attributes (i.e. delay distributions). Stochastic models can be divided into two general methods, namely, analytical and simulation methods (Vakhtel 2002). Each of these three methods is further discussed throughout the following subtitles.

Constructive Methods

Constructive methods have as main focus the validation of existing schedules; mainly, through the use of the blocking time theory (Meirich 2017). Blocking time theory has mainly been utilized to determine the capacity consumption of the railway infrastructure (Happel 1959). Overall, in constructive methods, the blocking time stairways and train sequences of a given schedule are constructed to determine the capacity consumption and verify if the schedule abides with the quality of service standards needed to be upheld.

The most recognized approach among constructive methods is the so-called “compression” method, which is detailed in the UIC Code-406 – Capacity (UIC 2013). The method allows determining the capacity consumption of a specific portion of the infrastructure (i.e. link section) within a defined time period through the compression of the blocking time stairways. To do so, the method pushes as together as possible the constructed blocking time stairways of all trains within the defined time period, maintaining their sequences and without inducing any occupancy conflicts. The capacity consumption is ascertained by comparing the concatenated occupancy time with the overall defined time period, as generalized in equation 2.12.

$$\rho = \frac{t_z + t_{Ad}}{t_{def}} \tag{2.12}$$

Equation 2.12 allows ascertaining the capacity consumption ρ as the concatenated occupancy time t_z plus some additional time t_{Ad} and divided by the defined time period t_{def} (UIC 2013, p.13).

The method recommends that the defined time period t_{def} must cover a representative portion of the schedule; thus, it should not be shorter than two hours and preferably within the portion of the schedule that covers the peak hours (UIC 2013, p.30). Furthermore, the method introduces additional times t_{Ad} to ensure the quality of the operations. The method recommends different ranges for the additional times, depending on the element under consideration. The values are summarized in table 2.2, which are given as additional time rates, and specific for the infrastructural element being evaluated (UIC 2013, p. 30).

Table 2.2 Recommended additional time rates per infrastructural element in UIC Code-406 (UIC 2013, p.30; modified by Author)

Type of Element		Peak Hour	Daily Period
Link	Dedicated commuter passenger traffic	18%	43%
	Dedicated high-speed link	33%	67%
	Mixed-traffic links	33%	67%
Node	Switching Zone	67% - 25%	
	Platform Track	150% - 100%	

The capacity consumption is then calculated as generalized in equation 2.13, which results in a modified version of equation 2.12 and supports the introduction of additional time rates (in percentage) (UIC 2013, p. 30).

$$\rho = \frac{t_Z * (1 + \text{Additonal Time Rate})}{t_{def}} \quad (2.13)$$

Ultimately, the method also recommends limit values for the ascertained capacity consumption, which are summarized in table 2.3 according to the infrastructural element under consideration. These values are classified according to general schedule characteristics and acceptable quality of service standards (UIC 2013, p. 30-31).

Table 2.3 Recommended limits for the capacity consumption in UIC Code-406 (UIC 2013, p.30-31; modified by Author)

Type of Element		Peak Hour	Daily Period
Link	Dedicated commuter passenger traffic	85%	70%
	Dedicated high-speed link	75%	60%
	Mixed-traffic links	75%	60%
Node	Switching Zone	60% - 80%	
	Platform Track	40% - 50%	

Analytical Methods

Analytical methods support the evaluation of the capacity consumption and waiting times through coefficients of variations of minimum headway times, as well as context-specific admissible values (Hansen and Pachl 2014). Analytical methods do not require a constructed schedule and can perform the evaluation with information of different granularities included in the operating program. It has been equally pointed out in the work of Vakhtel (2002) and D'Ariano (2008) that among available analytical methods, two approaches acquire particular relevance, namely, queuing theory based and probabilistic approaches. Both of these approaches provide suitable means to conduct an effective assessment of the capacity consumption of railway infrastructures.

i) Queuing theory based approaches

Approaches that are advanced within the framework of queuing models are mostly utilized for planning purposes. Queuing theory based approaches permit to ascertain the mean queuing lengths and the waiting times by relating the time between successive arrivals of costumers into a queuing system (i.e. inter-arrival time) and the system's service time.

In the case of railway systems, the inter-arrival time t_A represents the time between requested train paths through a link section of the infrastructure and the service time t_B amounts to the minimum headway time. The variation in these two values can be subjected to different distribution functions to account for their random occurrence, resulting in mean inter-arrival \bar{t}_A and mean service times \bar{t}_B . Both of these values can be represented as rates; where the inter-arrival rate λ is the inverse of \bar{t}_A , analogously, the service rate μ is the inverse of \bar{t}_B . The capacity consumption of a railway infrastructural element (for a single-channel system) is ascertained as generalized in equation 2.14, by dividing the inter-arrival rate λ by the service rate μ (see Potthoff 1969, or Fischer and Hertel 1990).

$$\rho = \frac{\bar{t}_B}{\bar{t}_A} = \frac{\lambda}{\mu} \quad (2.14)$$

Based on the work of Potthoff (1969) and generalized by Fischer and Hertel (1990), the mean waiting time \bar{t}_w is ascertained through the use of a waiting system M/G/1/ ∞ , as detailed in equation 2.15, assuming exponentially distributed interarrival times. In equation 2.15, the mean waiting time \bar{t}_w is computed by taking into consideration the variation in the mean service times within the system. The mean service time \bar{t}_B and its coefficient of variation V_B are ascertained through mean minimum headway times, which can be expressed as a function of the operating program's random train sequence probabilities, also called the "random train mix" (see Hansen and Pacht, 2014).

$$\bar{t}_w = \frac{1}{2} \bar{t}_B * \frac{\rho}{(1 - \rho)} (1 + V_B^2) \quad (2.15)$$

Schwanhäuser (1974) proposes the introduction of train priorities, refining the approximation to compute the coefficient of variation of the service times. Later, Wakob (1985) expanded the approximation made by Schwanhäuser (1974) to account for the variations in the inter-arrival times, thus, working with a waiting system G/G/1/ ∞ . The approach introduced in Wakob (1985) permits to derive the mean scheduled waiting times, which are then utilized as a quality parameter to assess the performance of the railway system.

The derived scheduled waiting times for a respective number of trains can be utilized to determine the performance of the railway system by considering the waiting time function depicted in figure 2.4. As explained in Hansen and Pacht: "[...]as the level of quality – scheduled waiting time in this instance – is infinitely poor in theory. If, conversely, the admissible level for scheduled waiting times is known, a practical capacity can be specified. The admissible waiting time must be derived from the specific transport market conditions." (2014, p.124). For example, the German infrastructure manager in its guideline RIL-405.0104 (DB Netz RIL-405 2009, p.19) provides with a general framework to ascertain the admissible waiting times respective to the German transport market conditions.

Conclusively, the performance of the system is assessed as a result of comparing the computed mean waiting time \bar{t}_w for a respective number of trains against an admissible mean waiting time $\bar{t}_{w,adm}$ derived for a context-specific optimal number of trains.

ii) Probabilistic approaches

Probabilistic approaches concentrate on probabilistic distribution of delays and their propagation throughout the network. Based on statistical information, probabilistic approaches allow an analytical quantification of the railway performance during real-time operations.

Next, three models utilized to compute non-scheduled waiting times are discussed. The first is a general model used to calculate non-scheduled waiting times at junctions and switching zones. The second is a model that focuses on links. The third model focuses nodes, and particularly, platform track elements.

Schwanhäuser (1974) provides an approach to ascertain the probability of an initial delay and non-scheduled waiting times as a function of the distribution of original delays and exponentially distributed buffer times. Relying on the schedule, the probabilistic approach can be employed to ascertain non-scheduled waiting times due to the threading-in of trains in links and specific routes across switching zones.

Carey and Kwieciński (1994) introduce a stochastic approximation method to approach the induced waiting times in single track operations due to variations in minimum headway and journey times. The approach can be used to simplify existing simulation models or the evaluation of capacity consumption of a track (i.e. throughput capacity).

A model focused on the propagation of delays in railway stations has been introduced in Yuan (2006). The stochastic model allows predicting the propagation of delay for the departure of trains from the stations, which are expressed as a function of the delayed arrivals and the dwelling times in platform tracks.

Yet, the approach introduced in Schwanhäußer (1974), is still utilized to determine the performance of the railway system under consideration of the waiting probability or the non-scheduled waiting times as parameters. The waiting probability is understood in the guideline RIL-405.0104 of the German railway infrastructure manager as: “[...] *the percentage of trains that have to wait in front of one or more obstruction points [...]*” (DB Netz RIL-405 2009, p.24 [own translation]).

As with the queuing theory based approaches, both of these parameters must be compared with those that represent an admissible level for the specific transport market conditions. Once again, the guideline DB Netz RIL-405.0104 (DB Netz RIL-405 2009, p.19; 20 and 24) serves as an example, which provides an adept framework to ascertain the admissible non-scheduled waiting times or waiting probabilities respective to the German transport market conditions, supporting the evaluation of the performance.

Simulation

Simulation methods allow evaluating existing schedules and alternative operating programs (Vakhtel 2002). Existing simulation models have also been utilized to validate the feasibility of new operating rules and different approaches for the handling of both disturbed and disrupted situations (Marinov et al. 2013).

Simulation models can be divided into two different categories with respect to the strategy they utilize to perform the simulation of railway operations, namely, synchronous or asynchronous simulations.

Asynchronous simulation approaches are conducted in different steps as trains are systematically inserted in the simulation with respect to their priority. Starting with the trains with the higher priority, trains are inserted, their conflicts are solved; this is conducted systematically until all trains have been simulated (Hansen and Pachl 2014). Random original delays or further disturbances are generated by Monte-Carlo simulation approaches; consequently, trains are appointed with non-scheduled waiting times vis-à-vis their priority in the system (D’Ariano 2008).

Synchronous simulation models are conducted in one single step as trains are no longer inserted with respect to their priority. These models permit a much closer representation of the real operating processes and much easier modelling of random incidences during the operations (Vakhtel 2002). In synchronous models, random original delays are generated throughout multiple simulations, and delay distributions can be appointed at specific locations in the network (D’Ariano 2008).

Simulation methods permit the modelling of the operating sequences or the construction of a schedule. Overall, they provide a broad range of outputs like: secondary delay, capacity

consumption, waiting times due to threatening-in, etc. (Hansen and Pachl 2014, DB RIL-405 2009). The detail with which the outputs are acquired permits to locate them in specific locations within the assessed networks or certain times of day. The performance evaluation is conducted by comparing the ascertained outputs with their predetermined admissible determining variables (as discussed in the previous subtitle).

2.2.5. Summary

Throughout this subsection, the foundations behind the general railway transport management, namely, the planning and monitoring of real-time operations has been discussed. Furthermore, an overview of the different methods, models, and approaches that constitute the railway operations research and support each one of the aforementioned tasks within the management has been presented.

Initially, the groundwork supporting the planning and monitoring of railway operations, from the operating programs to the infrastructure modelling, has been discussed. Within these aspects, different applications and available approaches or models that allow a much more reliable and effective completion of tasks have been reviewed.

Subsequently, the section also provided with different outlooks on the available means to conduct the actual planning or construction of the schedule and the monitoring during real-time operations. The review of available models working within this level has highlighted the complexity of the operations and the dynamic character of the management of trains throughout a railway network. Ultimately, while the approaches and models which have been introduced thus far support the overall management and handling of the railway operations, the discussion must be expanded to move beyond disturbances to include disrupted operations.

2.3. Disruption-Management in Railway Operations

The disturbance-oriented models discussed throughout subsection 2.2.3 focus on the adjustment of either the schedule or circulation plans within specific locations of the network (e.g. an occupancy conflict involving two trains in a switching zone). Conversely, dealing with disruptions requires frameworks that are able to handle much broader spatiotemporal adjustments of the scheduled railway operations. However, the existing literature does not provide with one clear definition regarding what constitutes, or what can be considered a disruption.

One alternative is provided by Jespersen-Groth et al. (2009), which has also been introduced in subsection 2.1. The authors describe disruptions in railway operations as one or a chain of events that interfere with the system's planned operations to such an extent that it renders its scheduled operations unfeasible and must be correspondingly adjusted (Jespersen-Groth et al. 2009). Under such circumstances, the management of the disrupted operations or "disruption-management" requires dealing with at least one of three central problems, namely, schedule adjustment, rolling stock rescheduling and or crew rescheduling (Jespersen-Groth et al. 2009). Furthermore, it is also argued that disruptions do not always render the schedule immediately unfeasible, for example, in cases where crew members are simultaneously incapacitated due to sickness (Jespersen-Groth et al. 2009, p. 402). Consequently, regardless of how swiftly a disruptive event becomes manifest, whether gradually through time (e.g. sick personnel where services need to be systematically cancelled) or swiftly affecting an entire section of the network (e.g. vehicle malfunction), if the

event has a substantial effect on the operations it may be regarded as a disruption (Jespersen-Groth et al. 2009).

A similar understanding as the one provided by Jespersen-Groth et al. (2009) can also be found in the work of Nielsen et al. (2012). The author explains the difference between disruptions and disturbances as: “*In a disrupted situation, the planned resource schedules are no longer feasible and will have to be updated to take the actual situation into account. Disturbances, on the other hand, only need simple recovery measures.*” (Nielsen et al. 2012, p. 496).

Another definition is provided by Corman et al., which describes disruptions as: “[...] *the modification of some infrastructure characteristics, such as the temporary unavailability of one or more block sections, which causes alterations in the train travel times and routes.*” (2010, p. 41). The definition provided by Corman (2010), is primarily focused on the infrastructure and aligned with the understanding utilized in the work of D’Ariano (2008).

Since there is no overarching characterization that allows to clearly identify a disruption of the railway operations, infrastructure managers across the different railway systems also derive their own understandings. For example, the German railway infrastructure manager in its guideline DB Netz RIL-420.9001 defines disruptions as: “[...] *deviations from the planned operations or defined normal conditions.*” (DB Netz RIL-420 2017, p.2 [own translation]). Furthermore, the guideline also provides with a general list of events that have a significant impact on the railway operations and that can be regarded as to engender a disruption in the operations (DB Netz RIL-420 2017):

- Major irregularities on the tracks or on vehicles
- Dangerous events
- Dangerous intervention in the railway operations
- Strikes
- Failure of Traffic Control Management components
- Weather conditions (e.g. heavy snowfall, frost, heavy rainfall, heavy hail storm, floods, etc.)

Although the provided list pinpoints specific events, it ought to be regarded merely as a generalization. Nonetheless, when contrasted with the hazards displayed in figure 1.1, a much general outlook of what constitutes a disruption can be acquired. Such contrast underscores the fact that the railway operations are conducted within a complex and highly interdependent critical infrastructure.

All in all, from the different definitions that have been considered, it is possible to conclude that disruptions are events produced due to different causes and induce substantial changes in the planned operations of a railway network, which ultimately need to be adjusted. The adjustment of the disrupted operations is regarded as disruption-management including its three main tasks, namely, schedule adjustment, rolling stock rescheduling and or crew rescheduling (Jespersen-Groth et al. 2009).

This section discusses and details the disruption-management approaches most utilized to cope with disruptions in the railway operations. Subsection 2.3.1, provides with an overview of the existing alternatives supporting the disruption-management. Subsequently, subsections 2.3.2 and 2.3.3 provide a much more detailed discussion regarding the available alternatives and the existing models. Finally, a discussion and general remarks regarding the existing disruption-management approaches are provided in subsection 2.3.4.

2.3.1. Existing Disruption-Management Approaches

Due to the complexity of the railway network, disruption-management can be regarded as a highly intricate problem, involving multiple stakeholders (i.e. passengers, infrastructure manager, railway operators) (Jespersen-Groth et al. 2009).

The roles, responsibilities, and objectives of each of the stakeholders throughout the disruption-management have been addressed in the existing literature. In the work of Jespersen-Groth et al. (2009) and Schipper and Gerrits (2018), the roles and objectives played by the infrastructure manager and railway operators throughout the handling of the disruption are amply discussed. In De-Los-Santos et al. (2012) and Piner and Condry (2017), the discussion rather focuses on passengers' welfare, their difficulties within disrupted operations, and their interaction with staff members. Finally, an overview of the interplay between all three stakeholders, including the different communication channels throughout disruption-management is discussed in Chu (2014).

Whereas Jespersen-Groth et al. (2009) provide a detailed discussion of the foundations of the three disruption-management problems, and the interaction between different stakeholders, no clear objective outlining the disruption-management processes is provided. Such general objectives are discussed by Oetting and Chu as the authors argue that dealing with disruptions in railway operations involves three overall strategies, which need to be considered holistically (Oetting and Chu 2013, p. 2):

- Identifying and solving conflicts throughout the railway network before they become manifest (involving all three disruption-management problems)
- Mitigating and recovering from existing delays in the system
- Preventing the reproduction of events which lead to delays

In their work, Oetting and Chu (2013) also establish the groundwork through which two different approaches that support the management of disrupted operations can be derived, namely, ad-hoc and planned disruption-management approaches. Such distinction has been further utilized in the work of Schipper and Gerrits (2018), which analyses the present disruption-management approaches and coordination structures of railway systems across five different European countries.

In ad-hoc disruption-management, dispatchers swiftly draft and develop handling measures that better fit the current operating conditions in what would amount to a bottom-up disruption-management approach. Dispatchers address the disrupted operations predominantly based on their experience and partly guided by general dispatching rules and objectives detailed within a valid guideline (Schipper and Gerrits 2018). For example, guideline DB Netz RIL-420 (2017) introduced by the German infrastructure manager (DB Netz), outlines two dispatching objectives for the handling of disrupted operations (DB Netz RIL-420 2013):

- Maximum utilization of capacity across nodes and links
- Fastest possible restoration of the scheduled operations

In planned disruption-management, dispatchers utilize ready-to-use programs that have been pre-emptively established and verified in order to address a specific disrupted scenario (Oetting and Chu, 2013). Commonly referred to as Disruption Programs (DRPs) or contingency plans, these entail a series of tested measures explicitly developed to address the disrupted operations, reducing the dispatchers' reaction time and ensuring a less subjective disruption-management. DRPs include, among other things, a detailed guideline for the operational handling of every affected

line (e.g. services to cancel, turning stations, deviation points), passenger transport replacement strategies and communication protocols (Chu and Oetting 2013).

To date, there is substantial literature, which explicitly engages with disruption-management, and that can be categorized within one of the two overall approaches. The available models address the disruption-management problems to very different extents and utilizing various methods. The following subsections 2.3.2 and 2.3.3 provide a general discussion on the existing structures behind both ad-hoc and planned disruption-management principles as well as the most relevant models developed for both approaches.

2.3.2. Ad-hoc Disruption-Management

Basic Principles

Within ad-hoc disruption-management approaches, dispatchers draft general handling strategies to address specific conflicts and subsequently implement a series of spatiotemporal modifications to the train services which are affected. Throughout the ad-hoc disruption-management process, dispatchers address conflicts across all four fundamental conflict types (see subsection 2.2.3) while simultaneously handle all three disruption-management problems, developing and implementing different dispatching measures as swiftly possible. Overall, the management of the situation is predominantly directed towards fulfilling the system-specific dispatching objectives for disrupted operations, as well as limiting any further modifications of the rolling stock circulation plans and crew schedules (Corman et al. 2011).

Additionally, due to the extensive variation from the planned operations caused by the disruption, dispatchers have fewer constraints to implement a much ample array of measures, when compared to the ones utilized to develop the elemental conflict resolution alternatives in the models discussed in subsection 2.2.3. For example, during a disruption, it is common for a dispatcher to deviate trains along completely different routes across the network to overcome the disrupted section or perform a systematic cancellation or early turn of train services (Corman et al. 2011). Therefore, while in ad-hoc disruption-management, there is ample room for improvisation and the discretionary adjustment of the planned operations, the urgency to restore the planned operation and the overall complexity of the problem makes such efforts a very complex task (Schipper and Gerrits 2018). The complexity of the problem refers to the wide range of decisions that a dispatcher must take within a very reduced time while making sure that these are communicated to the respective members of the staff (e.g. drivers).

The main disadvantage of ad-hoc approaches entails how subjective it is to the capabilities of dispatchers and the system-specific coordination structure. Whereas within an ad-hoc approach, the general disruption-management strategy and the specific measures must be improvised and swiftly developed, these local decisions, which require to be transferred to different actors, not always lead to an improvement of the operations (Schipper and Gerrits 2018). Such circumstances become more challenging to handle if decisions are not being supported by a system, as it becomes problematic for dispatchers to foresee the actual effectiveness and impact of their response on the actual operations. Altogether the aforementioned shortcomings may curtail the quality of the solutions and in due course, the effective management of the disruption.

Current research has focused on the development of real-time decision-support systems aimed at permitting dispatchers to develop much more comprehensive strategies and measures, as well as supporting their ability to coordinate the response between different actors. These models are

discussed in the following subtitles and described for every disruption-management problem individually.

Scheduling Adjustment (Rescheduling)

Models framed within ad-hoc principles adjust the existing schedule by following general dispatching rules or operational constraints (i.e. minimum headways). The schedule adjustment is performed in correspondence to the actual operating situation of the network, including the infrastructure availability (Jespersen-Groth et al. 2009). Ultimately, it must be considered that the schedule adjustment is a very complex problem, known to NP-hard (D'Ariano 2008).

Acuña-Agost (2009) introduced a rescheduling approach that supports the spatiotemporal adjustment of the schedule by means of two different approaches, namely, a mixed-integer linear program and constraint programming. The approach relies on a right-shift rescheduling heuristic to establish an initial solution, which is later enhanced by the exact methods. The right-shift rescheduling heuristic ascertains an initial solution of poor quality by maintaining the original schedule, thus, forbidding unplanned stops, maintaining the allocation of routes and platform tracks, as well as the order of trains in links and nodes. The overall goal is to adjust the schedule by minimizing the difference to the original plan. The approach relies on an objective function that penalizes delays, changes in platform tracks as well as track elements in links, and unplanned stops.

Coreman et al. (2010) introduce a system that is set to enhance the decision-support system proposed in D'Ariano (2008), which has been advanced to address disturbed operations. The system allows managing the interaction between different dispatchers and permits them to exchange and coordinate the development of different conflict resolution alternatives. The introduced system utilizes a microscopic model of the infrastructure and adjusts the schedule through the implementation of both heuristic (based on dispatching rules) and exact methods (the truncated branch bound algorithm introduced in D'Ariano 2008). Later, in Corman et al. (2011), the coordination system is further advanced to allow the introduction of constraints between the coordinated areas, which further enhance the quality of the conflict resolution alternatives proposed to the dispatchers. However, since the system has been designed based on an existing decision-support system targeted at dealing with disturbed operations, its capability to deal with actual disruptions is relatively limited.

Louwerse and Huisman (2014), propose a model utilizing mixed-integer linear programming based on event-activity networks to adjust an existing schedule to fit the disrupted situation. The dispatching measures used to adjust the schedule include: the cancelling of train services, the delaying of a train and the early turning of a train. The model relies on macroscopic infrastructural models and includes some limited aspects of the circulation plan adjustment, as it attempts to balance the existing rolling stock flow in each direction. Finally, its objective function is aimed at minimizing the number of cancelled trains and accumulated delay among all trains in operation.

Veelenturf et al. (2016), building on the model introduced by Louwerse and Huisman (2014), propose a similar rescheduling approach, which also strives to minimize the overall delay and the cancellation of services for the adjustment of the schedule. However, their model is able to consider the transition between the original and the adjusted schedule, while it allows for a wider rerouting of trains across the network. It does this by expanding the adjustment of the circulation plan through the inclusion of an inventory of the rolling stock at the terminal stations (i.e. availability of vehicles at the shunting tracks within the stations).

Ghaemi et al. (2017), present a model employing exact methods to adjust the original schedule and develop a feasible disrupted schedule by relying on an early turning or as is referred to by the authors a "short-turning" of trains, the cancelling and rerouting of trains across the last two technically feasible turning stations before the disrupted section. Expanding on the observations made by Chu and Oetting (2013), the authors highlight the importance of a systematic early turning of trains, which adeptly deals with capacity limitations. Furthermore, the rerouting and rescheduling of the trains are conducted through a mixed-integer linear programming model based on microscopic modelling of the infrastructure. However, it does not explicitly include any adjustment on the affected trains' circulation plan; instead, the implemented objective function seeks to minimize the generated delay and the number of cancelled services.

An early version of the above-discussed model was presented by Ghaemi et al. (2016), which has been later extended in Ghaemi et al. (2018a). In this version, a macroscopic infrastructure modelling is utilized, which computes the arrivals and departures of trains along their routes and maintains a fixed train order. The schedule adjustment is still conducted by a mixed-integer linear programming model and an objective function that penalizes the delay and cancellation of services. However, by keeping a macroscopic scope, the authors claim that they can project the disruption length, evaluate the passenger delays, and consider the flow of trains on both sides of the disruption.

Ghaemi et al. (2018b) propose an approach that deals with three different tasks within the schedule adjustment, namely, estimating the disruption length, adjusting the schedule in respect to the estimated disruption length and measuring the passenger delay generated by the adjusted schedule. The approach is constituted by three different models, each addressing one of the tasks and assembled in series in the order in which they have been listed. Initially, the disruption length is projected through the probabilistic distribution length model proposed in Zilko et al. (2016), which utilizes Bayesian copula networks to model the disruption length. The schedule adjustment is performed through the model proposed by Ghaemi et al. (2016). Finally, the induced passenger delays are ascertained through a newly proposed multinomial logit choice model that permits to approach the passengers' chosen routes and the share of passengers through the selected routes. With this information, the passenger delay induced by the adjusted schedule can be estimated.

Rolling Stock Rescheduling

The rolling stock rescheduling entails the adjustment of the circulation plans of vehicle and vehicle compositions, as was the case during the handling of disturbances. However, in the specific case of disrupted operations, the rescheduling or scheduling of new shunting movements, as well as dealing with end-of-day imbalances, plays a much more relevant role (Jespersen-Groth et al. 2009). Furthermore, it must be noted that available models are advanced along with the assumption that the schedule has already been adjusted, constituting an input for the adjustment of the circulation plans (Nielsen 2011, Jespersen-Groth et al. 2009).

Nielsen (2011) retrofitted the short-term rolling stock rescheduling model introduced in Fioule et al. (2006) and made it capable of dealing with disrupted operations. The authors considered that the adjusted schedule as input and introduced a more comprehensive set of different parameters into the structure presented by Fioule et al. (2006). The enhanced model not only supports the coupling and decoupling of vehicles and vehicle compositions but also supports the cancellation of train services, as foreseen by the adjusted schedule. Furthermore, the model also supports performing end-of-day inventories at end stations to ascertain the induced end-of-day imbalances product of the modification of the circulation plans. The model is formulated as an integer linear

programming problem with an objective function that seeks to limit changes in the originally planned circulations between vehicles, the shortage of seats in the scheduled train services and the need to reschedule shunting operations due to end-of-day imbalances. The model has been further modified in Nielsen et al. (2012), where the authors introduce a rolling horizon approach to deal with uncertainties such as the schedule adjustment and the disruption length. The authors also consider the adjusted schedule as an input, which is revised as time progresses and rolling stock decisions are only executed if they are within a certain time horizon.

Kroon et al. (2015) extended the model introduced in Nielsen et al. (2012) to include passenger demand. The approach relies as input on the adjusted schedule and circulation plans ascertained as in Nielsen et al. (2012) and models passenger flows to modify the circulation plans once again. Passenger flows are modelled off-line, distinguishing between passenger groups through an event graph network and a situational heuristic algorithm. The modelled passenger flows are inserted in the existing model to optimize the circulation plan once again, which ultimately results in a two-stage feedback loop.

Lusby et al. (2017) propose a model to adjust the circulation plan of vehicles and vehicle compositions utilizing a branch and price algorithm solved through an integer linear program. The model allows adjusting the circulation plans of vehicles between train services while taking into consideration the coupling and decoupling of vehicles as well as maintenance restrictions. The model penalizes the induced end-of-day imbalances and does not engage with the rescheduling of shunting operations.

Wagenaar et al. (2017) extended the model introduced in Nielsen (2011) to account for passenger demand and the utilization of dead-headed trips. In their approach, the authors propose a mixed-integer linear program and modelling of passengers' flows to approach the adjusted demand during the disruption. The objective function utilized to solve the linear program seeks to limit changes in the originally planned circulation between vehicles, the seat shortage in the scheduled train services, the need to reschedule shunting operations utilizing the end-of-day imbalance inventory, the number of dead-heading trips in the schedule and the total passenger delay.

Crew Rescheduling

The crew rescheduling entails the adjustment of the crew members' schedule so that every train service can be allocated the required personnel. For this task, it is necessary to count with the already adjusted schedule and circulation plans to acknowledge the specific number of drivers and onboard staff to be assigned to each rescheduled train service (Jespersen-Groth et al. 2009).

Potthoff et al. (2010) address the crew rescheduling as a set partitioning problem with side constraints and where different train services may be covered by more than one crew duty (the model supports only drivers). Initially, a starting core problem is derived, in which all unfeasible and candidate crew duties are solved. It is possible that some train services can not be appointed with a crew duty; in this case, a new core problem is derived. The new core problem constitutes a neighbourhood of other crew duties that may cover the conflicting train service. The core problems are explored utilizing a column generation heuristic, which has feasible solutions derived using a greedy algorithm.

Veelenturf et al. (2012) expanded the model proposed by Potthoff et al. (2010) to support the capability of delaying the departure of some train services. The user can adjust the amount of delay

introduced to the train services, allowing the existing approach to adjust the crew schedules with much more flexibility, thus, find much more reasonable solutions.

Models Addressing Multiple Disruption-Management Problems

While the main objective of the models discussed thus far has been the specific handling of one of the three disruption-management problems, models that address more than one of the three disruption-management problems simultaneously are fairly available.

Fekete et al. (2011) introduced an approach to deal with both the adjustment of the schedule and circulation plans of vehicles and vehicle compositions. The model is generalized to be implemented across any kind of rail-based transportation, including subway and light rail networks. The railway network is modelled through an event-activity network, which supports the simultaneous adjustment of the schedule and circulation plans. The model is solved through an integer linear program with an objective function that seeks to maximize the number of train services and minimize the delay, the early turning of trains and the removal of trains out of the system.

Cadarso et al. (2013) introduce a two-step model that supports the schedule and circulation plan adjustment, while it also includes an approach to account for passengers' behaviour. Initially, the schedule and circulation plans are adjusted through a mixed-integer linear program, which is advanced to perform the adjustment within a given planning period that takes into account the disruption length and a recovery phase. Later, utilizing a multinomial logit model to model the passengers' behaviour, the demand of the adjusted schedule and circulation plans can be ascertained. Ultimately, the utilized objective function seeks to minimize the operating cost per kilometre, the operating costs of empty movements, alterations of vehicle compositions, train service cancellations, insufficient seating availability and the utilization of different vehicle compositions for specific train services.

Dollevoet et al. (2017) introduce an iterative rescheduling framework, which permits to deal with all three disruption-management problems. The model merges three existing rescheduling models, which are organized in an iterative modular structure. At the outset, the adjustment of the schedule is conducted through the approach introduced in Veelenturf et al. (2016). Subsequently, the model proposed in Nielsen et al. (2012) is incorporated to perform the rescheduling of the rolling stock and, ultimately, the model detailed in Veelenturf et al. (2012) is in charge of crew rescheduling. In the proposed iterative framework, the models supporting the adjustment of the schedule and circulation plans are first executed in series (i.e. first the schedule adjustment), where there is a feedback loop between these two tasks. Finally, the crew rescheduling is executed, and a feedback loop with the previous two models is also considered.

Discussion

Throughout this subsection, a series of different models that allow addressing one or more of the disruption-managements problems have been discussed. The discussed models are based on ad-hoc principles as they generate a solution from the bottom-up without incorporating information contained from DRP, regardless of their availability.

Most of the discussed models address one definite disruption-management problem through optimization approaches and incorporating exact methods (e.g. linear programming). Just as with CDCR processes based on optimization approaches (see subsection 2.2.3), while existing models are able to uphold the quality of their solutions, they are forced to make certain generalizations. Within disrupted operations, the best example of such generalization might be the need to either

leave aside the adjustment of the different vehicle's circulation plan together with the adjustment of the schedule as in Ghaemi et al. (2017) or by considering the adjustment of the circulation plan as inherently dependent of the adjustment of the schedule as in Nielsen et al. (2012) or Dollevoet et al. (2017).

As a result, a very limited amount implement heuristics approaches despite the complexity of the problems or provide an overarching framework to systematically address more multiple problems at the same time. Dollevoet et al. (2017) point out that despite an explicit recognition of researchers and practitioners of the need to put forward overarching approaches, there remains a lack of methods that effectively and systematically address all disruption-management problems or even try to align existing models for this purpose.

2.3.3. Planned Disruption-Management – Disruption Programs (DRPs)

Basic Principles

Overall, DRPs are pre-defined programs that contain a series of dispatching decisions, simplifying the work of dispatchers during the disruption-management (Brauner 2019). Like any other P&P strategy (see subsection 1.2), DRPs provide with the necessary means to uphold the continuous service of the system, allowing it to adapt to a degraded situation while upholding as many of its capabilities as possible.

Altogether, DRPs can be implemented in different contexts (e.g. long-distance railway operations, medium or regional railway operations, etc.) and are increasingly being recognized as the foundation of robust railway services (Christoforou et al. 2016). For example, in the case of commuter railway networks, DRPs constitute prominent tools as they allow for safeguarding the welfare of an ample number of users from disruptions in their operations. Their proficiency is such that operators throughout many different European railway systems (i.e. Switzerland, Germany, and the Netherlands) have started benefiting from their development (Nielsen et al. 2012, Chu and Oetting, 2013).

DRP's mainly function as dampers on the rapidly escalating operational consequences (“knock-on effects”) unchained by disruptions and their impact on the system's operating capabilities and passengers' welfare (Christoforou et al. 2016). They provide with a clear outline with a line-specific granularity of the operational as well as passenger transport-related measures that need to be implemented for an effective and prompt response to the occurred event. Furthermore, DRPs also provide with a road map supporting the communication between all the stakeholders, thus, facilitating the understanding and the flow of information (Chu et al. 2012). Ultimately, as a repository of already tested strategies, DRPs reduce the amount of ad-hoc dispatching decisions that need to be developed, decreasing the workload of dispatchers and simplifying the exploration of context-specific measures.

The line-specific measures that constitute the DRPs are developed for a standard disrupted scenario and address, on the one hand, the disrupted railway operations, and on the other hand, the affected passenger transport capabilities of the system (Chu et al. 2012). The subset of measures outlining the overall strategy that deals with disrupted operations is regarded as the: “DRP Operating Concept”. DRP operating concepts contain operational measures (e.g. early turning, deviating) for every line in the railway network that allows dispatchers to address the reduced infrastructure availability, mainly by reducing the capacity consumption around the disrupted area (Brauner and Oetting 2019). The subset of measures that outline the strategy to deal with the

reduce serviceability of the system is regarded as the “DRP Transport Concept”. DRP transport concepts consist of passenger transport compensation measures (i.e. rerouting passengers to other transport means) explicitly designed to uphold the passengers’ travel chains either through the railway network or relying on external systems (e.g. public transport systems) (Brauner and Oetting 2019).

Furthermore, the implementation of a planned disruption-management approach has been adeptly described by Chu et al. (2012) as a sequential process summarized in five phases. The five phases are displayed in figure 2.5.

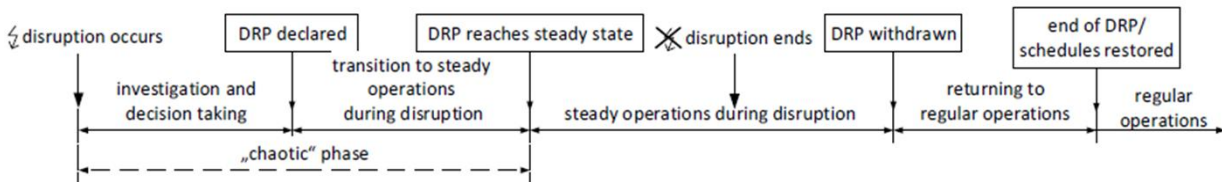

Figure 2.5 Phases of the planned Disruption-management approach (Chu and Fornau 2011, as cited in Chu and Oetting 2013)

The implementation of DRPs starts with the occurrence of a disruption. Immediately, an investigation and decision-making phase comes into effect, where the dispatchers and the personnel investigate the situation and evaluate the measures which need to be implemented (Oetting and Chu 2013). The investigation phase results in the declaration of the DRP that better resembles the actual operating situation from the set of DRPs that are available for the specific railway network. Once the DRP is declared, the actual operating situation of the network must be manually transitioned to match the operations foresaw in the DRP operating concept, ultimately reaching stability within the degraded condition. A DRP is said to have reached stability once all trains find themselves on their line-specific pre-defined routes, and the pre-defined number of trains circulates in the system reliably without accumulating delay (i.e. with the punctuality of regular operations) (Oetting and Chu 2013, Brauner 2019). The period between the disruption has taken place until the DRP has reached stability is regarded as the “chaotic” phase. The period is regarded as being chaotic since uncertain and contradictory information is still being exchanged by the different stakeholders (Chu 2014). Finally, after the cause of the disruption has been overcome, the DRP is withdrawn, and the system can return to its originally planned operations.

To secure an effective and efficient disruption-management, the transition to stable operations is of particular importance (see figure 2.5). In due course, the earlier the DRP is able to reach stability, the better the operational quality of the DRP as a whole (Oetting and Chu 2013).

Oetting and Chu (2013) provide with a thorough description of what influences the transitional phase within the context of commuter railway networks and, ultimately, provide with a series of recommendations for improving the transition to stable operations. The recognized influences on the transition phase can be summarized in three categories, namely, external factors (e.g. location of the disruption), internal factors (e.g. coordination structure) and resources (e.g. availability of additional vehicles, available infrastructure for turning and parking trains) (Oetting and Chu 2013, p.4-5). To deal with the shortcomings, the authors provide four punctual recommendations for improving the transition to stable operations (Oetting and Chu 2013, p.15-17):

1. *Choice of turning stations:* at the early moments of the disruption, there might be a large number of trains queuing in the area near the disruption (i.e. critical area). At the beginning of the transition phase and in order to dissolve the queue, trains must be

systematically turned throughout different stations (regardless if they have reached the stations appointed by their DRPs) where a change in direction is technically feasible (i.e. turning station). By dissolving the queue, the delay in the system can be reduced, and the network's transition to stability may be achieved in a much reduced time. Such aspects also become relevant during the development of the DRPs, where the appointment of turning stations for every line can be verified so as to ensure that queuing does not become predominant within the designed DRP. Such verification must ensure that the arrival rate of trains to the turning station (particularly turning stations in the critical area) is less than the average service time at the station (i.e. time required to turn the trains at the given station).

2. *Limiting delay propagation in turning stations:* during the transition to stability, it is difficult to first select a turning station for queuing trains, and second, select the best possible train service to be appointed after a train has been turned at the selected station. The train service that is appointed to the train after its turn at the selected turning station would determine if the train is delayed or not, and potentially, the magnitude of the delay with which the train would start its service. Therefore, an effective way to prevent delay propagation can be achieved by providing with structured starting times for trains at the DRP turning stations. However, since trains from different lines may turn at the same turning station, the starting times must be allocated at separated platform tracks in a line-specific manner.
3. *Improving operating procedures during the transition phase:* since DRP must be deployed manually to the actual operating situation, dispatchers must still take some ad-hoc decisions (e.g. choose appropriate turning stations to dissolve the train queue). Therefore, decision guidelines and protocols that support dispatchers selecting appropriate dispatching measures would be utterly beneficial to guarantee a much uniformed transition of the network to stable operations.
4. *Communication processes during the disruption:* while existing communication structures and guidelines are already developing together with DRPs, these can be extended to support the coordination capabilities between staff members during the transitional phase. If the solution for the specific problems can be agreed and communicated effectively and efficiently amongst all the relevant personnel, train queues near the disrupted section can be dissolved much faster and less additional dispatching tasks are necessary.

Due to their inherent nature as P&P strategy, planned disruption-management approaches can be divided into a planning or development phase and a deployment phase (see subsection 1.2). Each of these phases is also projected into both the DRP operating and transport concepts, as depicted in figure 2.6.

	Operating Concept	Transport Concept
Development Phase	Evaluation of DRPs based on the transitional phase	Validation of DRPs based on their transport concept
Deployment Phase	Deployment of the DRP on the actual operating situation	Deployment of the transport concept on the actual passenger-flow and behaviour
	Deployment of the DRP on the actual infrastructure availability	Deployment of the transport concept on the actual availability of alternatives

Figure 2.6 Phases within planned disruption-management (by author)

Within each of the phases detailed in figure 2.6, relevant tasks have been positively derived (see also Brauner and Oetting 2019).

The following subtitles provide a detailed description of the tasks within the development and deployment phases and an overview of available tools and approaches to fulfill the detailed tasks.

Development of DRPs

The development of DRPs has been generalized as a sequential process. First, the operating concepts are developed, and later, the transport concepts are tailored to the specific needs of the operating concept (Chu et al. 2012).

Chu et al. (2012) provide a methodological framework supporting the manual development of the operating and transport concepts utilizing operational measures like the ones detailed in table 2.4. The measures detailed in table 2.4 allow addressing a complete or partial blockage (i.e. single track operations) of the infrastructure. The methodological framework has been established through an extensive gathering of dispatchers' collective knowledge and experience, and is now utilized as guideline for the manual development of DRPs throughout a broad range of German railway networks. In overall, the methodological framework addresses the actual developmental aspects (see figure 2.6) of both transport and operating concepts and foresees the utilization of workshops and professional supervision to generate as well as evaluate the feasibility of DRPs.

The framework proposed in Chu et al. (2012) is complemented by Chu (2014) with an approach that allows a much detailed evaluation of the DRP operating concepts. The evaluation of the operating concepts concentrates on ascertaining the capacity consumption at turning stations during the transition phase. In the approach, the capacity consumption is ascertained through constructive methods, implementing principles from the UIC Code-406 (UIC 2013) and introducing stochastic parameters to approach the actual blocking time of trains at platform tracks during a disruption. The stochastic parameters have been established through a detailed statistical analysis of the actual blocking time of the platform tracks at turning stations during disruptions of commuter railway lines in two different cities. The analysis distinguished between turns conducted with one and with two drivers and established specific temporal supplements that can be added to minimum turning times. The resulting time supplements for trains are as follows (Chu 2014, p.103):

- To cover for 90% of the studied cases, the supplement value to the minimum turning time should be 3 minutes regardless of the number of drivers available on the train (up to 2).
- To cover 95% of the studied cases, the supplement value to the minimum turning time should be 6 minutes regardless of the number of drivers available on the train (up to 2).

Table 2.4 List of all elemental dispatching measures available for the development of DRPs (Chu et al. 2012, Chu and Oetting 2013, Oetting and Chu 2012, and Brauner 2019)

Category		Measure
Operational (Train run Related)	Bypass	Deviation: the route of a specific train service or all train services of a given line are deviated through a completely different route.
		Reroute: the route of a specific train service or all train services of a given line through specific nodes are modified (lines normally utilized in the opposite direction may also be used).
	Reduction of Traffic	Total cancellation: all train services of a given line are cancelled.
		Partial cancellation: the lines are appointed with one DRP turning station; this entails that only one section of the line and one of the original end stations are served.
		Partial cancellation with replacement: the line is appointed with two DRP turning stations, one on each side of the disruption; this entails that the portion of the line between the two DRP turning stations is not served.
		Deviation with replacement: the route of a specific train service or the entire line are deviated through a completely different route; furthermore, a DRP turning station is appointed outside of the original route. The section between the deviation point and one of the two original end stations of the line is not served.
	Increase of Traffic	Cancellation of stops: certain stopping locations (including platform tracks) of a specific train service or all train services of a given line are cancelled
		Additional stops: additional stopping locations of a specific train service or all train services of a given line are appointed
	Reduction/ Increase of Traffic	Modification of vehicle compositions: vehicle compositions appointed to two different train services can be coupled or decoupled
		Modification of the service interval of a line: specific train services of a given line are cancelled, or new services are introduced
Transport (Passenger Related)	Intermodal Rerouting	To different railway services (regional, long-distance)
		To different means of public transport (Bus, Subway, Trams, etc.)
		Alternative replacement services (emergency bus services, taxis)

Brauner (2019) establishes an evaluation algorithm with general validity intended for supporting a semi-automated assessment of DRP operating concepts for commuter railway networks. Conceived as a modular structure with adjustable evaluating restrictions and standards, the evaluation algorithm is based on the work of Chu et al. (2012) and Chu (2014). The proposed modular structure foresees an iterative verification of the DRP operation concept by first verifying its functionality, and later, its feasibility. The functionality of the operating concept is verified within the stable phase by examining the following features (Brauner 2019, p.23):

- The technical, operational and traffic-oriented feasibility of measures appointed to a given train or line (see table 2.4) and determined via hard and soft exclusion criteria
- The functionality of a measure throughout each one of its application locations in the network during the stable operations (e.g. capacity consumption of platform tracks in turning stations)

-
- The variation in blocking times across different parts of the route, this is particularly the case, when disruptions result in a partial blockage of a section (i.e. single-track operation)

Once the algorithm verified the functionality of the operating concept, its operational feasibility is verified. The operational feasibility is verified by corroborating that the operating concept is, first, able to transition the system to stable operations, and second, the duration until stability is finally reached. The transition phase is verified following a similar approach as the one in Chu (2014), utilizing constructive methods supported by stochastic parameters. However, in this case, the approach focuses on two critical components, namely, the time until the pre-defined number of trains circulating in the network is reached and the time required to reduce the delay of trains queuing near the disrupted section. The approach introduced in Brauner (2019), ultimately sets the groundwork for the (partial) automation of DRPs' development.

Brauner and Oetting (2019) extend the evaluation algorithm introduced in Brauner (2019) to include the transport concept in the validation of the DRP. The algorithm includes a feedback loop where the transport concept is first developed on the basis of the operating concept. Later, the whole DRP is validated based on the quality of service that is offered to the passengers as a combination of both concepts. The transport concept is developed utilizing a heuristic CDCR approach as the ones discussed in subsection 2.2.3. Initially, the broken passenger travel chains are identified (based on the operating concept), as conflicts, and different resolution alternatives are explored by utilizing transport measures similar to the ones detailed in table 2.4. The exploration of solutions is conducted by detecting generally viable travel connections corridors inside (e.g. other railway passenger services) and outside of the railway network (e.g. local public transport means), which are analyzed to identify potential bottlenecks. Ultimately, the service quality of the resolution alternatives (across all potential corridors) is evaluated and subsequently selected to establish the transport concept. The alternatives are evaluated by considering passenger delays at stations and trains, and additionally required transfers. However, in the proposed evaluation structure, the capacity limitations of existing public transport alternatives utilized to support the broken travel chains of disrupted railway passengers are not taken into consideration.

Deployment of DRP

The deployment of a specific DRP has been described and summarized as the chaotic phase, which is comprised of two specific phases, namely, the investigation and transition to stable operations (Chu et al. 2012, see figure 2.5).

During the investigation phase, dispatchers gather the necessary information regarding the disruption (e.g. affected infrastructure, affected vehicles) and choose one specific DRP from the set of DRPs available for the network. The investigation phase not only entails choosing the DRP but also setting-up the operating concept of the selected DRP within the actual operating situation of the network. The DRP set-up includes the identification of the infrastructural elements in the network utilized by the line-specific measures of the chosen DRP (e.g. turning stations, deviation points, etc.), and establishing the dispatching success of every single train in the network vis-à-vis the identified infrastructural elements (Oetting and Chu 2013). The dispatching success makes direct reference to the handling possibilities and the delay that a train may acquire during the deployment of the DRP operating concept, considering its actual location in the network (Oetting and Chu 2013).

Furthermore, while DRP operating programs provide with tested line-specific measures, dispatchers still need to appoint ad-hoc measures to the specific trains while taking care that the

network is able to reach stable operations in the shortest time possible (Chu 2014). The transition to stable operations entails the implementation of dispatching measures to specific trains so that the line-specific and pre-defined number of trains can be reached, and simultaneously, trains can be directed to their line-specific and pre-defined routes (Oetting and Chu 2013).

Choosing the DRPs

The choosing of a specific DRP requires that dispatchers compare the type of disruption as well as its extent (i.e. affected infrastructural elements) with the different scenarios contained in the set of DRPs available for the network. Dispatchers manually choose the DRP, which better fits the actual disrupted operations. The choosing process of a DRP has been studied in the work of Oetting and Chu (2013) and Chu (2014). However, to date, there is no decision-support system or model available to support choosing the DRP during real-time operations.

In Chu (2014), while conducting the analysis of additional blocking times during disruptions, specific tasks that must be fulfilled by the dispatchers during the investigation phase (see figure 2.5) have been systematically documented. Two tasks with particular relevance have been identified. The first task consists of choosing the best suited DRP, considering the deploying context (e.g. carnivals, ongoing sports events, etc.) and establishing the actual infrastructure availability (i.e. ongoing maintenance, construction or renovation works). The second task entails the need to adjust the line-specific measures contained in the DRP operating and transport concepts in order to match the actual deploying context and infrastructure availability.

Adjusting the operating and transport concepts to the deploying context and infrastructure availability involves introducing local, or global adjustment, to both the DRP operating and transport concepts. Reasons for the need of local adjustments of the operating concept are, for example, switches or platform tracks in DRP turning stations that are not available due to construction or maintenance works. On the other hand, global adjustments involve more complex modifications to the concepts (e.g. unreachable DRP turning stations or inaccessible deviation points). Ideally, a comprehensive adjustment of the DRPs would entail having their functionality and feasibility verified in real-time, as discussed in Brauner (2019). However, to this point in time, the necessary adjustments of the DRP concepts must be either developed, verified and introduced ad-hoc by dispatchers, or as last alternative, a DRP from the set of DRPs available for the network that considers a wider disrupted area is utilized.

Set-Up of the Chosen DRP

Once the DRP has been chosen, its line-specific operating concept must be set-up. Setting-up the chosen DRP operating concept supports the subsequent deployment of its line-specific measures throughout all the trains circulating in the network.

The set-up process derives from the analysis conducted by Oetting and Chu (2013) regarding the implementation of DRPs across two commuter railway networks in Germany. The analysis identified different reasons, and the specific network location in which delays occurred after declaring a DRP. The most relevant reasons have been explained as to be the queuing of trains in the critical area, and the use of deviations. Moreover, the specific locations in the network where delays have been mostly generated are identified in stations utilized for the turning of trains, inherently, including DRP turning stations and end stations. The findings derived the need to categorize each of the trains in the system so that the dispatching success (i.e. the possibility to salvage them or not – see Oetting and Chu 2013, p.12) can be apparent to dispatchers.

The authors explain that: “In order to measure the dispatching success during the transition phase, the analysis focuses on different groups of trains which are defined by their location in the network at the time of DRP declaration. [...] The categorization by location at the time of DRP declaration provides information about the prospects of each train being delayed by the disruption or not.” (2013, p.12-13). Overall, the authors foresee the clustering of the trains in three general categories, namely, Red Yellow and Green trains (Oetting and Chu 2013). Trains are clustered in each of the three categories by contrasting their actual location in the network the moment the DRP is being deployed in correspondence with the DRP relevant infrastructural elements.

Trains are introduced in one of the three clusters as follows (Oetting and Chu 2013, p.12-13):

- If at the moment of the DRP deployment, the train drives towards its end station (i.e. away of the disrupted section) or has not yet reached its the DRP turning station or deviation point appointed to its line, it can be clustered in the Green category.
- If at the moment of the DRP deployment, the train drives towards the disrupted section and has already passed the DRP turning station or deviation point appointed to its line, it can be clustered in the Yellow category.
- If at the moment of the DRP deployment, the train finds itself beyond the last turning station with the technical feasibility to support changing the driving direction before the disrupted section, it can be clustered in the Red category. Trains, which have been directly affected by the disruption are also introduced within this cluster. However, in Chu (2014), it is argued that not all the Red trains have an equal handling capability since some trains just require a time-out before they can resume their drive during the disruption.

Deployment of DRPs

The deployment of DRPs during real-time operations must be framed within the three disruption-management problems. As with ad-hoc approaches, dispatchers must address the disruption considering the adjustment of the schedule, rolling stock rescheduling and crew rescheduling. Current DRP implementing practices demand dispatchers to manually fit the DRP operating concept to the existing situation; thus, all three problems within disruption-management are still manually handled.

Overall, despite the existence of DRPs, dispatchers still develop and implement ad-hoc dispatching measures. On the one hand, the measures included in the DRP operating and transport concepts eases dispatchers’ decision-making processes by removing uncertainties and allowing them to dedicate more time to develop measures for each individual train with higher quality (Schipper and Gerrits 2018). Nonetheless, the utilization of a planned disruption-management requires dispatchers to guarantee that the network transitions to stable operation as fast as possible, throughout the development and implementation of every dispatching measure (Oetting and Chu 2013). For example, dispatchers ought to take care that the faster the train queues in the critical area are dissolved, the faster the system becomes stable. Consequently, within current implementing practices, the successful implementation of a planned disruption-management is still influenced by subjective factors such as the experience and skill of highly strained dispatchers.

Very limited literature exists, featuring DRPs as part of decision-support models, particularly, with the ability to support its deployment to the actual operation. Nakamura et al. (2011) introduced a heuristic algorithm for schedule adjustment utilizing existing DRPs or as the authors refer to them “*train-rescheduling patterns*”. The approach utilizes the DRP operating concepts to build

constructively an initial rescheduled plan. This plan is further adjusted through heuristic algorithms, utilizing context-specific dispatching methods, to ultimately adjust the schedule. The process observes certain circulation planning matters and tries balancing the vehicle flow in a similar way as Louwse and Huisman (2014). To evaluate the adjusted schedule, the authors structure an index strictly tailored from a passenger perspective, focusing on weighting the changes in travel time, number of transfers and resulting occupancy within the vehicles. Ultimately, the authors argue that by merging the DRPs' information with practical knowledge, their approach can maintain a simple structure, gain further relevance for its actual usage and improve passenger satisfaction.

Discussion - Obstacles in the Deployment of DRP

At the outset, whereas DRPs provide with a line-specific outline to address the disrupted operations, their manual deployment of on the actual operating situation highly restricts the proficiency of the disruption-management. Therefore, it is possible to conclude that the current deployment practices (i.e. manual) constitute the central obstacle for the deployment of DRPs. Nonetheless, researchers point out different features of the DRPs to explain their disadvantages.

Ghaemi et al. (2017) pinpoint the specific disadvantages of utilizing DRPs for rescheduling purposes. The authors initially argue that DRPs are designed manually, and the quality of their operating concepts is not optimal. However, these matters have been recently addressed by the work of Brauner (2019) and Brauner and Oetting (2019). Furthermore, the authors also argue that DRPs are static, as they need to be updated to fit any schedule or infrastructure modification and can not observe all possible disruption scenarios. These remarks highlight the lack of a framework that supports the adjustment of DRPs to the actual deploying context and infrastructure availability, as discussed in previous subtitles. Finally, the authors also discuss that the lack of a framework that supports dispatchers dealing with the transition phase also stands as a significant obstacle for the use of DRPs.

Schipper and Gerrits (2018) argue that in practical terms, DRPs induce a rigid and inflexible disruption-management as they curtail the flexibility with which dispatchers are able to respond to disruptions. While such remarks are accurate in first instance, the authors fail to consider DRPs within the understanding of P&P tools introduced in subsection 1.2. P&P strategies are detailed as the means to uphold the service qualities of a system since the early moments of the disruption, as it has been directly acknowledged in Brauner and Oetting (2019). Nonetheless, without ensuring the capability of DRP to reach stable operations, the general implementation of planned disruption-management approaches is still questionable.

2.3.4. Summary

Overall, the literature review regarding disruption-management approaches has provided an overview of the methods and models which are currently available and utilized across both ad-hoc and planned approaches. Furthermore, it has allowed to point out a remaining lack of methods that support a generalized handling of the disruption-management problems across both planned and ad-hoc disruption-management approaches. Ultimately, the most noticeable distinction between the two approaches observes the overall share of models available for ad-hoc vis-à-vis planned disruption-management, the main share of the models is grounded on ad-hoc principles, leaving very limited literature available and directly applicable for planned disruption-management.

Within the ad-hoc disruption-management approach, the majority of the available models focus on one of the disruption-management problems through the utilization of exact methods. Whereas models that align different methods exist (e.g. Dollevoet et al. 2017), a comprehensive coordination and interchange framework supporting the management of multiple problems and that also includes passengers' welfare is not currently available.

The effectiveness and efficiency with which planned disruption-management approaches deal with disrupted operations are said to be dependent on: the quality and detail behind the development and deployment of both the operating and transport concepts (Chu et al. 2012).

On the one hand, the sound development of DRP from both operational and passenger transport perspectives has been addressed in the work of Chu et al. (2012), Chu (2014), and the practical approaches provided by Brauner (2019) as well as Brauner and Oetting (2019). The development of DRP transport concepts, as a function of the operating concepts, can be effectively conducted through the approach introduced in Brauner and Oetting (2019). However, the development of passenger transport compensation strategies within the DRP transport concepts and their evaluation still requires further exploration. Particularly, considering the capacity limitation of existing public transport alternatives utilized to support the broken travel chains of disrupted railway passengers.

On the other hand, the literature review regarding the deployment of planned disruption-management approaches has allowed recognizing the limited line of inquiry regarding their inclusion within existing decision-support mechanisms. Furthermore, the limitations explained by Ghaemi et al. (2017) and Schipper and Gerrits (2018) can be traced to the current DRP deployment practices (manual deployment) and the lack of approaches that support or even automatize the deployment of both the DRP operating and transport concepts on the actual situation. All in all, the deployment of planned disruption-management approaches and the processes that are to be supported within this phase (e.g. adjustment of the DRPs, minimizing the transition times to stability) have not been adequately investigated to date.

2.4. Passenger Transport Compensation During Disruptions – Transport Concept

2.4.1. Introduction

Disruptions in railway systems inevitably impact upon their users. Disturbed passengers strive to find plausible alternatives to deal with the disrupted situation, which can be helped or hindered by the deliberate or sometimes unintentional actions of rail transport operators. What is more, as patronage continues to grow consistently (Newman and Kenworthy 2015), and due to increasingly tight coupling with other systems (Rinaldi et al. 2001), securing proficient transport compensation structures becomes critical. Reliant on uninterrupted railway transport structures, the welfare of disrupted passengers must be upheld even during the occurrence of extreme operating events, either through the provision of replacement transport services or by taking advantage of existing alternative local transport structures.

The management of disrupted passengers travel chains during railway disruptions entails addressing the broad array of possible scenarios presented by any disrupted situation. Coping with such eclectic conditions implies mediating between the affected railway operations, their disturbed passenger transport capacity and the length of the disrupted situation (Ghaemi et al. 2018b).

However, despite the relevance of pursuing passenger rerouting strategies, the operational features and their stability remain the dominant parameters for final decision-making (Pender et al. 2013).

The authors Pender et al. (2013) performed a thorough analysis of passenger transport compensation schemes across railway management organizations in different countries. They conclude that the success of these courses of action is mainly contingent on the availability of parallel systems around critical nodes throughout the disrupted network (e.g. important passenger hubs near the disruption) and the nature of the disruption (e.g. duration, time, location). Together, these features constitute a foundation for assessing the most adept transport replacement strategies for disrupted passengers.

Passenger transport compensation strategies are characterized by having either an external (relying on local existing public transport structures) or internal focus with regards to the affected railway system (e.g. alternative replacement services, making long-distance train services available to all passengers) (Pender et al. 2013). Consequently, responding to the unpredictable circumstances behind each disruption implies matching the affected railway network with the operating conditions of the surrounding transport structures so as to minimize the burden on customers as much as possible.

Furthermore, as with operational management, addressing passenger transport compensation issues can be conducted either in an ad-hoc manner or through the implementation of DRPs. The following section explores planned approaches for passenger transport compensation strategies in detail. For approaches following ad-hoc principles, refer to Tsuchiya et al. (2006), Bouman et al. (2013) or Yin et al. (2016).

2.4.2. Planning of Transport Concepts

In the framework of DRP development, structuring proficient pre-planned transport concepts compels practitioners to take a much more holistic stance. In this regard, it becomes crucial that the planned measures included in the concept not only take into account the circumstances around which the transport compensations are to be deployed but the way in which they are shared with users.

Overall, the structuring of passenger transport compensation strategies during a disruption in any transport system is primarily focused on upholding the welfare of users (Pender et al. 2013). In this regard, the cornerstone of the DRP transport concepts and its strategies are concerned with securing passengers' mobility chain. Therefore, they strive to guarantee that passengers are able to access the necessary alternatives to reach their destination within an appropriate timeframe (e.g. wait time, travel time) and through adequate transport structures (e.g. overall capacity, number of transfers) (Chu et al. 2012).

Quintessentially, within DRPs, the arrangement of proper passenger transport rerouting strategies entails assessing:

- the mobility conditions around the stations where passengers are to be rerouted
- the best fitting measure given the operating circumstances of the existing transport services (i.e. the necessity to deploy alternative replacement services between stations, and reliance on existing public transport systems)
- communication procedures between users and the railway staff (Chu et al. 2012, Pender et al. 2013).

Determining the most critical points where the affected passengers' trips are to be addressed is entirely dependent on the disrupted circumstances and the intricacy of the railway network. After the disruption has taken place, the typology of the network changes and passengers need to readjust their travel chains (Cadarsó and Marín 2013). In this regard, a station in the railway network, where passenger exchange is to be conducted, is considered critical beyond its operational importance and instead, its relevance is determined by its potential as an intermodal transference hub. Identifying a set of stations as relevant rerouting points for passengers within DRP transport concepts implies that these spaces must be able to support the rerouting activities and provide with adequate service conditions. Firstly, they must be able to supply the basic infrastructure (e.g. platforms) and at the same time, must be able to handle the foreseen passenger flows, avoiding the generation of bottlenecks (Brauner and Oetting 2019). Furthermore, they also must count with an understanding of both the local transport and railway network condition, which entails considering the accessibility to the rerouting strategies foreseen in the DRP operating concept (e.g. availability of public transport structures, different railway services) (Brauner and Oetting 2019).

The prospect of rerouting passengers to long-distance or medium-distance train services stands at the front line of the overall replacement service possibilities (Brauner and Oetting 2019). Nevertheless, this option can be rendered impractical by either the structure of passenger trips (e.g. direction or objective of the trip) or the extent of the disruption (e.g. affecting all train traffic in the region). As a result, looking for answers outside of the railway system itself can become particularly relevant. The pursuit of intermodal strategies entails that railway users are provided with suitable alternative replacement services or they are rerouted towards the local transport structures (Pender et al. 2013). In sum, structuring the most appropriate transport compensation strategies at the relevant nodes mostly implies taking an inventory of the resources available at these specific locations.

Once the adequate rerouting prospects are asserted, there still remains the adequacy with which the strategies are shared with the affected passengers. From announcements on vehicles, platforms and stations to written messages displayed throughout the rerouting environment or sent via mobile phones, passengers gather and react to the information in various ways (Currie and Muir 2017). However, recent investigations indicate that commuters respond more effectively to the information gathered around the station or from staff members circulating on vehicles and platforms, rather than through smartphones or web-based communications (Currie and Muir 2017).

One benefit conveyed by DRPs is that pre-structured communication processes form an intrinsic part of their structure. This enables passengers and staff members to access necessary information in a shorter time span (Chu 2014). Moreover, since they are explicitly developed to fit specific situations, they can be instrumental in helping passengers to determine their best fitting transport compensation alternative. However, dealing with passengers' reactions towards disrupted operations as well as their eventual trip rerouting prospects implies contending with the intricacies behind people's overall mobility patterns and travel behaviour. Altogether, these are intricate issues, which require much broader and more detailed consideration. For a deeper insight into communication strategies during disruptions (see Boltze and Dinter 1996, Dollevoet et al. 2012, Stelzer 2016, Piner and Condry 2017, Currie and Muir 2017).

Harmonizing the process of attaining adequate operational measures with the assembly of the necessary passenger rerouting strategies and communication protocols is a key part of the

development of DRPs (Chu et al. 2012) since these qualities enable disrupted passengers to complete their journey within acceptable quality standards. However, DRP development experts can not always acquire the information necessary for a complete overview of the disrupted circumstances. This is particularly the case with regards to the operational conditions of parallel public transport systems, which do not always have the adequate capacity to deal with the additional demand (Pender et al. 2013, p.23). Therefore, a deeper discussion, including the actual character of local transportation structures within the development of intermodal passenger rerouting methods, becomes indispensable.

2.4.3. Intermodal Rerouting Strategies During Disruptions

Two fundamental intermodal strategies can be pursued and eventually combined to overcome a disrupted situation. These strategies involve pursuing an effective intermodal transfer to local public transport means (multimodal focus) or the deployment of alternative replacement services between relevant locations (generally single-mode focused). Both of these strategies are further explored below.

Alternative Replacement Services

If the passenger rerouting strategies are to be conducted in an area that lacks adequate connectivity to public transport structures or if it is assumed that the disruption might last an extended period of time (e.g. days), it is necessary to provide transport replacement services.

Replacement services rely on the use of particular vehicles to serve as a link between two disrupted stations or between a disrupted station and another relevant location (e.g. city center, airport). In general, replacement services are conducted with buses due to their operating flexibility and passenger hauling capacities, setting the groundwork for the so-called “bus bridging problem” (De-Los-Santos et al. 2012, Zeng et al. 2012). However, replacement services can also be conducted by other means of public transport (e.g. trams) and even private means (e.g. taxis) (Christoforou et al. 2016).

Structuring the replacement services is inherently contingent on the disruption characteristics (e.g. time of the day, location within the network) and the availability of resources that can be dedicated to this task (e.g. vehicles, staff, etc.) (Zeng et al. 2012, Kepaptsoglou and Karlaftis 2009).

Ultimately, since they are generally an emergency substitute or utilized to bridge locations that are not accessible by existing means of public transit, they stand as proficient means to uphold passenger transport quality (Kepaptsoglou and Karlaftis 2009).

Existing Public Transport Means

Multimodal passenger rerouting explicitly relies on existing transport structures around the railway stations where the passenger rerouting strategies are to be conducted. Under these circumstances, it becomes particularly relevant to conduct an assessment of two key determining variables: the travel alternatives provided by the available structures and their ability to absorb the demand induced by the disruption (Pender et al. 2013, Xu et al. 2015, De-Los-Santos et al. 2012).

On the one hand, assessing different travel alternatives demonstrates the extent to which a given rerouting location possesses the necessary transport structures to connect it to relevant destinations within the considered region. As discussed in subsection 2.3.3, verifying the

availability of local transport modes in a given location provides an overall picture of its relevance as a major junction or hub. On the other hand, and perhaps as the most important among determining variables, assessing the capacity limitations of the existing public transport structures reveals the actual rerouting prospects in the area and the quality with which these measures can be implemented (Pender et al. 2013, Xu et al. 2015).

Summary

Both of the aforementioned passenger rerouting options illustrate the importance of a thorough exploration of the existing transport situation at all rerouting locations. As the first factor influencing decision-making, it is critical to acquire a sufficiently informed grasp of the operating characteristics of existing public transport structures and, particularly, their ability to absorb the disrupted passengers at each one of the projected rerouting points across the railway network. Therefore, asserting the public transport systems' capacity limitations and the proficiency of its available structures to absorb the additional demand should be considered a cornerstone in structuring effective rerouting strategies.

2.4.4. Capacity Analysis

Evaluating the capacity of the public transport systems involves an extensive assessment of multiple features of the system's operational and physical components so as to project their ability to handle excess demand in a specific location.

Capacity can be interpreted in multiple ways. It circumscribes within its consideration different elements specific to the means of public transportation. Each divergent understanding of capacity carries its own significance and limitations.

In its most basic definition, the capacity of a public transport system is defined as: *"In relation to fixed resources and a quality of service objective, transport capacity is the maximum volume of flow that can be handled in standard conditions for a limited period."* (Leurent 2011, p.11). It can also be perceived through its infrastructural dimension and described as the highest number of transport units, each with its own passenger carrying capacity, which an infrastructural element is able to manage during a set timeframe (Dorbritz and Anderhub 2007, p.5). Similarly, it is also accurate to describe it as a function of operating qualities, where vehicle sizes and frequencies define the overall aptitude of the system, guided by certain quality standards or comfort criteria (Brinckerhoff 2013).

Each definition focuses on a different element within the public transport structure. As a result, the capability of any public transport system to handle passenger flows is defined by the specific features of its physical and operational components (i.e. vehicles, infrastructure, traffic protocols, and in most cases, specific quality standards).

Objectives of Capacity Analysis

The underlying objective of studying the capacity of a public transport system is to bridge passenger's mobility needs and the resulting changes in transport demand together with the availability of transport resources. In this regard, the capacity analysis concentrates on minimizing the operating resources, while maximizing passenger comfort and security (Schnieder 2015, p. 45). Consequently, the efficient balancing of these parameters rests at the core of public transport planning and management.

Public transport planning is understood as a process built mainly over two main modules: the identification of the existing transport demand or passenger travel behaviour and the proficient scheduling of the necessary services or transport supply (see Schnieder 2015, Cats et al. 2015). Both of these tasks are further detailed in the following subtitles.

Public Transport Demand

Understanding public transport demand as an extension of peoples' travel behaviour is not only of great relevance to capacity assessment but also in achieving a deeper appreciation of the public transport network potentials.

The determining variables behind passengers' travel behaviour are said to include a broad arrange of compound characteristics (e.g. urban density, land use, car ownership, journey time, etc.) (Paulley et al. 2006, Klinger et al. 2013). The complexity behind these characteristics has been explained in-depth within the "Urban Mobility Culture" framework presented by Klinger et al. (2013). The authors argue that passengers' travel behaviour results from a mixture of objective and subjective aspects that constitute local urban mobility culture. While the objective aspects range from the urban form, to transport infrastructure to socioeconomics, and can be unequivocally evaluated, the subjective aspects, constituted by people's lifestyles, attitudes, perceptions, travel behaviour (i.e. modal-split), are difficult to appraise due to their abstract nature and flexible definitions (Klinger et al. 2013).

Within capacity planning and public transport management, the intricacy behind endeavouring to identify the precise shifts in demand can be addressed, for the most part, by analyzing actual user behaviour information (Schnieder 2015) (Dorbritz and Anderhub 2007). Collecting reliable user behaviour information supports the improved planning and scheduling of public transport operations. However, this information must be reviewed acknowledging the strong of spatiotemporal influence behind the existing public transport structures and their relationship with the wider urban fabric they service (Paulley et al. 2006).

Initially, regardless of the mean of transportation being assessed, demand varies through time, from peak (referred to in German as HVZ "Hauptverkehrszeit") to off-peak (NVZ "Normalverkehrszeit" or SVZ "Schwachverkehrszeit") hours of use in the network. In essence, these periods depict the fundamental changes in demand (i.e. commuting flow) throughout the day (Dorbritz and Anderhub 2007, Schnieder 2015, Lopez et al. 2017). By the same token, public transport demand also varies throughout the week. The most significant transport demand values tend to come about during week/working days when the overall city functions (e.g. educational services, shops, industry, civil services, etc.) are entirely operational (Paulley et al. 2006). Thus, the most substantial demand transpires during peak hours on a normal working day while educational activities are also taking place.

Respectively, demand also fluctuates across space. In consequence, public transport network lines are sized to service a specific catchment area within the urban environment. The spatial distribution, density and function of the area served by a public transport line play a critical role in determining the strength of the public transport demand (VDV 2001). Additionally, the modal-split or the choice of the mode of transportation (e.g. walking, biking, public transport), which changes in concordance to the trip length, also influences the public transport demand (Walther 1991, Steierwald 2005).

Here, central urban areas (CBD or “Central Business Districts”) are by a large considered the most relevant (Lefèvre 2009, Newman and Kenworthy 2015, Paulley et al. 2006). Inner-city areas have been explained to constitute the leading objective, as they are often the source of an average trip generated within the public transport network (Lefèvre 2009 – see figure 2.7). This generalization has been first introduced in the simplified “standard urban model” or the “bid rent model” of Alonso (1964).

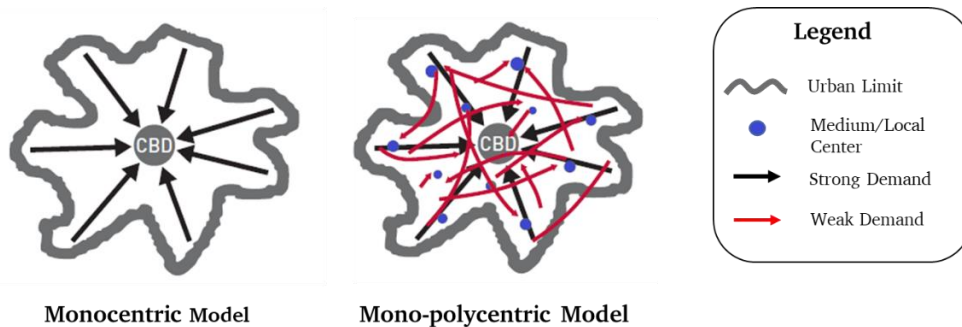

Figure 2.7 Monocentric and Mono-polycentric Urban Landscapes (Lefèvre 2009, modified by author)

The model introduced by Alonso (1964) was advanced from an economic perspective where an individual is said to maximize its utility and minimize its costs. This is then reconciled across all individuals within the investigated environment to produce equilibrium. In Alonso’s model, the price that can be bid for a given location is essentially expressed as a function of its distance from the city center. As explained by Bertaud and Malpezzi: “*It is easy to show that equilibrium requires that change in commuting costs from a movement towards or away from a central business district (CBD) or other employment node equals the change in rent from such a movement.*” (2003, p.22). This observation has been backed up by an analysis of more than forty cities across the world, demonstrating that population density tends to grow exponentially towards the main city center (e.g. CBD, old core) as the price of land increases due to competition (Bertaud and Malpezzi, 2003).

Although in the typical monocentric urban landscape, travelling patterns concentrate around the CBD area, not all cities resemble this same structure (see figure 2.7). As medium and local centers gain further relevance (i.e. mono-polycentric urban landscape), these localities become focal points for the generation and attraction of trips. These, in turn, result in polycentric cities, which have, on average, longer trips than their monocentric counterparts. Nonetheless, even with more dispersed travel patterns, as is the case in polycentric cities, there will still be one location within the entire environment with the minimum average trip length to all potential destinations known as the city’s “center of gravity” (Bertaud 2003, p.10). This center of gravity conveys similar characteristics to those of the CBD in the monocentric case; thus, the population density in even in polycentric cities also displays a negative slope measured against this “center of gravity” (Bertaud 2003). Therefore, regardless of a monocentric or a polycentric urban landscape, there is one location in the urban environment that can be referenced as being the average source and objective of all trips that are generated.

The relevance of the city center as the primary source and objective of trips generated within an urban area during weekdays has been essential for public transport capacity planning. Walther (1991) explains: “[...] *it has been proven to be a permissible abstraction of demand to assume the frequency distribution of the travelled distances of all trips for predominantly monocentric areas as demand frequencies for inner city-oriented routes [...]*” (Walther 1991, p.52 [own translation]).

Once the spatiotemporal influences on public transport demand have been considered and acknowledged, the actual transport demand information can be retrieved.

The actual public transport demand information can be gathered through a variety of approaches (e.g. passenger counts, passenger surveys, ticket sales, etc.) (see Schnieder 2015, Steierwald 2005). The most important attributes to isolate are the shifts of passenger day trips throughout the network, as explained by the spatiotemporal features. Collecting actual demand information implies recognizing strategic locations within the public transport system that are determined depending on the utilized approach (Steierwald 2005).

The most common surveying mechanisms are direct and systematical passenger counts, which recall data on the number of passengers boarding and alighting from the timetabled journeys of a particular line throughout the whole day. This information can be captured either manually or by means of Automatic Passenger Counting Systems (APCS) (see VDV 2018), and the results are useful to determining operational elements within lines (i.e. vehicle characteristics, frequencies of service). Yet, this method's network-wide applicability is limited since it does not capture information regarding transferring passengers or the beginning and the end of specific trips (Schnieder 2015).

The limitations in direct passenger counts can be offset, for example, through origin-destination (O-D) surveys, as they allow for the identification of the specific origin and destination of each trip. Nonetheless, O-D surveys have a much more complicated structure and, as such, are more difficult to evaluate.

Ultimately, the surveyed strength and spatiotemporal structure of the demand is narrowed down to decisive cross-sections across the network, to inform the scheduling of the public transport supply. These elements pinpoint the location in the network (i.e. public transport stop) with the highest load of passengers per unit of time and around which the public transport supply is sized (Schnieder 2015).

Public Transport Supply and Capacity Levels

Sizing the adequate public transport supply to cover the critical demand identified at the decisive cross-sections entails recognizing the close interplay between all fundamental elements that constitute public transport operations. This 'capacity-fitting' is a nested process, which builds on different capacity levels while it adheres to certain standards so as to service the existing demand.

Differentiating between capacity levels implies a systematic examination of the elements that constitute the public transport network's general functioning to service the critical demand. Each level yields a particular capacity related character that amounts to describe its operating conditions and transport supply limitations.

Since the capacity levels focus on sizing different system's components, it becomes apposite to discuss the structured partitioning of these elements. The differentiation provided by Dorbritz and Anderhub (2007) is very insightful. The authors divide public transport capacity into six categories: *i) passenger capacity, ii) theoretical capacity, iii) operational capacity, iv) comfort-oriented capacity, v) network and mixed traffic oriented capacity.* These categories enable a deep appreciation of the implications behind each one of the different elements that constitute the public transport system in general and are explained here in detail.

i) Passenger Capacity

This first level concentrates on the features of what is arguably the most important for public transport operations: namely, the number of people a specific vehicle type is able to transport. Consequently, it deals with vehicle characteristics throughout different transport modes.

At large, this level can be defined as the maximum number of passengers a transport unit or vehicle is able to handle (Dorbritz and Anderhub 2007). Thus, it is possible to recognize three fundamental limitations: the available number of seats, the available area for standing passengers and the overall number of passengers able to alight and board the vehicle within a specific time (Leurent 2011, p.16-17). In particular, the maximum passengers transported per vehicle differ not only between modes of transport and vehicle-models but also with existing regulations. For example, German public transport regulation adopts a maximum value of four persons per square meter for the maximum number of standing passengers in a vehicle (Dorbritz and Anderhub 2007, p.7; Schnieder 2015).

The most important characteristic of this first level focuses on the total number of passengers each vehicle is able to transport. However, for every mode, there is a broad spectrum of vehicle types (see chapter 3.3 in Schnieder 2015, p.61) and the allowable amount is tied with local transport regulations. For planning and evaluating purposes these values are standardized (as in Schnieder 2015, Dorbritz and Anderhub 2007) and an example of this is provided in table 2.5, where the averaged values for the total number (i.e. standing and sitting) of passengers per vehicle type for each transport mode are presented.

Table 2.5 Average maximum passenger hauling capabilities per vehicle type (standing and sitting) (Dorbritz and Anderhub 2007)

Public Transport Mode	Standard Bus	Articulated Bus	Tram Short	Tram Medium	Tram Long	Metro Short	Metro Long
Average (People/Vehicle)	63	92	94	180	222	274	764

ii) *Theoretical Capacity*

The theoretical capacity of a public transport line combines the previous level with the maximum number of vehicles that can be moved through a specific route in a certain period within ideal circumstances. This assumes a set of idealized conditions as the pretext for its theoretical standpoint, yet it cannot be achieved during ordinary operations.

In order to account for the highest amount of vehicles that are able to traverse a specific route, emphasis must be fixed on the succession time between moving bodies. The succession time or as it is also known “*Headway*” or “*Frequency*” refers to the time separating the run of two successive vehicles. The succession time, as explained by Dorbritz and Anderhub, depends on: “...*technical parameters that consider the safety-related and dynamic vehicle behaviors (speed, braking distance, etc.)*” (Dorbritz and Anderhub 2007, p. 10). Accordingly, to maximize the number of vehicles, the headway must be kept at its minimum operating value setting the stage for what is called the “*Minimum Headway*”. This minimum value assumes optimal conditions and unreal vehicle behaviour parameters (i.e. minimal succession distance, equal acceleration, identical braking patterns and same reaction times) (Dorbritz and Anderhub 2007). It is clear that these assumptions are used uniquely for analytical or planning purposes.

By combining the two public transport capacity planning determining variables discussed thus far, it is possible to describe the most basic capacity relation. Equation 2.16 provides a general framework to ascertain the capacity C of a particular line within a defined time period t_{def} .

$$C = \frac{V_c}{f} * t_{def} \tag{2.16}$$

Dividing the maximum passenger vehicle capacity V_c by the headway time (minimum headway) f and multiplied by the defined time period t_{def} as depicted in equation 2.16, the capacity C of a public transport line can be ascertained.

iii) Operational Capacity

To perform a more realistic assessment, the conditions within the previous level need to be expanded to include the uncertainties featured within real operations. Therefore, the operational capacity level attempts to include real operating stipulations for a much more accurate portrayal of transport capacity.

The operational capacity outlines the operational process of an actual working system, where the stability of the planned schedule is removed by three preeminent sources: the movement of vehicles through the infrastructure, the flow of passengers in and out of the vehicles and additional external consequences. From pathway configurations to working protocols and station characteristics to the vehicles operating features (e.g. acceleration, braking, etc.), there exists an immense range of uncertainties across every single vehicle run (Brinckerhoff 2013, Dorbritz and Anderhub 2007, p.10). With regards to the system-passenger interaction, vehicles stopping in a station (i.e. dwelling time) and the time necessary for the passenger exchange (i.e. boarding and alighting from a vehicle) can fluctuate considerably. Other essential features are external disturbances (e.g. weather, strikes, etc.), which not only affect the user behaviour but also the overall system operating capabilities (Schnieder, 2015). The combination of all of these limiting aspects affects the possible headway time between vehicles.

Operators and planners create specific restrictions to handle these uncertainties and stabilize the planned schedule, thus lowering the theoretical capacity of the system (Dorbritz and Anderhub 2007, p.10). The most common technique is to add additional surcharges to the actual driving time of the vehicles and enlarge the time between runs of two sequential vehicles by including the so-called: “buffer time” between runs (see Schnieder 2015). “Buffer time” is a fixed interval that compensates, to some extent, for deviations in the planned operations. It derives from practical experience, and it is widely utilized in mass transport operations since it allows for the operating process to achieve some constancy despite the fact that it is said to reduce the theoretical capacity by half (Dorbritz and Anderhub 2007, p.10).

iv) Comfort Oriented Capacity

The comfort-oriented capacity is built on notions of passenger welfare and demand considerations. At this level, minimum pre-established standards guide the system’s operational qualities across fluctuations in demand, while obliging operators to abide within explicit constraints that protect the welfare of users.

The quality standards include a regulatory framework, which imposes specific occupancy limitations on the vehicles throughout the day. The limitations are intended to uphold user comfort by limiting the degrees of freedom with which system components may be appointed to match the changes in demand. It is said that during peak-hours (HVZ), passengers accept a higher occupancy rate within the vehicles. However, in the German guideline for public transport, it is stated that the occupancy rate as an average value during the HVZ ought not to exceed 80% over a 20-minute-peak and 65% over a one-hour peak (VDV 2001). On the other hand, during NVZ, the average occupancy should not surmount 50%, as passengers tend to secure a sitting place in the vehicle (Dorbritz and Anderhub 2007, Schnieder 2015).

In the long run, the service quality of a route determines the passenger’s travel choice (Leurent 2011, p.20). Ultimately, introducing limitations to the maximum occupancy of the vehicles and

projecting these to the collected passenger transport demand data allows for the identification of the necessary characteristics of vehicle sizes, frequencies, etc.

v) *Network and Mixed Traffic Oriented Capacity*

The network includes the totality of public transport lines that service a particular area (Schnieder 2015). Thus, the network and mixed traffic oriented capacity contemplate all lines and modes of public transportation that constitute the public transport network and considers the interaction between different means of transport (including private means of transport) and its influence on capacity (Dorbritz and Anderhub 2007).

From route organization to route management, public transport lines can be described along with their geometric and spatial characteristics such as: ring lines, radial lines, diametrical lines and tangential lines (see figure 2.8, top). Once the routes are organized, they inherently relate to each other, and these qualities set the foundations for the overall network structure. Clear examples of the interplay between routes towards the assembly of a network are depicted in figure 2.8 (bottom).

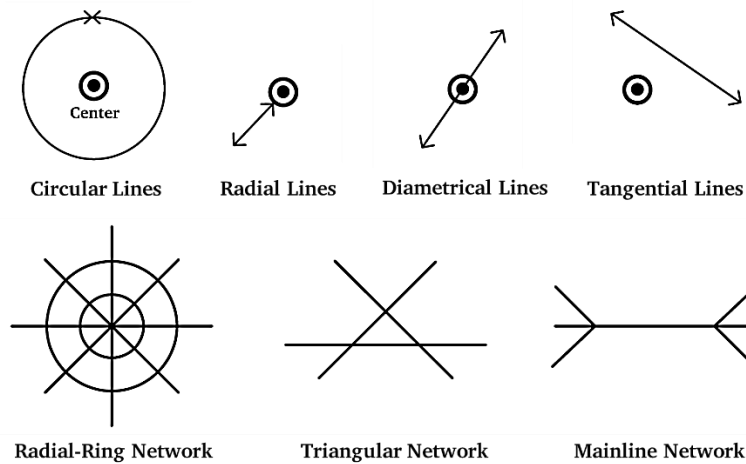

Figure 2.8 Top: Spatial arrangement of Lines; Bottom: Composite Network forms (Schnieder 2015; modified by author)

While the line's geometric and spatial features are decisive in outlining the network's overall structure, their juxtaposition within networks also allows recognizing both the operating qualities of the vehicles (Leurent 2011) and the general accessibility of the network (Paulley et al. 2006). Therefore, this last capacity planning level is particularly relevant for implementation purposes and decisive in the development of transport policies.

The considerations advanced within this capacity planning level expand the understanding of available instruments aimed at stabilizing the schedule. It suggests a further increase in driving time surcharges and buffer times to account for the existing traffic and the interaction between different transport modes that share sections of infrastructure (i.e. dependent and independent portions of a public transport line) (Dorbritz and Anderhub 2007, Schnieder 2015). The driving surcharges and buffer times are appointed depending on the interaction of the public transport line under consideration with other types of traffic.

Subway systems are the best example of independent public transport lines, where the network and mixed traffic oriented capacity are similar to the comfort-oriented capacity since there is no interaction between different transport modes. On the other hand, bus systems are a proficient example of dependent public transport lines, since their interaction with different modes of transport is very likely.

Altogether, the network and mixed traffic oriented capacity lead to an even further decrease in the public transport schedulable capacity.

Summary

Public transport operations are planned such that passengers reach their destination in an appropriate timeframe (e.g. wait time, travel time) through adequate structures (e.g. overall capacity, number of transfers). Together the qualities of the combined network elements and their outlined characteristics bring about efficiency and quality-oriented response to the ever-present fluctuations in public transport demand within a given operational environment. Therefore, the remaining gap between scheduled and demanded capacity reveals a relevant feature within public transport operations, namely, residual capacity.

2.4.5. Implications of the Residual Capacity

Basic Principles

Residual capacity is sometimes referred to using different terminologies throughout the public transport literature. From reserve capacity (Cats and Jenelius 2015), spare capacity (Xu et al. 2015), to most utilized residual capacity (Xu et al. 2015, Cats et al. 2015, Jin et al. 2014), authors use different terms to denote the same feature, namely, a direct relation between scheduled and used capacities or the gap between demand and supply.

For instance, the term reserve capacity denotes a built-in feature across different public transport elements (e.g. vehicles, crew allocation, etc.), which is employed to increase their robustness and mitigate the impacts of disruptions (Cats and Jenelius 2015). The authors Mattson and Jenelius (2015) expand this understanding to include a framework that contemplates the vulnerability of all public urban mobility structures (e.g. railway systems, public transit, etc.) and see it as a “network-wide” robust quality. Xu et al. (2015) define the residual capacity from the perspective of travellers’ and planners’ and describe it as a general network quality to improve redundancy, contingent on route choices, travelling modes and congestion effects.

The term residual capacity delineates a parallel understanding of all the above-discussed perspectives, yet it assumes a much more microscopic understanding. Essentially, it makes reference to the remaining passenger hauling capabilities within a particular vehicle (Cats et al. 2015), or the deliberate ability to absorb supplementary demand (Jin et al. 2014). Therefore, the residual capacity not only refers to the existing gap between the scheduled capacity and the used capacity (considering passenger travel behaviour), but it also refers to the implications on the operation of specific vehicles under strained situations.

In this work, the term residual capacity is utilized to refer to the unutilized capacity within a public transport vehicle throughout its route, which may be utilized for the intermodal rerouting of disrupted passengers. Therefore, the term inherently considers the residual capacity as a planned robust characteristic of a public transport network that can be utilized regardless of the public transport mode being affected. In general terms, the residual capacity $RC_{j,n}$ of a public transport mode j at a point n is described as the result of multiplying its scheduled capacity C_j by one minus the occupancy rate $OR_{j,n}$ of a public transport mode j assessed at point n . The relation is structured in equation 2.17.

$$RC_{j,n} = C_j (1 - OR_{j,n}) \quad (2.17)$$

Since capacity planning is dedicated to keeping the gap between the scheduled services and the spatial and temporal variations of passenger flows as tight as possible, it inherently minimizes the residual capacity of the system. Conversely, there are benefits to upholding a certain degree of capacity robustness within the public transport system's operating structures. Public transport robustness, fostered in part through a built-in reserve capacity, is said to allow the system to increase user welfare and better cope with disrupted situations (Cats and Jenelius 2015).

Committing to minimizing the residual capacity, even while following strict transport-quality standards, implies building potential vulnerabilities within the system while exposing passenger's welfare (Cats and Jenelius 2015, Mattsson and Jenelius 2015, Jin et al. 2014). The absence of reserve operating resources makes the system less reactive to deviations in the planned operations (Mattsson and Jenelius 2015) and vastly reduces service reliability (Cats et al. 2015). Therefore, the same notion of maintaining a supply-demand equilibrium, which makes the system resource efficient during regular operations, can potentially constitute a source of vulnerability during disrupted operations.

Evaluating the Residual Capacity

An evaluation of the residual capacity for the purpose of the intermodal rerouting of disrupted passengers not only identifies the system's aptitude to absorb the additional demand (Mattsson and Jenelius 2015) but also the extent to which the rerouting strategies can be successfully implemented across space and time. As a whole, the residual capacity is a determinant factor in the potential of public transport networks to cope with extreme events, like, for example, an extensive offset of capacity requirement from another disrupted transport structure. This is the particular case during the development of the DRP transport concepts as part of planned disruption-management approaches, where the residual capacity of existing public transportation offsets the loss in capacity caused by a disruption within a railway network. Such benefits are of great relevance in the framework of passenger rerouting strategies; however, the extent of the benefits of increasing the residual capacity have not yet been fully asserted (Cats and Jenelius 2015).

Furthermore, a key path towards enhancing robustness potentials lies in the integration between different transport systems (e.g. between commuter rail and or further public transport services) and an increased capacity in different sections of the network (Jin et al. 2014, p.19; Cats and Jenelius 2015). Assessing the robustness of a particular transport network requires an appreciation for multiple transport elements. To this end, different models have been developed.

Currently, there are multiple models that allow for the assessment of public transport residual capacity and its temporal variations.

Though centred in road networks, Ziyou and Song (2002) developed an origin-destination (O-D) route choice model to maximize residual capacity. Snelder et al. (2012); Chen et al. (2013), enhanced the previous model for public transport purposes in order to assess the residual capacity and its relevance during extreme scenarios. Cats and Jenelius (2015) develop a similar O-D model to identify the lines that would benefit the most from an expansion of their residual capacity when specific network links are disrupted. Xu et al. (2015) organized a method to assess the magnitude of the residual capacity for multi-modal public transport network links by taking into consideration congestion and simulated passenger flow through different nodes. Cats et al. (2015) put forward a public transport demand-supply framework to identify passenger capacity variations throughout specific lines of the network. In the particular case of disrupted situations, De-Los-Santos et al.

(2012) propose a model that assesses the ability of a railway network to react to disruptions by relying on the residual capacity provided by intermodal rerouting strategies.

As common qualities, the models currently available emphasize the prominence of passenger flow and management of demand to boost the residual capacity of the public transport network's elements and components during both normal and disrupted operations. Furthermore, the above-described models highlight the intricacies behind assessing relevant public transport components to determine the appropriate residual capacity.

On the other hand, none of the discussed models places exclusive focus on the influx of disrupted passengers from external transportation systems such as railway networks. Additionally, none of the models provide any insight or attempts to explain the changes in residual capacity within a single public transport vehicle along its route. The general scholarly debate runs thin when it comes to methods that allow for simple, and general estimation of capacity limitations of existing public transport vehicles for the pursuit of intermodal rerouting strategies during railway disrupted situations.

Structuring a framework that allows for a prompt estimation of the passenger rerouting potentials at any given point of a commuter railway network towards existing public transport structures can prove to have overarching relevance for the development and deployment of passenger intermodal rerouting strategies.

Summary

The residual capacity estimation relates the scheduled capacity of a public transport structure (e.g. vehicle, line, etc.) with the OR. The scheduled capacity, as acknowledged in equation 2.16, directly includes matters of vehicle capacities and operational frequencies. The OR circumscribes in one parameter the complex nature of public transport demand (i.e. as described in subsection 2.4.4.), differentiating through a percentage value the utilized and the available capacity in a vehicle, line or set of lines. Furthermore, additional elements to appreciate for explaining the OR are: the critical cross-section of a line, service intervals and direction of the passenger flow (see VDV 2001 and subsection 2.4.4). All in all, the residual capacity is built over a relationship between public transport supply and demand, and any attempt made to evaluate its magnitude must strictly adhere to this principle.

2.5. Closing Remarks

An examination of the relevant, state-of-the-art literature demonstrates that there is no clear and consistent path towards overcoming disrupted circumstances in railway networks with proven efficiency. As detailed in subsection 2.3, the core of the disruption-management approaches is constituted by three key operational tasks: schedule adjustment, rolling stock rescheduling and crew rescheduling. Moreover, it has also been pointed out that parallel to the three operational problems, a proficient disruption-management also tackles the passenger transport compensation matters.

The consideration of the existing literature has allowed for an appreciation of the limited line of inquiry conducted into the inclusion of DRPs within the development of decision-support mechanisms for disrupted situations. As a result, issues as the ones pinpointed by Gahemi et al. (2016) and those intrinsically linked with the objectives outlining the deployment of DRPs have not yet been fully explored (e.g. rapid transitioning to steady operations). While much of the

attention has been focused on the development and validation of the DRP operating concepts (see subsection 2.3.3), issues behind the deployment of their operational or transport concepts on the actual disrupted situations have not been fully addressed (see subsection 2.3.3).

The literature review has also allowed evidencing the lack of methods able to simultaneously and purposefully address more than one of the three disruption-management issues (subsection 2.3). Whereas feasible approaches that deal with the schedule adjustment during disrupted situations already exist, their emphasis is on the exploration of exact solutions by means of microscopic infrastructure models or exact mathematical optimization techniques. As a consequence, the existing real-time decision-support models tend to disproportionately exchange the ability to include a wider set of disruption-management issues, for securing a more exhaustive assessment of solutions. A prime example of this is the limited extent to which existing models deal with rolling stock, crew rescheduling issues or the scope and components behind their evaluation functions.

	Operating Concept		Transport Concept	
	Process	Existing Research	Process	Existing Research
Development Phase	Evaluation of DRPs on the basis of their transitional phase	Chu et al. (2012); Chu (2014); Brauner (2019)	Validation of DRPs on the basis of their transport concepts	Brauner and Oetting (2019), Partially Addressed
Deployment Phase	On the actual operating situation	Nakamura et al. (2011) Not addressed until this point	Passenger-flow and behaviour	Not addressed until this point
	On the actual availability of infrastructure	Not addressed until this point	The actual availability of alternatives	Not addressed until this point

Figure 2.9 Existing research voids within planned disruption-management (by author)

Furthermore, relying on the existing literature examined in subsections 2.3 and 2.4, as well as the overall framework supporting the planned disruption-management approaches that have been depicted in figure 2.6, the voids which have not been addressed thus far can be clearly mapped out. The identified voids for both the developmental and deployment levels of the operating and transport concepts are displayed in figure 2.9.

Initially, the proficient development and evaluation of the DRP operating concepts have been addressed by the methods and models introduced by Chu et al. (2012), Chu (2014) and Brauner (2019). Moreover, the development of transport concepts and the validation of the resulting DRPs based on passenger welfare has been approached introduced in Brauner and Oetting (2019). However, the passenger intermodal rerouting strategies utilized to develop the measures within the transport concepts have not been included or been validated against the capacity limitation of the existing public transport means.

Moreover, there is little research available that addresses or supports the deployment phase of both operating and transport concepts. Currently, the implementation of the DRP operating concepts to the actual operating situation is currently conducted manually by dispatchers. Only the approach of Nakamura et al. (2011), addresses this specific issue; however, it fails to address any of the pitfalls identified in Gahemi et al. (2016). The same can be concluded for the adjustment of DRPs to the available infrastructure. Correspondingly, there are not available approaches that allow a dynamic deployment of the DRP transport concepts to the actual operating situation and their dynamic adjustment to the available infrastructure.

3. Objectives and Overall Approach

3.1. General Objective

The importance of railway systems within the urban environment and their relevance as critical infrastructures has been clearly underlined throughout section 1. As with other critical infrastructures, the inherent complexity of railway systems accentuates the imminence of the occurrence of disturbances and disruptions during their operations. Since the rescheduling of railway operations is a convoluted task (see subsection 2.2 and 2.3), decision-makers must take critical and complex decisions within uncertain circumstances in short periods of time.

As discussed in subsection 2.3, each of the decisions taken by dispatchers for the handling of the disrupted operations is of high relevance for the overall efficiency of the network, ultimately affecting passenger welfare to varying extents. To uphold, as much as possible, the operational quality during a disruption and swiftly address the randomly induced circumstances, decision-makers rely on: coping mechanisms (e.g. DRPs, decision-support software, etc.) and the availability of specialized resources (e.g. experienced dispatchers). Consequently, the development of enhanced support mechanisms for disruption-management (e.g. decision-support models) is of central importance as they allow dispatchers to rapidly ascertain more informed solutions and reduce reactions based on subjective factors.

An examination of the relevant, state-of-the-art literature indicates that there is no clear and consistent approach to addressing disrupted railway operations with proven efficiency. The literature review has highlighted a limited number of methods able to simultaneously and purposefully address more than a couple of the disruption-management problems at a time (i.e. schedule adjustment, rolling stock rescheduling and crew rescheduling) and even fewer methods that simultaneously deal with passenger transport compensation strategies. While feasible approaches already exist, particularly to support the handling of precise and isolated disruption-management problems through an ad-hoc approach, there remains a lack of models that effectively address more than one problem (see subsection 2.3.2).

On the other hand, within planned disruption-management approaches, DRPs are able to provide a methodological umbrella to handle the disrupted operations. Despite the different obstacles that characterize the current DRP deployment practices, their pre-planned operating and transport concepts provide instrumental information to support a comprehensive and structured disruption-management (see subsection 2.3.3). This work addresses the debate on the implementation of planned disruption-management approaches, as P&P strategies that seek to uphold the efficiency, effectiveness and service quality of disrupted railway networks.

Overall, the present work strives to enhance planned disruption-management approaches (i.e. P&P strategies) by addressing the existing voids in the framework supporting the development and deployment of DRPs. Ultimately, it is by addressing the existing voids within the discussed P&P strategies of railway systems that the resilience of these critical infrastructures can be advanced.

While DRPs provide an adequate foundation upon which to address both disruption-management and passenger transport compensation problems systematically, there are still latent issues regarding their development and deployment (see subsections 2.3.3 and 2.4). Table 3.1 provides a summary of the existing research-voids identified in the literature review, and the specific areas being addressed throughout this work.

Table 3.1 Unaffected research voids within DRP Development and Deployment (by author)

	Operating Concept		Transport Concept	
	Process	Existing Research	Process	Existing Research
Development Phase	Evaluation of DRPs on the basis of their transitional phase	Chu et al. (2012); Chu (2014); Brauner (2019)	Validation of DRPs on the basis of their transport concepts	Brauner and Oetting (2019); Addressed in <i>Section 1</i>
Deployment Phase	On the actual operating situation	Addressed in <i>Section 2</i>	Passenger-flow and behaviour	Not addressed until this point
	On the actual availability of infrastructure	Not addressed until this point	The actual availability of alternatives	Not addressed until this point

As generalized in table 3.1, this work covers both the development and deployment phases of DRPs. Since each of the voids addressed in this work concentrate on a different phase and even concept of the DRP framework, they are to be regarded as being essentially different and unrelated. Throughout the development of this work, each of these distinct voids will be addressed in a specific ‘Section’, as detailed in table 3.1.

Initially, the remaining shortcomings within the developmental structure of DRP transport concepts are addressed in *Section 1*. More specifically, as discussed in subsection 2.4.5, there is a remaining lack of approaches that permit to take into consideration the capacity limitations of the local means of public transport to validate the operating concepts. Evaluating the capacity limitation of the local means of public transport enables the development of improved passenger rerouting measures (see subsection 2.4). *Section 1* introduces the capacity limitations of the local means of public transportation during the development of passenger rerouting strategies.

The second highlighted area of table 3.1 focuses on the deployment of DRP operating concepts and the lack of a framework to support and guide their deployment on the actual operating situation. This remains a major source of vulnerabilities, as active dispatcher engagement is needed to match the actual operating situation of the disrupted network and DRP operating concepts with the circulating trains, particularly at the beginning of the DRP deployment (see subsection 2.3.3). *Section 2* puts forward a framework that supports and guides the dynamic deployment of DRP operating concepts to the actual operating situation. Such a framework would serve as a semi-automated decision-support tool for dispatchers. The framework can not be regarded as being fully automatic, as the actual availability of the infrastructure is not yet being supported by the inquiry (see subsection 2.3.3 and table 3.1).

3.2. Specific Objectives

This subsection describes the specific objectives for each of the *Sections* established in subsection 3.1. The objectives are laid out in detail and later complemented with a discussion of their respective requirements, limitations and general development methods.

3.2.1. Section 1 – Residual Capacity for Passenger Rerouting

Section 1 addresses the passenger rerouting measures during the development of DRP transport concepts, where user comfort, as well as transport quality, are the target outcomes to be considered within the overall structure, as discussed in Brauner and Oetting (2019).

At the outset, the means for the development of DRP transport concepts that are compatible with the operational concepts are already in place (see subsection 2.3.3 and 2.4). However, the development of transport compensation strategies that rely on the rerouting of passengers from the disrupted railway networks to other existing means of public transport does not yet consider the capability of these systems to withstand this additional demand. Whereas the constant availability of public transport structures permits a swift solution to satisfy the needs of disrupted passengers, as discussed in subsection 2.5.5, approaches that can be successfully included within the DRP validation framework have not yet been developed.

An inquiry aimed in this direction is intended to ensure the development and implementation of transport compensation strategies, namely, the intermodal exchange, which takes into account and upholds the welfare of railway and public transport passengers. For instance, a disruption taking place during rush hour may radically disturb the capacity of a specific railway line and severely impact upon its users. In this case, the DRP transport concept would contemplate the rerouting of passengers towards other existing means of transport, as a compensation measure. Under this framework, it becomes essential to identify the operating conditions of the means of public transportation available in the area and their ability to service the supplementary demand; in other words: identify their residual capacity.

Therefore, the specific objective of the first *Section* entails the development of a model that allows decision-makers to generate passenger intermodal rerouting strategies that take into consideration the residual capacity of local public transport systems within any operational environment. In this way, the strategies within the DRP transport concepts, which must still be negotiated and validated by local public transport operators, can be developed based on a much more representative consideration of the actual operating environment, thus, enhancing their quality.

3.2.2. Section 2 – Dynamic Deployment of Disruption Programs

Section 2 addresses the development of a framework that supports the dynamic deployment of the DRP operating concept to the actual operating situation. Until now, this task, including the overall disruption-management problems, has been completed manually by the dispatchers. As pointed out in subsection 2.3.3, the manual deployment of the line-specific DRP operating concepts is not reliable. Overall, the current deployment practice is highly influenced by subjective factors (e.g. dispatchers experience) where the reaction times are inadequate, and due to the complexity of the problem, the basis upon which decisions are made is limited in scope. Therefore, a semi-automated system that supports the dynamic deployment of the DRP operating concepts would prove highly beneficial.

Existing approaches, which are almost solely based on ad-hoc disruption-management principles (see subsection 2.3) often perform an exhaustive bottom-up search for precise solutions and derive complex models that can not support actual dispatching practices. Decision-support systems designed to address disrupted situations by means of highly context-specific approaches have an overall marginal benefit, as they can not be adapted and generalized due to their complexity. While the quality of the solutions obtained through exact and context-specific approaches is upheld, they are forced to leave aside a wider set of critical influences. For example, approaches that rely on exact methods like the ones discussed in subsection 2.3.2 permit to compute a very detailed solution for a specific interaction between trains within a given portion of the network. However, they do not take into consideration the effects on broader aspects, for example, the influence of the solutions on the circulation plan of the affected trains. Such characteristics have a direct impact

on the overall disruption-management, as it restricts the share as well as the extent of disruption-management problems that may be addressed and, ultimately, the dispatching measures that may be utilized to address the disrupted operations. All in all, imposing a significant number of constraints during the handling of the disrupted operations to uphold the accuracy of the solutions radically limits the ability to adapt and provide comprehensive management of the disrupted operations.

The specific objective of the second *Section* is to fill the existing gap by developing a system capable of gathering the benefits of the already developed and tested line-specific DRP operational concepts and supporting their dynamic deployment on the actual operating situation of the disrupted network. Overall, this *Section* must address the four improvement recommendations introduced in the work of Oetting and Chu (2013) (see subsection 2.3.3). It is expected that by introducing existing DRP operating concepts within a semi-automated decision-support mechanism, the necessary means to pre-emptively diagnose the effects of the disruption from a line-specific standpoint, supporting a more effective and efficient transition to stable operations, may be attained. At the same time, with the integration of current dispatching practices within such a decision-support mechanism, all relevant solution possibilities for the affected lines vis-à-vis the actual operating situation induced by the disruption are explored, and the practical relevance of the proposed solutions is upheld.

Consequently, the specific objective of the second *Section* entails the development of a dynamic DRP deployment system, which must not only focus on the actual disrupted situation in correspondence to the chosen DRP operating concept, but also on securing that the disrupted network is capable to transition to stable operations. Ultimately, as a decision-support tool that is based on the line-specific measures foreseen in the chosen DRP operating concept, the expected outcome of such a dynamic DRP deployment system is to derive a conflict-free schedule with the sufficient quality to secure its practical implementation and which secures the capability of the disrupted railway network to transition to the stable phase as foreseen by the DRP operating concept.

3.3. Content Limitation

In this subsection, the limitations of each of the *Sections* are identified, considering the characteristics of each specific void in the framework of DRP development and deployment.

First and foremost, due to the complexity and size of the addressed problems, a developmental field valid for both *Sections* is acknowledged. The selection of a developmental field would permit to ground the analysis within a solid context and ensure that the derived frameworks fit a concrete structure. In this regard, selecting a developmental field would frame the approaches within an actual operating environment, like the operating structure and magnitude of the railway networks being considered. Ultimately, the resulting frameworks can be later adjusted to fit different developmental fields.

In the context of this work, commuter railway networks stand as an adept developmental field as they have been utilized before in previous models, as discussed in subsection 2.3.3. Overall, commuter railway networks entail mostly homogenous traffic and are also characterized by having very dense operating programs, particularly during peak hours across its mainlines (see subsection 1.3). To this end, for both of the independent *Sections* in this work, the German commuter railway

networks “S-Bahn” and their respective DRPs are used as developmental fields to further the objectives of the study.

3.3.1. Section 1 – Residual Capacity for Passenger Rerouting

As detailed in subsection 3.2, the first *Section* of this work concentrates on establishing a model that allows taking into consideration the capacity limitation of existing public transport means during the development of passenger rerouting strategies within DRPs’ transport concepts. As discussed in subsection 2.4, taking into consideration the capacity limitations of available public transport systems entail an estimation of their residual capacity.

For the identification of the residual capacity of public transport systems, the framework of capacity planning discussed throughout subsection 2.4.4, and the complexity behind its determining variables described in subsection 2.4.4 acquire particular relevance. In this regard, assessing the residual capacity of any public transport line at any point in its route entails streamlining key determining variables within capacity planning. The model’s estimation of the residual capacity is therefore confined within the framework of public transport capacity planning and management.

Since public transport capacity planning and management are intrinsically set to cover a long-term time horizon, it provides the model with a baseline to extend the residual capacity estimation across the passenger rerouting strategies that want to be incorporated in the DRP transport concept. However, since these strategies still need to be negotiated and verified with local public transport operators, only a general rough estimate of the capacity limitation is required. Consequently, as the model is set to provide a rough estimate of the residual capacity, its overall complexity is limited, which enables the prompt appraisal of the modelled circumstances, and secures its inclusion in the general verification process of the DRPs’ operating concept.

Furthermore, since the model is intended for the validation purposes of already structured rerouting strategies, it is limited to conduct the estimation of the residual capacity at pre-established locations in the public transport networks. Thus, the model does not need to support the modelling of passenger flows, the existence of alternative replacement services (see subsection 2.4.3), the selection of specific corridors or even the specific means of public transport.

All in all, the model is limited to conduct an estimation of the residual capacity of existing means of public transport instead of its in-depth assessment. Furthermore, since the residual capacity estimation is used to evaluate strategies within a DRP operating concept, it is limited to addressing the first two assessment objectives of the DRPs’ transport concepts discussed in subsection 2.4.2. Thus, communication between users, decision-makers and staff members falls outside of the model’s developmental framework.

3.3.2. Section 2 – Dynamic Deployment of Disruption Programs

This subsection establishes the limitations of the dynamic DRP deployment system as a decision-support tool, which allows deploying a chosen DRP to the actual operating situation.

At the outset, the dynamic DRP deployment system is limited to address disruptions in railway passenger transport, more specifically, in networks with already developed and tested DRP operating concepts. As discussed above, German commuter railway networks “S-Bahn” are used

as the developmental field to further assemble the structure of the system. Thus, the structure of the dynamic DRP deployment system proposed in this work is tailored to deal with disrupted operations within the commuter railway networks. By focusing the system's design on commuter railway systems as its developmental field entails that the dispatching measures and the operational characteristics being considered must be compatible with those applied within commuter railway operations (e.g. limited overall size of the network, high density of the operating programs, etc.).

Furthermore, within commuter railway operations, the connection between train services of the same network or with train services outside of the system is rarely established. Therefore, connection conflicts, as described in subsection 2.2.3, are not handled within the dynamic DRP deployment system. Another important aspect relevant for commuter railway operations, particularly during disruptions, is considering the movements of empty trains from and to different parking locations (i.e. shunting movements). While the handling of shunting movements is of relevance, these are conducted partially only considering the portion until the vehicles have left the commuter railway relevant infrastructure.

Since the second *Section's* specific objective calls for the development of a dynamic DRP deployment system capable of adjusting a schedule to the actual operating situation, the system is framed within the systematic identification and resolution of any conflict types and the dispatching measures that allow trains and affected lines to overcome the conflicts induced by the disruptive events. Therefore, for developing and establishing specific components of the dynamic DRP deployment system within the established implementing field, there are no explicit limitations regarding the utilization of measures or approaches that have been discussed throughout subsections 2.2 and 2.3 and which support the identification or resolution of conflicts.

Moreover, since the development of the system seeks to fill one of the remaining gaps (see table 3.1) hindering the deployment of the DRPs' operating concepts to the actual disrupted situation, it tackles the lack of a framework outlining the deployment of the DRP within the transition phase. Therefore, any forgoing processes are not directly included in the scope of this work. Aspects like the development of the DRP operating concepts, the assessment of the disrupted situation and any other investigations that need to be conducted before choosing a specific DRP from the set of DRPs available for the network lay outside the scope of this work. So is the modelling of the disruption's innate characteristics (e.g. disruption length, change of the disrupted situation through time), for which existing approaches have already been introduced (see subsection 2.3). By the same token, the adjustment of the DRP operating concepts to the available infrastructure (i.e. infrastructure not available due to maintenance or construction works) or the deployment context are also left outside of the scope of this work, as the dynamic DRP deployment system is set provide the necessary platform for their subsequent advancement (see table 3.1).

Furthermore, as it has been discussed in subsection 2.3, most of the existing approaches concentrate their computational efforts on addressing one of the three central disruption-management problems. In particular, existing approaches that provide decision-support in real-time stress an unavoidable trade-off between accuracy, the systematic handling of the disrupted network from a practical perspective, and the computational effort. Nonetheless, the dynamic DRP deployment system, as a decision-support mechanism, is directed towards attaining a conflict-free schedule that deals with more than one disruption-management problem, during actual disrupted operations and under predefined computational circumstances. While the system is advanced as a decision-support mechanism, it is implemented the moment the DRP has been declared, starting

the disruption-management process. Consequently, the limits on the computational effort available can be shifted with respect to the implementation context to uphold the effective and efficient handling of the disrupted situation. Thus, to avoid limiting the dynamic DRP deployment system's practical relevance, the complexity within each of its framework components are considered and made as efficient and effective as possible. However, to avoid indiscriminate limitations being included in an attempt to minimize the computational effort, the adequate paths towards adjusting the overall framework complexity are highlighted within each introduced component.

Ultimately, testing the system in an actual operating environment is not within the scope of this work. Consequently, not every assumption made to structure the system can be fully validated, and therefore, the main emphasis is on the design of each of the system's components. By the same token, the design of the user interface and visual representations of the system are also not addressed in this work.

3.4. Requirements

This subsection gathers and discusses the requirements for a model with general validity in line with the specific objective and limitations outlined in subsection 3.2.1 and 3.3.1.

3.4.1. Section 1 – Residual Capacity for Passenger Rerouting

The model must be structured within the selected implementation environment in such a way that it can be included within the developmental structure of the DRP transport concepts (e.g. Brauner and Oetting 2019).

The model to be developed as part of this *Section* must allow decision-makers to generate passenger intermodal rerouting strategies that take into consideration the residual capacity of local public transport systems. In due course, the model must be capable of performing the residual capacity estimation on each of the considered means of public transport in a mode and line-specific fashion at each established rerouting location while taking into consideration the welfare of local public transport users (i.e. securing that only the residual capacity of the local means is utilized for the rerouting of passengers).

Despite that the model must be easily applicable to a broad range of operating situations and border conditions (i.e. urban and operational characteristics), it must deliver sufficient accuracy to make its implementation relevant in definite circumstances. Particularly, regarding the time of day and most specifically distinguishing between peak and off-peak hours (i.e. HVZ, NVZ and SVZ).

The logical structure must not only support a prompt estimation of the residual capacity by changing its inputs but also ensure that the results provide enough accuracy for decision making. Therefore, the most relevant features across public transport capacity planning and management (discussed in subsection 2.4.4) must be strategically identified, isolated and parameterized.

In the same vein, to refrain from structuring a model that requires exceptional and complex processes to be conducted before its implementation, careful consideration is required to ascertain the key determining variables within public transport capacity planning and management.

In the particular case of public transport capacity issues, special attention must be paid to the determining variables that require an extensive context-specific assessment, thus deepening the

complexity of the problem at hand (e.g. demand dependent determining variables - occupancy). The handling of these determining variables must be validated and made applicable to any public transport network without a need for special or local modifications.

As discussed in subsection 3.1, the study makes use of the example of German commuter railway systems and their DRPs. This is particularly relevant for deriving and testing of the model's necessary assumptions. Therefore, information regarding the passenger exchange records to ascertain the changes in the vehicle-specific occupancy across multiple public transport modes and networks must be acquired within the confinements of Germany's public transport networks, as they work in parallel with commuter railway systems. To further uphold the general validity of the resulting model, information from the most utilized public transport modes should be acquired, namely, buses, light rail and subway networks.

Overall, the model developed within this *Section* must not only be able to effectively estimate public transport capacity limitations within a broad range of operating circumstances but also it must do so for all available means of public transportation just by observing the most relevant determining variables. A model encompassing these characteristics can be advanced in multiple ways. That said, the methods used for the development of said model need to be selected such that they provide enough flexibility to deal with the uncertainties behind the context-specific operating circumstances.

3.4.2. Section 2 – Dynamic Deployment of Disruption Programs

The requirements for the development of the dynamic DRP deployment system, as defined in the specific objectives of this *Section*, are presented with meticulous detail in the following paragraphs.

As discussed in subsection 3.2.2, the dynamic DRP deployment system is aimed at closing the gap between the DRP line-specific operational concepts and the actual disrupted circumstances by establishing a conflict-free schedule with sufficient quality to ensure its practical implementation. The proficiency of the system is highlighted by its ability to serve as a semi-automated decision-support mechanism with general validity (i.e. not context-specific) that allows systematically tackling broader disruption-management problems guided by the DRP operant concepts.

So that the DRPs can be purposefully integrated into an actual decision-support system, the obstacles engendered by current implementing practices must be addressed. Here, the static nature of DRPs and the lack of a clear outline guiding the system to stability, pose the most significant challenges. Of particular importance are the considerations made in Ghaemi et al. (2016), which can be immediately aligned with the identified lack of a dynamic DRP deployment framework (see subsection 2.3.2 and 2.3.3).

At the outset, the dynamic DRP deployment system must be able to transfer the measures detailed in the line-specific DRP operating concept to every single train in the network. It must do so while considering the three central disruption-management problems (see subsection 2.3), a special focus on capacity consumption, the network's transition to stable operations and the particular characteristics of the disruption. This also highlights the relevance of trying to avoid discrimination between trains based solely on the relevance of their slots (i.e. their priority - train services on express-passenger slots).

Overall, from current DRP deployment practices, the particular characteristics of the actual disruption to be considered are:

-
- the time of day of its occurrence (i.e. time of the day HVZ, NVZ or, SVZ),
 - all affected infrastructural elements,
 - and the actual location of trains circulating in the network as well as their operating condition at the moment the disruption has become manifest.

More specifically, the trains' operating condition, which must be recognized, entails information such as their current delay and whether they have been directly affected by the disruption.

With the specific characteristics of disruption identified, the dynamic deployment system must be able to adapt the line-specific measures detailed in the chosen DRP operating concept according to the actual time of day and the trains circulating in the network with a specific train service number.

Guided by the chosen DRP operating concept, all trains in the network must be handled utilizing all dispatching practices available and applicable for the selected implementing field. Consequently, as the system handles all train services scheduled to operate in the disrupted network, the resulting conflict-free schedule must have a train number and minute-specific precision.

On the one hand, supporting a train number precision entails ensuring that for the attainment of the conflict-free schedule, all train services in the original schedule are handled and taken into account (i.e. train number specific).

On the other hand, a minute-specific precision entails that the conflict-free schedule must include information about each of the train services with an accuracy of seconds.

As evidenced across the available disruption-management models discussed in subsection 2.3, before structuring any decision-support system to be implemented within disrupted railway operations, it is necessary to establish the disruption-management problems that are being addressed (i.e. schedule adjustment, rolling stock rescheduling, and crew rescheduling). While tackling all three problems is crucial for proficient management of the disrupted situation, to fulfill this *Section's* specific objective, some issues acquire more relevance than others (see subsection 3.2.2).

i) Schedule Adjustment

Firstly, by striving for a conflict-free schedule, its adjustment requires that all train services in the network's original schedule are explicitly handled to abide by the actual disrupted operations. Within the context of planned disruption-management approaches, the successful adjustment of the schedule demands that each train service is adjusted as determined by its line-specific DRP operating program in such a way that the network can reach stability without overlooking the passengers' welfare.

Moreover, to ensure that the adjustment is ultimately conflict-free, all conflict types discussed in subsection 2.2.3 must be handled, namely, occupancy, infrastructure availability, circulation, and connection conflicts.

It must be considered that the handling of certain conflict types already involves addressing further disruption-management problems. Such is the case of circulation conflicts, which institute the need to address rolling stock rescheduling matters.

By the same token, the handling of all conflict types must also be aligned with the commuter railway operations as the system's implementing field.

Here, connection conflicts are of particular importance as planned connections are rarely established due to the dense nature of the commuter railway operating programs. Consequently, since connection conflicts are, for the most part, non-existent, the dynamic DRP deployment system must find adequate means to track and uphold the service quality of the disrupted network exclusively from the passengers' perspective.

ii) Rolling Stock Rescheduling

Secondly, to achieve a conflict-free schedule with practical relevance, the rolling stock rescheduling problem also requires further attention. Existing models that effectively deal with rolling stock rescheduling are able to address the problem by incorporating an already adjusted schedule (see subsection 2.3.1). However, existing models do not provide sufficient evidence to support the feasibility and effectiveness behind handling the schedule adjustment and the rolling stock rescheduling independently one after the other.

For handling rolling stock rescheduling somewhat in parallel with the adjustment of the schedule, particular attention must be given to the rolling stock rescheduling tasks which are relevant for the proficient adjustment of the schedule. From reviewing existing rolling stock rescheduling models, the central tasks may be summarized as: adjustment of the circulation plans, scheduling shunting movements, end-of-day imbalances and abiding with maintenance restrictions (see subsection 2.2.3 and 2.3.1). Since the proposed system must generate a conflict-free schedule with a train number precision, the adjustment of the schedule must be conducted in parallel with the adjustment of the circulation plans. Additionally, the scheduling of shunting movements and dealing with the end-of-day imbalances should still be taken into account to verify the quality of the adjusted circulation plans.

Furthermore, since the developmental field has been established within the framework of commuter railway systems, which involves networks with a relatively limited geographical size when compared to other railway networks (e.g. long-distance, regional), vehicle maintenance restrictions are not particularly critical and can be disregarded. Likewise, since commuter railway services are intended for daily utilization, no passenger reservations are required. However, to uphold the service quality and passenger welfare, the offered passenger transport capacity embodied in the vehicle compositions, which are appointed to each of the scheduled train services throughout the day, must still be carefully taken into consideration.

iii) Crew Rescheduling

Thirdly, crew rescheduling is also necessary for upholding the service quality and the practical relevance of the strived conflict-free schedule; yet addressing this problem in its entirety would introduce additional complexity within the dynamic DRP deployment system.

While addressing the crew rescheduling in full is not critical to fulfilling this *Section's* specific objective, one aspect may still be considered during the development of the conflict-free schedule. Ensuring that a train is able to reach the specific location (e.g. stations) in the networks where its crewmembers must be replaced may be supported by the system. Introducing such a constraint during the adjustment of the schedule and circulation plans would allow the system to further enhance its practical relevance.

Therefore, the system must incorporate the necessary constraints during the adjustment of the schedule and circulation plans to ensure the trains are able to reach specific locations in the network where crewmembers are being replaced within the duration of the disruption.

As a result, from the review of each of the three disruption-management problems, the proposed system must support the adjustment of the schedule as well as circulation plans, and indirectly, incorporating the scheduling of shunting movements, end-of-day imbalances, and crew availability, as overall constraints.

Moreover, as the system is framed within planned disruption-management principles, it must be aligned with the existing DRP development and deployment framework. Therefore, not only must the system acknowledge the existence of the different phases that are involved in the deployment of the DRPs, which includes the transitioning of the disrupted operations to stability, but also the current approaches utilized in their manual implementation (e.g. DRP set-up - see subsection 2.3.3).

In due course, the system ought to be provided with adequate means for efficiently and effectively exploring as many dispatching measures compatible with the strategies outlined in the line-specific DRP operating program as possible. Dispatching measures supporting the adjustment of the schedule and circulation plans must be carefully explored for every train circulating in the network to the extent that they abide by the DRP operating concept of their respective lines, the disrupted operations, and the network's ability to transition to stable operations.

The ability of the dynamic DRP deployment system to support the network's transition to stable operations permits to grasp the relevance behind the handling of trains in the immediate vicinity of the disrupted section (see subsection 2.3). Consequently, the system must also be able to support the adequate handling of the queuing of trains in front of stations, particularly throughout stations in the vicinity of the disrupted sections. Here is where the system-specific focus on capacity consumption acquires special attention.

Furthermore, while the focus is centred on handling a disrupted commuter railway network, the interaction with other railway traffic types (e.g. freight trains, regional trains) must also be supported. However, the ability of the system to support these interactions depends on the degree of detail in which the information regarding other railway operations is made available to the system.

For securing a system able to function within the stringent conditions of a decision-support system, the computational time to complete the deployment of the line-specific DRP operating concept during the actual disrupted situation must be minimized. Therefore, as outlined by the above-discussed requirements, the conflict-free schedule must be assembled in the shortest time possible without disproportionately compromising the feasibility of its solutions (i.e. ability to reach stable operation, explore as many dispatching measures for each train, obtain a conflict as well as deadlock-free schedule). Nonetheless, as discussed in subsection 3.3.2, to further support the development of a system with general validity, its structure must be made adjustable to better support the available computational effort.

Overall, the dynamic DRP deployment system developed within this *Section* must not only be able to derive a conflict-free schedule by implementing the line-specific DRP operating program to every scheduled train service within the uncertainty of disrupted operations but also guarantee that the network can transition to stable operations. A dynamic DRP deployment system with such

characteristics may be advanced following a broad range of different methods. Nevertheless, the methods utilized for establishing the strived system must be selected considering the extent as well as the complexity of the addressed problems, and the need for a flexible and automatized structure with general validity able to adhere to a broad range of potential implementation environments.

3.5. Methods

Selecting the most suitable approach to address the problems being tackled in this work requires the close consideration of the requirements, constraints as well as the targeted outcomes of the undertaking as a whole. The investigative approach leading the development of both the residual capacity estimation model (i.e. *Section 1*) and the dynamic DRP deployment as a decision-support system (i.e. *Section 2*) envisioned in this research respond to the compound conditions of its objects of study (i.e. public transport capacity analysis and disrupted railway operations). This subsection explores different methodological alternatives and derives the logical frameworks required to fulfill the specific objectives of both *Sections* addressed in this work.

Overall, the importance of transport infrastructures to the urban dynamic is evident (see section 1). It is clear that together, railway and local public transport networks stand as critical components within the daily affairs of urban environments. What is more, the entwined character of mass transport systems themselves, combined with a wide range of urban functions, composes highly complex and interconnected processes and relations. Therefore, the research methodology must recognize and adjust to the complexity behind the problems addressed in each of the models being put forward.

A substantial number of methods could be applied to structure approaches capable of achieving the objectives pursued in both *Sections*. Subsection 3.5.1 discusses these diverse methods, and later the most appropriate methodology for each of the *Sections* is discussed in subsection 3.5.2. Finally, from the methodology established in subsection 3.5.2, the structure of the overall approach for each of the *Sections* is derived and discussed in subsection 3.5.3.

3.5.1. Overview of the Available Methods

There are different methods that can be utilized to establish the logical frameworks required across both *Sections* of this work. The available methods are found within the context of Operations Research, which is inherently associated with the methods already discussed in subsection 2.2.4. An overall introduction to Operations Research can be found in the work of Hillier and Lieberman (2015), and an overview regarding their application within the area of traffic and transport is provided in Boltze et al. (2007).

Overall, among all available methods, those who facilitate the decision-making and optimization of assets are of particular interest for advancing the logical frameworks. Such methods have been utilized in the existing models discussed throughout subsections 2.3 and 2.4. The most employed methods can be summarized in four general clusters, namely, exact, metaheuristic, rule-based and fuzzy logic methods. Each of the four clusters is further discussed in the following subtitles.

Exact methods

Exact methods generate an optimal solution through a detailed examination of a number of uncertainties, making this process a highly composite undertaking. To formulate the problem, exact methods require strict border conditions, constraints and an objective function. The way in

which each of these elements is derived is immediately reflected in the quality of the obtained solutions. There are multiple approaches within the family of exact methods.

The first exact method considered here is uninformed search methods, such as *brute force methods*. These only access the problem's constraints and definitions and perform an unguided exploration of possible solutions. Often these methods apply full enumeration techniques and explore the search space by arranging it in a structured form (most commonly as a search tree). Due to their unguided exploration of the search space, they have limited efficiency and are better suited to address problems with small search spaces.

Furthermore, informed search methods, like *Branch-&-Bound* or *A* search algorithms*, retrieve not only the constraints and definitions of the problem but also the objective function. This allows them to establish different bounds in the search space and single out areas that may or may not be explored. By establishing these limitations, these methods are able to address more complex problems. Nevertheless, the computational time grows with the complexity of the problem.

Ultimately, *linear programming (LP)* and *integer linear programs (ILP)* are the most common approaches to deal with optimization problems. Linear programs observe a series of inequalities to describe the search space, where a solution can only be accepted if it satisfies all conditions established by the inequalities.

LP approaches deal with problems within the complexity class P (i.e. problems that can be solved in polynomial time). The higher the number the constraints and decision variables, the more complex the problem becomes, which also influences its computation time to find a solution. The solution in *LP* is represented as a vector constituted by real numbers, which must be weighed by the objective function. In concordance with the context of the problem, the objective function is either a minimizing or maximizing function.

In the case of *ILP*, the solution vector and the program handles only integers. Together *LP* and *ILP* are recognized as *mixed-integer linear programs (MIP or MILP)*. When integers are allowed within the solution vector, the search space becomes more complex, and the modelling of constraints, as well as the computational time, becomes problematic. It is common to use relaxation techniques within *ILP* approaches, as the means to establish the bounds (i.e. upper and lower bounds) of the addressed problem and support a much more efficient solution.

Metaheuristics

The complexity of many problems and the circumstances in which they need to be addressed limit the ability to implement certain methods (e.g. exact). Therefore, it becomes necessary to sacrifice the accuracy of the solution to obtain a solution within a reduced temporal timespan or even to obtain a solution at all. In response to this problem, different approximation methods, also called heuristics, have been developed. Heuristics allow obtaining a near-optimum or "good enough" solution to complex problems within much stringent temporal limits. The better-known methods include decomposition, constructive, and local search approaches (Martí and Reinelt 2011, p.19).

Decomposition methods dissect the larger problem into smaller sub-problems, dividing it across both variables and constraints. There are no clear rules to decide how to divide the problem or in how many sections and this is decided in correspondence with the problem being addressed.

Constructive methods start by assembling an empty framework of a solution and explore the search space by generating different solutions alternatives and adding the best portions of the alternatives to the empty framework. This process occurs until the framework is complete.

Local search approaches require an initial solution. Then, they explore the search space in the immediate vicinity of the initial solution by applying certain changes and generating possible solutions. This is done iteratively until one of the solutions fulfills some predefined criteria.

One attribute of heuristic methods is that they are highly problem-dependent and therefore tailored to address one specific problem. However, metaheuristic methods are, for the most part, problem-independent. These can be separated into two groups: single-state and population methods (Michalewicz and Fogel 2004).

Single-state methods require an initial solution. Then, they proceed to select and modify certain aspects of the solution in an attempt to explore the search space. These methods rely on a selection technique to choose the aspects of the solution that will be modified to derive better solutions. This process is repeated until one or more termination criteria have been met. The most common single-state methods are: Hill Climbing, Simulated Annealing, Tabu Search, Iterated Local Search and Single-State Global Optimization Algorithms.

Population methods are in principle similar to single-state methods; however, they consider a sample of solutions to explore the search space, all of which are involved in seeking the improvement of the current condition. Examples of population methods are: Evolutionary Algorithm, Genetic Algorithm, Particle Swarm Optimization.

The flexibility of both heuristic and metaheuristic methods demands the institution of ground rules to regulate the performance and quality of their solutions. The results must devise three specific properties in order to prove their proficiency: firstly, the solution must be obtained with a reasonable computational timeframe; secondly, the solution must be near-optimal; and finally, the probability of providing a deficient solution must be minimized (Martí and Reinelt 2011, p.18).

Rule-Based Methods

Rule-based methods compensate for uncertainties by making assumptions. This, in turn, makes the examination process less intricate, yet they then require robust guidelines that limit their applicability (Martí and Reinelt, 2011). Rule-based methods can be classified as metaheuristic approaches and have excelled as machine learning techniques.

At their core, rule-based systems are encoded with expert knowledge as “If-Then” rules to explore the search space. They are also called “expert systems”, as they emulate decisions taken by experts, and their implementation is limited to search spaces that can be structured following If-Then principles. Depending on the number of rules required to cover all the problem’s restrictions, the applicability of a metaheuristic method can be limited, since incorporating too many rules may render the approach unstable by increasing computation effort. Ultimately, the quality of the results varies widely, since they are highly sensitive to the adeptness with which the facts and rules that constitute the system are defined as well as by the search strategy used to move and chose the different rules.

Fuzzy-Logic

Fuzzy-logic merges abstract concepts with mathematical representation. Through the use of the “Fuzzy set” theory, convoluted logical linguistic concepts can be modelled mathematically. These

methods have been successfully used to deal with complex natural processes by building models based on mapping different inputs and outputs (Zadeh 1965). Fuzzy methods have also excelled in dealing with problems with incomplete knowledge or stochastic uncertainty.

Overall, the application of the method requires two tasks: fuzzy modelling and fuzzy optimization. Fuzzy modelling breaks the problem into a series of cause-and-effect functions, which are transformed and included in pre-defined reference sets. The fuzzy optimization then employs optimization techniques adapted to work within its structure (e.g. fuzzy rule-based methods or fuzzy linear programming). Finally, the results obtained must be processed once again for proper interpretation.

3.5.2. Method Selection and Structuring of the General Approach

With the requirements, constraints, as well as the targeted outcomes of each of the *Sections* in mind (see subsection 3.2), it is essential to adopt a method that delivers an adequate degree of flexibility and can cope with uncertainty, while simultaneously proving applicable in diverse and complex contexts.

For the residual capacity estimation model (i.e. *Section 1*), the requirements and limitations (see subsection 3.3.1 and 3.4.1) outline the development of an approach that must be able to estimate the residual capacity of a public transport network under the widest range possible of operational conditions. This implies the absence of strict border conditions in which the analysis is to be performed. Moreover, the intrinsic difficulty behind attempting to predict and estimate public transport utilization as a means to derive the residual capacity also denotes a certain degree of uncertainty that must be dealt with in the targeted model.

For the second *Section*, the dynamic DRP deployment system is projected as a decision-support tool to be implemented during real-time operations and aimed at deriving a conflict-free schedule to address the actual disrupted railway operations. While the intended system counts with the DRP operating concepts as its overall guideline, the necessity to attain a flexible system with general validity weakens the existence of any of the strict border conditions that can be derived from the operating concepts. Therefore, the flexibility of the required system puts further stress on the computational complexity of the problems which need to be addressed. Overall, the computational complexity of the problems being tackled (i.e. scheduling, rescheduling) have been deemed to be NP-hard problems (Brucker 2007). The computational complexity can be further acknowledged across the single tasks that must be fulfilled during the rescheduling of the railway operations. For example, the routing of trains throughout a railway station has been reckoned as an NP-complete problem (Kroon et al. 1997); likewise, Budai et al. (2010) proves that the adjustment of the circulation plans and the rebalancing of the vehicles amounts to an NP-hard problem. As a result, exact methods have very limited applicability for addressing the aspects tackled within the second *Section* of this work.

Adding yet another layer of complexity, the framework in which the models advanced in both *Sections* of this work must fit within the existing paradigm of DRP development and deployment. Altogether the above-discussed characteristics limit the eligibility of method that can be employed for advancing the approaches required in both *Sections* of this work.

From the range of available methods, the majority require specific knowledge of the border conditions and a clear operational framework in order to foster the development of a comprehensive and accurate solution. Building the necessary approaches, therefore, means

circumventing both the intricacies of public transport user behaviour and the emergent uncertainties in railway operations during the advent of a disruption. Consequently, it is implausible to imagine two exact approaches that take into consideration all necessary constraints and are able to perform within the requirements of both of the *Sections* of this work.

Heuristic and metaheuristic methods deliver within their structure the flexibility necessary to shape the models while embracing their limitations. They do so by sanctioning the use of induction and analogies through experiences, practice and intuition. Therefore, the ability of these methods to incorporate compound conditions within the evaluation of the search space is particularly useful to this work.

Both heuristic and metaheuristic methods have been widely applied to arrive at solutions based on best approximations, which deal with real and complex problems (Festa, 2014). Not only do they compensate for existing uncertainties with assumptions that lessen the effort of the assessment, but they are also able to attain optimal solutions at a local scale through trial and error (Martí and Reinelt, 2011). Considering the limitations, analytical conditions and requirements of this study, heuristic and metaheuristic methods stand among the best alternatives for supporting the successful development of approaches in both *Sections*.

As discussed in subsection 3.2, the methodology structured to address the specific objectives of each *Section* of this work is described in detail throughout the next subtitles.

Section 1 – Residual Capacity for Passenger Rerouting

To address the specific objective of *Section 1* (see subsection 3.2.1), the approach behind the residual capacity estimation model is discussed.

As discussed in subsection 3.4.1, the model must be advanced within the developmental structure of the passenger rerouting strategies of the DRP transport concepts as a means to incorporate the capacity limitation issues of the existing means of public transport. Here, two issues are important: securing a model that supports being included as an assessing tool for the development of rerouting strategies within DRP transport concepts (for any commuter railway network) and the handling of the determining variables that require previous appraisal for the estimation of the residual capacity (e.g. public transport demand or occupancy).

The overall structuring of the model is guided by decomposition and constructive heuristic methods and assembled through a rule-based algorithm. Initially, the problem is broken down into sub-problems so that each smaller problem is easier to address. Each sub-problem is dealt with by following the principles of constructive methods, where every aspect of the problem is to be solved and later incorporated into the general structure. Ultimately, a residual capacity estimation model can be combined into a rule-based algorithm assisted by graph theory so that the objective of *Section 1* can be fulfilled.

Following the literature review in subsection 2.5, the residual capacity estimation consists of contrasting scheduled and utilized capacity. Therefore, considering the implementation field, the overall problem can be divided into three sub-problems: estimating the scheduled capacity of the existing public transport means, estimating the occupancy rate of the public transport means and ultimately, joining them in the overall structure that supports the estimation of the residual capacity as part of DRP developmental framework.

At the outset, the scheduling of the public transport assets has been discussed in detail throughout subsection 2.4.4. The approach to address the first sub-problem advances specific strategies and generic processes to keep track of the scheduled assets within the public transport network by singling out only the most relevant determining variables for estimating the residual capacity. Furthermore, since the model should be able to address the available public transport systems interconnected with the German commuter railway network (i.e. the test implementing field), only aspects from these specific systems are supported within the generic processes to be included later in the targeted model.

As discussed in subsection 2.4.4, estimating the occupancy rate is a much more convoluted procedure. The occupancy rate has a strong connection with the passengers' complex travel behaviour. Within capacity planning, passenger public transport demand is studied periodically to adjust the system to the users' needs. In the case of the strived model, there is neither the possibility to study every single locality nor to do so on a regular basis. Therefore, the need to conduct additional evaluations to ascertain key determining variables to explain the demand and appraise the occupancy rate of vehicles can be dealt with in different manners. Frequently, the complexity of the model is stepped-up to match the complexity of the modelled phenomenon. Prime examples of this are the O-D and passenger-flow simulation models discussed in subsection 2.5.5. However, these approaches are not compatible with the specific objectives of the model (i.e. a prompt and rough estimation of the residual capacity). One way to offset the complexity is by introducing assumptions informed on the modelled phenomenon and include a general account of these assumptions in the model's structure. To avoid a disproportional loss of accuracy, the formulated assumptions need to be tested to corroborate their functionality and legitimacy. The testing the formulated assumptions requires to capture and process actual operating information from the implementing field. Although processing the data and testing the assumptions may be a strenuous process, this only needs to be done once for the overall structure of the model to maintain limited complexity and immediate applicability.

By this point, the approach has established the general operating conditions of the available public transport networks and key determining variables necessary to carry the residual capacity estimation. Ultimately, the two previously discussed sub-problems can be put together into an overall structure, which permits conducting a general estimation of the residual capacity of the available public transport as part of passenger rerouting strategies foreseen in the DRP transport concept being evaluated.

Section 2 – Dynamic Deployment of Disruption Programs

The approach behind the dynamic DRP deployment system is envisioned as a semi-automated decision-support mechanism for the deployment of the DRP operating concepts to the actual disrupted operations. In this subtitle, the dynamic DRP deployment system's approach is derived and discussed in detail.

Overall, the envisioned decision-support system is framed within planned disruption-management approaches and aligned with the existing practices that currently support the manual deployment of the DRP operating concepts to the actual disrupted situation (see subsection 2.3.3). The dynamic DRP deployment system is intended for delivering a train number and a minute-specific conflict-free schedule while upholding the network's ability to transition to stable operations. As the means to advance the envisioned system's logical structure and sharpen its scope, the operational structure of the German commuter railway networks "S-Bahn" and their respective DRPs have been chosen as the system's developmental field (see subsection 3.3).

At the outset, the line-specific DRP operating concepts provide preliminary access to essential information in the form of a feasible operating program outlining the line-specific measures to achieve the stable operation of all lines affected by a specific disrupted scenario (see table 2.4). With the information contained in the chosen DRP operating concept, the line-specific conflicts regarding the number of vehicles required to service the chosen DRP plus the geographical extent of the affected train services can be identified. Therefore, by contrasting the targeted DRP operating concept with the actual operating situation in the network, the initial dispatching challenges that need to be addressed across each of the network's affected lines and the potentially significant dispatching measures that allow tackling these challenges, can be acquired.

While the line-specific DRP operating concepts allow ascertaining the initial dispatching challenges affecting all the trains appointed to a particular line, specific handling measures still need to be transferred to each individual train (i.e. vehicle-specific level). In contrast, existing approaches that follow ad-hoc disruption-management principles are conducted uniquely at the vehicle-specific level as they do not count with the overview of the operating situation across each of the affected lines provided by the DRP operating concept (see subsection 2.3.1). Thus, a substantial benefit may be attained from devising adept means to transfer the information contained within the line-specific DRP operating concepts to each of the trains circulating in the network. In due course, the adept transference of this information would lay the groundwork to derive a conflict-free schedule while supporting the network's transition to stable operations.

Consequently, there are two core tasks which need to be supported in this *Section's* approach, namely, the transfer of the measures contained in the line-specific DRP operating concept to each of the trains circulating in the network (so as to establish the best dispatching measure for every train), and ultimately, performing the actual schedule and circulation plan adjustment so as to establish the strived conflict-free schedule while guaranteeing the network's transition to stability.

As discussed at the beginning of this subsection, heuristic methods provide a solid foundation to build the structure of the strived dynamic DRP deployment system. However, there are multiple heuristic approaches that can be utilized to establish a system that fulfills this *Section's* requirements (see subsection 3.4.2). A general overview of two heuristic paths, which are framed within the two core tasks, are briefly discussed below.

- Aligned with the current (i.e. manual) DRP deployment practices, rule-based methods can be utilized for establishing the dynamic DRP deployment system. An “expert system” with clear rules and guided by the DRP operating concept can be able to support the transference of line-specific strategies to vehicle-specific dispatching measures for all the trains circulating in the network in correspondence to their respective lines. Within the “expert system” a set of different If-Then rules can be established to allocate each train with the dispatching measure that better fits the actual operating situation, ultimately, assembling the strived conflict-free schedule.
- A different approach can make explicit use of existing heuristics CDCR processes. In order to support the fulfillment of the two tasks foreseen within this *Section*, the CDCR process would need to be implemented across line-specific and vehicle-specific operational levels. Beginning at the line-specific level, a CDCR process would rely on the DRP operating concept to identify line-specific conflicts and potential resolution alternatives that can be transferred to the vehicle-specific level. Later, the line-specific resolution alternatives can be systematically appointed to the trains, where a different CDCR process this time

implemented at the vehicle-specific level would derive the strived conflict-free schedule. Additional heuristic or metaheuristic methods can be included to develop the necessary process within every step of the approach.

The first approach relies on the utilization of rule-based methods, which requires establishing a decision-making structure that must cover every possible instance. Such a convoluted structure would not be compatible with the need to establish a system with a flexible and generally valid structure (see subsection 3.4.2). Additionally, in order to support the allocation of specific dispatching measures following If-Then rules, the interaction between different trains would need to be systematically categorized and prioritized. Prioritizing the handling of trains is not aligned with the need to perform an exploration of the broadest range possible of potential solutions required to uphold the practical relevance of the proposed system (see subsection 3.4.2). On the other hand, the second approach requires advancing a system with a structure able to support all the essential processes required to address the CDCR (i.e. identification, classification, sorting and resolution of conflicts). The need to support such a broad range of processes without a clear set of constraints would stand as an obstacle for the need to secure an effective and efficient system.

While each of the above-discussed approaches brings about their own particular set of obstacles, a combination of both heuristic paths is expected to deliver a much more robust structure. As a result, the approach presented in this *Section* relies on the existing heuristics coupled rule-based methods, which are extended from the existing DRP implementing practices (see subsection 2.3.3). Overall, the resulting approach seeks to enhance the effectiveness and efficiency of the resulting system as it differentiates between line-specific and vehicle-specific operational levels and incorporates within each of these levels a CDCR approach supported by rules derived from actual DRP deployment practices. By projecting the CDCR process on two operational levels, the resulting approach would differentiate between line-specific and vehicle-specific conflicts, which would simultaneously introduce two specific needs. On the one hand, different elemental conflict solution alternatives as a set of predefined dispatching measures should be examined for their capability to solve conflicts at each one of the operational levels being handled by the system. On the other hand, once different conflict resolution alternatives have been established at the line-specific level, these must be applied at the vehicle-specific level.

Initially, at the line-specific operational level, disruption-induced conflicts affecting entire lines, which may only be identified by means of the implementation of an DRP operating concept are identified as line-specific conflicts. The identified conflicts can be adeptly classified and sorted as in existing CDCR approaches (see subsection 2.2.3), which would also allow establishing potential conflict solution alternatives that better address the identified conflict. Once potential line-specific solution alternatives have been identified, these may be transferred at the vehicle-specific level. A vehicle-specific CDCR approach can be later utilized to systematically explore the implementation of the potential line-specific solution alternatives on every train circulating in the network and establish a series of candidate conflict-free schedules. Ultimately, an evaluation function targeted at establishing the best possible combination of measures appointed to the specific trains would permit to identify the best possible conflict-free schedule among all generated candidates.

The approach within each of the operational levels is discussed in detail throughout the following paragraphs.

i) Line-Specific Level

At the core of the line-specific operational level stands both the DRP operating concept and the elemental conflict solution alternatives, which are to be implemented across all lines affected by the disruption and seeking their transition to stable operations.

Once the best fitting DRP operating concept from the set of DRPs available for the network is manually chosen for the specific disruption, the dynamic DRP deployment system can be implemented. At the outset, the chosen DRP operating concept should be set-up, as discussed in subsection 2.3.3. The DRP operating concept and its set-up would permit to identify line-specific conflicts, which should be classified and sorted in a line-specific conflict list so that they can be resolved.

Line-specific conflicts constitute operating challenges that can only be addressed by considering the line as a whole and can not be isolated to an individual train. In the context of the planned disruption-management approaches (see subsection 2.3.3), line-specific conflicts are directly related to the chosen DRP operating concept and the operating situation of the network. This implies that the measures detailed in the line-specific DRP operating concept, since they have been developed to cope with one precise disrupted scenario (see subsection 2.3.3), may facilitate the means to identify the line-specific conflicts. Therefore, through a close consideration of the measures that can be implemented as part of a DRP operating concept (see table 2.4), two different line-specific conflict types can be derived.

On the one hand, the existence of either a surplus or lack of vehicles circulating in the network can be ascertained in correspondence to the disrupted operating situation of a line and due to the changes foresaw in the line's operating program introduced by the DRP operating concept. As a result, vehicle availability would constitute the first line-specific conflict to be addressed by the system. On the other hand, due to a complete blockage of the network induced by the disruption or the DRP operating concept of a line, a train can not service their originally planned route and would fail to reach all of the stations appointed in its schedule. As a result, reachability conflicts would constitute the second line-specific conflict to be addressed by the system.

A classification of the identified line-specific conflicts, aligned with existing CDCR approaches (see subsection 2.2.3), would support the identification of potential conflict solutions alternatives at the line-specific level (i.e. dispatching measures). The identified potential conflict solutions can be appointed to the trains servicing a given line from a bundle of predefined elemental conflict solution alternatives, as foreseen in by the requirements (see subsection 3.4.2). With said information, a series of conflict solution alternatives can be isolated for every single train in order to solve the line-specific conflicts that affect their lines.

The development of the conflict resolution alternatives at the line-specific operational level amounts to allocating the potential conflict solution alternatives at the line-specific level to each of the trains circulating in the network. However, every conflict solution alternative that is allocated to a train can be further combined with a spatial exploration of different alternatives as well. This would entail a combination of the conflict solution alternatives appointed to a train and the train's ability to reach different infrastructural elements, expanding the search of different options to solve the line-specific conflicts (e.g. rerouting alternatives, turning stations outside of the commuter railway system). Furthermore, abiding by the system requirements (see subsection 3.4.2), the circulation plan of each of the vehicle or vehicle compositions that constitute the train must also be adjusted. Since the adjustment of the circulation plan entails exploring a series of potential transition train services from a given line that can be appointed to the vehicle or vehicle

composition, this problem should also be also addressed at the line-specific level. Consequently, the development of comprehensive conflict solution alternatives at the line-specific operational level would require a combination of three basic components (i.e. handling alternatives) for every single train circulating in the network:

- potential conflict solutions alternatives to address conflicts at the line-specific level (i.e. dispatching measures),
- infrastructural elements that support in the process of solving the line-specific conflicts,
- potential transition train services to adjust the circulation plans.

Every single one of the solution alternatives developed for a train would have a different influence on the operating situation of the disrupted network. Since the system requirements foresee the exploration of as many alternatives as possible to derive the strived conflict-free schedule, the necessary means to combine the different solutions and derive the conflict resolution alternatives at the line-specific level should be established (see subsection 3.4.2).

The development of the conflict resolution alternatives at the line-specific level can be conducted based on different approaches. On the one hand, the solution alternatives can be developed separately by focusing individually on each of the three basic components described above. This approach would entail differentiating the exploration of solution alternatives in time and space for the adjustment of the schedule and transition train services for the adjustment of the circulation plans. Furthermore, it would also require the means to align and combine the solution alternatives so as to later identify the ones that are more compatible with the actual operating situation of the network. On the other hand, the conflict solution alternatives can be developed considering a selection and combination of all three basic components together. For this approach, a process that is able to conduct a spatiotemporal exploration of the solution alternatives for the adjustment of the schedule combined with an exploration of potential transition train service for the adjustment of the circulation plans must be derived.

The approach that foresees the individual exploration of alternatives can be supported by a heuristic exploration (see subsection 3.5.1), which starts with one of the three components and systematically reduces the possibilities until it establishes one or more alternatives for each of the components. While this approach would allow a very efficient exploration of the solution alternatives for every train, the lack of a comprehensive understanding of their combination on the operating situation would most likely reduce and simplify the search space to a degree in which the solutions would not be compatible with the system requirements (see subsection 3.4.2).

The approach that considers the exploration of conflict resolution alternatives covering all three basic components would entail a heuristic process (see subsection 3.5.1), which allows the systematic combination of the handling alternatives and the establishment of conflict resolution alternatives that encompass all three basic components that constitute the handling alternatives. Whereas this approach would support the development of a wide range of solutions for each of the trains as it combines different alternatives from the list of components, it would also require to generate multiple conflict resolution alternatives for every train in the network. Such a thorough exploration of the search space may have a substantial influence on the complexity of the whole system and on the required computational effort. However, if the necessary means to curb the complexity are incorporated in the approach, it would be the most compatible with the system requirements (see subsection 3.4.2).

Therefore, under consideration of the benefits and drawbacks of each of the considered approaches, the line-specific conflict resolution alternatives should be developed by an approach that contemplates all alternatives simultaneously, and it is able to curb the complexity in the development of the conflict resolution alternatives.

Aligned with the chosen approach, the development of the conflict resolution alternatives may be conducted by establishing Potential Vehicle-Specific Conflict Solutions in Time and Space (PVSCS) for every single train that services the respective line. The different PVSCS should be developed under consideration of the two disruption-management problems being addressed by the dynamic DRP deployment system, namely, the adjustment of the schedule and circulation plans.

A series of PVSCS can be generated for a train by merging key line-specific elemental conflict solution with a series of potential transition train services for the modification of its circulation plan and a series of infrastructural elements considering its actual location in the network. Like this, each PVSCS would contain the fundamental spatiotemporal information and a set of transition train services to support the system's capability to adjust both the schedule and circulation plans, as foreseen by the requirements. In addition, it would also support the exploration of different dispatching measures that can be appointed to the train (see subsection 3.4.2.). Ultimately, all PVSCS developed for a train can be stored in a set of PVSCS.

So that the quality of the resulting conflict-free schedule can be reinforced, the widest range possible of relevant PVSCS for every single train in the network is to be developed. However, in order to ensure the effectiveness and efficiency of the system as discussed in the requirements (see subsection 3.4.2), the complexity during the development of each PVSCS is to be limited.

One alternative to limit the complexity is to guarantee that only technically and operationally feasible PVSCS are introduced in the resulting PVSCS set of every train. The models reviewed throughout subsections 2.2 and 2.3 provide general principles that can be utilized to assess the technical and operational feasibility of each PVSCS. For example, utilizing the principles discussed in Brauner (2019) (see subsection 2.3.3) and where certain alternatives are deemed to have operational feasibility, if they permit to achieve stability, and technical feasibility, if the train model matches the infrastructure requirements along its route.

Another alternative to curb complexity is to limit the interaction with other trains in the disrupted network by considering an empty network during the development of each train's PVSCS. This alternative would amount to the introduction of the two-step repairing heuristics utilized in models like Chiang et al. (1998) or Budai et al. (2010), where an initial solution is established only to be repaired in later steps. In the case of the proposed approach, the limited interaction between trains during the development of each PVSCS may be addressed in later steps. The two-step repairing heuristic is particularly compatible with the envisioned structure as conflicts between trains can be handled at the vehicle-specific level.

Another alternative to curb complexity is to avoid the need for performing complex rescheduling procedures during the development of each PVSCS. Since all PVSCS would be repaired in later steps as foreseen by the two-step heuristic, during their development, complex spatiotemporal adjustments to each of the trains' original schedule to support their movement through the network can also be avoided. Therefore, an approach similar to the right-shift rescheduling heuristic introduced in Acuña-Agost (2009) can be implemented. The right-shift rescheduling heuristic is based on the utilization of a train's original schedule (i.e. journey times, platform tracks in stations, etc.) to derive an initial solution by following the assumption that the best possible solutions will

be close to the original schedule (see subsection 2.3.1). Conclusively, as far as possible, the train's original schedule can be utilized as a baseline to derive the spatiotemporal information of the train during the development of each of its PVSCS.

As a result, the complexity during the development of each PVSCS may be curbed by merging two approaches. First, the two-step heuristic, which foresees to develop each PVSCS by considering an empty network. Second, the right-shift rescheduling heuristic, which foresees to utilize as far as possible the spatiotemporal information of every train's original schedule to develop its PVSCS.

ii) Vehicle-Specific Level

The vehicle-specific level counts with the set of PVSCS for every train generated at the line-specific level as a collection of conflict resolution alternatives. The PVSCS for every train ought to be selected, combined, and ultimately, "fixed" systematically to generate the candidate conflict-free schedules.

Aligned with the overall structure of the approach, a heuristic approach needs to be advanced to manage the selection of the PVSCS for every train so as to assemble a PVSCS combination. Every assembled PVSCS combination would contain one PVSCS for every train in the network, which would provide a framework for the adjustment of schedule and circulation plan of the network that simultaneously addresses the line-specific conflicts. Since the individual PVSCS have been developed considering an empty network, the resulting PVSCS combinations must be subsequently fixed by means of an automatic vehicle-specific CDCR process (see subsection 2.2.3). The fixing of a PVSCS combinations entails resolving all vehicle-specific conflicts until it is conflict-free, as foreseen by the system requirements (see subsection 3.4.2).

Abiding by the requirements in subsection 3.4.2, the combinatorial heuristic in charge of assembling the PVSCS combinations and vehicle-specific CDCR process should be purposefully designed to provide a special handling of the trains queuing near the disrupted section. In this way, the approach ensures that not only a conflict-free schedule can be attained, but also the transition of the network to stable operations is adeptly supported (see subsection 3.4.2).

Furthermore, since the vehicle-specific CDCR process relies on a systematic handling of conflicts based on a predefined bundle of elemental conflict solution alternatives for all four conflict types that must be handled, namely, occupancy, infrastructure availability, circulation and service conflicts (see subsection 3.4.2), different conflict resolution alternatives can be developed. The elemental conflict solution alternatives can be combined to generate a respective set of conflict resolution alternatives for every identified conflict. For the automatic selection of the alternatives and aligned with the requirements of this *Section* (see subsection 3.4.2), an evaluation function would permit to ascertain the best possible solution alternative and in due course, fix the generated PVSCS combinations. To further reinforce the quality of the CDCR process, a 'look-ahead' property must be included in its structure, as discussed in exiting models in subsection 2.2.3. The look-ahead property would enhance the quality of the solutions and further support the automatic fixing process of the PVSCS combination at every step of the CDCR process.

Moreover, as discussed in subsection 2.2.3, the systematic handling of trains end their respective conflicts follows either a synchronous or asynchronous approach. While the information of other types of railway traffic is available to ambiguous extents and the dynamic DRP deployment system must focus on capacity consumption (see subsection 3.4.2), the handling of trains in the dynamic DRP deployment system or any occurring conflicts is to be handled synchronously.

Since every assembled PVSCS combination has the potential of establishing a resulting conflict-free schedule, the fitness of every fixed PVSCS combination must be ascertained. The fitness should be established through an evaluation function, which may or may not be aligned with the one utilized with the CDCR process. The fitness of every assembled PVSCS combinations may also be utilized to further guide the development of new PVSCS combinations, and as a benchmark for terminating the system.

The structure of the overall evaluation function may be arranged in modules, as the ones detailed in subsection 2.2.3. A modular structure allows a flexible configuration of determining variables that must be weighed and normalized so that they can be easily added, removed or compared with one another. The normalization of each of the determining variables entails that each of them has its evaluating structure established from the same point of view (e.g. temporally) and permits to handle any conflict resolution alternative regardless of the conflict type, which is being resolved. As a result, the evaluation can be performed independently for specific purposes. For example, during the vehicle-specific CDCR process to establish the best conflict resolution alternative that can be utilized to solve one specific conflict or to ascertain the fitness of the fixed PVSCS combinations.

Due to the automatic nature of the CDCR processes, it is possible that the resulting conflict-free schedule contains train services that have spatiotemporal misalignments from their original schedule, which are not operationally necessary. The misalignments are induced due to the implementation of specific conflict resolution measures to address any of the handled conflict types at an individual step of the systematic CDCR process, and once all the trains have been handled, and the schedule is conflict-free (i.e. fixed), they become operationally unnecessary. For example, a shift in time appointed to a train at the entrance of a station to solve an occupancy conflict in the switching zone may become unnecessary as one of the conflict partners is later rerouted to a different platform track to solve a circulation conflict. These measures are referred to as “unnecessary” (e.g. unnecessary shift in time). A similar problem has been handled in the model of Chiang et al. (1998) (see subsection 2.2.3).

To uphold the quality and practical relevance of the resulting conflict-free schedule, specific processes are necessary to identify and remove unnecessary measures. While the removal of unnecessary measures can be conducted during the CDCR process at the vehicle-specific level, it would make the fixing process of the PVSCS combinations more complex. As detailed by Chiang et al. (1998), if the removal of unnecessary measures is conducted in parallel to the CDCR process, the removal would require the algorithm to jump back in time to portions of the schedule, which are already conflict-free to remove an unnecessary measure. Thus, the process would inherently interfere with the synchronous process and run the risk to create infinite computation loops (see Chiang et al. 1998). Consequently, the removal of unnecessary measures should be conducted once the PVSCS combinations have been completely fixed.

Ultimately, abiding by the requirements detailed in subsection 3.4.2, special attention must be given to the effectiveness and efficiency in which the system is able to derive the strived solution (i.e. train number and minute-specific conflict-free schedule). For this purpose, the approach that may be chosen to generate the PVSCS combinations and the speed with which the assembled PVSCS combinations can be fixed (i.e. made conflict-free) would influence the amount of handling alternatives that can be assessed for each of the trains in the system. Therefore, to further enhance the efficiency of the system and indirectly its practical relevance, the heuristic approach in charge of the management and assembly of PVSCS companions must be carefully selected. Additionally,

the CDCR process should be able to fix the assembled PVSCS combinations (i.e. make the PVSCS combinations conflict-free) in the fastest way possible. In this regard, it is anticipated that the above-discussed difficulties can be partly addressed by incorporating in the system the simplicity and built-in modelling precision of the enhanced macroscopic modelling technique introduced by Oetting and Griese (2016a, 2016b), which may be limited to fixed-speed models.

3.5.3. Overall Structure of the Approach

Based on the methodology detailed for each of the *Sections* throughout subsection 3.5.2, the overall structure of each of their approaches is derived and discussed in the following subtitles. Within each of the subtitles, a detailed account of the overall structure of the resulting approach for each of this work's *Sections* is provided.

Section 1 – Residual Capacity for Passenger Rerouting

The first *Section* of this work is aligned with the requirements, limitations and general approach established to generate the public transport residual capacity estimation model to be applied for the assessment of DRP transport concepts.

At the outset, the model's overall approach is broken into three fundamental parts.

Initially, based on the literature review (see subsection 2.4), the determining variables with the most relevance for conducting an estimation of the residual capacity are identified, and general assumptions for their handling are proposed. The parameters are identified by distinguishing two general groups, namely, scheduled operational parameters and demand related parameters.

Subsequently, the proposed assumptions are verified by contrasting them with actual information related to public transport capacity utilization. The operational information is gathered from different public transport modes and processed explicitly to verify the assumptions. Ultimately, the verification sets the groundwork to operationalize the residual capacity estimation based on the parameters established in the first part.

Finally, the actual model and its overall structure are introduced. The resulting public transport residual capacity estimation model incorporates in its structure the identified parameters, verified assumptions and is advanced along with the approach discussed in subsection 3.5.2.

Section 2 – Dynamic Deployment of Disruption Programs

Abiding by the second *Section's* methodology, the dynamic DRP deployment system is constituted by specific processes distributed across two operational levels.

Each of the processes detailed in the dynamic DRP deployment system's methodology is to be arranged into a module, thus, deriving a modular structure. Structuring the systems into a modular structure would render the approach to be purposefully adaptable to different railway traffic types (e.g. regional traffic), easier to upgrade and permits the modules to be implemented independently for different purposes.

As a result, the system's overall approach is constituted by nine modules that are structured as depicted in figure 3.1. However, it is likely that further technical and situational heuristics need to be introduced along each of the operational levels in order to fulfill specific tasks.

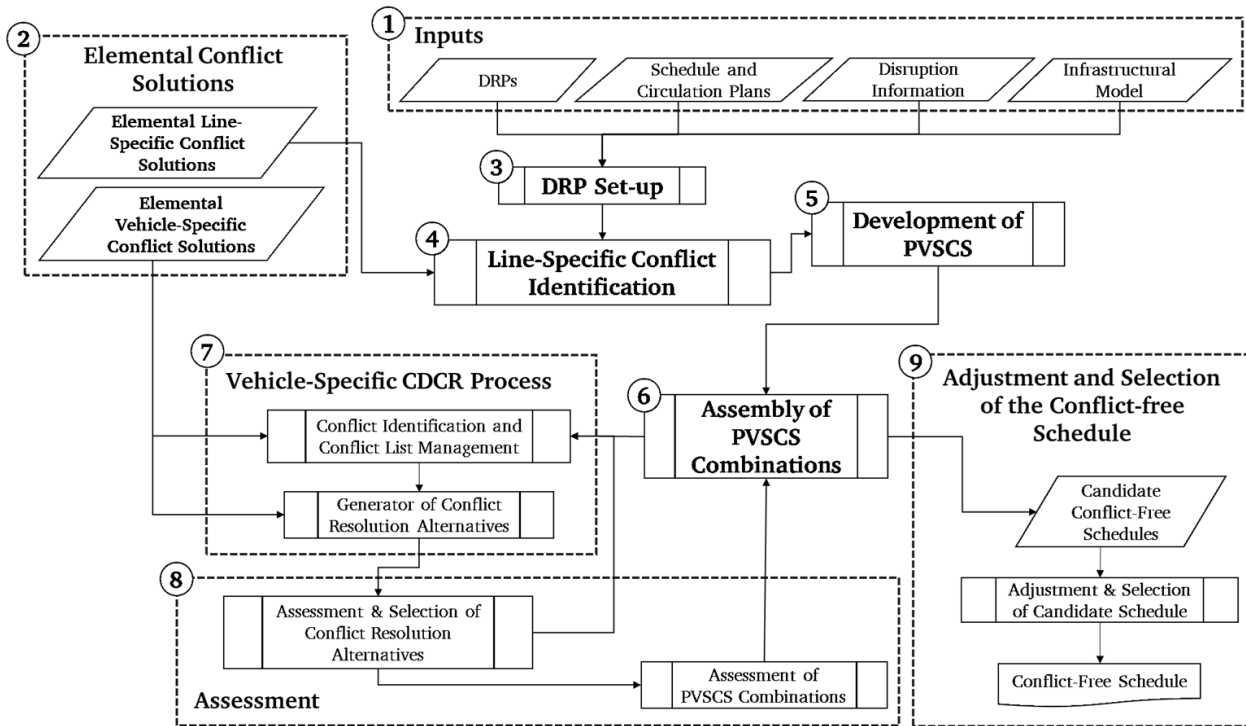

Figure 3.1 Structure of the dynamic DRP deployment system (by author)

The first two modules are connected with both of the system’s operational levels. Module 1 collects and manages the require input information to be utilized within the system. The inputs are accompanied by module 2, which comprises all predefined and ready to use elemental conflict solution alternatives. The alternatives are introduced in bundles for every conflict type handled by the system across both its operational levels.

Subsequently, a series of three consecutive modules constitute the line-specific operational level of the system. The three modules embody the first step in the two-step repairing heuristic approach discussed in subsection 3.5.2. The first module, namely, module 3, entails the set-up of the chosen DRP operating concept on the actual disrupted situation. Later, module 4 supports the identification and classification of the line-specific conflicts across all disrupted railway lines. This allows establishing potential dispatching measures alternatives that can be appointed to each of the line’s trains an address the identified conflicts. Based on the most suitable dispatching measures attained in module 4, module 5 generates a set of operational and technical feasible PVSCS for every train. At this stage, the PVSCS alternatives are developed considering an empty network; thus, they do not consider the interactions between different trains.

Thereafter, a series of three nested modules are in charge of combining, fixing and assessing the already developed PVSCS for every train, while keeping track of the system’s capability to transition to stable operations. The three nested modules are complemented by one last module in charge of adjusting and selecting the best conflict-free schedules. As a result, the four modules constitute the vehicle-specific operational level of the system and the second step in the two-step repairing heuristic.

The first of the three nested modules, namely, module 6, may be regarded as the engine of the approach. Module 6 is in charge of selecting specific elements from each train’s set of PVSCS, and by means of a combinatorial metaheuristic, it assembles the selected PVSCS into combinations.

Module 7 fixes every assembled PVSCS combination to secure they are conflict-free. The assembled PVSCS combinations are fixed with an automatic CDCR process that supports the handling of occupancy, infrastructure availability, circulation and service conflicts.

Thereafter, module 8 is in charge of assessing the conflict resolution alternatives generated in module 7 and includes a 'look-ahead' property, which takes into account follow-up conflicts. The general calculations rely on typical railway operations science methods, such as the application of driving times, occupancy time calculations and minimum headways. The same module is in charge of deriving the fitness of the fixed PVSCS combinations (i.e. conflict-free schedule), which are referred to module 6 to guide the development of further PVSCS combinations and verify the system terminating criteria.

Finally, from the set of candidate conflict-free schedules delivered by module 6, module 9 is in charge of adjusting schedules, and ultimately, selecting the system's proposed solution.

Each of the nine modules depicted in figure 3.1 is briefly detailed and summarized in the following subtitles.

Inputs

Considering the methodology which divides the system into two operational levels, four fundamental inputs are identified as to be particularly necessary to support the processes that have been foreseen within each module that constitutes the system.

First, the DRP operating concept respective to chosen DRP, which has been manually selected to address the specific disruption. Furthermore, an infrastructure model of the investigated railway network that is aligned with the system's requirements and limitations. Furthermore, actual operational information of the network, which adeptly reflects the disrupted operations. Finally, the original schedules and circulation plans of each of the train services from the investigated commuter railway network.

Overall, the first module is in charge of collecting, managing and processing the required input information. The first module handles the information as is required across the subsequent processes in the system.

Elemental Conflict Solutions

The module of elemental conflict solutions is a repository of predefined measures to solve conflicts across both line and vehicle-specific operational levels. As discussed in subsection 3.5.2, at the line-specific level, two conflict types are handled by the system, namely, vehicle availability and reachability conflicts. Furthermore, at the vehicle-specific level, four conflict types are handled by the system, occupancy, infrastructure availability, circulation and service conflicts. The elemental conflict solutions under consideration are briefly introduced in subsection 3.6.2.

Within this module, the elemental conflict solutions are clustered in bundles, constituting ready to use alternatives that can be immediately implemented by the system. The bundles of elemental conflict solution alternatives are established based on current dispatching approaches, existing models as well as manual DRP deployment practices. Every conflict type being handled by the system is appointed with a bundle of elemental conflict solution alternatives. As a result, there are six different bundles within this module.

The first two bundles contain a series of predefined measures that can be utilized to address line-specific conflicts. The manual DRP deployment practices have mainly been reflected in the structuring of these two bundles of measures.

The following four bundles have been established to address the three vehicle-specific conflict types handled by the system. Ultimately, instead of connection conflicts, a bundle of elemental conflict solution alternatives to address service conflicts is also supported in the module.

DRP Set-up

The DRP set-up module, as its names suggest, focuses on the set-up of the chosen DRP that better fits the disrupted situation. As it has been discussed in the system's limitations (see subsection 3.3.2), choosing the best fitting DRP from the set of available DRPs for the network is not within the scope of the system.

Overall, once the DRP has been chosen, its operating concept is set-up following the approach detailed in subsection 2.3.3. As such, the DRP set-up consolidates a linkage between the actual operational circumstances throughout the disrupted network and the line-specific DRP operating concept of every network's affected line. Nonetheless, since the module is based on an existing DRP set-up, the approach is retrofitted so that it is compatible with a dynamic deployment of the DRP operating concept.

With the retrofitted processes, the enhanced DRP set-up is able to provide a much representative overview of both the operational condition of both the network and each of the trains, at the early stages of the disruption-management.

Line-Specific Conflict Identification and Establishment of Potential Solutions Alternatives

Having already set-up the DRP operating concept in the system, the next module endeavours the identification of the two line-specific conflict types. Inspired in existing CDCR approaches (see subsection 2.2.3), the module performs the first diagnosis of the disrupted operations by identifying, classifying and sorting the line-specific conflicts for every affected line in the network.

The two conflicts types identified at this level are: vehicle availability and reachability conflicts, which reflect the operating condition of a line immediately after the occurrence of the disruption. This module is targeted at establishing the best fitting line-specific elemental conflict solutions that can be applied to any of the trains that provide service to each of the affected lines.

Development of PVSCS

The PVSCS development module is in charge of developing different PVSCS for every train in the network, ultimately, instituting the respective PVSCS sets. Overall, the module incorporates the already established potential conflict solution alternatives corresponding to address the train's line-specific conflicts and utilizing a right-shift rescheduling approach it develops multiple PVSCS for the train. Before they are introduced in the train's PVSCS set, the developed PVSCS are assessed to corroborate their technical and operational feasibility.

Different PVSCS for a train are developed through a systematic merger of one of the potential conflict solution alternatives, a specific route throughout the network that is complemented by the respective temporal information (e.g. arrival, departure times to and from nodes) and a set of alternative transition train services to adjust the circulation plan. These three elements, guided by a right-shift rescheduling approach while considering an empty network, allow deriving one

particular PVSCS for a given train. The resulting PVSCS constitutes a conflict resolution alternative at the line-specific level that contains explicit spatiotemporal information and a set of transition train services. Additionally, the technical and operational feasibility of every resulting PVSCS is to be verified over similar grounds as in Brauner (2019). As a result, only the most relevant PVSCS are introduced in the resulting PVSCS set of a train.

Assembly the PVSCS Combinations

Incorporating the PVSCS sets for all trains established in the previous module, the PVSCS combination assembly module is in charge of the selection, assemblage, and subsequent management of the PVSCS combinations. The module selects specific PVSCS from the PVSCS sets of every train circulating in the network to assemble the PVSCS combinations, which are to be fixed in subsequent modules.

The module is based on combinatorial metaheuristic algorithms, which allow endeavouring an efficient and effective selection, assemblage and management of the different PVSCS combinations. Since the module is in charge of managing the development of the PVSCS combinations, it must be able to communicate with the assessment module. The module utilizes the communicated information to explore the search space in such a way that the specific objectives of the system can be supported, namely, establish a conflict-free schedule and transition of the network to stable operations.

Vehicle-Specific CDCR Process

The fixing of PVSCS combinations is conducted with an automatic CDCR process, similar to the one advanced in Oetting et al. (2011), and Oetting et al. (2013) for occupancy conflicts. The existing approaches are expanded to support the handling of infrastructure availability, circulation and service conflicts.

The module supports the identification of vehicle-specific conflicts, the synchronous sorting of conflicts in a conflict list, the development of conflict resolution alternatives and communication with the assessment module to update the conflict list as conflict resolutions are selected. Furthermore, the module also supports the required “look-ahead” capability of the system and provides a framework to identify follow-up conflicts. Each of the process conducted in the module is aligned to enhance the handling of queuing trains in the critical area, particularly in the vicinity of the LtFTS.

Assessment of the Conflict Resolution Alternatives and the Fixed (i.e. Conflict-Free) PVSCS Combinations

The assessment module incorporates the conflict resolution alternatives generated in the previous module and evaluates the alternatives utilizing an evaluation function. The evaluation function is established following a similar structure as the one introduced in Oetting et al. (2013).

The evaluation function is constituted as a modular structure with specific determining variables that are weighted and additively connected with each other.

Furthermore, once the PVSCS combinations are made conflict-free (i.e. fixed), the evaluation function is in charge of establishing its overall fitness, which is to be communicated to the PVSCS development module.

Adjustment and Selection of the Conflict-free Schedule

Once the termination criteria in the exploration engine (i.e. PVSCS development module) has been fulfilled, the resulting set of candidate conflict-free schedules is communicated to the adjustment and selection module.

The adjustment and selection module is in charge of adjusting the conflict-free schedules (i.e. fixed PVSCS combinations;) namely, removing the unnecessary measures and adjusting their fitness. The module performs the adjustment of the conflict-free schedules based on the approach introduced in Chiang et al. (1998) and expanding it to support a wider range of unnecessary measures.

Finally, with the conflict-free schedules and their adjusted fitness, the module is in charge of selecting the conflict-free schedule that better fits with the system's requirements and this *Section's* specific objectives.

3.6. Basic Terminologies

This subsection introduces basic terminologies that are utilized within each of the *Sections* advanced in this work. The terminologies are extracted from the discussed literature and their utilization in current practice.

The outline of basic terminologies is later complemented by definitions introduced to support the development of each of the *Sections* of this work. The definitions are introduced so as to support the lack of appropriate terminology within available literature and to refer to any new frameworks contributed throughout this work.

3.6.1. Section 1 – Residual Capacity for Passenger Rerouting

Spatial Terminology

Air Distance

The air distance is understood as the idealized and immediate (i.e. lineal) measured physical distance between two points in a map. The term is utilized to highlight the fact that no physical obstacles or detours are considered when measuring the distance between the considered locations.

Detour Factor

The detour factor is a parameter utilized to account for the actual distance between two points in an urban environment when only the air distance is available. The detour factor allows considering obstacles that need to be sorted between origin and destination points. The detour factor is expressed as a function of the measured air distance, as explained by Walther (1973).

Temporal Terminology

Temporal Categories

As discussed in subsection 2.4.4, commuting flows or congestion patterns are said to fluctuate throughout the day. The regularity with which the aforementioned fluctuations take place in a specific network can be categorized in different time windows, as peak or off-peak hours.

The temporal categories refer to the time of day in which a specific strength in the commuting flow (i.e. transport demand) can be recognized. As it has been explained in subsection 2.4.4, in German transport and traffic planning three fundamental temporal categories are identified, namely “Hauptverkehrszeit” (HVZ), “Normalverkehrszeit” (NVZ) and “Schwachverkehrszeit” (SVZ) (see Schnieder 2015).

The HVZ denotes the time on weekdays with the strongest transport demand in a specific network (e.g. public transport network). The HVZ is also referred to as the peak-hour and may take place more than once per weekday (Lopez et al. 2017). The NVZ denotes the time of day with a somewhat constant demand in the network and in most cases, takes place between peak-hours. Finally, the SVZ indicates the time of day with expected low demand in the network. Within public transport networks and depending on the local mobility culture, the SVZ tends to take place around the beginning and or end of operations as well as during weekends.

Public Transport Capacity Related Terminology

Scheduled Capacity

The scheduled capacity refers to the planned passenger transporting capability of a public transport line, which results essentially from the frequency and the overall size (i.e. passenger hauling capacity) of the utilized vehicles (Dorbritz and Anderhub 2007). The passenger hauling capabilities takes into consideration both sitting and standing places of a public transport vehicle.

Regardless of the studied mean of public transport, the scheduled capacity of a public transport line is measured in passengers/hour and can be adjusted throughout the day to better fit with the changes in demand (Schnieder 2015).

Utilized Capacity

The utilized capacity refers to the quantity of scheduled capacity of a public transport line being utilized by passengers as a result of the existing demand. For capacity planning purposes, establishing the actual demand within a public transport network and its respective shifts throughout the day entails an analysis of actual user behaviour information (Schnieder 2015, Dorbritz and Anderhub 2007).

Occupancy Rate (OR)

The occupancy rate refers to the overall share of the scheduled capacity of a public transport line that is being utilized (Crespo and Oetting 2018). Since the occupancy rate relates both scheduled and utilized capacities is inherently dependent on the parameters influencing passenger’s travel behaviour and the scheduling of public transport services.

3.6.2. Section 2 – Dynamic Deployment of Disruption Programs

Spatial Terminology

Infrastructural Element

An infrastructure element stands for any infrastructural component that supports the movement of a train throughout the physical railway network (e.g. switching zones, platform tracks, or tracks).

As discussed in subsection 2.2.2, infrastructural elements are abstracted by means of a modelling technique. Consequently, the term infrastructural component may also refer to the abstract representation of the elements, as per the granularity supported by the utilized modelling technique. For example, in the case of a mesoscopic infrastructure model, the term may refer to platform track and or switching zones within nodes or tracks represented by a link connecting two nodes.

Network

The term network refers to the set of lines that are planned in order to satisfy the demand that exists for railway transport (Acuña-Agost 2010). Each of the lines that constitute the network is planned in such a way that it seeks to minimize operating costs while maximizing the overall share of passengers with direct connections (Acuña-Agost 2010).

Trunk Line

The trunk line, in German, referred to as “Stammstrecke”, is a section of the network where most, if not all lines, share a portion of the track (Oetting and Chu 2013). Due to the overlapping of routes of different lines, the trunk line is characterized as the network’s section with the minimum service intervals. The trunk line is of particular relevance, as it is the most travelled section of the network; thus, a bottleneck prone to the occurrence of disruptions. Oetting and Chu explain: “[...] trunk lines form the bottlenecks of the systems as the entire network is subject to delays if there is a disruption in this section.” (2013, p.8).

Core Area of the Network

The core area of the network is the portion of the commuter railway network that concentrates the significant share of the operations detailed in its operating program. The core area includes the network’s trunk line and in some cases, other essential sections.

Figure 3.2 provides an actual example, depicting the core area of the S-Bahn network of the city of Frankfurt am Main. Figure 3.2 details the different stations which constitute the core area. In the figure, the trunk line can be identified between the central railway station (i.e. FFT – see figure 3.2) and the junction “Schlachthof” (i.e. FSHF – see Figure 3.2).

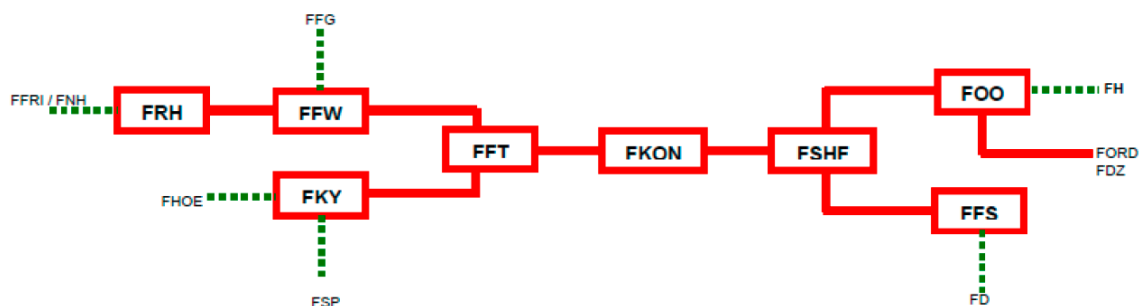

Figure 3.2 Example of the core area of a commuter railway network (Kremer und Rink 2016)

Given the metropolitan nature of the commuter railway networks, the core area is most likely located in the city center, and it is either the source or objective of most passenger trips being serviced by the network.

End/Beginning Station

End or beginning stations refer to stations specified in the schedule in which a train service either terminates or begins its service. The end and beginning station of two consecutive train services are generally the same. Potthoff et al. explain: “A service trip (commonly known as train) is operated on a line, where a line is specified by a start and an end station and a number of intermediate stops.” (2010, p.494).

It is possible that a train is scheduled to drive from an end station to a station where it is supposed to begin its subsequent train service. The drive between end and beginning stations is performed with an empty train and referred to as a dead-headed trip (Wagenaar et al. 2017).

Line Cycle Variants

The line cycle variants refer to the spatial variations in a line’s route between successive train services (see subsection 2.2.1). The spatial variations in a line’s route entail the introduction, removal or substitution of one or more stations serviced by the line’s scheduled train services, which may or may not involve end/beginning stations (Cao 2017). In due course, the variations in the line’s route affect the computation of the vehicle cycle times (see subsection 2.2.1).

Turning Station

A turning station refers to a station in which the change of a train’s driving direction (i.e. turning) is technically feasible. The technical feasibility denotes the availability of the necessary infrastructural elements in the station (e.g. switches, signals, platform tracks) to support a train’s ability to change its driving direction. End stations are the best example for regular turning stations, as it is relatively common that turns between consecutive train services need to be scheduled at these stations (Chu 2014).

DRP Turning Station

The term DRP turning station has been introduced in the work of Chu et al. (2012) and refers to a station in which the DRP operating concept foresees the systematic turning of trains during the disruption. DRP turning stations are appointed line-specific, the closest possible to the disrupted section to uphold as much of a line’s regular service as operationally possible (Chu 2014).

As detailed in table 2.4, a maximum of two DRP turning stations can be appointed for every line on each side of the disrupted section. DRP turning stations may or may not be appointed to stations that are initially included in the line’s original route. If a DRP turning station is outside of the line’s original route, the strategy is recognized as a: deviation with replacement (see table 2.4). Finally, DRP turning stations may be considered end stations for all Green trains until the DRP has not been withdrawn.

Last technically feasible turning station (LtfTS)

The last technically feasible turning stations (LtfTS) refers to all reachable turning stations the closest to the disrupted section. The LtfTS provides trains with the last opportunity to turn before reaching the disrupted section. During a complete blockage, any train that finds itself beyond the LtfTS is either the cause or has been irreversibly affected by the disruption (Oetting and Chu 2013). A LtfTS may also be recognized as a DRP turning station by the chosen DRP operating concept. Additionally, during a disruption that generated a complete blockage of a section, dividing the network into two different sides, the LtfTS may also be considered the end station for all train

services that are not able to follow the DRP operating concept of their lines and are scheduled to drive past the disrupted section during a complete blockage.

Deviation Points

Deviation points are referred to as specific locations in the network in which a train can deviate away from its scheduled route (Brauner 2019). It must be noted that deviations foresee the complete change of a train's driving path and not a simple change in its route, as it would be, for example, the train's rerouting through a given node. Deviation points are also appointed in the DRP operating concept, as detailed in table 2.4.

Relative-Time Measuring Points

As discussed in subsection 2.2.3, during operations, a train's relative-time is projected and measured across a series of points throughout its route. Measuring points register the arrival, departure, or drive-through time of a given train (DB Netz RIL-420, 2017). As explained in D'Ariano (2008), relevant measuring points may be, for example, the last block section before the end of a line or dispatching area, a junction, or a platform track.

Actual Location of the Train

A train's actual location refers to recognizing its position within the infrastructure at a specific moment in time. It is of particular importance for the dynamic DRP deployment system, as it allows pinpointing the location of all trains circulating in the network at the moment the system is being implemented.

Parking Locations

Parking locations refer to any railway facility in which a train can be shutdown. Parking locations are located all around the network, the most relevant being: shunting yards, deposits, shunting tracks, platform tracks in stations, and depending on the context, even sidings in which vehicles are routinely shutdown (Menius and Mathhews 2017). It is also usual that these locations are utilized for further shunting operations in preparation for the scheduled operations, namely, the formation of vehicle compositions, cleaning, refuelling, etc. (Menius and Mathhews 2017). Additionally, these locations have a limit as explained by Lusby et al.: "[...] *parking space is limited. This means that only a certain total length of units can stay parked in depots at any point in time.*" (2017, p.233).

In the case of passenger trains, since multiple train services end and start their operations at important railway stations, their parking locations are typically shunting tracks located within or in the vicinity of these locations (Menius and Mathhews 2017). However, as parking locations can be appointed at any available track within a station, their capability to handle and host passengers must also be considered. Such verification is imperative for the dynamic DRP deployment system, as it allows corroborating the need for additional shunting movements between platform tracks and parking locations to be scheduled.

Temporal Terminology

Time of Day (HVZ; NVZ; SVZ)

Refer to: *Temporal Categories*, detailed in subsection 3.6.1.

Estimated Disruption Length

The estimated disruption length refers to the overall duration of the disruption. In the context of planned disruption approaches, the disruption length is the time between the disruption occurrence until the network is able to return to normal operations (see figure 2.5).

However, for the dynamic DRP deployment system, the disruption length, which must be fed into the system, refers to the remaining time between the moment the DRP has been declared (i.e. end of the investigation phase – see figure 2.5) until the network returns to normal operations. This information is of critical importance, as explained by Ghaemi et al.: “An essential piece of information that has a crucial role in their decisions regarding the traffic is the predicted disruption length. Since any change in the timetable is costly, if the predicted length is shorter than a specific threshold then they might decide not to implement major changes to the timetable.” (2018, p.103).

Minimum Transition Time

The minimum transition time refers to the smallest operational time required to complete the transition of a vehicle or vehicle composition between two subsequent train services. Three fundamental transition types can be included in the circulation plan of a vehicle or vehicle composition, namely, turning, coupling, and decoupling of trains (Chu et al. 2012).

Minimum values for each of the transition types are detailed within network guidelines, for example, in the German infrastructure manager guideline DB Netz RIL-402 (2008). The guideline DB Netz RIL-402 (2008) establishes benchmark values for minimum transition times to be utilized for planning purposes. The proposed values take into consideration the minimum time required to fulfill all operational and practical procedures as are necessary for the respective transitions.

- As a minimum turning time, the guideline DB Netz RIL-402 (2008) foresees a minimum benchmark value of 6 minutes. Chu (2014) provides much more detailed insight and underscores the role of a train’s length and the availability of one or two drivers. The recommended minimum turning times provided in Chu (2014) are for long trains and equate to 2 minutes for two drivers.
- As minimum coupling time for trains with automatic coupling, the guideline DB Netz RIL-402 (2008) introduces a minimum benchmark value equal to 5 minutes. The minimum coupling time is to be accounted for from the home signal to the station of the last vehicle to be coupled until the departure of the resulting vehicle composition.
- As minimum decoupling time for a train with automatic coupling, the guideline DB Netz RIL-402 (2008) foresees a minimum benchmark value equal to 3 minutes. The minimum decoupling time is to be accounted for from the arrival of the vehicle composition to the station until the departure of the first resulting train service.

Minimum Communication Time

The minimum communication time refers to the time necessary to transmit any dispatching decision or order from the dispatcher to the respective staff member (e.g. driver, signallers, train station personnel, etc.) (Stelzer 2016).

The communication time during disrupted stations has been discussed in Chu (2014), where the author explains that the communication time acquires common values between one to four

minutes. For the dynamic DRP deployment system, a benchmark value at the upper limit of 4 minutes, as the minimum communication time, is recommended.

Minimum Communication Time to Passengers

The minimum communication time to passengers refers to the time necessary to transmit the relevant information (e.g. platform track changes, cancellations, delays, etc.) to the passengers across the respective stations.

The communication may take place through a broad range of channels and deliver the information with different detail (Boltze and Dinter 1996). The degree of detail that is required remains as a function of the changes being implemented across the train services (Stelzer 2016).

The minimum communication time to passengers must be accounted for from the moment the dispatching decision has been taken. Since the information must be transmitted between different actors (e.g. dispatchers, stations personnel, etc.), the recommended benchmark value must be at least as high as the minimum communication time (see subsection 3.6.2). Therefore, it is recommended for the dynamic DRP deployment system to assume 6 minutes as the minimum benchmark value for the communication time to passengers.

Minimum Platform Exchange Time for Passengers

During the adjustment of the schedule, it might be necessary to change the platform track of multiple trains, aspect which has an immediate impact on its users. Consequently, the rescheduling process may be able to consider the impact on its users by supporting a minimum time, which is required for passengers to exchange the platforms (Stelzer 2016).

The minimum platform exchange time is a highly context-specific feature, which can be expressed as a function of the platform lengths, the distances between platforms, and among others, the need to utilize elevators or stairs (Stelzer 2016). Furthermore, in large and busy stations, crowding would also influence the time required to complete the exchange. During the planning process, the aforementioned aspects are considered for the planning of connections between train services. The values utilized during schedule construction may also be utilized for the dynamic DRP deployment system.

Minimum Time for Emptying a Train

For trains being removed from the network towards a parking location, the driver must make sure that all passengers have alighted from the train. Therefore, a minimum time for emptying the train must be taken into consideration. Brauner explains: *“The occupancy times of the tracks where this measure is pursued consist of preparation times for the continuation of the run with and without changing the direction. They include, among other things, a complete alighting of passengers and an additional train inspection.”* (2019, p.24).

Brauner (2019) details three specific times to be considered for the emptying process. Initially, it is necessary to account for the time required until all passengers have alighted from the train. Subsequently, the driver must physically check if the train is effectively empty. Finally, the time until the driver has returned to its driving cabin must also be accounted for. Nonetheless, the train may also require a change of driving direction (i.e. turning), a task which can be fulfilled simultaneously with the emptying of the train (Brauner 2019). As a result, the minimum time for emptying the train observes both a minimum time with a change in the train’s driving direction

and one without. For commuter railway vehicles (i.e. considering the length of the vehicle and the walking speed of the only driver) a minimum time for emptying the train equal to 12.5 minutes without changing the driving direction, and 10.8 minutes with a change of driving direction, may be implemented. The first value is higher as the driver must return to its original cabin.

Scheduled Arrival/Departure/Drive-Through Times

The scheduled arrival, departure, or drive-through time refers to the time at which a train should arrive, depart, or drive-through a measuring point according to its schedule (DB Netz RIL 420, 2017).

Relative-Time

Relative time is the temporal difference between the scheduled and the actual time in which a train is registered at a measuring point (DB Netz RIL-420 2017). Therefore, the relative time is specific for every measuring point along a train's route that is still to be travelled.

Projected Arrival/Departure/Drive-Through Times

The projected arrival, departure, or drive-through times are calculated on the basis of the current relative-time of a train throughout all measuring points along its route that is still to be travelled, and if applicable, considering any available journey or stopping time reserves. The projected arrival, departure, or drive-through times are calculated by the control system for all remaining measuring points and observing the train's driving dynamics (DB Netz-420 2017).

Furthermore, for the calculation of the projected arrival, departure, or drive-through times, any dispatching measures being implemented must also be considered (DB Netz RIL-420 2017).

Projected Relative-time Change

The projected relative-time of a train is ascertained from the difference between the projected time and the scheduled arrival, departure, or drive-through times throughout all measuring points along a train's route still to be travelled (DB Netz RIL-420 2017). The projected relative-time at stopping positions must be verified for both arrival as well as departure times and considering any dispatching measures being (DB Netz RIL-420 2017).

Expected Relative-time Change

The expected relative-time change originates from the difference between a train's projected relative-time before the implementation of a dispatching measure (i.e. conflict resolution) and the projected relative-time after the implementation of the dispatching measure. The outcome may be a reduction or increase in the train's overall delay.

On-Time Trains

On-time trains are all trains that can be considered to be punctual. The consideration is made by including a threshold limit in which trains, although they might carry a certain amount of delay, can still be referred to as being punctual (Hansen and Pachl 2014). The threshold limit is set context-specific; for example, in Germany, the value is 6 minutes (Hansen and Pachl 2014).

Initial Delay

Initial delays refer to the delay recorded at the entrance of the train to the dispatching area under consideration (Hansen and Pachl, 2014). However, in the specific case of the dynamic DRP deployment system, the initial delay is recognized as the delay, which is recorded for every train up to the moment the dynamic DRP deployment system is implemented.

Negative Turn

A negative turn refers to appointing a train a change of driving direction and a transition train service in the opposite direction that would ensure a delayed start after its turn. Figure 3.3 depicts a generic example of a negative turn appointed to a train at the LtTfS. In the example, train service S35535 is scheduled to turn at station A and appointed as transition train service the train number S35536. After considering a minimum turning time at the station, the train is set to start with a delay.

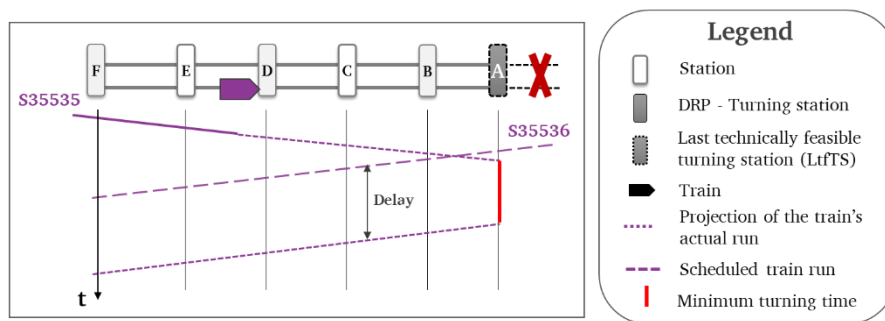

Figure 3.3 Example of a negative turn (by author)

From figure 3.3, it is possible to appreciate the negative turn as a function of not only the transition train service that is appointed to a train but also the turning station which is chosen. Negative turns are utilized in Brauner (2019), during the development of DRPs to verify the feasibility of their operating concepts.

Positive Turn

A positive turn refers to appointing a train a change of driving direction and a transition train service in the opposite direction that would ensure its punctual start after its turn. Figure 3.4 depicts a generic example of a positive turn appointed to a train at the LtTfS. In the example, train service S35535 is appointed as transition train service the train number S35536 and it is scheduled to turn at station A. The train is set to start punctually after a minimum turning time is considered. An additional waiting time at the station until its scheduled departure, is also required.

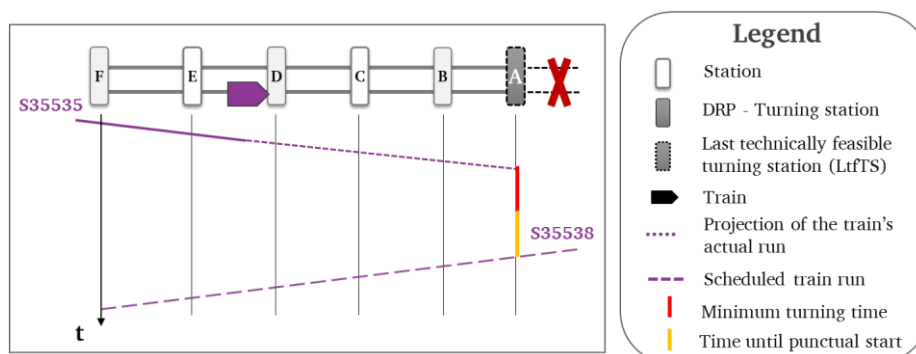

Figure 3.4 Example of a positive turn (by author)

Unnecessary Waiting Times

Unnecessary waiting times refer to temporal shifts that have been utilized during an automatic CDCR process to address a given conflict, and due to the development of the operating circumstances (e.g. resolution of further conflicts), the measure is no longer necessary (i.e. unnecessary) (Chiang et al. 1998).

Unnecessary temporal shifts are removed from a conflict-free schedule to enhance the quality of the solution. However, once removed, they may induce follow-up conflicts that still need to be addressed (Chiang et al. 1998). As a result, a holistic removal of unnecessary temporal shifts entails accounting for a trade-off between their total or partial elimination and the introduction of new measures required for the resolution of any induced follow-up conflicts.

Cycle Time

The cycle time refers to: “*the total time between two successive departures of the same train at the same station in the same direction*”, as displayed in figure 2.2 (Hansen and Pachl, 2014, p. 43).

Service Interval

As part of a cyclic schedule, it is possible to recognize for a given line operating in the railway network a “*fixed scheduled time interval between trains*” (Hansen and Pachl, 2014, p. 43). The fixed interval embodies the temporal timespan between the arrival at the same station of two successive train services of the same line and with the same driving direction.

In the context of this work, the “*fixed scheduled time interval between trains*” is referred to as the: service interval. The service interval is specific for every line in the commuter railway network, and it can fluctuate throughout the day to cope with passenger demand.

Service Interval Reinforcement

The service interval reinforcement refers to additional train services that are included in a line’s schedule within a particular time window. The service interval reinforcements reduce the service interval of a line to enhance the service quality, for example, during peak-hours (i.e. HVZ). Typically, the train services working as service interval reinforcement are the first ones to be removed in case of a disrupted situation of the railway network (Chu 2014).

Scheduling Terminology

Train Service

A train service refers to the single planned movement of a train in the network and constitutes the basic components of the operating program (see subsection 2.2.1). Train services contain essential information regarding the train movement they represent. Cao (2017) summarizes the information contained within a train service in:

- beginning and end stations (i.e. origin-destination pair),
- routes and stopping patterns,
- configuration characteristics and dynamic behaviour of the model train, vehicle, or vehicle composition to be appointed (e.g. train length, acceleration and deceleration patterns, ect.),
- exact blocking times, arrival, departure, and drive-through times across the route,

- recovery times and dwelling time reserves.

Schedule

The schedule comprises all planned train services for a given network or portion of the network. The schedule is planned with months and even years of anticipation, ensuring that all train services can operate reliably (Hansen and Pachl 2014). Therefore, the schedule includes not only all train services but their operating order, their timing at junctions, switching zones, as well as platform tracks, and built-in buffer times to avoid delay propagation (D’Ariano 2008, Hansen and Pachl 2014).

Schedules are particularly planned to be robust, which allows them to cope with minor perturbations within real-time operations. However, no schedule can deal with the occurrence of significant delays, or the blocking an entire section (D’Ariano 2008). Thus, the adjustment of the schedule is indispensable during disruptions.

Circulation Plan

The circulation plan comprises information regarding the transition of vehicles and vehicle compositions between the different train services as well as information regarding the type of the scheduled transition (Nielsen et al. 2012). Depending on the network, there are, in general, three basic types of transitions between train services, namely, turning, coupling, and decoupling (DB Netz RIL-402 2008).

The circulation plan is closely connected to the schedule as the transition of the vehicles between train services must be in line with the planned operations (Nielsen et al. 2012). Thus, if there are any adjustments performed in the schedule or changes in the number of vehicles available, it is almost certain that the circulation plan needs to be adjusted accordingly (Budai et al. 2010).

Lines

The term line refers to a route along the railway infrastructure connecting two end stations. A line is appointed to a series of train services (Acuña-Agost 2010). The train services service the route along the line with a given frequency or a pre-established service interval (Acuña-Agost 2010).

Corresponding Lines

Corresponding lines refer to lines that can exchange vehicles or vehicle compositions between their scheduled train services during the adjustment of the schedule (Nakamura et al. 2011). Corresponding lines generally belong to one corresponding group at a time (Nakamura et al. 2011). Figure 3.5 provides a general example of the layout of different corresponding lines.

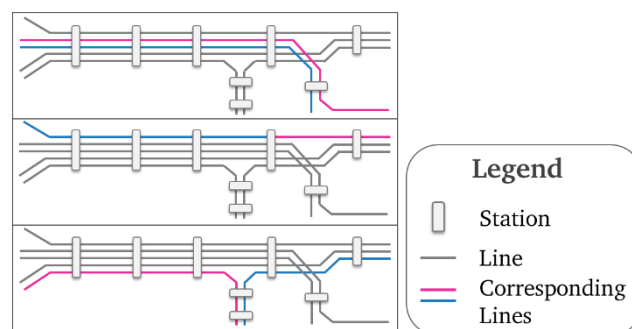

Figure 3.5 Example of corresponding lines (Stemer 2018, modified by author)

Corresponding lines are important for the adjustment of the schedule and circulation plans, as they widen the handling possibilities to deal with the disrupted operations, and ultimately, support in the effort of transitioning the network towards stable operations.

Conflict-free Schedules

Conflict-free schedules refer to a schedule that does not contain any remaining conflicts, considering all four fundamental conflict types that have been discussed in subsection 2.2.3, namely, occupancy, infrastructure availability, circulation, and connection conflicts (Oetting et al. 2011).

Operational Handling

Vehicle

In the context of commuter railway operations, vehicles are generally modular units with the traction unit attached to a series of articulated wagons, and seldom, a combination of an independent traction unit and individual wagons (Schnieder 2015). Therefore, in the context of this work, a vehicle refers to one single self-propelled rolling stock unit that is independent by itself and can not be decoupled (Ben-Khedher et al. 1998).

Vehicle Composition

Vehicle compositions are arranged through the coupling and decoupling of single-vehicle units (Budai et al. 2010). The formation of vehicle compositions may be done during operations through the scheduled coupling or decoupling of train services, or as a result of shunting movements performed prior to the execution of specific train services (Nielsen et al. 2012). The resulting vehicle composition appointed to a train service may be regarded as a train.

The order of each vehicle in the composition may or may not be considered to be important for the management of the operations. For example, restricting the order of vehicles in a composition may take place during the decoupling of a train at specific stations and where passengers are routinely directed to board a specific vehicle(s) in the composition (Budai et al. 2010).

Vehicles with Service Availability

Vehicle compositions with service availability refer to all vehicles in the different parking locations that can be immediately appointed to a specific train service, thus, introduced in the network. Overall, vehicles are considered to be service available if they fulfill the technical, operational and transport conditions required to be introduced in the network.

In Germany, a vehicle can be introduced in the network if it has an “acceptance” as per Article 32 of the “Eisenbahn-Bau- und Betriebsordnung” (DB Netz 2019). However, for the specific utilization of accepted vehicles, the technical conditions established by the German infrastructure manager must be fulfilled (DB Netz 2019). The technical conditions are detailed in the “Technische Netzzugangsbedingungen”, which provide a detailed description of the underlying technical conditions (e.g. breaks, pantographs, etc.) each vehicle must fulfill before it is introduced in the network (DB Netz 2019).

Furthermore, the operational conditions for the introduction of a train in the network are specified in the third section of guideline RIL-438, which has been established by the German infrastructure manager (DB Netz) in cooperation with the association of German transport companies (VDV) (DB

Netz RIL-438 2018). The operational conditions include, among others, ensuring: the availability of the necessary crew to operate the train service as specified in the schedule, abiding by the maximum train length, etc.

Finally, transport conditions are context-specific and safeguard that the train being introduced in the network is aligned with existing passenger comfort standards. Therefore, depending on the train service, which is to be appointed to the vehicle or vehicle composition, aspects like seating availability or the overall passenger hauling capability of the vehicle compositions play a critical role. Further transport conditions, for example, providing air-conditioned or heated wagons to accommodate passengers, must also be considered. Nonetheless, while transport conditions are important for upholding the quality of service, they are not critical for the actual operation of the train in the network and can be potentially overlooked during disrupted operations.

Vehicle Duties

Vehicle duties refer directly to the train services, which are appointed in the circulation plan of a vehicle or vehicle composition (Budai et al. 2010). Budai et al. explain: “Here a duty is the workload of a single train unit on a single day. It is a chain of tasks where a task is characterized by a trip and by the position of the train unit in the train composition of this trip [...]” (2010, p.283). A vehicle is said to have finalized its duties once there are no more train services detailed in its circulation plan.

Vehicle Inventory

The vehicle inventory refers to an overall account of the vehicle and vehicle compositions that have finalized their duties at a certain station at the moment the inventory is being conducted (Nielsen et al. 2012). The vehicle inventory of a certain station can be performed to recognize either an overall amount of vehicles or assembled vehicle compositions (Budai et al. 2010).

End-of-day Vehicle Inventory

The end-of-day vehicle inventory, also referred to as the end-of-day vehicle balance, links the vehicle inventory of a station (i.e. accounted vehicles) with the circulation plan of the next day (Nielsen et al. 2012). In some cases, the inventory is merely based on the number of vehicle units that must be available at the station to support the following day’s circulation plan. In other cases, it is aligned with crew schedules and other tasks (e.g. cleaning). Nonetheless, the inventory accounts for a precise set of vehicles that must finalize their duties at a specific location in the network.

End-of-day Imbalance

The end-of-day imbalance refers to the verified discrepancy between the actual end-of-day vehicle inventory and the planned end-of-day vehicle inventory (e.g. next day’s circulation plan) at a particular station (Budai et al. 2010). All leftover or missing vehicles accounted for by contrasting the end-of-day inventories at the respective stations are regarded as to induce an end-of-day imbalance.

The end-of-day imbalance can be addressed by scheduling additional shunting movements for specific vehicles or vehicle compositions at night or the following day. In the last instance, train services may be cancelled if the imbalance was not resolved. However, this is only conducted if every other alternative has failed (Nielsen et al. 2012).

Shunting Movements

Shunting movements refer to any train movement that needs to be carried for: establishing vehicle compositions, moving trains from one position or track to another, or any other operation which has no direct service objective (Hansen and Pachl 2014). Depending on the context, shunting movements may, or may not be supported in the schedule (Acuña-Agost 2010).

Train Number

The train number refers to the numeric identifier of a train service, which is introduced in the dispatching or monitoring system (DB Netz RIL-420 2017). The train number remains as the primary identification attribute of a train, which permits tracking its status during real-time operations. The train number makes a direct connection to the information of the specific train service, including the circulation plan of its appointed vehicle or vehicle composition (DB Netz RIL-420 2017).

Train numbers are instituted context-specific, according to operational rules. In most cases, train numbers are complemented with abbreviations to identify the type of train service (e.g. “S-12345” for an S-Bahn train service) (DB Netz RIL-420 2017).

Special Train Number

In the context of commuter railway operations, special train numbers refer to train numbers that are utilized only to address extraordinary dispatching circumstances (i.e. disruptions).

For example, if a DRP operating concept appoints two DRP turning stations, the line is effectively divided into two sides. The availability of special train numbers allows different vehicles or vehicle compositions to be assigned to the same scheduled train service on opposite sides of the divided line.

Furthermore, special train numbers can also be utilized to schedule alternative train services. Alternative train services are generated to address additional operational complications that might occur during disruptions, for example, trains located in the vicinity of the disrupted section (e.g. LtfTS) that must wait idly until their scheduled departure time after a turn (i.e. positive turn) (Chu and Oetting, 2013). Alternative train services may be generated to evacuate these trains towards another station in which they are able to wait for their scheduled departure time without compromising the transition to stable operations.

Model Trains

Model trains refer to the standardization of train services into general groups (i.e. model trains) based on the similarity of their characteristics (e.g. similar vehicle compositions, routes, etc.) (Vakhtel 2002). The utilization of model trains has significant advantages as it allows to reduce the dimension of the input data and much more effective and efficient handling of the planning or monitoring of the railway operations (Vakhtel 2002).

The establishment of model trains has been discussed in subsection 2.2.1, where an example supported by an infrastructure modelling technique is also provided.

Stable Operations within a DRP

A DRP is said to have reached stability once all trains find themselves on their line-specific pre-defined routes, and the pre-defined number of trains circulates in the system reliably without accumulating any delay (i.e. with the punctuality of regular operations) (Oetting and Chu 2013, Brauner 2019). The period between the disruption has taken place until the DRP has reached stability is regarded as the “chaotic” phase (see figure 2.5).

Train Conflicts – Vehicle-Specific

Occupancy Conflicts

Overall, occupancy conflicts take place if a train is not able to temporally or spatially follow its schedule, as this would lead to a simultaneous occupation of the same infrastructural element by one or more trains (Neuber 2017, p.205). A differentiation of occupancy conflicts introduced in Oetting et al. (2011), the authors distinguish single and multi over-occupation conflicts. A single multi over-occupation conflict refers to the simultaneous occupation of an infrastructural element by up to two trains. A multi over-occupation conflict refers to the simultaneous occupation of an infrastructural element by more than two trains (Oetting et al. 2011).

Infrastructure Availability Conflicts

Infrastructure availability conflicts take place once trains are scheduled to utilize an infrastructural element that is not accessible or drivable (Pferdmenges and Schaefer 1995). Infrastructure availability conflicts may occur during planning and real-time operations.

During the planning phase, schedules need to abide by the planning of maintenance and construction works throughout the network, which makes certain infrastructural elements unavailable (Christoforou et al. 2016). On the other hand, during real-time operations, certain infrastructural elements may become unexpectedly unavailable, as a product of disruptions or the need for contingency construction or maintenance works (Christoforou et al. 2016).

Circulation Conflicts

Circulation conflicts occur when the time difference between the arrival of a train at the station in which its transition towards a different train service is scheduled, and the scheduled departure of the train after the transition, is less than the minimum transition time required for the foreseen transition type (Bär 1996). The best example of a circulation conflict is a negative turn appointed to a train at a particular turning station.

Furthermore, circulation conflicts may also occur as a result of a lack of vehicles that can be appointed to a specific train service (Borndörfer et al. 2009). For example, due to unresolved end-of-day imbalances.

Connection Conflicts

A connection conflict takes place when passengers in a delayed feeder train are not capable of reaching their connecting train services at their predefined stations, taking under consideration the minimum platform exchange time for passengers (Stelzer 2016). Broken connections have a significant effect on passengers, as it induces uncertainty regarding the course of their trips and a dramatic reduction in the perceived quality of service (Stelzer 2016).

Follow-up Conflicts

Follow-up conflicts refer to any conflict, regardless of its type, that is induced due to the implementation of a conflict resolution alternative (Oetting et al. 2011). Follow-up conflicts represent a projection or a 'look-ahead' on the operating situation after the actual or prospective implementation of a dispatching measure, or conflict resolution alternative in a CDCR process (D'Ariano 2008).

Conflict Classification

Conflict classification refers to the categorization of conflicts into groups by recognizing specific characteristics. The classification of conflicts facilitates a rapid and effective conflict resolution (Neuber 2017). Conflicts can be classified based on different characteristics, for example, establishing conflicts that have a similar influence on the operating situation, or conflicts that may require the same elemental conflict solution alternatives to be resolved (Neuber 2017).

Furthermore, the establishment of conflict kinds within the same conflict type (e.g. occupancy conflicts) already represents a classification scheme. For example, Neuber (2017) introduces an approach to classify occupancy conflicts by observing specific operating situations such as conflicting sections on the infrastructure and conflicting train sequences. The classification approach introduced in Neuber (2017) establishes an operational classification framework, which is able to distinguish between seven different operating situations.

The above-described principles have been utilized in models such as in Jacobs (2004), Oetting et al. (2011), Oetting et al. (2013), among others.

Conflict Sorting

Conflict sorting refers to the order in which conflicts are being considered for their resolution. The sorting, therefore, is an indirect prioritization of conflicts that can be based on different criteria. Among existing approaches, the sorting of conflicts based on their temporal occurrence is the most utilized sorting criterion (e.g. Oetting et al. 2011, Oetting et al. 2013).

Nonetheless, the sorting of conflicts can be expanded to consider further characteristics, for example, based on the locations in the network in which conflicts take place (e.g. LtfTS), based on the established conflict severity, or prioritizing certain conflict classes which are deemed to be of particular importance for achieving context-specific dispatching objectives.

Conflict Severity

Conflict severity refers to the relative impact of a conflict on the actual operating situation. Currently, there is no proven best approach to establish the severity of a conflict. However, a particularly relevant method has been proposed by Oetting et al. (2013). In their approach, the authors describe the severity of a conflict through the use of a "probable" conflict resolution. The "probable" conflict resolution must be selected from a set of alternatives that is representative of the actual operating situation. The fitness of the selected alternative, which is established by the utilized evaluation function, is set to describe the severity of the identified conflict.

Disposition Measures as Elemental Conflict Solution Alternatives

In this subtitle, single disposition measures utilized to solve conflicts across both operational levels featured within the dynamic DRP deployment system (i.e. line and vehicle-specific operational

levels), are described. The contemplated measures have been collected from the literature review (see subsection 2.2 and 2.3), interchanges with practitioners (Stemer 2018), and guidelines like the one available for the German commuter railway operator (DB Regio) for the implementation of DRPs (i.e. DB Regio RIL-615 2014).

The described measures (i.e. elemental conflict solution alternatives) can be applied to individual lines or trains and are not exclusive to their utilization within disruption-management processes. Furthermore, as all possibilities are being contemplated, the alignment of the described measures with the system's overall approach (see subsection 3.5.2) has not been fully considered. Therefore, the interplay and specific implementation of the measures described within this subsection are explored with much closer detail in later sections of this work (see section 6).

Exchange Train Between Lines

The measure contemplates exchanging a train between lines of the same network. This implies that both the schedule and the circulation plans assigned to the vehicle or vehicle composition of the said train are exchanged to those of a different line. The measure has been indirectly implemented across different schedule adjustment models (see Ghaemi et al. 2018a, 2017, 2016, Veelenturf et al. 2016, Louwerse and Huisman 2014, Nielsen et al. 2012, etc.).

While in the above-detailed models, the measure is used without any explicit restriction regarding the reassignment of trains across lines of the same network, there are instances in which the exchanges can only be conducted between trains of corresponding lines or “train groups” (Nakamura et al. 2011).

Incorporate External Train

Incorporating an external train entails assigning a vacant train service to a vehicle or vehicle composition that was not circulating in the network before the disruption. Incorporating a vehicle or vehicle composition requires a verification of its service availability. Only after the service availability has been verified, the train can be appointed a train service's schedule and circulation plan. A similar version of the measure has been implemented in Veelenturf et al. (2016) and indirectly observed in Wagenaar et al. (2017), Nielsen et al. (2012).

Remove Train from Circulation/Park Train

The utilization of this measure entails sending a train to one of the parking locations available throughout the network. The measure constitutes a central part of the developmental framework of DRP operating concepts, being contemplated in Chu et al. (2012) and Brauner (2019). During the deployment of DRPs, trains are sent to their assigned, or eventually, any parking location in order to match the disrupted capacity of the network with the number of trains in circulation (Brauner 2019).

The measure has also been utilized in Fekete et al. (2011), Veelenturf et al. (2016), and indirectly in Wagenaar et al. (2017), Nielsen et al. 2012.

Transferring Train

The transferring of a train assigns a train an entirely different string of nodes to the ones observed in its original schedule. The measure is utilized to avoid and surpass the disrupted section and has been used as a central measure in Veelenturf et al. (2016) and listed as an available option for the

development of DRPs (Chu et al. 2012, Brauner 2019) and detailed in the guideline RIL-615 (DB Regio RIL-615 2014).

Considering that commuter railway networks are much more reduced in size when compared to their regional or long-distance counterparts, the paths that can be used for transferring a train are much more limited. In this context, as discussed with active train dispatchers (see Stemer 2018), the deviation is referred to as a transfer and entails a deviation of trains through an alternative driving path to move vehicles from one side of a fully disrupted network to the other.

(De)Couple Train

As a measure, it foresees the coupling or decoupling of vehicles or vehicle compositions appointed to one or more train services. If coupled, a new vehicle composition is assigned to a train service (i.e. less traffic) and if decoupled new vehicles or vehicle compositions are assigned to two or more train services (i.e. more traffic). The measure has been used in models such as Haahr et al. (2016), Wagenaar et al. (2017), Nielsen et al. (2012).

It must be clarified that the measure does not refer to shunting movements performed to establish vehicle compositions.

Cancel a Stop

The measure foresees the cancellation of one or more stops contained in the schedule of a train service. The cancellation of the stop would allow a train to reduce its overall journey time (i.e. shorter occupancy times) or utilize a track through the station without a platform.

On the other hand, the cancelling of a train service's stop at a particular station may lead to an overcrowding of passengers on the platform. Thus, inducing longer dwelling time in the affected station for later trains due to an increase in the passenger exchange time (Stelzer 2016).

Early Turn Train

The early turning of a train implies that a train finalizes its service in any given station before reaching its scheduled end station and changes its driving direction so that it can be appointed a train service in the opposite direction. It must be considered that the transition train service appointed to the train after the turn may also need to begin its service from a completely different station as the one that was originally scheduled. As a result, the early turn may induce a great impact on the serviceability of the two train services involved in the early turn. On the other hand, since the measure would allow turning trains in any station prior to the LtFTS, early turns may be particularly handy to deal with the queuing of trains in the critical area (Ghaemi et al. 2017).

The early turning of trains is a measure widely utilized throughout multiple disruption-management models (e.g. Fekete et al. 2011, Ghaemi et al. 2016, 2017, 2018a, Veelenturf et al. 2016, Louwerse and Huisman 2014, etc.). The measure has also been utilized for the development of DRP operating concepts (e.g. Chu et al. 2012, Brauner 2019) and detailed in guidelines (e.g. DB Regio RIL-615 2014). Consequently, it constitutes one of the central measures available to dispatchers during disruptions.

Shift a Train in Time

By implementing this measure trains are shifted in time so as to make their movement across the network compatible with: other trains, the system's operational constraints, and or their own

scheduled operations. The measure assigns trains a non scheduled waiting time at any location (i.e. station, junction, etc.) in the network where they are able to stop, or modifies an already existing waiting time (Chiang et al. 1998, Oetting et al. 2011, Oetting et al. 2013).

Bend Train

Bending a train refers to prolonging or reducing its journey time within a given stretch of its route to make its journey compatible with the operational constraints. The implementation of the measure is conducted by modifying the driving time of one or all trains involved in a conflict and it can even be rendered as part of strategies that foresee the shifting of trains in time, as explained in Oetting et al. (2013).

The term “bend” refers to the adjustment of the speed of a train. According to Oetting et al. (2013), there are two different kinds of train bending. A positive bend, which entails an increase of a train’s journey time within a portion of its route. A negative bend, which entails a reduction of a train’s journey time within a portion of its route.

Whereas the measure is not directly included to this point in disruption-management models, it has already been adeptly utilized for dealing with disturbed situations in: Jacobs 2004, D’Ariano 2008, Pellegrini et al. 2014, among others. A similar measure has also been utilized to reduce the stopping time at a station, as explained in (Oetting et al. 2013).

Reroute Train

In opposition to the measure transfer or deviation that modifies the driving path of a train, the rerouting entails a modification of a train’s scheduled route throughout particular nodes and/or links. The measure also includes the changes of platform tracks, at the specific stations.

The rerouting, as understood above, is utilized in both scheduling and rescheduling models (see Jacobs 2004, Oetting et al. 2011, Oetting et al. 2013), and indirectly in Ghaemi et al. (2018a).

(Partially) Cancel a Train Service

By the utilization of this measure, train services can be entirely or partially cancelled. While a total cancellation affects the whole route of the train service, the partial cancellation affects only certain portions of the route.

The measure is also widely utilized across multiple disruption-management models e.g. Chu et al. 2012, Jacobs 2004, Ghaemi et al. 2018a, Veelenturf et al. 2016, Nakamura et al. 2011, Nielsen et al. 2012, etc.), DRP development models (e.g. Chu et al. 2012, Brauner 2019), and detailed in guidelines (e.g. DB Regio RIL-615 2014)

Alternative train service

The use of an alternative train service is a measure that allows either moving vehicles or vehicle compositions around the network, or servicing certain sections with train services that are not contemplated in the original schedule or the DRP operating concept. If the trains are empty (not providing any service), these have also been called dead-heading trips (see Waagenar et al. 2017).

Transfer of Passengers’ Waiting Time

As regular connection conflicts are not characteristic for commuter railway networks (see subsection 3.3.2), passengers’ welfare must be directly addressed. The measure is used to shift the

passengers' waiting time at a specific station between a cancelled train service and a subsequent train service. The measure supports the system's ability to account and track the load, which is shifted to passengers' welfare during the disruption-management. Ultimately, since the measure is advanced to address the specific purpose of the dynamic DRP deployment system, it has not been considered in any of the existing models, guides or guidelines.

3.7. Definitions Utilized within this Work

Within this subsection, the definitions introduced specifically to advance both *Sections* of this work are discussed in detail. Each of the definitions being advanced throughout this section have been modified and or extended from the literature review.

3.7.1. Section 1 – Residual Capacity for Passenger Rerouting

Mobility Center of Gravity

The mobility center of gravity refers to the most dominant location in the urban environment from the point of view of the local public transport network. In overall, the mobility center of gravity constitutes the main objective and source of the trips generated within a public transport network, also taking transit or transference trips under consideration.

For the appraisal of rerouting strategies targeted at addressing disruptions in the commuter railway network, the mobility center of gravity, also represents a critical objective and even potential source of rerouted passenger trips. Ultimately, the mobility center of gravity is also a critical location against which the Occupancy Rate (OR) of the different public transport means can be referenced.

3.7.2. Section 2 – Dynamic Deployment of Disruption Programs

Spatial Definitions

Disruption Divided Network and Sides

Depending on the magnitude and location of the disruption, a commuter railway network may be divided into two different sides.

If the cause behind the disruption has been dire enough to impede the circulation of trains in both driving directions, a complete blockage of the commuter railway network has occurred. On the other hand, if it is still possible to maintain trains circulating in at least one direction, only a partial blockage of the network has taken place.

In complete blockages (see figure 3.6-A), the overall disruption-management and the deployment of the DRP operating concepts must distinguish between two different sides. However, the network may be assumed to be “partially” isolated, as it is likely that there are potential deviation paths available to link both sides of the disrupted network. The available deviation paths can be directly utilized as detailed by the DRP operating concept of specific lines, or as alternatives to support the disruption-management efforts.

In a partial blockage, it is still possible to connect both sides of the network through the infrastructural elements that have not been directly affected by the disruption (see figure 3.6-B). However, in a partial blockage, due to the nature of the measures foreseen in the DRP operating

concepts (see table 2.4), it is possible that some lines still need to be considered as being divided into two different sides. Furthermore, available deviation paths routed may also be utilized (see table 2.4).

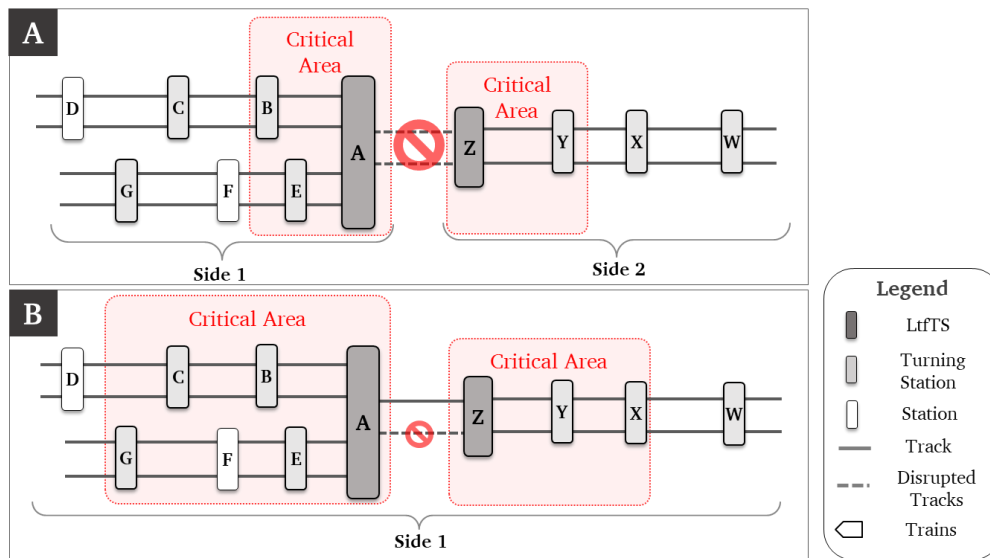

Figure 3.6 Example of two different critical areas and a complete (A) as well as a partial blockage (B) (by author)

Critical Area

The critical area refers to the most vulnerable area of the commuter railway network during the disruption-management and essential for ensuring the transitioning to stable operations. As has been discussed by Oetting and Chu (2013), at the beginning of the disruption, it is almost certain that train queues would form around stations located in the vicinity of the disrupted section. Therefore, the critical area is inherently originated around the disrupted section and extends itself to include, as many turning stations as deemed relevant for conducting a proficient disruption-management.

For example, in Ghaemi et al. (2017), the LtfTS is referred to as the primary turning station. However, the authors also highlight the relevance of the preceding turning station for an enhanced management of the disrupted operations, which is then referred to as the secondary turning station. As a result, the critical area is extended to include the last two technically feasible turning stations on every line connecting to the disrupted section, as detailed in figure 3.6-B.

Nonetheless, in order to allow the system to adjust its complexity to the available computational effort (see subsection 3.4.2), the amount of turning station considered to be part of the critical area within the dynamic DRP deployment system can be adjusted to the context-specific needs. However, regardless of the type of disruption, whether complete or partial, the critical area must include at least all LtfTS. As the standard approach for the dynamic DRP deployment system, it is recommended that the critical area extends itself to cover two technically feasible turning stations before the disrupted section (including the LtfTS), as in figure 3.6-A.

DRP Relevant Infrastructural Elements -- First-order Infrastructural Elements

The DRP relevant infrastructural elements refer to the infrastructural elements utilized in DRP by the line-specific measures foresaw in the operating concepts of each of the affected lines (see table 2.4 – subsection 2.3.3).

Given the need to establish further alternatives for the handling of trains in the infrastructure and support the transition to stable operations, the DRP relevant infrastructural elements are also recognized as first-order infrastructural elements.

Second-order Infrastructural Elements

The second-order infrastructural elements constitute the elements that provide a broader range of alternatives for the handling of trains throughout the infrastructure, supporting the transition to stable operations. Second-order infrastructural elements are appointed to specific elements that may support the ability of a given train to reach its DRP foresaw route or any of its DRP relevant infrastructural elements. Second-order infrastructural elements can be pre-emptively established for their utilization in the dynamic DRP deployment system.

(Un)Conventional Parking Locations

As detailed in subsection 3.6.2, parking locations refer to any railway facility in which a train can be shut down, namely, shunting yards, shunting tracks, platform tracks in stations. The dynamic DRP deployment system makes a distinction between conventional and unconventional parking location to further support the selection of specific parking locations during disruptions.

Conventional parking locations are specific for every line and refer to parking locations generally utilized by the vehicles of such lines (e.g. at or around end stations). Furthermore, considering the existence of the DRP operating concepts, these may detail typical DRP parking locations to be utilized by a line during the disruption. Finally, in order to expand the available alternatives, all parking locations within the commuter railway network that can be immediately accessed (i.e. without any deviation) along the line's route from both driving directions may also be considered as conventional parking locations.

Unconventional parking locations are specific for every line and also highly dependent on the operational circumstances of the network. Unconventional parking locations are explored if there are no available parking positions in the conventional parking locations of a line. Unconventional parking locations include:

- parking locations that are not immediately accessible along a line's route, thus, require to deviate the train away from its scheduled route,
- parking locations outside of the commuter railway network,
- and potentially available (i.e. highly dependent on the time of day) platform tracks throughout the different stations along a line's route.

Temporal Definitions

System Deployment Time

The system's deployment time refers to the specific time in the dispatching system in which the dynamic DRP deployment system is implemented. The deployment time is most likely to be equal to the moment in which a DRP operating concept from the set of all DRPs available for the network, has been chosen.

Supplement Transition Time

A supplement transition time refers to a supplementary time introduced to the minimum transition time between train services to account for the stochastic nature of these processes, particularly during disrupted operations.

A supplement transition time for turning trains has already been established in the work of Chu (2014), distinguishing between turns with one and with two drivers available on the train (see subsection 2.3.3).

Turn Residual

The turn residual refers to the delay or waiting time induced after appointing a train with an (early) turn and a transition to train service in the opposite direction at a specific location along its route (see figure 3.7). The turn residual can be expressed as a function of the transition train service which is foreseen to be serviced by the train after its turn and the selected turning station. As a result, the turn residual can be instrumental in evaluating the effect of (early) turns on the operating situation of the railway network.

The turn residual is equal to the difference between the scheduled departure time of the transition train service (i.e. in the opposite direction) minus the addition of the projected arrival time of the train to the turning station, the train's original delay, and the minimum turning time.

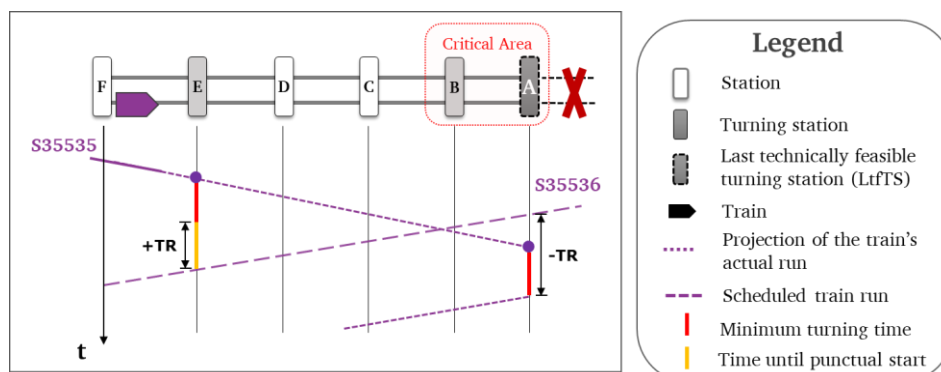

Figure 3.7 Example of positive and negative turn residuals (by author)

As a result, the turn residual provides a positive or negative temporal value. If the value is positive, it amounts to the waiting time required by the train at the turning station before its scheduled departure, as depicted in figure 3.7 (turn in station E). If the turn residual provides a negative value, it refers to the delay induced by the (early) turn of the train at the selected tuning station, as depicted in figure 3.7 (turn in station A). Ultimately, it is possible to appreciate that just by merely changing the turning station and maintaining the same transition train service, the operating situation after the (early) turn varies quite broadly.

End-of-day Operations

The end-of-day operations is a line-specific quality and refers to the last train service in the schedule to be serviced by a line. Thus, the end-of-day operations acquire a temporal value equal to the scheduled arrival time of the last train service at its end station.

Beginning of Operations

In the same way, the beginning of the operations is a line-specific quality, which acquires a temporal value equal to the scheduled departure time of a line's first train service from its beginning station.

Passengers' Waiting Time

The passengers' waiting time is the additional time passengers must wait at a station due to the cancellation of a train service. The passengers' waiting time is constituted by the timespan between the scheduled departure time of the cancelled and a subsequent train service. A subsequent train service entails a train service projected to arrive at the affected station after the scheduled departure time of the cancelled train service and that allows passengers to reach the same end station as the cancelled train service. Thus, it takes into consideration trains from other lines, which may allow passengers to fulfill their trips. Further insight regarding the selection of subsequent train services is provided in the subtitle: *Operational Level – Generated Service Interval*.

Scheduling Definitions

Potential Vehicle-Specific Conflict Solutions in Time and Space (PVSCS)

Potential vehicle-specific conflict solutions in time and space refer to the conflict resolution alternatives generated at the line-specific operational level, which are appointed to specific vehicles or vehicle compositions (i.e. trains). Overall, the PVSCS derive from an identification of the line-specific conflicts induced by the disruption, the deployment of the DRP operating concept and the actual location of each train in the disrupted network.

Each PVSCS contains the necessary information to support the adjustment of the schedule and circulation plan. Therefore, a PVSCS is developed by selecting one or more line-specific elemental conflict solution alternatives and implement them at a vehicle-specific level. The chosen alternatives permit to establish the spatiotemporal information outlining a train's movement throughout the network. The spatial information establishes one specific route through the infrastructure and complements this information with the temporal information, namely, the respective journey, arrival, and departure times. The temporal information may be derived either from the original schedule or the infrastructure model (i.e. considering the respective model train - see subsection 2.2.2). Furthermore, the PVSCS also contains an adjusted circulation plan for the train in the form of a set of transition train services, which are aligned with the elemental conflict solution alternatives that have been utilized for its development (e.g. turns, coupling, decoupling, etc.). One aspect that is not supported in a PVSCS is the interaction with other trains. PVSCS are developed by considering an empty network (see subsection 3.5.2).

Ultimately, since it is possible that a series of locations in the network (e.g. turning stations, deviations points, parking locations, etc.) and or transition train services, can be paired with the selected line-specific elemental conflict solution alternative to address the line-specific conflict, different PVSCS must be developed to explore the broadest range of possible alternatives. Thus, all generated PVSCS for a train are stored in a PVSCS set for the respective train.

Operational and Technically Feasible PVSCS

The dynamic DRP deployment system intends to endeavour the exploration of the widest range possible of alternatives for the adjustment of the schedule and circulation plans to the actual

operating situation induced by the disruption (see subsection 3.5.2). However, the system is also required to advance an effective and efficient structure (see subsection 3.4.2). Therefore, every PVSCS that is generated must have its operational and technical feasibility verified.

The verification of the operational and technical feasibility is understood as in (Oetting and Chu 2013, Brauner 2019, and Brauner and Oetting 2019). A PVSCS is said to be technically feasible if the characteristics of the model train are compatible with the infrastructural requirements along its route. A PVSCS is said to be operationally feasible if it is able to facilitate a transition to stable operations. This implies that the resulting PVSCS does not induce a delayed train service or any induced delay must be reduced (until it is eliminated) when the train transitions between train services.

PVSCS Combination

A PVSCS combination is a set of PVSCS that contains one specific PVSCS for every train circulating in the network, including trains that are being introduced from parking locations. Since each train has its own particular set of PVSCS, there is potentially a broad range of PVSCS combinations that can be generated by the dynamic DRP deployment system.

Since single train PVSCS do not consider the interaction with other trains, PVSCS combinations must be fixed by means of a vehicle-specific CDCR process until they are conflict-free (see subsection 3.5.2).

Adjustment of a Conflict-free Schedule

The adjustment of a conflict-free schedule refers to the identification and removal of all unnecessary measures introduced during the automatic CDCR process at the vehicle-specific level and which no longer play a relevant operational role in the conflict-free schedule. The adjustment is based on the approach introduced in Chiang et al. (1998) and further expanded to include the handling of as many measures as possible.

Operational Levels

Line-Specific Conflicts

Line-specific conflicts refer to the operating challenges affecting a whole line. The challenges have been induced by the disruption and can not be isolated to one individual train service. Thus, the line-specific conflicts refer to the general dispatching challenges which may be potentially addressed by any of the trains providing service to an affected line.

Line-specific conflicts are identified by relating the chosen DRP operating concept and the operating situation of the network with the actual disrupted situation. Accordingly, line-specific conflicts stand in the forefront of the dynamic DRP deployment. The strategies included in the line-specific DRP operating concepts (see subsection 2.3.3) allow identifying two different types of line-specific conflicts, namely, vehicle availability and reachability conflicts.

Vehicle Availability Conflicts

Vehicle availability conflicts refer to the existence of either a surplus or lack of vehicles circulating in the network in correspondence to the disrupted operating situation of the line and the train services supported in the chosen DRP operating concept. Vehicle availability conflicts are of fundamental importance to adjust both the schedule and circulation plans.

Considering that the DRP operating concepts are detailed for every line and side (if necessary), vehicle availability conflicts are established for every line in view of the already tested measures (see subsection 2.3.3). The lack or surplus of vehicles is the result of contrasting the number of trains required to service the DRP operating concept and the number of vehicles available across each one of the lines per side (if necessary).

Reachability Conflicts

During the deployment of the DRP operating concept, trains ought to still follow their original schedule. Reachability conflicts are identified exclusively for train services that are not able to service their originally planned route either due to a complete blockage, their line's DRP operating concept, or a dispatching decision (i.e. failing to reach all its scheduled stations).

As a result, the system is in the need to identify reachability conflicts as the concrete means to handle the portions of the route which have been left unserved.

Vehicle-Specific Conflicts

In the context of the dynamic DRP deployment system, vehicle-specific conflicts refer to the four fundamental conflicts types that have been discussed in subsection 2.2.3, namely, occupancy, infrastructure availability, circulation and connection conflicts. These four conflict types are regarded as vehicle-specific conflicts since they are handled during the fixing process of PVSCS combinations (i.e. vehicle-specific operational level) (see subsection 3.5.2).

On the other hand, since part of the system's requirements is to create a framework to replace the expected lack of planned connections between train services, a new vehicle-specific conflict is introduced instead. Service conflicts are established in the system to support the monitoring and accounting of passengers' welfare.

Service Conflicts

Service conflicts occur when product of the cancellation of a train service at one or multiple train stations the service interval that is generated surpasses the maximum service interval allowed by the system. Therefore, rather than focusing on the misalignment of two corresponding train services at a given station as in connection conflicts, service conflicts focus on a train service that fails to reach one or more stations in its schedule. Service conflicts are advanced as part of the dynamic DRP deployment system, as the means to take into consideration passengers' welfare, upholding the service quality of the overall disrupted network.

There are two potential approaches that can be utilized to handle service conflicts. Service conflicts can be handled separately (i.e. locally) at each of the affected stations, or in general for the whole set of stations affected by the cancellation of the train service.

Handling service conflicts for each station would entail ascertaining the influence of the cancelled service on the passengers' welfare at each affected station in the commuter railway network. On the other hand, handling service conflicts, in general, would entail focusing on the station with the direst induced circumstance.

While maintaining a general approach would allow a simplified handling of the service conflicts, it would not allow keeping track of the actual operational circumstances on the overall passenger transport capabilities of the system. Therefore, service conflicts are to be handled and considered for each of the affected stations separately.

Maximum Service Interval

The maximum service interval is a parameter that must be introduced in the dynamic DRP deployment system to establish the allowable timespan between two train services arriving at a station that have the same objective station. Considering that in the face of a disruption passengers try to uphold their travel chain as far as possible, the specific line number they utilize to reach their destination or another strategic location that allows them to do so is no longer a priority. Therefore, by establishing a maximum service interval, the system is able to impose a limit on the timespan that stations throughout the network are left without the service of a certain line.

The maximum service interval is a parameter that can be structured to have a static or dynamic nature. Structuring the maximum service interval as a dynamic parameter would entail that just as transport demand (see subsection 2.4.4), the maximum service interval would fluctuate as a function of the spatiotemporal aspects of the network. It can be made more stringent during peak-hours or in portions of the network that do not count with a robust service (i.e. outside of the core area). A static parameter would imply that the maximum service interval that is introduced is valid for the whole network regardless of the spatiotemporal aspects.

In the specific case of the dynamic DRP deployment system, the maximum service interval relies on the DRP operating concept of the cancelled train service's line. This also acknowledges that there is a DRP transport concept being deployed, and that part of its objective is to uphold the welfare of the commuter railway users (see subsection 2.4.2). Therefore, since the DRP operating concept has been developed in close account to passenger transport matters, the maximum service interval can be made equal to the service interval of the line as foreseen by its DRP operating concept.

By equating the maximum service interval with the service interval of the line as foreseen by its DRP operating concept, the dynamic DRP deployment system is further aligned with the transport concept being applied in parallel. However, the maximum service interval, as a parameter, can be easily adjusted to fit the context.

Ultimately, a service conflict can be positively identified if the generated service interval at a station is larger than the service interval detailed by the DRP operating concept of the line respective to the cancelled service.

Generated Service Interval

The generated service interval embodies the operating situation created at the given station due to the cancellation of a train service. To establish the generated service interval, the timespan between the last or previous and following or subsequent train services that are projected to reach the affected station must be recognized. However, since service conflicts are intended to include the passengers' perspective and safeguard their welfare, only the train services that are able to replace the role played by the cancelled service as part of the passengers' mobility chain should be considered. Therefore, not all train services that are projected to reach the affected station may be considered to establish the generated service interval.

Under these circumstances, the end station of the cancelled service is the most relevant aspect to take into account when selecting the previous and subsequent train services. In overall, within a disrupted commuter railway network, two different circumstances can be considered:

-
- The cancelled train service drives away from the disrupted section, in which case, the objective station is the line's end station.
 - The cancelled train service drives towards the disrupted section, in which case, the objective station can be considered as to be any station within the core area or the line's DRP turning station.

Consequently, to establish the previous and subsequent train services, the direction of travel of the cancelled train service and its end station must be considered carefully. This does not imply that the prior or subsequent train services must have the same end station as the cancelled train service, but the end station must be contained within their schedules.

While the end station of the cancelled train service is an important aspect to ensure that the passengers' welfare is upheld, the stations serviced along the cancelled train service's route is also of relevance. Therefore, to establish the prior and subsequent train services, the stations being reached by these services must be, at least, similar to the ones reached by the cancelled train service. Whereas it is possible to quantify the similarity of the reached stations (e.g. percentage), establishing a precise amount that would allow upholding the passengers' welfare is a more complicated task. Therefore, the stations being reached by the prior and subsequent train services should be identical to the ones reached by the cancelled train service.

As a result, the generated service interval is derived by identifying the previous and subsequent services that are projected to reach the affected station, and that will allow passengers to reach every station of the cancelled service.

Once the prior and subsequent services have been established, the generated service interval is considered between the departure times of these services. The departure times are utilized since the stopping times at the different stations and the circulation plans of the prior and subsequent train services might vary broadly, which would affect the usage of the arrival time.

Unnecessary Measures in a Conflict-Free Schedule

This term is extended from the considerations made by Chiang et al. (1998), where shifts in time that were implemented to solve conflicts during the CDCR process are no longer operationally relevant for the resulting conflict-free schedule. The lack of relevance of the measures renders them to be unnecessary. Thus, they may be removed from the schedule. In view of the different elemental conflict resolution alternatives that can be implemented, the term can be extended to cover any vehicle-specific elemental conflict solution alternative.

Changes in the Projected Operating Situation

The induced changes in the projected operating situation refer to the fluctuation in the number and severity of the conflicts in the current conflict list due to the prospective implementation of a conflict resolution alternative. This includes all conflicts plus follow-up conflicts induced by the implementation of a conflict resolution alternative, supporting the look-ahead capability required for the dynamic DRP deployment system.

3.8. Structure of the Work

As it has been explained in subsection 3.1, this work is divided into two methodologically extensive and unrelated *Sections*. *Section 1* focuses on the development of the residual capacity estimation

model and *Section 2* details the development of the dynamic DRP deployment system across all its nine modules. The overall structure of the work is depicted in figure 3.8.

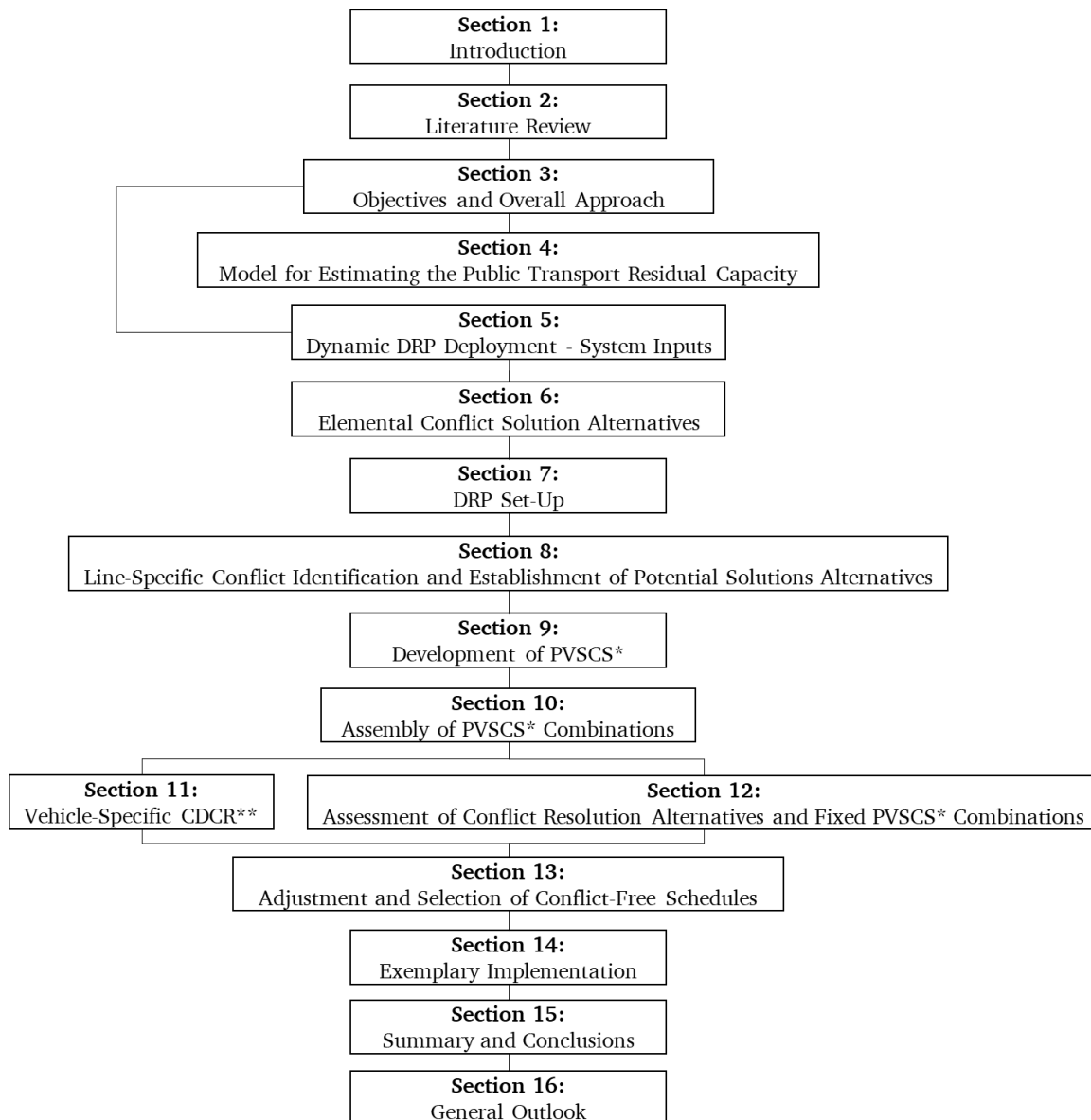

* PVSCS: Potential Vehicle-Specific Conflict Solutions in Time and Space

** CDCR: Conflict Detection and Conflict Resolution

Figure 3.8 Structure of the document (by author)

The first *Section* of this work establishes the model for the appraisal of the public transport residual capacity, which is advanced in section 4. Section 4 also includes a brief example regarding the application of the model, a brief summary, and conclusions for this *Section* of the work.

The second *Section* and the core of this work, is covered between sections 5 to 15, as it is depicted in figure 3.8. Aligned with the dynamic DRP deployment system’s overall approach detailed in subsection 3.5.3, every section between section 5 until section 13 details a specific module of the system. Section 14 provides an implementation example of the main processes described through the system’s modules, and section 15 provides a summary and conclusions regarding the development of the dynamic DRP deployment system (i.e. *Section 2*).

At last, the work finalizes in section 16, where a general outlook covering both *Sections* is provided.

4. Model for Estimating the Public Transport Residual Capacity

4.1. Introduction

As discussed in subsections 2.3.3 and 2.4.1, estimating the capacity limitations of public transportation modes available during a railway disruption is central for upholding the welfare of public transport users in general. Once the capacity limitations have been determined, intermodal passenger rerouting strategies that take advantage of existing public transport structures and the responsible utilization of their available capacity, can be achieved.

The immediate availability of this information stands as a cornerstone when identifying the most effective rerouting locations and channels for the development of transport compensation measures for passengers. This section focuses on developing a public transport residual capacity estimation model, as outlined by the specific objectives, requirements and limitations discussed in subsections 3.2.1, 3.3.1 and 3.4.1.

To fulfill the specific objective of the first *Section* of this work (see subsection 3.2.1), a model must be derived such that it allows conducting an assessment of the intermodal passenger rerouting strategies foreseen by a DRP transport concept based on an estimation of the residual capacity of the utilized public transport means. The assessed passenger rerouting strategies are the foundation for a later much more in-depth deliberation with local public transport operators. In overall, the model must be able to support a prompt estimation of the capacity limitations of the public transport means with general validity and regardless of the implementation environment (i.e. means of public transport and layout of the network).

As discussed by this *Section's* general approach described in subsections 3.5.2 and 3.5.3, this section is structured in three general clusters. The first cluster focuses on identifying key determining variables influencing the residual capacity estimation from existing research. Additionally, a general approach that permits to estimate the residual capacity according to the hitherto described objectives and requirements (see subsections 3.3.1 and 3.4.1) utilizing the identified key determining variables and proposing general assumptions should be outlined. The second cluster entails a validation of the general approach and the proposed assumptions so as to operationalize the residual capacity estimation framework in line with the identified key determining variables. The validation should focus on the scrutiny of actual operational information. Finally, the third cluster is aligned with the overall approach discussed in subsection 3.5.2, where a model supporting the assessment of passenger rerouting strategies based on an estimation of the public transport residual capacity should be laid out.

In the following, subsection 4.2 provides a detailed discussion of the key determining variables influencing the residual capacity estimation. Thereafter, subsection 4.3 utilizes the key determining variables established in subsection 4.2 and derives a general approach that permits to estimate the residual capacity based on a series of leading assumptions. Later, subsection 4.4 details the scrutiny of operational information, which permits to validate the relevance and functionality of the assumptions introduced in subsection 4.3 for their subsequent incorporation in the model. Subsequently, in subsection 4.5, the model supporting the assessment of passenger rerouting strategies based on an estimation of the public transport residual capacity is derived. The model incorporates the validated and, if necessary, modified general approach detailed in subsection 4.3. The proficiency of the model is later demonstrated in an actual case study (see

subsection 4.6). Finally, section four concludes with a general discussion and reflections on the model's applicability (see subsection 4.7).

4.2. Key Determining Variables Influencing the Residual Capacity Estimation

Assessing public transport capacity limitations entails engaging with features that relate to both the public transport planning and management phases. The public transport capacity analysis framework described in subsection 2.4.4, and the residual capacity definition discussed in 2.5.5, guide an estimation of the capacity limitations of a public transport structure. The capacity limitations have been ultimately described as the difference between the scheduled and demanded public transport capacities.

The direct liaison between scheduled and demanded public transport capacities has been typified by equation 2.17, where the residual capacity is expressed as the multiplication of the scheduled capacity C_j of a line j by 1 minus the occupancy rate $OR_{j,n}$ expressed as a ratio.

Since the residual capacity is contingent on the reaction of users to the scheduled operations of the different public transport modes, it is necessary to contemplate the liaison behind these two features. For the development of a model to promptly estimate the capacity limitations of any public transport structure, it is necessary to define the key determining variables that best describe the liaison behind scheduled capacity and passenger transport demand.

Drawing upon the capacity-focused discussion of subsection 2.4.4, six determining variables have been identified to hold prime relevance. These have been grouped according to scheduled or demand features and, thus, arranged in such a way to support a multimodal analysis of the residual capacity (see table 4.1).

Table 4.1 Isolated key determining variables influencing the estimation of the residual capacity (by author)

Residual Capacity of Public Transport Systems (Bus - Tram - Metro)	
System Scheduled Operational Variables	Demand & Context Dependant Variables
Vehicle Hauling Characteristics	Vehicle Occupancy
Mode/Line Operating Frequencies	Time of the Day (i.e. HVZ, NVZ, SVZ)
Mode/Line Route Distances	Distance to the Center

The scheduled assets provide the groundwork for the assessment as they reflect the functional structure of the public transport systems in question. As clearly acknowledged in subsection 2.4.4, these variables are built over specific mode and line qualities (i.e. vehicle characteristics, line types and their scheduled frequencies) and shape the scheduled capacity.

On the other hand, passengers' public transport demand is mainly constituted by the local mobility culture and reflected in the actual occupancy of the public transport scheduled journeys. Also, it must not be forgotten that the systems' configuration is deliberately modified throughout the day to better fit the demand fluctuations across the urban area. The shifts in the systems' configuration lay the foundation for determining the system's residual capacity potentials, thus leading the spatiotemporal influences behind both scheduled and demand features (i.e. peak and off-peak hours, the relevance of the urban center) to gain particular relevance.

Accordingly, the features in both groups must be explained in detail. This will help clarify the dynamic nature behind public transport demand, as well as the multimodal nature needed for its analysis. To this end, each of the six individual determining variables detailed in table 4.1 is

explained along with the characteristics that have been discussed throughout subsection 2.4.4, as well as with the model's overall objectives, requirements and limitations.

Vehicle Hauling Capabilities

Vehicle characteristics are specific to every transport mode and are among the most immediate variables influencing the scheduled capacity of a particular public transport line. From their operating characteristics (e.g. acceleration or braking) to their passenger hauling or transporting capabilities, there is a broad range of features to be considered. It is through this characteristic that each transport operator is able to arrange their own diverse set of vehicle types and models to better address the foreseen demand in their network.

For capacity assessment purposes, the number of users a vehicle is able to transport is a key feature. Consequently, within the framework of this *Section* and as an important variable within equation 2.1, the vehicle characteristics must be well-defined by the overall standing and sitting places available within an operating unit. However, it is necessary to mention that while the total passenger capacity remains constant, the difference in available capacity fluctuates throughout the day along with peak and non-peak hours. Therefore, it is important to adjust this feature accordingly to keep the gap between scheduled services and public transport demand as tight as possible.

Operating Frequencies

Like the previous determining variable, the operating frequency is also central for the assessment of the scheduled capacity of a public transport line. It is, as typified in equation 2.16, the temporal variable, which sheds light on the maximum number of vehicles that are being operated throughout a route within a given period. For capacity evaluating purposes, operational frequencies are denoted as the frequencies presented in the public schedule.

This variable covers not only the driving characteristics of the protracted mode but also the overall nature of the network. Eventually, just as vehicle characteristics, they may be adjusted to generate an operating program that better fits with the foreseen demand.

Network Spatial Qualities – Line Lengths

Network qualities highlight the spatial aspect of the system's operational features. As argued in subsection 2.5, the complexity of the network structures of public transport emphasize the need to distinguish between the spatial typology of the public transport lines.

The spatial characteristics are a relevant feature to consider during the residual capacity estimation due to the existence of divergent operating conditions among different line typologies (e.g. frequencies, journey length, distribution of the occupancy) and the fact that demand also fluctuates throughout space (see subsection 2.4.4). In the particular case of route lengths, line typologies are not only an indicator that can be used to evaluate the accessibility of the network by means of its catchment area, but they are also relevant in explaining the passengers' overall trip lengths. In this sense, different route lengths also impact on the protracted demand.

Vehicle-specific Occupancy – Critical Cross-section

Within public transport planning and management, assessing public transport demand entails a close observation of the passenger movement across the network. As discussed in subsection 2.5.5.,

the vehicle-specific occupancy is the cornerstone characteristic when conducting an estimation of the residual capacity of any public transport structure.

The vehicle-specific occupancy relates the number of passengers being hauled in a public transport vehicle throughout its route and considers this inside a framework of minimum standards. Therefore, the vehicle-specific occupancy expressed as an OR (occupancy rate) merges passenger transport demand behaviour with the scheduled services of a protracted public transport line providing mobility services within a given urban environment.

Acknowledging the fluctuations in passenger behaviour entails recognizing one of the main objectives of capacity planning (see subsection 2.4.4), namely, the deliberate adjustment of the scheduled capacity throughout the day to better fit the demand fluctuations at critical locations (i.e. decisive cross-sections). Thus, by equating the features of the scheduled capabilities with the public transport demand, as accurately as possible, the OR displays a dynamic nature.

Time of the Day and Distance to the City Center

The determining variables influencing the shifts in public transport demand go beyond the interaction between users and the planned public transport services to include the spatiotemporal aspects that characterize its dynamic nature. Since the appraised vehicle-specific occupancy information must be carefully contextualized as it forms part of the broader urban situation and its functions, the OR information must be handled to reflect the spatiotemporal variations in passenger transport demand.

As discussed in subsection 2.4.4, it remains of great importance to study the changes in public transport demand across the city, throughout the day, and throughout the week. The spatiotemporal nature of these shifts allows arranging the planned operations of the public transport network (i.e. changes in frequencies and vehicle characteristics across the network).

The temporal fluctuations in occupancy are inherently correlated with their geographical situation in the city. To explain these shifts, there is no better example than to refer to the changes regarding the overall direction of the trips generated in the network between morning and afternoon peak hours. In the morning, there is generally a strong flow of commuters driving towards the inner city area (e.g. CBD), and in the afternoon, the opposite takes place. Including the significance of the inner city area as an element to reference the temporal shifts in demand across the public transport network is instrumental for deriving an understanding regarding temporal fluctuations in occupancy.

The identification of a referencing element within the urban area is critical to generalize the changes in demand within the existing public transport structures vis-à-vis the urban functions. As discussed in subsection 2.4.4, the registered changes in demand may be referenced to a so-called “center of gravity”. Public transport demand is considerably influenced by changes in population density and the trip length towards the “center of gravity”, assumed to be the average objective and source of all trips generated in the network (see subsection 2.4.4). In this regard, the referencing element must be further detailed since it considers the trips conducted throughout all possible modes of transport.

In the specific case of public transport demand, it is necessary to establish a point, which is exclusively relevant to the public transport network in question. This point would be henceforth identified as the “mobility center of gravity”, and characterized by balancing the overall flow of passengers throughout the day within the public transport network. As discussed in subsection

3.6.1, the mobility center of gravity refers to the most dominant location in the urban environment from the point of view of the public transport network. Ultimately, the lines bridging such critical locations with the different commuter railway stations are particularly critical for passenger transport compensation strategies.

4.3. General Approach Towards the Estimation of the Residual Capacity

In this subsection, the conceptual approach that guides the structuring of a residual capacity estimation framework is presented in detail. The approach detailed in this subsection is aligned with the requirements and limitations explained in subsections 3.3.1 and 3.4.1, but above all else with the method detailed in 3.5.2.

The proposed structure streamlines the six key determining variables discussed in subsection 4.2, towards constituting a general residual capacity estimation approach for different public transport modes. All together, the approach is purposefully built to ascertain the gap between the existing capacity, made available by the scheduled operations, and the fluctuating spatiotemporal shifts in public transport demand at any given moment.

In the following subsections, the general approach to evaluate the residual capacity across its scheduled, demand and context-dependent components are derived. In subsection 4.3.1, the approach to ascertain the scheduled capacity is discussed. Later, in subsection 4.3.2, the approach to ascertain the demand and context-dependent components is derived and discussed. Within this subsection general assumptions to evaluate the OR of a public transport vehicle across its route are introduced. Finally, aligned with the requirements (see subsection 3.4.1), a validation procedure to be implemented on the assumptions derived in subsection 4.3.2 is structured in subsection 4.3.3.

4.3.1. Scheduled Capacity – Planned Operations

The proficient scheduling of public transport operations and the allocation of the scheduled capacity is at the core of public transport planning and management. This premise has been discussed in detail throughout subsection 2.4.4, describing the scheduled capacity as the product of the first three (of six detailed in table 4.1) determining variables relevant to residual capacity estimation.

The relevance of the first two variables (i.e. vehicle hauling capabilities and operating frequencies) can be immediately validated as they are circumscribed within equation 2.16. The mathematical expression relates the passenger hauling capabilities of vehicles that operate at a certain frequency within a given temporal interval (e.g. one hour), thus, establishing the scheduled capacity of a public transport mean.

By reviewing the existing schedule of the assessed public transport line, the operating frequencies can be unequivocally identified. Given that they describe the latest levels in capacity planning (i.e. Network - Mixed Traffic Oriented Capacity, see 2.4.4), the combined operational nature (i.e. more than one mean of transport) of the network's lines is already incorporated in their structure. Consequently, issues derived from the combination of different line structures are inherently included as part of the operational schedule, yet, the heterogeneous lengths of the public transport lines still play a role in the development of the public transport demand.

While the operating frequencies can be derived from existing schedules, establishing the passenger hauling capability of a vehicle assigned to service a specific journey is a more complex task. This can be done by means of standardized values to assert the maximum passenger hauling capabilities for different vehicle types. The best examples are the standardized values provided in table 2.5 in subsection 2.4.4 or the values provided by Schnieder (2015, p.68-72).

However, if a much more precise estimation wants to be conducted, a certain degree of operational knowledge regarding the studied network would be required. Thus, for a more accurate estimation of the scheduled operations, the actual vehicle carrying capabilities may be determined beforehand with the local public transport companies.

4.3.2. Occupancy Rate (OR) - Evaluating Assumptions

Whereas the scheduled capacity of existing public transport structures can be asserted by observing their functional structure, evaluating the public transport demand requires a much more comprehensive understanding. This is due to the complexity behind the passengers' travel behaviour (as explained in subsection 2.4.4.). Therefore, estimating the residual capacity of different public transport modes aligned with the specific requirements of the model, an evaluating approach that permits to handle the complexity behind evaluating the OR should be derived (see subsection 3.4.1).

At the outset, the OR has been described as being dynamic and holding strong spatiotemporal qualities. These qualities, which are deliberately aimed at addressing the fluctuating reaction of users to the scheduled services within an urban environment, have been consolidated in three demand-related determining variables (i.e. vehicle-specific occupancy, time of the day and distance to the city center –see table 4.1). Such generalizations are derived from the discussion on public transport demand presented in subsection 2.4.4, as well as by the relevance of the residual capacity discussed in subsection 2.5.5.

The OR, as generalized in equation 2.17 (see subsection 2.4.5) and complemented by the key determining variables discussed in subsection 4.2 may be expressed as a mode and time-specific function, which encompasses the distance to the mobility center of gravity as an independent variable. For this purpose, four assumptions have been concocted in the effort to streamline the discussed generalizations towards estimating the actual public transport utilization within the general approach.

It is assumed that along its route, the OR of a public transport vehicle can be expressed as a function of:

1. the time of the day (i.e. HVZ, NVZ and SVZ) and
2. its evaluated location in correspondence to a mobility center of gravity.

Furthermore, it is anticipated that the OR would:

3. experience a systematic growth as it approaches the identified mobility center of gravity and
4. produce maximum values during the peak hours of normal working days.

To illustrate the interplay between the proposed assumptions and the identified key determining variables, figure 4.1 sets them within a simple operational environment. The figure depicts the

interaction between the scheduled capacity (red bars) and the average changes in occupancy (gray bars) throughout a public transport vehicle's journey. Particular relevance is given to the changes in the vehicle's occupancy within a network by acknowledging the distance to the city center (i.e. mobility center of gravity), and the resulting passenger flow for the two illustrated line types (i.e. diametrical and radial lines).

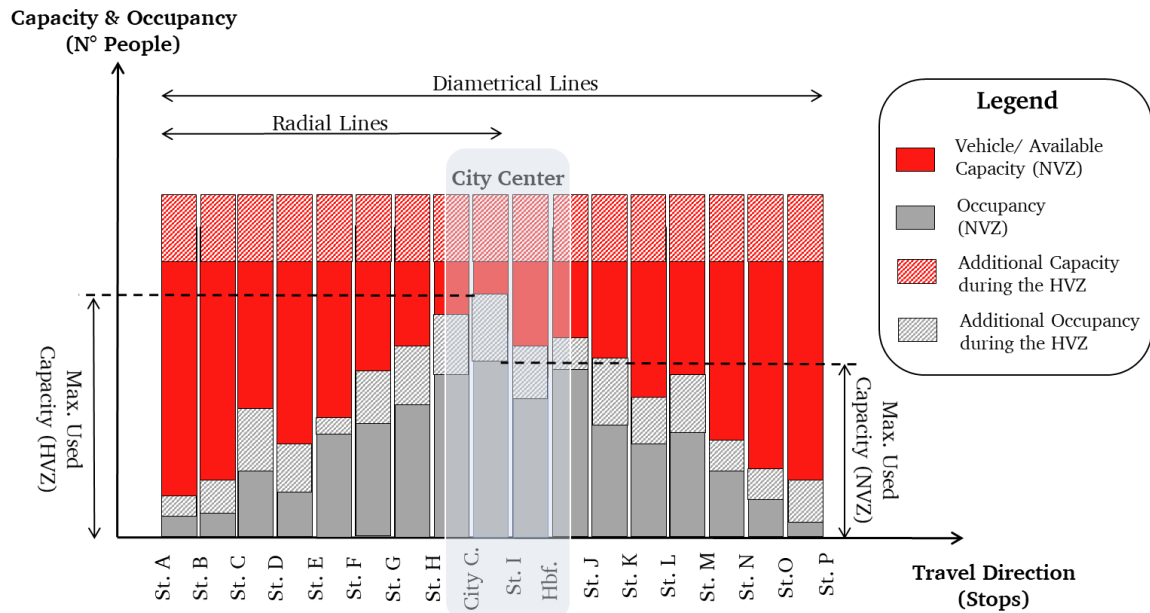

Figure 4.1 Assumed interplay between scheduled capacity and public transport demand (Crespo and Oetting 2018, modified by author)

By the same token, the relevance of acquiring a temporal perspective is represented in figure 4.1 by depicting the fluctuations of the OR across two different temporal categories, utilizing the HVZ and NVZ as examples. Furthermore, figure 4.1 also outlines the context in which the OR reaches its maximum values and the way in which these fluctuations could be potentially dampened by readjusting the scheduled capacity throughout the operational day.

To complement the discussed generalization and close the gap in the establishment of the OR as a parameter, the fluctuations of the OR in space must be explained by a theoretically derived mathematical function (see figure 4.2). Initially, since the OR is expected to produce a maximum value in the vicinity of the mobility center of gravity, and being this the point of reference, the mathematical function would necessarily possess a negative slope as the OR would decrease the further the vehicle gets from the city center or CBD.

Furthermore, as discussed in 2.4.4, urban density is highly intertwined with public transport demand and people's transport behaviour. Thus, the OR function may be affected by the changes in urban density. Urban density has been generalized as to grow towards the city center or CBD (see subsection 2.4.4). On the other hand, the public transport demand (i.e. modal-split) is also said to change in space across the urban landscape, where the selection of the travel mode changes according to its distance from the mobility center of gravity (i.e. total trip length) (see subsection 2.4.4). In this case, it is anticipated that the selection of the travel mode changes in detriment of public transportation. The combined effect of these two influences is assumed to have central relevance in explaining the rate in the fluctuations of the OR of a public transport vehicle along its route.

As a result, as depicted in figure 4.2, the OR function is assumed to:

- be explained by a monotonically decreasing function vis-à-vis its measured distance from the local mobility center of gravity. A linear function is utilized in figure 4.2 to simplify the representation of a monotone decrease in the OR of a vehicle along its route.

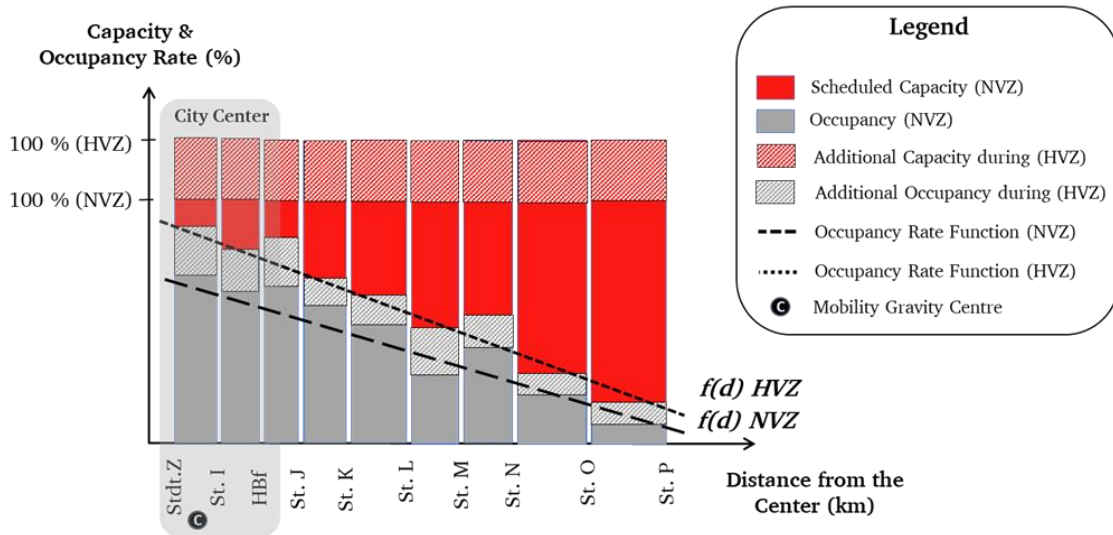

Figure 4.2 Route-base occupancy rate (OR) of a public transport vehicle expressed as a function of the spatiotemporal changes of demand (by author)

To substantiate the relevance of the isolated key determining variables and the informative value of the five assumptions proposed thus far, actual operational information must be gathered and assessed. For that reason, the systematic acquisition of this information and the structuring of an approach to assess the retrieved information becomes instrumental for determining the strived OR function, as outlined by the proposed assumptions.

4.3.3. Validation Procedure of the OR Assumptions

The assessment of actual operational information must be developed within the framework of the assumptions proposed in the previous subsection as well as by taking into account the requirements and limitations of the model (see subsection 3.3.1 and 3.4.1). In this subsection, the characteristics of the operational information and evaluation procedure to validate the proposed OR assumptions are outlined in detail.

Initially, the features of the required operational information to validate the assumptions and the assembly of the OR functions are detailed below. Later, a new procedure to process the retrieved information and structure the public transport and time-specific OR functions is proposed and described in detail.

Features of the Required Data

The retrieved operational data must convey specific features that make the validation process compatible with the general approach (as explained in subsection 3.4.1).

Since the most important attribute to be evaluated is the occupancy rate of vehicles across a network, the data must be collected employing public transport surveying techniques that capture information with the desired precision. Thus, despite its limitations, direct vehicle-specific passenger counts (see subsection 2.4.4) conducted throughout a particular set of journeys

constitute the most adept surveying technique. Information with this level of accuracy satisfies the required granularity, as it systematically records the number of passengers boarding and alighting from a line's timetabled journeys and/or the changes in passenger numbers between stops.

The recorded information must also take into consideration the relevance of the temporal changes in demand. Hence, the retrieved information must distinguish the variations in demand for at least an entire day of operations. Furthermore, the surveyed timespan must fall on a working weekday during the school season to capture the maximum demand values (as discussed in subsection 2.4.4).

Whereas the actual scheduling of public transport services requires a thorough evaluation of historic passenger surveys (i.e. a more extensive sample size), the collected information within the framework of this *Section's* requirements must properly validate or contest the assumptions made in 4.3.2. Therefore, since the model is to be used within the context of railway-disrupted situations to assess intermodal passenger rerouting measures that ought to be still deliberated with local public transport operators, the collected sample does not need to be so extensive. That said, for a proficient validation of the proposed assumptions and to secure the general implementation of the framework, it is advantageous for the collected information to be sourced from a wide range of technical and operational environments and including all public transport modes established by the requirements, namely, buses, light rail and subway networks (see subsection 3.4.1).

Data Evaluating Procedure

Once the passenger counts for all the timetabled journeys during an entire day of operations for a given set of lines and networks are available, the effective validation of the OR is divided into six steps. The steps derive from the capacity analysis as well as the features discussed within the key demand-related determining variables and should be conducted chronologically in each one of the evaluated public transport networks.

i) Establishing the mobility center of gravity

First, to calculate the route distances of all the scrutinized lines within a network, the respective mobility center of gravity must first be identified. Different approaches can be utilized to locate the mobility center of gravity of a public transport network. Each of the approaches would allow establishing the location with dissimilar degrees of accuracy and complexity.

Initially, an approach compatible with the available information (i.e. passenger counts for all the timetabled journeys during an entire operational day) can be derived based on the key demand-related determining variables discussed in subsection 4.2. The mobility center of gravity may be established in accordance with the decisive cross-sections through which the most significant passenger flows throughout the day have been considered. Daily flows at the cross-sections can be utilized so as to select stops which are decisive across all temporal categories. Furthermore, the decisive cross-sections should be carefully established so as to converge around one area, thus, allowing to consider the implications of other existing lines, public transport modes, and urban functions. Once these cross-sections are identified, a center of gravity is positioned in an attempt to equilibrate the strength of the net inflow and outflow of passengers traversing through the converged sections.

Nonetheless, existing approaches, such as the ones introduced in Oetting (2002), may also be utilized as alternatives to establish the mobility center of gravity.

Oetting (2002), introduces two approaches based on the transport-relevant features of the study area. The first approach foresees to divide the study area into “cells” or subareas, which are appointed with their transport relevant characteristics, such as, the number of inhabitants and transport offer. The modelling of the networks of the individual transport means allows establishing the transport supply and demand between “cells” (Oetting 2002, p. 203). The “cell” with the highest supply and demand can be identified as the mobility center of gravity. The second approach foresees the division of the study area in concentric circles. The circles are located such that the center indicates the location of the mobility center of gravity. This can be established by means of the transport supply and demand for the different routes towards the main destination area, which would constitute the mobility center of gravity (Oetting 2002, p. 204).

While the approaches proposed by Oetting (2002) can be utilized to establish the mobility center of gravity with a high degree of accuracy, they require collecting additional information regarding the transport-relevant features of the study areas. Additionally, the author also highlights that the processing time, if the whole system wants to be taken into consideration, may be of consideration (i.e. around six man-months for computing a whole city – see Oetting 2002, p. 204). Therefore, the approach described at the beginning of this point, which utilizes the daily flows at the cross-section, is the standard approach recommended for the validation purposes of the OR.

ii) Identifying the Temporal Categories

In a second step, the network’s peak (HVZ) and off-peak hours (NVZ; SVZ) must be identified. For this, the net inflow and outflow of passengers at the decisive cross-section for all passenger journeys per public transport line are broken into one-hour intervals and assigned to one of the three temporal categories (i.e. HVZ, NVZ or SVZ) on the basis their service intervals and the respective total number of services.

Since the information is specific to the direction of travel, it is first necessary to identify the point of the day in which the outflow starts dominating the inflow of passengers. At last, the temporal categories are decided by clustering each hourly interval ordered data pair (i.e. summarized passenger flow and the number of journeys for the one-hour interval) using an iterative approach, which adopts a centroid method (as in Milligan and Cooper, 1987).

The iterative clustering approach is structured as follows:

1. Each hourly interval representing a weekday (i.e. from Monday to Friday) is represented as an ordered pair of the form: X, Y; where X represents the total number of journeys and Y is the dominant flow of passengers. A preliminary clustering of each data pair to one of the three temporal categories w is conducted manually, so as to initiate the clustering process.
2. All pairs belonging to the same category w are averaged, constituting in this way the new centroids for each temporal category (i.e. \bar{X}_w, \bar{Y}_w)
3. The sum of squared differences between the original ordered pairs and the identified centroids for all temporal categories is calculated as generalized in equation 4.1.

$$Squared\ Difference = (X - \bar{X}_w)^2 + (Y - \bar{Y}_w)^2 \quad (4.1)$$

where:

X	Total number of journeys within the assessed hour interval
Y	Dominant flow of passengers within the assessed hour interval
\bar{X}_w	The resulting centroid of the number of journeys for temporal category w

\bar{V}_w The resulting centroid for dominant the flow of passengers for temporal category w

4. For each one of the ordered pairs, the temporal category of the centroid with the minimum square difference (calculated in step 3.) is identified. The resulting temporal category either confirms or signifies the need to exchange the previously assigned category for the respective ordered pair.
5. The sum of all minimum square differences is calculated as an overall indicator of the iteration.
6. Repeat steps two to five until the sum of all minimum squares, in step 5, does not fluctuate anymore after two consecutive iterations.

The approach can be introduced certain modifications if the information of weekend days wants to be supported. The same approach from steps 1 to 6 can be utilized with inflow and outflow of passengers respective to Saturdays and Sundays. Alternatively, the clustering process can also be conducted with passenger flow information regardless of these being week or weekend days, however, this is not aligned with the OR assumptions outlined in subsection 4.2.

iii) Route Length Normalization

Third, to make the lines with different lengths comparable between each other, the individual route lengths must be normalized. The normalization implies dividing the total route length by itself and making it equal to 1. The length at the intermediate stops becomes the cumulative fraction of the total length.

For the normalization, the total route length is defined as the computed vehicle's specific route distance between the identified mobility center of gravity and the line's end/starting stop. In the case of diametrical lines, these are considered as two radial lines separated at the identified center. Additionally, for lines that modify their scheduled route or route length throughout the operational day, the route length normalization must be conducted separately, by clustering all the journeys with the same characteristics.

Accordingly, the total route lengths result from measuring the covered route distance, from the line's first or origin stop to its stop laying the closest to the mobility center of gravity, plus the air distance from said point to the stop. To derive the actual distance between the mobility center of gravity and the stop, the air distance must be multiplied by a detour factor U_F (Walther, 1973 p.54), which allows the actual walkways to be traced to public transport stops. The detour factor U_F is calculated as generalized in equation 4.2; where l_H represents the air distance measured between the stop and the mobility center of gravity.

$$U_F = 1 + 5,841 * e^{-1,95 * l_H^{0,1}} \quad (4.2)$$

All measurements (i.e. between stops, from the stop to the mobility center of gravity) should be conducted via web mapping services (e.g. Google maps) and supported by the geo-referenced line route plans made public by the local transport operators. For light rail and subway networks, the measurements between stops are derived from the estimated center of one station, following the geo-referenced route to the center of the next station. For bus networks, the measurement is conducted from the direction-specific stop along the geo-referenced route length to the next direction-specific stop.

iv) Identifying the Journey-Specific OR Throughout the Route

Fourth, the shift in the number of passengers along each recorded journey can be deduced by relying on the passenger exchange information at every stop (only for the datasets constituted by passenger exchange information). This information can then be transformed into the corresponding OR by placing it in relation to the scheduled vehicle capacity, hence, resulting in a percentage value.

v) Identifying the Averaged OR for each Line and Temporal Category

Fifth, having identified the OR across all the recorded journeys, an average OR is computed for all journeys within the same temporal category and at the same the normalized distance from the identified mobility center of gravity may be calculated. As a result, the averaged OR specific to each assessed line and direction for the three temporal categories referenced can be determined in relation to their recorded distance to the identified mobility center of gravity. The resulting ordered pairs (i.e. averaged OR and its normalized distance to the identified mobility center of gravity) become the building blocks of the OR function fitting process.

vi) Function Fitting

As a final step, the ordered distance-OR pairs for the same mode (i.e. bus, tram or light rail and subway) and temporal category (HVZ, NVZ and SVZ) generated in the previous step are plotted together. This allows for the function to be fitted to the scattered plots by means of a regression utilizing a linear model, as established by assumption number five discussed in subsection 4.3.2.

The fitness of the data pairs to the linear model constitutes a prime indicator for validating the proposed assumptions and the overall generalizations. However, before the statistical fitness of the resulting OR functions are evaluated, the functions must first validate all four assumptions so as to fully account for this *Section's* objectives and requirements outlined in for this part of the work (see subsection 3.2.1).

4.4. Scrutiny of Operational Information - OR Validation and Function Assembly

To validate the informative value of the isolated key determining variables and the relevance of the proposed assumptions, actual changes in vehicle-specific occupancy throughout the route of multiple public transport modes and networks must be tested and reviewed, as discussed in subsection 3.4.1. The scrutiny of operational information would ultimately allow corroborating the functionality and relevance of the assumptions for their utilization within the module to be derived in subsequent sections.

The assessment of actual operational information by means of the framework described in the previous subsection is discussed and exemplified throughout this subsection. The process would allow outlining the validity of the OR functions, as foreseen by the assumptions described in 4.3.2.

The scrutiny of the operational information for the validation of the assumptions is advanced in the following subsections. Initially, the study area is briefly defined in the following subtitle. Later, in subsection 4.4.1, the retrieved data from the study area is discussed. Thereafter, in subsection 4.4.2, the assembly of the mode and time-specific OR function through an exemplified implementation of the validation procedure detailed throughout subsection 4.3.3 is presented. Finally, a discussion regarding the resulting time and mode-specific OR functions derived from the subsection 4.4.2 is provided.

Definition of the Study Area

Within the framework of this *Section*, passenger counts from 6 different German cities and networks have been collected, namely, Esslingen, Frankfurt a.M., Hamburg, Ludwigsburg, Stuttgart and Wiesbaden. The cities have been selected on the basis of the availability of the required information, however, it has been strived to collect data from the three public transport modes, namely, bus, light rail and subway, as required in subsection 3.4.1.

In the subsequent paragraphs, the operating conditions and capabilities of the assessed public transport networks in the evaluated urban areas will be discussed. This is done to present a general overview of each one of the assessed networks and the nuances behind the operations of the collected datasets.

The information displayed in table 4.2 provides an overview of the operating conditions and magnitude of the six assessed public transport networks. This information enables a differentiation between specific features of each of the assessed networks during an entire year of operations (i.e. the number of public transport operators, the number of transported passengers, and places per kilometre).

Table 4.2 Annual overview of the transport structures across the six assessed public transport networks (VDV 2016)

City	Passengers (Tsd)	People-Km Tot. (Tsd)	Vehicle-Km (Tsd)	Place-Km (Mio)
Esslingen	N.D.	29.793	2.902	287
Frankfurt a.M.	249.729	1.688.356	39.361	10.192
Hamburg	473.825	2.642.296	98.800	16.478
Ludwigsburg	15.000	71.520	3.244	260
Stuttgart	183.829	760.864	32.131	5.893
Wiesbaden	55.362	276.810	12.404	1.014

Furthermore, the general qualities of the protracted networks and the explicit performance of each public transport mode must also be considered in detail. Therefore, table 4.3 highlights, with mode-specific granularity, the passenger transporting capabilities throughout one year of operations (i.e. 2016) in all six assessed networks.

Table 4.3 Annual overview of the public transport modes across the six assessed public transport networks (VDV 2016)

City		Esslingen	Frankfurt a.M.*	Hamburg*	Ludwigsburg	Stuttgart	Wiesbaden
Bus	Total Vehicles	58	290	1.345	66	352	242
	Vehicle-Km (Tsd)	2.902	12.607	82.845	3.244	16.451	12.404
	Places-Km (Mio)	287	1.230	6.492	260	1.237	1.014
Subway	Total Vehicles	-	-	238	-	-	-
	Vehicle-Km (Tsd)	-	-	12.486	-	-	-
	Places-Km (Mio)	-	-	8.245	-	-	-
Tram/ L. Rail	Total Vehicles	-	427	-	-	189	-
	Vehicle-Km (Tsd)	-	14.805	-	-	15.680	-
	Places-Km (Mio)	-	5.209	-	-	4.656	-

* The rest for both the Vehicle-Km and Places-Km is conducted via regional commuter rail (outside of scope)

From the information presented in tables 4.2 and 4.3, the heterogeneous nature of the network's capabilities for each public transport mode can be appreciated. Overall, by comparing this operational information, three strict patterns emerge.

First, the city of Hamburg stands out from the dataset with the largest number of passengers and place-km transported. Both of the considered public transport modes have significant transporting capabilities and are organized to share a similar load of the total generated trips. Moreover, among the assessed networks, Hamburg is the only city serviced by a subway system.

Second, the networks in Frankfurt a.M., Stuttgart and Wiesbaden can arguably be clustered together. All three networks have bus systems with similar capabilities, and each of them is able to supply around 1 billion places per kilometre on an annual basis. However, the networks of the first two cities are complemented by light rail systems with similar capabilities, which enables them to expand the annual hauling capabilities of the system by around 5 billion places per kilometre.

Third, the cities of Esslingen and Ludwigsburg have the smallest networks. Their bus systems are merely capable of supplying less than 25% of the places per kilometre as compared to the bus systems in the previous cluster and less than 4% when compared with Hamburg.

Conclusively, the public transport networks across the 6 urban areas display very eclectic data sets as they vary significantly in size and transporting capabilities. The inherent relationship between the extent of the urban functions and the aptitude of the reviewed transport capabilities must not be ignored. As a whole, this sample of diverse networks provides a substantial range of possible operating situations and therefore offers a worthy testing ground to challenge the assumptions guiding the establishment of the OR functions for the different public transport modes towards its respective validation.

4.4.1. Detail and Quality of the Retrieved Data

Having described the study area, the specific qualities of each dataset can be further discussed. It is important to bring attention to issues such as the magnitude, limitations and overall ability of each network to abide by the requirements discussed in subsection 4.3.3.

The retrieved datasets consist of passenger exchange records for the timetabled journeys along 25 different lines for all the three required public transport modes (see subsection 3.4.2), corresponding to one entire day of operations on a working day during the schooling season in the year 2016. What is more, from the information retrieved, it is possible to decipher the actual occupancy of a vehicle for each specific journey. Therefore, the granularity of the information retrieved fulfills the requirements described in the previous subsection.

Table 4.4 details the structure, the magnitude, and the surveyed season of the assessed lines in all six networks. A total of 25 lines across all six networks have been assessed and the spatial structure of these lines can be further appreciated in figure 4.3.

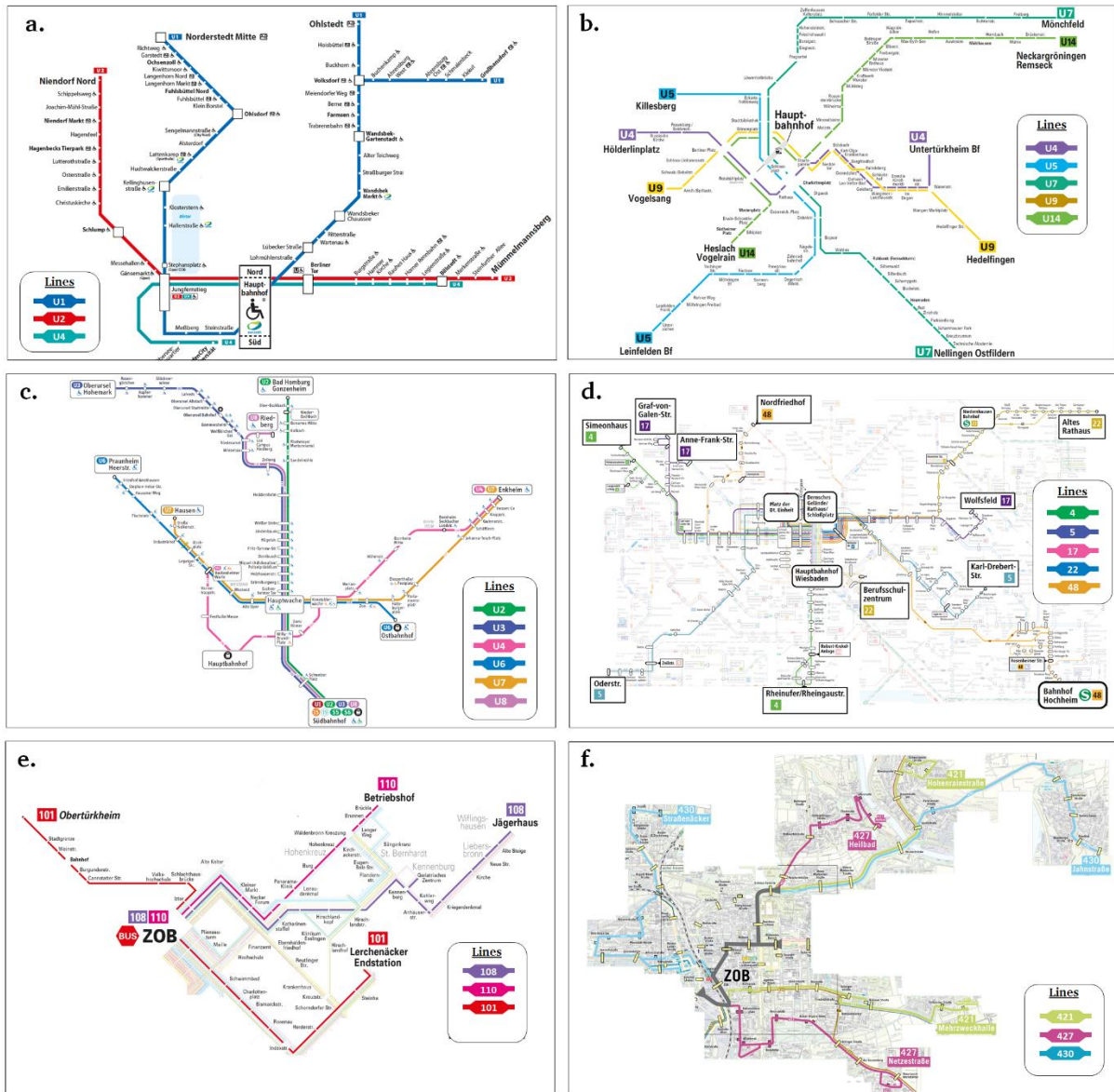

Figure 4.3 Assessed public transport lines within every public transport network: a. Hamburg (HVV 2016a); b. Stuttgart (VVS 2016a); c. Frankfurt a.M. (RMV 2016a); d. Wiesbaden (ESWE 2016a); e. Esslingen (VVS 2016b); f. Ludwigsburg (VVS 2016c)

These lines have been chosen on the basis of their total length and their ability to connect the city center with the outskirts of their respective urban areas. Therefore, lines with both radial and diametrical qualities were preferred over those with circular characteristics due to their overall structure and the amount of information that can be extracted from these line typologies (see subsection 2.4.4).

Table 4.4 provides in-depth information about the six networks that have been studied and the 25 assessed lines that constitute the retrieved data set of this study. In table 4.4, the first three columns provide information regarding the studied network, mode and the operating number of the assessed line. Additionally, the length of the line and the number of stops where passenger exchange information was recorded is detailed in the fourth and fifth columns of table 4.4. Moreover, the number of journeys for which passenger exchange information was recorded and the surveyed period is detailed in the sixth and seventh columns of table 4.4. Finally, the source of the information is provided in the last column.

Table 4.4 Assessed public transport networks, lines, modes and data set sources (by author)

Urban Area	Mode	Recorded Lines (N°)	Approx. Line Length (km)	Amount of Stops per Line (N°)	Retrieved N° Journeys (Per Direction)**	Surveyed Period	Source
Esslingen	Bus	101	9	18	77 / 75	Autumn 2016 Mo – Fr	VVS (2016d)
		108	6	15	56 / 61		
		110	6	13	62 / 64		
Frankfurt a.M.	Light Rail	2	17	21	139 / 136	Autumn 2016 Tu, We, Th	traffiQ (2016)
		3	19	28	72 / 71		
		4	11	15	171 / 171		
		6	9	15	128 / 130		
		7	12	20	124 / 125		
Hamburg	Subway	1	51	46	221 / 214	Spring 2016 Mo – Fr	HVV (2016b)
		2	26	25	202 / 216		
		4	13	11	112 / 113		
Ludwigsburg	Bus	421	10	21	86 / 83	Spring 2016 Mo – Fr	VVS (2016d)
		427	9	20	86 / 82		
		430	14	26	56 / 58		
Stuttgart	Light Rail	4	10	22	111 / 113	Autumn 2016 Mo – Fr	VVS (2016d)
		5	16	22	56 / 55		
		7	26	36	109 / 109		
		9*	14	28	107 / 107		
		14*	22	33	104 / 105		
Wiesbaden	Bus	4	10	30	129 / 127	School Season 2016 Mo-Fr	ESWE (2016b)
		5	14	34	92 / 93		
		17	10	27	79 / 86		
		22	20	38	35 / 22		
		48	25	39	12 / 44		

* The data for Lines 9 and 14, were collected during construction works after May of 2016.

** The information in this column is provided for every direction of travel X or Y, as: X/Y.

The number of recorded journeys across all assessed networks can be determined by the total number of recorded stops for each line (fifth and sixth columns in table 4.4), providing a picture of each network's magnitude. For example, across all of Stuttgart's light rail lines, more than 130.000 occupancy data points have been retrieved. While this is a good start, an even better appreciation of the overall magnitude of the retrieved information will be possible during the implementation of the validation procedure.

It must be clarified that for the assessed lines in Frankfurt a.M., the information for all light rail lines in the city is limited to specific cross-sections across its network and the passenger exchange information has been only surveyed at specific stops along a vehicle's route (see table 4.5). As such, it stands out as an exception to the general structure of the datasets described above.

Table 4.5 Surveyed stops per every assessed line - Frankfurt a.M. Light Rail (traffiQ 2016)

Line N°	Public Transport Stop
2	Kalbach; Heddernheim; Eschenheimer Tor
3	Niederursel; Heddernheim; Eschenheimer Tor
4	Schäfflestraße; Merianplatz; Willy-Brandt-Platz; Festhalle/Messe
6	Industriehof; Alte Oper; Zoo
7	Industriehof; Alte Oper; Zoo; Schäfflestraße
8	Niederursel; Heddernheim; Eschenheimer Tor

On another note, the passenger exchange information data sets from all networks have been captured through the APCS surveying technique, with the exception of Frankfurt a.M.'s light rail lines. In the case of Frankfurt a.M., information was gathered by means of manual passenger counts at the stops displayed in table 4.5.

All five datasets captured through APCS were corrected and compensated as detailed in (VDV 2018). The correction and compensation procedure is necessary since APCS generates inherent errors as it: a) is not able to differentiate between passengers boarding and alighting from the vehicle to facilitate passenger exchange at a given stop; b) fails to recognize passengers that remain in the vehicle at the last station during the turn-around time; and c) is occasionally subject to instrumental miscounts. The maximum net error range allowed between sampling and measurement errors is 5%, which is also the limit accepted for the manual surveying techniques (VDV 2018). As a result, the errors of the retrieved datasets should fall within the explained surveying accuracy standards (i.e. $\pm 5\%$).

Example of Dataset Structure and Granularity

To exemplify the structure of the retrieved information, table 4.6 circumscribes the journey-specific granularity during a one-hour window for 7 of the 111 journeys retrieved from Stuttgart's light rail line "U4" with the direction to "Hölderlinplatz".

For every journey, which is identified by its starting time-stamp, the table details the recorded vehicle-specific occupancy (i.e. including both standing and seating passengers) between two particular stops. It records this value at the arriving stop before the vehicle's doors are opened for passenger exchange. For example, for the journey starting at 07:33 between the stops "Untertürkheim" and "Wasenstraße" the vehicle recorded an occupancy of 52 passengers at the stop "Wasenstraße". Since "Untertürkheim" is the line's origin station it carries no information.

Table 4.6 Passengers transported between stops - Stuttgart's light rail line "U4" direction "Hölderlinplatz" (VVS 2016d)

Stop Name	<i>Maximum Vehicle Capacity: 246 Passengers</i>						
	Journey Starting Time						
	<i>(Total Number of Passenger in the Vehicle)</i>						
	07:33	07:43	07:53	08:03	08:13	08:23	08:33
Untertürkheim	--	--	--	--	--	--	--
Wasenstraße	52	26	32	54	37	29	43
Inselstraße	49	31	34	62	47	38	55
Im Degen	58	34	46	68	51	51	56
Brendle (Großmarkt)	62	30	53	72	49	56	63
Landhausstraße	74	28	53	74	49	56	64
Gaisburg	87	34	62	74	55	62	70
Ostheim Leo-Vetter-Bad	121	65	80	100	72	127	116
Ostendplatz	189	87	98	119	78	167	130
Bergfriedhof	214	105	144	139	94	206	140
Karl-Olga-Krankenhaus	213	114	142	162	93	210	137
Stöckach	226	122	149	164	89	225	131
Neckartor	169	103	139	144	97	164	113
Staatsgalerie	165	110	157	146	97	167	111
Charlottenplatz	122	102	163	149	97	167	111
Rathaus	107	108	165	144	128	212	137
Stadtmitte	97	96	155	111	125	184	119
Berliner Platz (Hohe Straße)	59	62	103	70	69	150	74
Berliner Pl. (Liederhalle)	33	55	59	35	55	121	69

Stop Name	<i>Maximum Vehicle Capacity: 246 Passengers</i>						
	<i>Journey Starting Time</i>						
	<i>(Total Number of Passenger in the Vehicle)</i>						
	07:33	07:43	07:53	08:03	08:13	08:23	08:33
Rosenberg-/Seidenstr.	30	54	47	33	55	112	62
Russische Kirche	18	28	10	18	43	71	36
Hölderlinplatz	7	17	5	11	34	47	18

The structure of the vehicle-specific occupancy described by table 4.6, is consistent across all networks except for Frankfurt a.M.'s light rail information, Hamburg's subway lines and Wiesbaden's bus lines. For the first two cases, the vehicle-specific occupancy must be constructed from the passenger exchange information (i.e. the number of boarding and alighting passengers), and in the case of Wiesbaden, the information only allows for the identification of the utilized vehicle types for each journey.

In the case of Hamburg, the passenger exchange information provides a reasonable picture of the vehicle-specific occupancy between stations (see table 4.6.) without major errors due to the already corrected and compensated values. Only 3.1% of the total recorded journeys (33 journeys) resulted in negative passenger occupation values. The negative occupation was re-set to zero at the station where this error was first identified.

In the case of Frankfurt a.M., since data is only available for specific cross-sections, information on the vehicle-specific occupancy is limited for all lines. The information is only available at surveyed stops. However, by considering passenger exchange information, it is also possible to identify the number of passengers leaving the surveyed station and, thus, the vehicle-specific occupancy at the next stop.

In Wiesbaden, it is only possible to identify the utilized vehicle types per journey and the maximum vehicle capacities detailed in table 2.5 displayed in subsection 2.4.4.

Table 4.6 provides an example of the general structure of processes information. The resulting journey-specific occupancy records between stops constitute the core input for assembling the mode and time-specific OR functions.

4.4.2. Example of the Assembly of the Mode and Time Specific OR Functions

Following the procedure described in subsection 4.3.3, the respective OR function can now be assembled. This subsection describes the handling of all retrieved information for all six steps of the validation procedure. For the purposes of this example, the general OR assembly function and validation are conducted with the data recorded from Stuttgart's light rail line.

Establishing the mobility center of gravity

When establishing the mobility centers of gravity, a balance should be struck between identifying the decisive cross-sections and acknowledging the relevance of further mobility structures within the network. Both of these considerations must be evaluated simultaneously in order to recognize the locations of converging elements around the most relevant areas for local urban mobility. This allows the proficient identification of mobility centers of gravity.

To identify decisive cross-sections, the flow of passengers throughout the different stops must be summarized, over the course of an entire day of operations. The summarized passenger flows in table 4.7 represent the number of passengers arriving at the recorded stop over the course of the

day, and the values displayed at a given stop can provide insight into the relevant inflow of passengers or the relevant outflow from the previous stop.

Table 4.7 displays the daily passenger flows at all the stops for Stuttgart's light rail line "U14" in both directions of travel and identifies the cross-sections with the decisive passenger flow. The colour in the table highlights the identified passenger flow for that specific stop compared to the maximum (red) and minimum (green) value identify for all stops in the same direction of travel. The cross-section identification procedure should be conducted for all the assessed lines in the Stuttgart light rail network and likewise throughout all assessed networks.

Table 4.7 Daily passenger flows per stop - Stuttgart's light rail line "U14" for both directions of travel (by author)

Station	Direction – Heslach* (passengers/day)	Direction – Neckargröningen* (passengers/day)
Neckargröningen Remseck	---	1467
Aldingen Brückenstraße	1416	1554
Aldingen Mühle	1673	1994
Aldingen Hornbach	2168	2345
Mühlhausen	2626	3296
Auwiesen	3425	3576
Hofen	3770	4126
Max-Eyth-See	4407	4661
Wagrainäcker	4845	4710
Elbestraße	5021	5146
Freibergstraße	5463	5757
Münster Rathaus	6040	6569
Münster Viadukt	6780	6727
Kraftwerk Münster	6925	6893
Mühlsteg	7110	7325
Rosensteinbrücke	7592	7358
Wilhelma	7636	7912
Mineralbäder	7962	8033
Metzstraße	7898	8667
Stöckach	8573	9383
Neckartor	8585	10187
Staatsgalerie	9145	10189 (OUT)
Hauptbf. (Arnulf-Klett-Pl.)	9354 (IN)	8925
Börsenplatz	8881	8776
Berliner Pl. (Liederhalle)	8586	8119
Berliner Platz (H. Straße)	7438	8157
Stadtmitte	7692	9545 (IN)
Österreichischer Platz	9292 (OUT)	7896
Marienplatz	7998	5256
Erwin-Schoettle-Platz	5095	3348
Bihlplatz	3324	1838
Südheimer Platz	1764	1165
Heslach Vogelrain	955	---

*The colour scale tracks the changes in the passenger flow per stop where Green represents the lowest and Red the highest.

Since the establishment of the mobility center of gravity must be done in parallel with the consideration of further mobility structures, the identification of the decisive cross-sections for all assessed lines in Stuttgart must be contrasted with their position in the public transport mobility environment, as displayed in figure 4.4 (b.). By taking this approach, not only is the importance

of the sections with the strongest flow of passenger evaluated but so is the way the flow develops within the context of the wider public transport network.

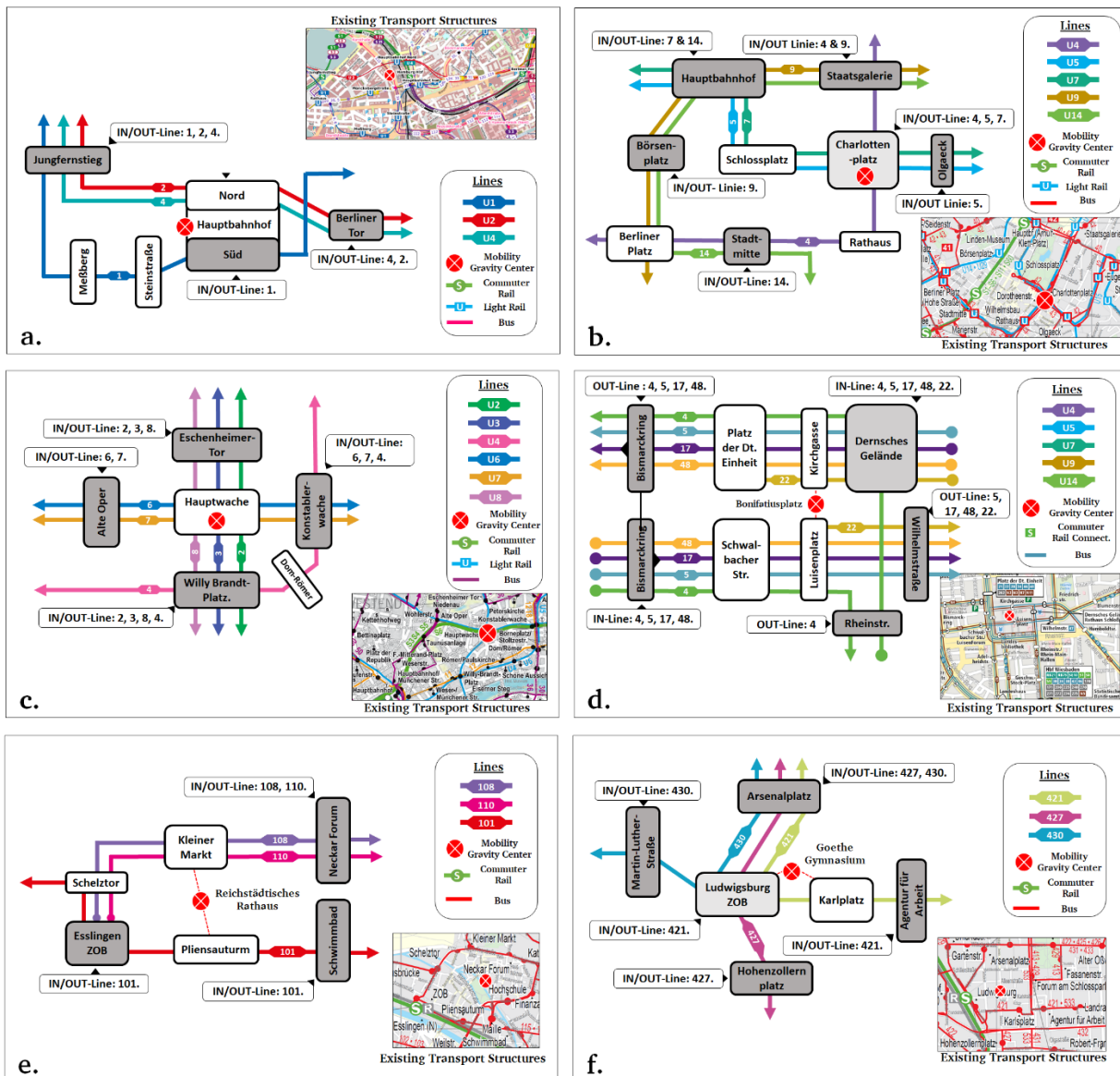

Figure 4.4 Schematic representation of the decisive cross-sections and the location of the mobility center of gravity for every assessed public transport network: a. Hamburg (HVV 2016c); b. Stuttgart (VVS 2016e); c. Frankfurt a.M. (RMV 2016b); d. Wiesbaden (ESWE 2016c); e. Esslingen (VVS 2016f); f. Ludwigsburg (VVS 2016c), all modified by author.

Table 4.8 depicts the results of the comparison analysis displaying the daily passenger flows at the cross-sections identified as decisive. Since the table proficiently distinguishes between the line's directions of travel, it is possible to identify the difference between incoming and outgoing passenger flow in the converged cross-section area. The difference between the accounted inflow and outflow of passengers is as low as 0.9 %.

By overlaying information from table 4.8 with figure 4.4 (b.) and balancing this with the traversing flow of passengers, the mobility center of gravity according to the retrieved data for the public transport network of Stuttgart is located at the station "Charlottenplatz". Most importantly, the identified mobility center of gravity stands as a relevant intersecting location between passengers moving within the investigated urban area from east-west and north-south as well as for the significant intermodal connection between the light rail and the bus systems.

Table 4.8 Daily passenger flows at the decisive cross-sections for all assessed lines - Stuttgart's light rail (by author)

Line Number	Cross-Section (Inflow)		Cross-Section (Outflow)	
	Station	Passengers/day	Station	Passengers/day
U4 - Dir. Hölderlinplatz	Staatsgalerie	7140	Charlottenplatz	7227
U4 - Dir. Untertürkheim	Charlottenplatz	7316	Staatsgalerie	7136
U5 - Dir. Leinfelden	Charlottenplatz	4014	Olgaeck	4861
U5 - Dir. Killesberg	Olgaeck	5551	Charlottenplatz	4754
U7 - Dir. Nellingen	Hauptbahnhof	11703	Charlottenplatz	14046
U7 - Dir. Mönchfeld	Charlottenplatz	13801	Hauptbahnhof	11867
U9 - Dir. Botnang	Staatsgalerie	9580	Börsenplatz	7548
U9 - Dir. Hedelfingen	Börsenplatz	6451	Staatsgalerie	8357
U14 - Dir. Heslach	Hauptbahnhof	9354	Stadtmitte	9292
U14 - Dir. Remseck	Stadtmitte	9545	Hauptbahnhof	10189
Difference = 0.9 (%)	TOTAL	84455	TOTAL	85277

The identical procedure is then conducted for all the assessed public transport networks. The identification of their decisive cross-sections, an evaluation of their existing mobility situation and the establishment of their mobility center of gravity can be appreciated in figures 4.4 (a-f).

Identifying the Three Temporal Categories (HVZ, NVZ and SVZ)

The three temporal categories should be distinguished by clustering the dominant hourly flow of passengers at the decisive cross-sections and the number of journeys transpired during the respective interval as a coordinated pair.

Before performing the iterative clustering approach, the passenger flows and the number of journeys must be summarized into the respective one-hour intervals. The respective passenger flow at the decisive cross-section is assigned to a temporal interval on the basis of the journey's starting time-stamp. Therefore, for every line and direction, the starting time-stamp is decisive for circumscribing a particular journey and the passenger flow within a temporal interval. In this way, the respective information pairs (X, Y) used in the clustering are created.

Figure 4.5 provides a summarized overview of Stuttgart's light rail passenger - in and outflows from the center and the number of journeys for every hourly interval throughout the entire operational day. Moreover, the figure also supports the identification of the instant at which the outflow of passengers becomes dominant over the inflow of passengers; in this case, this occurrence begins at 12:00 hrs.

The ordered pairs "X, Y" are then generated, where X represents the number of journeys, and Y total dominant passenger flow within the hourly interval. These must subsequently be clustered into one of the temporal categories (i.e. HVZ, NVZ and SVZ). As described in subsection 4.3.3, the clustering method is focused on identifying the minimum square difference between the ordered pairs and the resulting centroids specific to every temporal category.

To initiate the clustering process (clustering step 2 - see subsection 4.3.3), manual clustering results in the identification of a preliminary set of centroids for each temporal category. As an example, the last row of the table in figure 4.5 displays the outcome of the preliminary clustering for Stuttgart's light rail, where the temporal categories are recognized as: SVZ=1; HVZ=2 and NVZ=3. The resulting centroids (i.e. the average within each temporal category) for the manual clustering result in: $\bar{X}_1 = 31.5$, $\bar{Y}_1 = 1147.5$; $\bar{X}_2 = 55.25$, $\bar{Y}_2 = 8204.25$ and $\bar{X}_3 = 51.45$, $\bar{Y}_2 = 4859$.

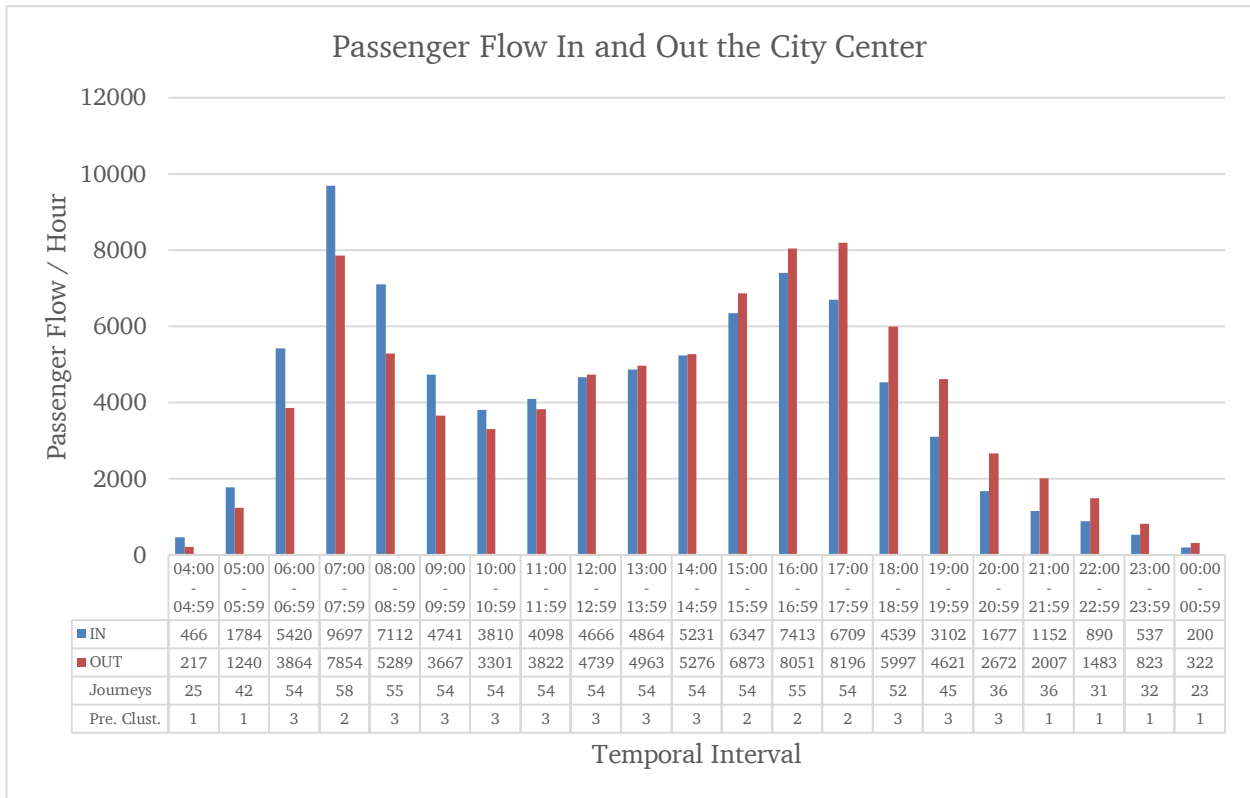

Figure 4.5 Summarized passenger flow at the decisive cross-sections for all assessed Stuttgart’s light rail lines (by author)

Following the preliminary clustering, the actual clustering process can be conducted (see subsection 4.3.3). As an example, table 4.9 summarizes the iterative process to find the adequate temporal cluster for the interval between 8:00 hrs. - 8:59 hrs.; where the ordered pair “X, Y” stands as: X = 55 (number of journeys), and Y = 7112 (passengers/hr) (see figure 4.5). All iterations of the clustering process must be conducted simultaneously for all intervals, however, it should be noted that this example only displays the results for one single interval.

Table 4.9 Example of the iterative clustering process for a single interval - Stuttgart’s light rail (by author)

Time Interval - 08:00-08:59				
Iteration	Manual Clustering	1st Iteration	2nd Iteration	Calculation (as in 4.3.3.)
Starting Cluster	3	2	2	
Centroid \bar{X}_1	31.5	32.14	32.14	2
Centroid \bar{Y}_1	1147.5	1365.29	1365.29	
Squared Diff. w/Centroid 1	35575812.5	33025247.5	33025247.5	3
Centroid \bar{X}_2	55.25	55.2	55.2	2
Centroid \bar{Y}_2	8204.25	7985.8	7985.8	
Squared Diff. w/Centroid 2	1193010.13	763526.48	763526.48	3
Centroid \bar{X}_3	51.45	52.78	52.78	2
Centroid \bar{Y}_3	4859	4851.67	4851.67	
Squared Diff. w/Centroid 2	5076021.57	5109111.72	5109111.72	3
min. squared Diff.	1193010.13	763526.48	763526.48	4
New Cluster:	2	2	2	
Total min Diff:	13608142.40	13037023.40	13037023.40	5

After the clustering example presented in table 4.9, the iterative process changed the studied interval from its initial assigned cluster (i.e. NVZ) to be part of the HVZ as its best-fitting temporal category.

The results of the iterative clustering process for all the temporal intervals across Stuttgart’s light rail lines can be appreciated in figure 4.6. The figure displays the plot of ordered pairs and the resulting centroids for all three temporal categories of the identified clusters.

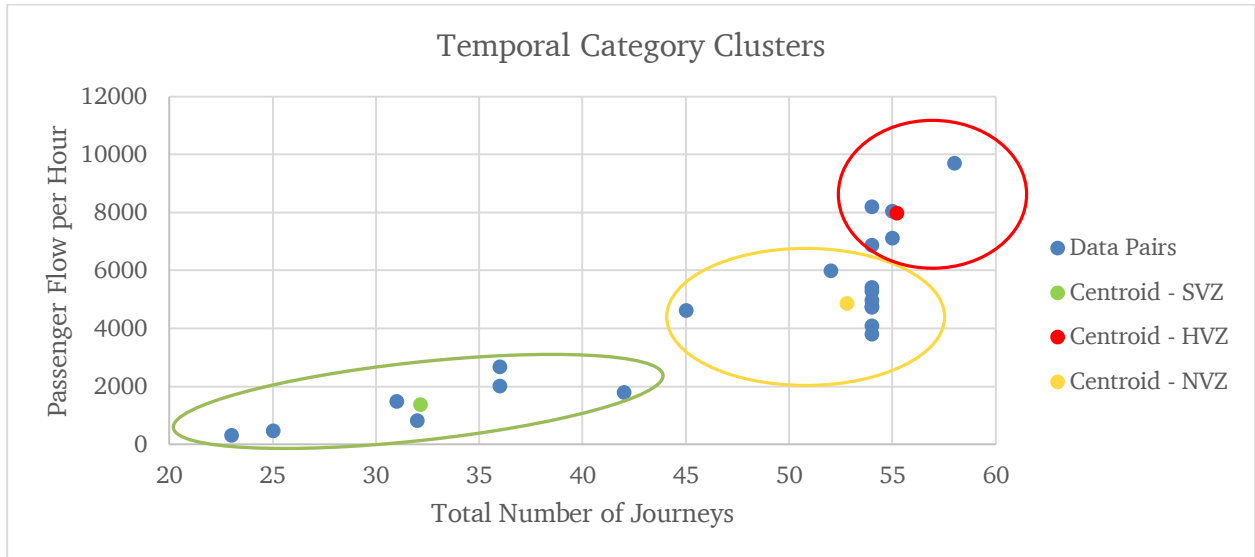

Figure 4.6 Temporal category clusters for Stuttgart’s light rail lines (by author)

Ultimately, the generated clusters uphold the distribution of the three temporal categories throughout the operational day for the assessed network, as summarized in figure 4.7. Of course, the same procedure must then be conducted for all assessed public transport networks.

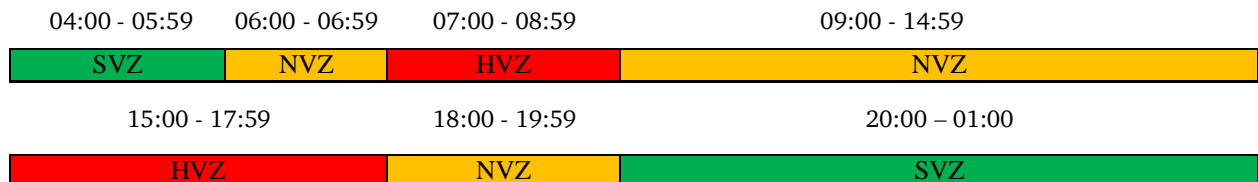

Figure 4.7 Summarized temporal clusters for Stuttgart’s light rail lines (by author)

Route Length Normalization

The normalization of the different route lengths requires two specific tasks: the identification of the stop lying closest to the mobility center of gravity for each line as well as the direction of travel and the computation of the total route lengths, including the existing route variations.

The identification of the stop lying closest to the city center must be recognized specifically for each direction of travel. All stops around the mobility center of gravity are checked to verify their proximity, and the one which lays the closest to the mobility center of gravity defines the location in which the respective line is to be truncated (radial lines) or divided (diametrical lines).

Expanding on the example network, the identification of the relevant stops for Stuttgart’s light rail lines is conducted with respect to the identified center in the “Charlottenplatz”. From figure 4.4 (b.), it is possible to appreciate that lines U4, U5 and U7 in both directions include the center of gravity as a stop; thus, their distance to the point is considered equal to zero. However, Lines U9

and U14 are essentially identical within their routes across the urban core since both of their directions do not traverse the stop “Charlottenplatz”. As such, these require a deeper assessment to identify their closest stop to the mobility center of gravity.

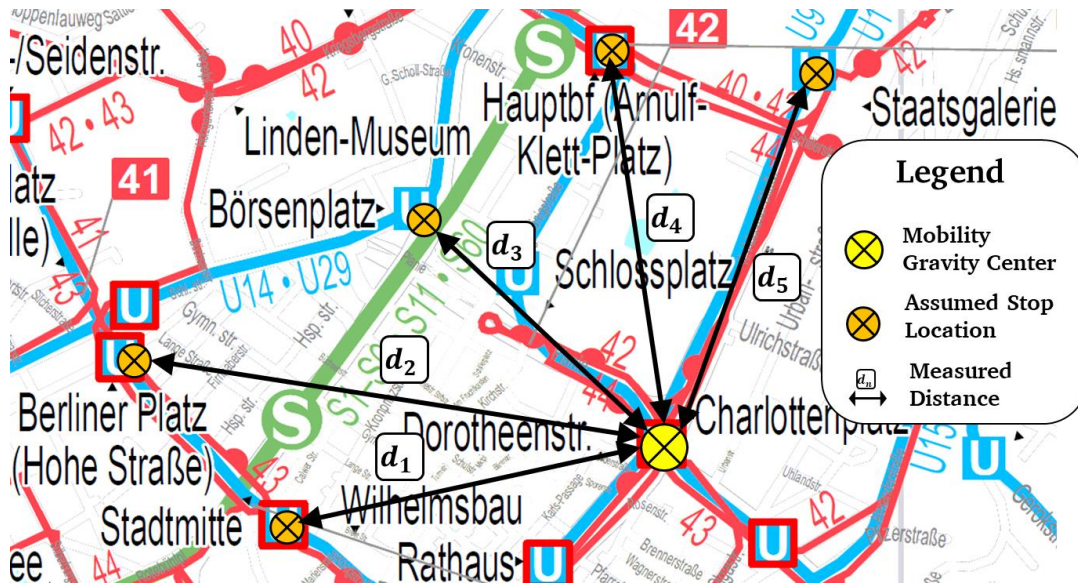

Figure 4.8 Air distances measured from all neighbouring public transport stops to the mobility center of gravity for Stuttgart’s light rail lines “U9” and “U14” (by author)

Table 4.10 includes the results for the identification of the stop laying the closest to the mobility center of gravity for both the U9 and U14 lines. This process that can be furthered referenced by observing the local spatial qualities in figure 4.8 entails selecting the stop with minimum actual distance (i.e. air distance multiplied by the detour factor, see subsection 3.6.1) to the identified mobility center of gravity. Table 4.10 reveals that the closest stop to Charlottenplatz is the “Börsenplatz”.

Once the relevant stations have been identified, and in the view of the fact that all of Stuttgart’s assessed lines are diametrical (see figure 4.3 b.), the recognized station becomes the location in which the diametrical lines are divided into two radial lines. This must be considered in the handling of all diametrical lines throughout all the assessed public transport modes and networks.

Table 4.10 Identification of the mobility Center of gravity - Stuttgart’s light rail (by author)

Assessed Stop	Figure (4.8) d_n	Measured Air Distance (m)	Detour Factor $[U_F]$ (m)	Total Distance (m)
Stadtmitte	d_1	800	1.13	904.00
Berliner Platz (H.S.)	d_2	1070	1.12	1198.40
Börsenplatz	d_3	650	1.14	741.00
Hauptbahnhof	d_4	810	1.13	915.30
Staatsgalerie	d_5	800	1.13	904.00

The existence of diverging routes of the different lines within the operational day must be recognized for the specific route lengths to be measured. The journey-specific structure of the retrieved data, already described throughout subsection 4.4.2, is instrumental in identifying the existence of diverging routes for the assessed lines.

As an example, the case of Stuttgart’s light rail line U9 is considered in detail. Within the line’s basic scheduled operations, the data identifies the standard vehicle circulation to have the station “Vogelsang” as the starting/ending station. Nonetheless, around 1/3 of the line’s scheduled

journeys, mostly during the identified HVZ, have the station “Botnang” as the origin/objective. Therefore, the identified route variants must have their route lengths computed separately.

Once the route variants are identified, the computation of the total route lengths can be conducted. Following the measuring processes described in subsection 4.3.3., the distance between the stops is then registered and accumulated.

The accumulated distance between stops and the respective normalization is displayed in table 4.11. In this example, with the U9 as a diametrical line, it is divided into two radial lines at the identified mobility center of gravity for both route variants. Due to the line’s characteristics, three total route lengths can be identified; these values constitute the foundation for normalizing the accumulated distances (i.e. equal to 1).

Table 4.11 Normalized distance - Stuttgart’s light rail line "U9" for both directions of travel (by author)

Stop	Variant 1		Variant 2	
	Accumulated Distance (m)	Distance (Normalized)	Accumulated Distance (m)	Distance (Normalized)
Hedelfingen	9140	1.00	9140	1.00
Hedelfinger Straße	8290	0.91	8290	0.91
Wangen Marktplatz	7680	0.84	7680	0.84
Wasenstraße	8100	0.89	8100	0.89
Inselstraße	6680	0.73	6680	0.73
Im Degen	6290	0.69	6290	0.69
Brendle (Großmarkt)	5630	0.62	5630	0.62
Wangener-L.S.	5300	0.58	5300	0.58
Schlachthof	4640	0.51	4640	0.51
Raitelsberg	4150	0.45	4150	0.45
Bergfriedhof	3710	0.41	3710	0.41
Karl-Olga-Krankenhaus	3430	0.38	3430	0.38
Stöckach	2900	0.32	2900	0.32
Neckartor	2390	0.26	2390	0.26
Staatsgalerie	1960	0.21	1960	0.21
Hauptbf (Arnulf-Klett-Pl.)	1430	0.16	1430	0.16
Börsenplatz	740	0.08	740	0.08
Börsenplatz	740	0.13	740	0.24
Berliner Pl. (Liederhalle)	1290	0.23	1290	0.42
Schloss-/Johannesstr.	1860	0.33	1860	0.60
Schwab-/Bebelstraße	2410	0.42	2410	0.78
Arndt-/Spittastraße	2730	0.48	2730	0.88
Vogelsang	3090	0.54	3090	1.00
Herderplatz	3520	0.62		
Lindpaintnerstraße	4180	0.73		
Beethovenstraße	4560	0.80		
Millöckerstraße	4940	0.87		
Eltinger Straße	5320	0.93		
Botnang	5700	1.00		

The same route normalization procedure is conducted for all the assessed public transport networks across all the protracted lines.

Identifying the Journey-Specific OR Throughout the Route

By means of the total number of passengers transported between stations and the scheduled maximum vehicle capacity (as displayed in table 4.6), the OR for every scheduled journey

throughout its route can be determined. The OR is calculated by placing the registered vehicle-specific occupancy in relation to the scheduled vehicle's capacity and represented as a percentage value. The identified OR for the vehicle is then referenced as its accumulated normalized distance intrinsically measured in correspondence with the identified mobility center of gravity.

To exemplify the identification of the journey-specific OR throughout a vehicle's referenced route, table 4.12 displays a set of spatially referenced OR. The presented information derives from the vehicle-specific occupancy values presented in table 4.6 for Stuttgart's light rail line U4 in direction to "Hölderlinplatz", and places them in relation to the scheduled vehicle capacity, in this case: 246 passengers. Moreover, both the accumulated and normalized distance for the protracted line, which has no variants, are presented so as to exemplify the spatial referencing of the OR as identified in the previous subtitle.

Table 4.12 Referenced journey-specific OR Development - Stuttgart's light rail line "U4" direction "Hölderlinplatz" (by author)

Stop Name	<i>Maximum Vehicle Capacity: 246 Passengers</i>							<i>Accum. Distance (m)</i>	Norm.
	<i>Vehicle-Specific Occupancy - OR (%)</i>								
	07:33	07:43	07:53	08:03	08:13	08:23	08:33		
Untertürkheim	--	--	--	--	--	--	--	6585	1.00
Wasenstraße	21.14	10.57	13.01	21.95	15.04	11.79	17.48	5885	0.89
Inselstraße	19.92	12.60	13.82	25.20	19.11	15.45	22.36	5545	0.84
Im Degen	23.58	13.82	18.70	27.64	20.73	20.73	22.76	5105	0.78
Brendle (Großmarkt)	25.20	12.20	21.54	29.27	19.92	22.76	25.61	4445	0.68
Landhausstraße	30.08	11.38	21.54	30.08	19.92	22.76	26.02	4135	0.63
Gaisburg	35.37	13.82	25.20	30.08	22.36	25.20	28.46	3595	0.55
Ostheim Leo-Vetter-Bad	49.19	26.42	32.52	40.65	29.27	51.63	47.15	3235	0.49
Ostendplatz	76.83	35.37	39.84	48.37	31.71	67.89	52.85	2905	0.44
Bergfriedhof	86.99	42.68	58.54	56.50	38.21	83.74	56.91	2545	0.39
Karl-Olga-Krankenhaus	86.59	46.34	57.72	65.85	37.80	85.37	55.69	2265	0.34
Stöckach	91.87	49.59	60.57	66.67	36.18	91.46	53.25	1735	0.26
Neckartor	68.70	41.87	56.50	58.54	39.43	66.67	45.93	1225	0.19
Staatsgalerie	67.07	44.72	63.82	59.35	39.43	67.89	45.12	795	0.12
Charlottenplatz	49.59	41.46	66.26	60.57	39.43	67.89	45.12	0	0.00
Rathaus	43.50	43.90	67.07	58.54	52.03	86.18	55.69	325	0.11
Stadtmitte	39.43	39.02	63.01	45.12	50.81	74.80	48.37	1085	0.37
Berliner Platz (H.S.)	23.98	25.20	41.87	28.46	28.05	60.98	30.08	1455	0.50
Berliner Pl. (Liederhalle)	13.41	22.36	23.98	14.23	22.36	49.19	28.05	1625	0.55
Rosenberg-/Seidenstr.	12.20	21.95	19.11	13.41	22.36	45.53	25.20	2055	0.70
Russische Kirche	7.32	11.38	4.07	7.32	17.48	28.86	14.63	2475	0.84
Hölderlinplatz	2.85	6.91	2.03	4.47	13.82	19.11	7.32	2935	1.00

The overall structure presented in table 4.12 is consistent across all the assessed public transport networks and lines, referencing perceptual OR information for every journey within the normalized route length and measured in correspondence to the identified mobility center of gravity.

Identifying the Averaged OR for Each Line and Temporal Category

Having referenced the journey-specific development of the OR throughout each of the routes of the assessed lines in correspondence to the identified mobility centers of gravity, the OR of every line can be averaged for all journeys contained within the same temporal category and spatial referencing (i.e. normalized route length).

Building upon the example of Stuttgart's light rail line U4 with direction "Hölderlinplatz", table 4.13 contains the averaged OR for all journeys belonging to the same temporal category and

normalized route length. The resulting structure can be understood as a line-specific and direction-specific set of ordered pairs (i.e. averaged OR and referenced normalized distance) for each of the three temporal categories.

The resulting ordered pairs can be made specifically for every temporal category and mode by expanding upon the structure displayed in table 4.13, and by using this as a basis for all the protracted lines within the same networks and subsequently to other networks where the same public transport mode have been assessed. Finally, at this stage, the spatiotemporal qualities of the collected public transport demand information for all lines, directions, line variants and networks are identified and ready for final assessment.

Table 4.13 Averaged journey-specific OR - Stuttgart's light rail line "U4" direction "Hölderlinplatz" (by author)

Averaged OR (%)			Normalized Distance
SVZ	HVZ	NVZ	
3.07	13.62	8.02	0.89
3.48	16.04	9.60	0.84
3.68	18.15	10.99	0.78
4.00	19.21	11.87	0.68
3.88	19.82	12.78	0.63
4.10	21.67	13.96	0.55
5.42	28.59	18.73	0.49
6.49	34.13	21.25	0.44
8.93	41.37	27.49	0.39
9.46	43.53	28.56	0.34
10.03	44.93	29.86	0.26
8.90	37.83	26.45	0.19
8.74	38.68	27.56	0.12
8.35	36.68	26.87	0.00
8.30	39.44	27.20	0.11
9.30	39.96	25.92	0.37
10.26	33.86	20.72	0.50
9.97	29.56	19.44	0.55
10.10	27.94	18.87	0.70
7.92	21.80	14.83	0.84
5.81	10.68	9.65	1.00

Figure 4.9 contains the ordered pairs for the expanded assessment, thus, it includes the processed information of all the assessed public transport modes and temporal categories (see table 4.4). As a result, the plotted ordered pairs condense the averaged OR for all the assessed lines and line variants that constituted the dataset, namely, subway, light rail and bus networks.

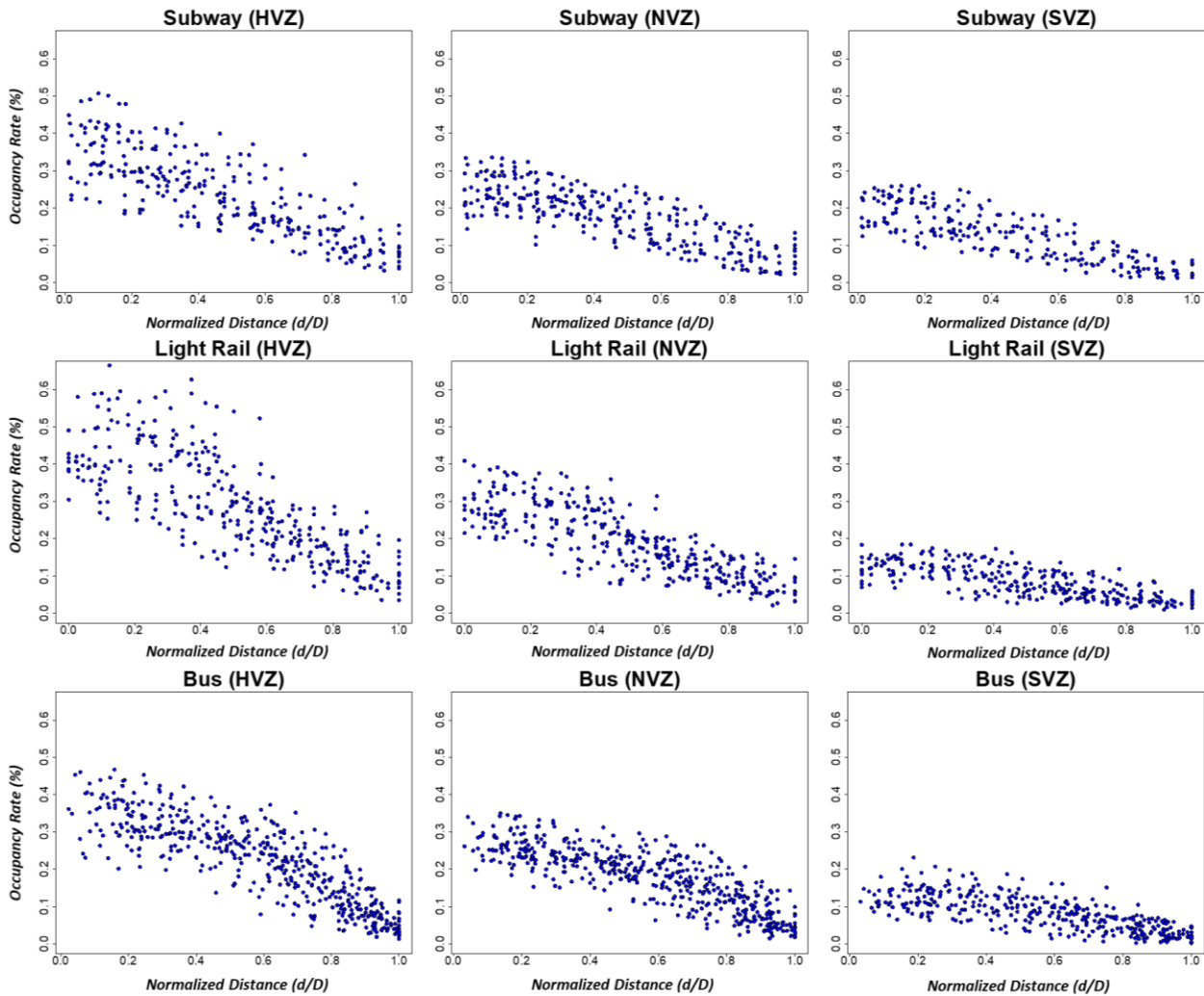

Figure 4.9 Averaged OR for all assessed lines and modes of transport for every temporal category (by author)

Function Fitting

At this stage in the validation process, the obtained ordered pairs for every temporal category and public transport mode are plotted together to conduct the function fitting process (as in figure 4.9). The function fitting process would intrinsically support the validation of the assumptions derived throughout subsection 4.3.2, regarding their ability to logically explain the measured changes in the OR of a public transport vehicle along its route.

As discussed in subsection 4.3.3, the regression should be conducted with a linear model, fitting a linear function to the ordered pairs. By observing the layout of the plotted ordered pairs across all three temporal categories (e.g. figure 4.9) and all three investigated public transport modes, the assumed linear model stands as being still the appropriate approach to continue the validation process. Consequently, the resulting ordered pairs across all modes and temporal categories are fitted with a linear function of the form: $y = a + x * -b$.

The results of the linear regression on the different data sets can be observed in figure 4.10, where the fitted functions for all the three modes of public transportation and for all three temporal categories is presented. The figure depicts the averaged OR as a percentage in relationship to the normalized distances to the center, and includes the resulting function as well as the coefficients of determination (i.e. R^2) product of fitting the linear function to the ordered pairs.

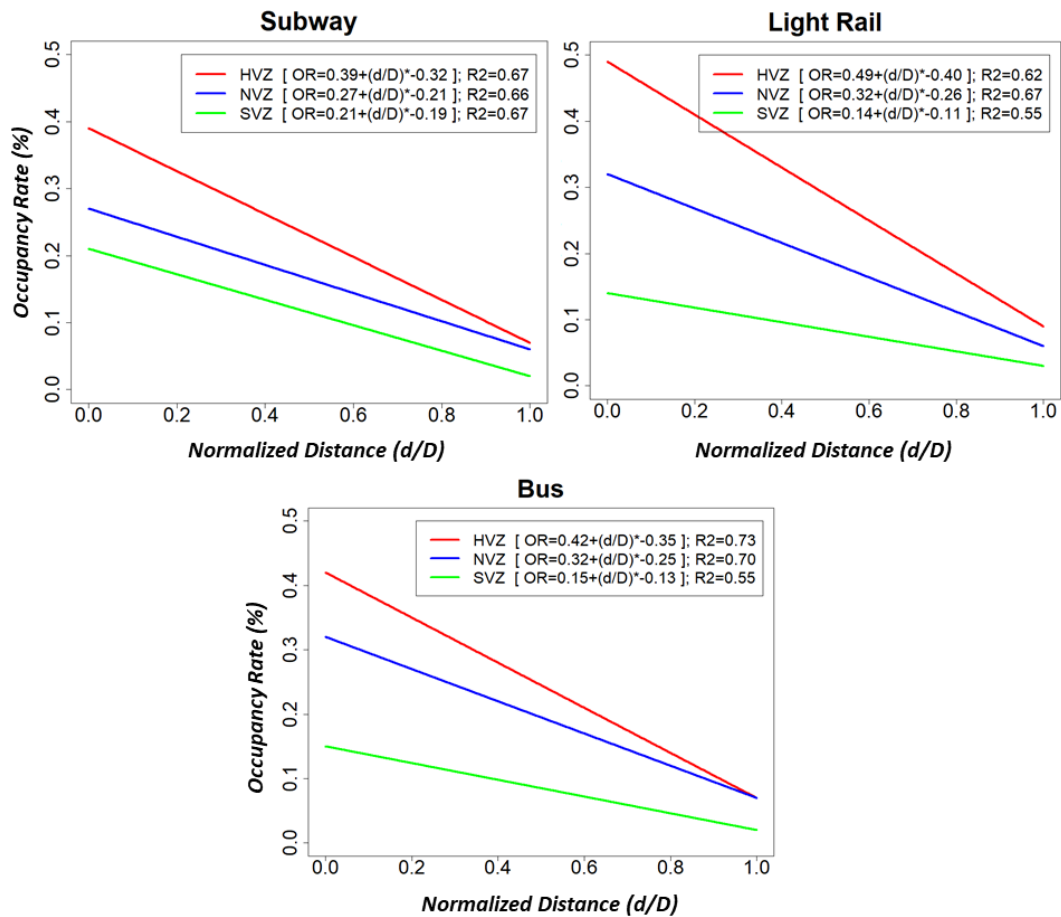

Figure 4.10 Results from the function fitting process: Fitted OR function for all assessed modes across the three temporal categories (by author)

As it can be appreciated in figure 4.10, the regression performed to derive the linear functions delivered coefficients of determination R^2 above the 0.55 range for all means of transport within every considered temporal category. Furthermore, the coefficients of determination are somewhat similar across all assessed public transport modes during the HVZ and NVZ, with values of R^2 between 0.6 and 0.7. However, during the SVZ, the investigated public transport lines, primordialily for bus radial lines, provide a much sporadic service. This situation limited the data availability, thus, deriving lower coefficients of determination of the fitted functions.

4.4.3. Discussion on the Resulting Mode and Time Specific OR Functions

With the results from the regression, the relevance of the five assumptions derived throughout subsection 4.3 can be validated. The validation should be conducted in close consideration of the requirements discussed in subsection 3.4.1.

The five assumptions derived in subsection 4.3.2 explained that the OR function:

1. can be expressed as a function of the time of the day (i.e. temporal category - HVZ, NVZ and SVZ – see subsection 3.6.1),
2. can be expressed as a function of its evaluated location in correspondence to a mobility center of gravity,
3. experience a systematic growth as it approaches the identified mobility center of gravity,

-
4. produce maximum values during the peak hours of normal working days near the mobility center of gravity and
 5. be explained by a monotonically decreasing function vis-à-vis its measured distance from the local mobility center of gravity.

The two initial assumptions anticipated that the OR could be expressed as a function of the temporal category and its measured distance to the mobility center of gravity. The ordered pairs utilized to fit the linear function have been derived, as discussed in subsection 4.3.3. Therefore, every ordered pair for every investigated mode represents the averaged OR per temporal category (i.e. HVZ, NVZ and SVZ) measured at a certain normalized distance from the mobility center of gravity. All the nine functions have been fitted utilizing ordered pairs as the ones described above. Since a correlation has been satisfactorily identified across all nine functions, it is possible to conclude that the first two assumptions are valid.

Assumptions number three and number four anticipated that the OR function would produce a maximum the closest it is measured from the mobility center of gravity and that its slope should be steeper during peak hours. Detailed contrast of the fitted functions displayed in figure 4.10 with the proposed assumptions displayed in figure 4.2 would support the aforementioned assumptions. The OR function's slope across all three public transport modes becomes steeper for every temporal category (i.e. SVZ, NVZ and HVZ), as it approaches the HVZ. Additionally, the maximum across all OR functions are identified at the mobility center of gravity. Consequently, it may be concluded that assumption three and four are also valid.

Finally, assumption number five anticipated that the OR could be explained by a monotonically decreasing function vis-à-vis its measured distance from the local mobility center of gravity. Since an inverse relationship between the OR and its measured distance to the mobility center of gravity has been established for all three means of public transport and temporal categories, the fifth assumption can be successfully validated. While the type of function may be adjusted (e.g. a cumulative frequency curve), the fit provided with a linear function (i.e. coefficients of determination detailed in figure 4.10) is sufficiently compatible with the requirements detailed in subsection 3.4.1. Therefore, by considering the overall objective and limitations of the proposed model and the features of the retrieved data (e.g. sample size - see subsection 4.3.3.) the linear function is suitable enough to conduct the estimation of the OR as foreseen in the objectives of this *Section* (see subsection 3.2.1).

Therefore, with the aid of the fitted OR functions depicted in figure 4.10, it is possible to conclude that all the five assumptions derived in subsection 4.3.2 have been successfully validated.

Furthermore, the results are also compatible with capacity planning and management features. It can be observed that the maximum OR value never exceeds 50%, which is to be expected since the acceptable value conveyed in the German transport quality standards is 65% (VDV 2001). This would indicate that in Germany, a conventional bus or light-rail line would have the equivalent of 50% of its total capacity as residual capacity all along its route, an additional 15% more than specified in (VDV 2001). This last percentage would be even higher for a subway line (i.e. up 25%).

On another note, comparing the studied phenomenon between the evaluated modes illuminates the following observations:

-
- Primarily, subway networks not only have the lowest OR during the HVZ and NVZ as compared to the other two modes, but also, the steepness of their OR slopes is the lowest within these temporal categories.
 - Lastly, when compared solely with the results from the evaluated light rail lines, the differences of recorded qualities between modes are apparent. Light rail networks experience substantial shifts in their OR throughout the whole day, accentuating the importance of the spatiotemporal nature of demand. For example, during the SVZ, they devise the lowest OR when compared to the rest modes.

All in all, the OR functions can be expanded to include other public transport modes (e.g. commuter railway services) relying on the same methodological structure. Moreover, a special inquiry can be made to elucidate the average OR during the 20 min peak period, where the quality standards permit a maximum occupancy of 80%.

4.5. Development of a General Public Transport Residual Capacity Estimation Model

The development of a general public transport residual capacity estimation model would directly address the specific objective of the first *Section* of this work discussed in subsection 3.2.1. As discussed in subsection 3.5.2, the structuring of the model is guided by decomposition and constructive heuristic methods and assembled through a rule-based algorithm. On the one hand, the problem has already been decomposed, resulting in a general approach supporting the estimation of the residual capacity discussed in subsection 4.3. The model should utilize the general approach supporting the estimation of the residual capacity derived in subsection 4.3 as a general framework to arrange its structure. In this regard, the model can make direct use of the assembled OR functions that have been already validated throughout subsection 4.4.

The model supporting the assessment of passenger rerouting strategies based on an estimation of the public transport residual capacity is derived in this subsection. Since the model must be purposefully aligned to support the requirements and limitations derived in subsections 3.3.1 and 3.4.1, the general capabilities that the model must support are first derived in subsection 4.5.1. Later, the overall structure of the model, based on the requirements set forth in subsection 4.5.1, is derived in subsection 4.5.2. Finally, certain model processes are discussed in further detail between subsections 4.5.3 and 4.5.6.

4.5.1. Requirements and Limitations for the Residual Capacity Estimation

Adhering to the limitations (see subsection 3.3.1), requirements (see subsection 3.4.1), and guided by the method discussed in subsection 3.5.2, the capabilities to be supported by the residual capacity estimation model are discussed throughout this subsection.

At the outset, the general model for estimating the public transport residual capacity to be developed in this subsection has the specific aim of assessing and supporting the development of intermodal passenger rerouting strategies by taking into consideration the residual capacity of the local public transport systems being utilized. Therefore, two general capabilities of the model must be supported by its structure. On the one hand, the model must ensure its ability to integrate the passenger rerouting strategies from the DRP operating program under investigation. The strategies within the DRP operating program may be derived from models like the one proposed by Brauner and Oetting (2019) discussed in subsection 2.3.3. On the other hand, the proposed model must ensure it is able to estimate the residual capacity across the utilized public transport modes in

every rerouting strategy within the DRP operating concept under investigation. Consequently, the proposed model should incorporate the residual capacity estimation framework that was derived and validated throughout subsections 4.3 and 4.4 to conduct the estimation of the public transport residual capacity.

The model's overall residual capacity estimation framework can be better appreciated in the example provided by figure 4.11. Two different aspects of the analysis can be recognized: on the one hand, the general approach that focuses on the interplay between the scheduled capacity and public transport demand as described in subsection 4.3 (see figure 4.2), and on the other hand, the deployment circumstances of the model as described by the model's objectives (see subsection 3.2.1).

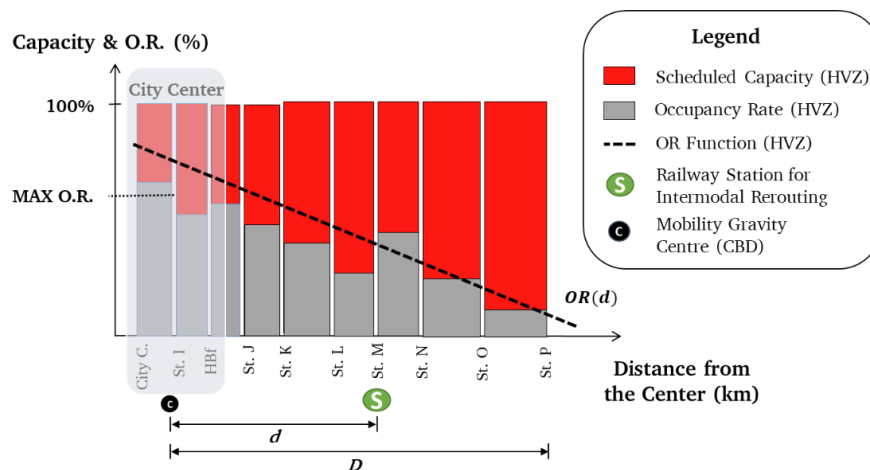

Figure 4.11 Public transport mode specific OR function within a railway disrupted situation (by author)

Similar to figure 4.2, in figure 4.11, the red bars depict the scheduled capacity of a particular line, which in this case, specifies the vehicle's scheduled passenger hauling capabilities. The gray bars represent the actual occupancy of the vehicle, and clearly demonstrate inherent OR fluctuations throughout the route in concordance with the broader operational environment (i.e. city center area, mobility center of gravity, route lengths, etc.).

Furthermore, since the deployment circumstances of the whole approach are subjected to disrupted railway operations, specific disruption related information must be integrated in this structure. Integrating DRP information in this analysis enables an identification of the spatial and temporal limits to conduct the general residual capacity estimation. More specifically, through the information detailed in the DRP transport concept (see subsection 2.4.3), it is possible to identify the precise locations in the public transport network at which the passenger rerouting strategies are to be deployed. Furthermore, the deployment of the rerouting strategies must also consider the specific time of the day at which the residual capacity is to be computed. As evidenced during the OR function assembly process, the most critical capacity limitation situations tend to transpire during the HVZ.

Once the spatiotemporal limits have been established, it is possible to locate the public transport stops, which are particularly relevant for the rerouting of the disrupted passengers. With these stops identified, it is clear which public transport lines require the residual capacity limitation to be assessed. The public transport demand at the specific passenger rerouting points can be estimated by consulting the already validated OR function, specific to the mode of transport and time of day. Additionally, in line with the requirements outlined in subsection 3.3.1, there is still

a need to guarantee the necessary mechanisms to prevent harming the welfare of the original users of the selected lines. Thus, the residual capacity computed by the model ought to consider the OR function at its maximum value, thereby safeguarding to some extent, the welfare of the users of the considered lines.

Now that the overall capabilities have been discussed, the general capabilities of the residual capacity estimation for existing public transport structures can be organized into a model with general validity.

4.5.2. General Residual Capacity Estimation Model

This subsection outlines the framework of a new approach for estimating the residual capacity of existing public transport structures during passenger rerouting strategies. The framework has been advanced based on the capabilities discussed in subsection 4.5.1.

Figure 4.12 describes all the relevant steps that streamline the residual capacity estimation, which are further explained in the forthcoming subsections (4.5.3 to 4.5.6).

In order to abide with the two overall capabilities discussed in subsection 4.5.1, the approach is divided into three segments: firstly, the inputs lay the foundation for the evaluation process, then the public transport lines relevant to the DRP transport concept under investigation are isolated, and finally, taking into consideration the welfare of the original public transport users, the residual capacity can be identified.

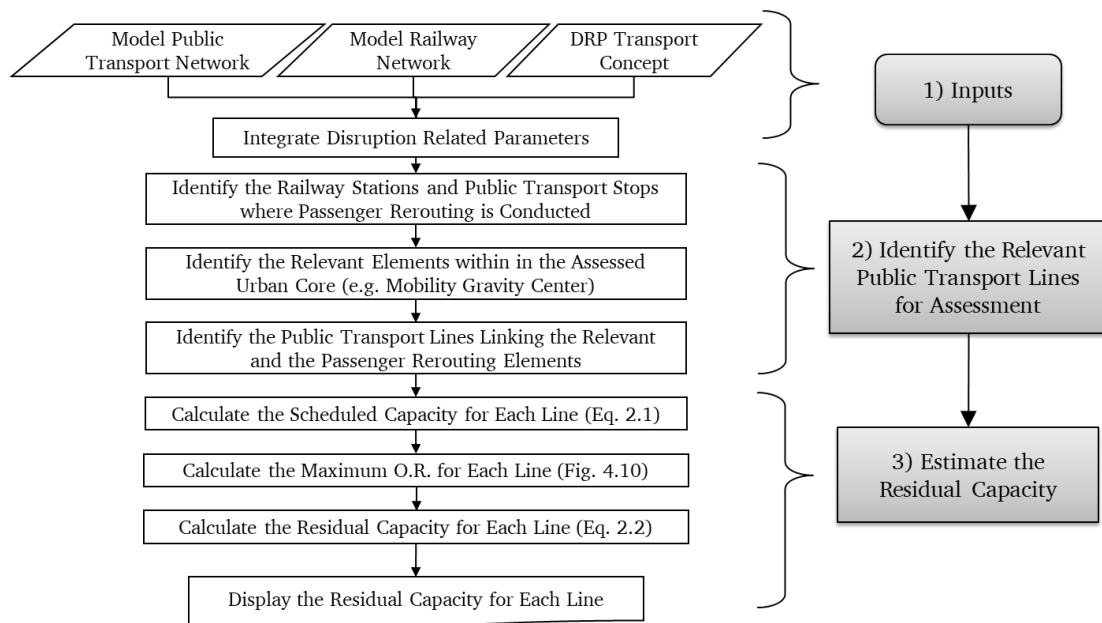

Figure 4.12 Flow chart for estimating the residual capacity (by author)

In the first step, it is necessary to model the lines of the public transport network and the relevant commuter railway network sections. Later, relevant railway disruption related information contained within the DRPs is included. Together, these provide the foundations upon which the assessment is conducted. At this stage, it is possible to identify the most relevant public transport lines by linking specific public transport stops with the railway stations where the passenger rerouting take place or simply recognizing the lines that are foreseen to be utilized for passenger rerouting purposes within the DRP transport concept.

The scheduled and used capacities are then computed for each of the identified lines. In due course, it is finally possible to assert the residual capacity for each of these lines bearing in mind that the maximum occupancy rate must be identified.

The three above-discussed steps constitute the model for estimating the residual capacity of public transport means within the context of passenger intermodal rerouting strategies. Each of the steps detailed in figure 4.12 is further detailed throughout the following subsections. Initially, the modelling of the general public transport and railway networks are detailed in subsection 4.5.3. Later, subsection 4.5.4 describes the process for integrating relevant disruption-related information and for identifying the relevant public transport lines. Finally, subsection 4.5.5 and 4.5.6, describe the processes to compute and aggregate the residual capacity.

4.5.3. Modelling the General Public Transport and Railway Networks

At the outset, the public transport network is modeled by a combination of nodes and links represented through the sets (A, B) where $A = \{a_1, a_2, \dots, a_o, \dots, a_n\}$ represents the set of all stops, and $B = \{b_1, b_2, \dots, b_p, \dots, b_n\}$ represents the sets of all available links between the nodes. The index o makes it possible to differentiate public transport stops within the set A ; where $o \in \{\mathbb{N}_0\}$. Similarly, p stands as the index for distinguishing a specific link between two nodes serviced by at least one public transport mode in the set B ; where $p \in \{\mathbb{N}_0\}$. Consequently, each link b_p represents a direct connection between two specific nodes $(a_o - a_{o+1})$. There can be more than one link bridging two nodes as they represent the routes between one or more public transport lines.

As with public transport, commuter railway networks are also arranged in a combination of nodes and links represented by sets (Y, Z) . The set $Y = \{y_1, y_2, \dots, y_w, \dots, y_n\}$ groups all commuter railway stations and $Z = \{z_1, z_2, \dots, z_x, \dots, z_n\}$ represents the links that connect these stations. Furthermore, the index x is bound to denote a link z_x bridging the nodes $(y_w - y_{w+1})$.

Given its metropolitan nature, the limits of the modelled commuter railway network are bound by the range of the local public transport systems. This limit is imposed since the assessed passenger rerouting strategies can not be conducted if there are no existing links between the commuter railway station and the public transport network. Therefore, it clearly follows that all railway stations laying outside the reach of the public transport system are not relevant to an analysis of the capacity limitations of the local public transports structures.

Figure 4.13 depicts a simplified example of a commuter railway network (Y, Z) , which is bounded to the limits of the public transport network (A, B) .

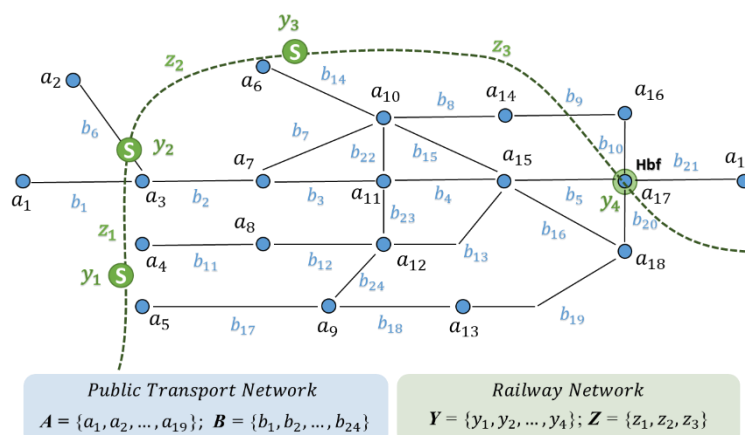

Figure 4.13 Example of the modelling of the railway and public transport networks (by author)

Once the limits have been established for all available public transport modes, the set $L = \{l_{1,dir_1}, l_{1,dir_2}, \dots, l_{n,dir_s}\}$ contains all lines servicing the public transport network (A, B) , including the relevant lines of the commuter rail network. Respectively l_{j,dir_s} where l represents a particular line number for public transport mode j , with a direction of travel s ; where $j \in \{N_0\}$, $s \in \{N_0\}$.

Each line l is generally comprised of two directions of travel, hence: $s = \{1, 2\}$. Moreover, j may acquire the following values: $j = \{1, 2, 3, 4\} \rightarrow (1=Bus; 2=Light rail; 3=Subway; 4=Commuter railway)$, as an example of the modes utilized throughout this OR function validation.

Ultimately, every public transport line and each direction of travel is constituted by a sequence of links $l_{j,dir_s} (b_1, b_2, b_p \dots b_n)$; where $b \in l$. The links are ordered systematically in the direction of travel, thus, allowing the public transport line's route distance to accumulate between the nodes. The first node in the first link represents the initial stop or origin of the line and the last node in the last link represents the final destination stop of the line.

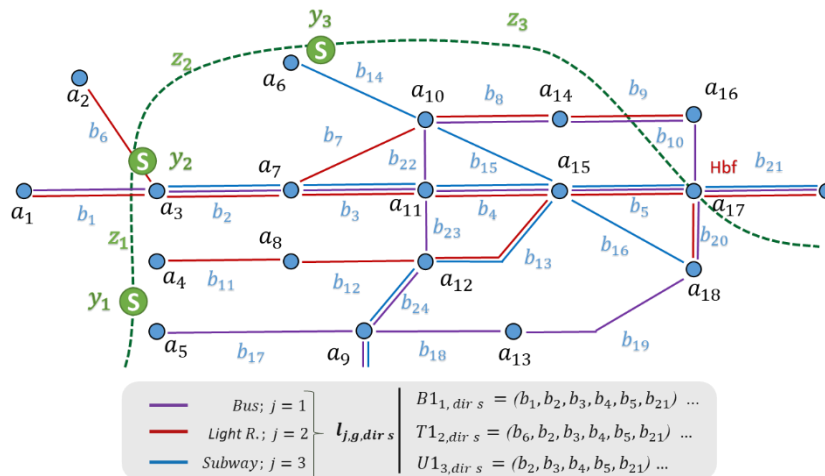

Figure 4.14 Example of the modelling of the railway and public transport lines (by author)

Figure 4.14 is an example of line modelling, where additional details have been added to the network depicted in figure 4.13 to display a broad set of lines for every mode of transport. Here, both the commuter railway network and the general public transport network with mode-specific lines are effectively modelled. This constitutes the groundwork for the subsequent processes in which the residual capacity of specific public transports lines is estimated.

4.5.4. Integrating Relevant Disruption-Related Determining Variables and Identifying the Relevant Public Transport Lines

Including relevant railway disruption-related information in the model allows for the identification of spatial aspects needed to estimate the residual capacity. More specifically, the identification of the relevant nodes, which permits to establish the lines of the public transport network that are either foreseen to be utilized or that can be utilized for intermodal passenger rerouting purposes and that require a residual capacity estimation.

In first instance, the subset $Yd \{y_1, y_2, \dots, y_w \dots y_n\}$ represents the commuter railway stations in which passenger rerouting strategies are foreseen to be conducted; where $Yd \subseteq Y$. These stations are detailed in the DRP transport concept developed for a specific disrupted situation. Therefore, the subset Yd is immediately associated with a DRP transport concept from the set $DRP \{DRP_1, DRP_2, \dots, DRP_n\}$.

By the same token, the subset $Ad \{a_1, a_2, \dots, a_o \dots a_n\}$ represents the public transport stops around the disrupted railway stations selected in subset Yd ; where $Ad \subseteq A$. Therefore, a substantial share of the elements in Ad constitute the origin or objective locations in the public transport network where the passenger rerouting will be conducted, and as such where an estimation of residual capacity will be required. The relationship between a commuter railway station within the subset Yd and a neighbouring public transport stops Ad is represented by:

$$e_{a_o, y_w} = \begin{cases} 1, & \text{if } a_o, y_w \text{ are connected} \\ 0, & \text{if they are not} \end{cases}$$

If the element e_{a_o, y_w} acquires a value of 1, this means there is an effective nexus between the public transport stop a_o with a specific commuter railway station y_w ; where $a_o \in Ad$ and $y_w \in Yd$. In this way, different criteria can be applied to associate a particular public transport station to a commuter railway station.

Before continuing with subsequent steps, the relevance of the local urban qualities must also be recognized, and the point against which all distances are to be referenced must first be established. To this end, the element CBD will represent the mobility center of gravity in the city. This location can be identified by applying the OR validation method, through local knowledge of urban mobility, or ultimately, as detailed in Oetting (2002, p.204) (see subsection 4.3.3).

Figure 4.15 illustrates an example displaying all the elements relevant to a DRP.

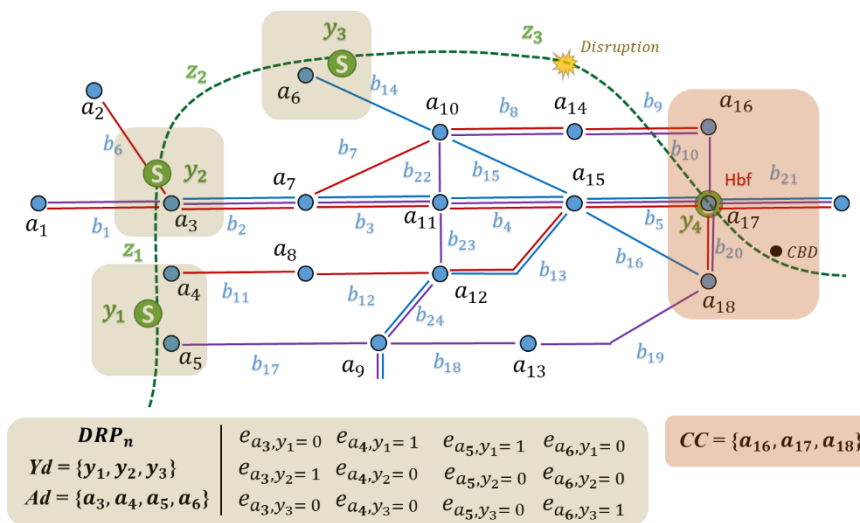

Figure 4.15 Example of the integration of the disruption relevant information (by author)

The subset $CC \{a_1, a_2, \dots, a_o \dots a_n\}$ represents the subset of stops located around the element CBD and across the city center; where $CC \subseteq A$. While the public transport stops within CC may be linked to existing commuter railway stations or not, these stops likely constitute possible objectives and/or generators for rerouted passenger trips. Combined with the subset CC and the element CBD , it is possible to reference the passenger rerouting strategies within the urban area (see figure 4.15).

Subsets Yd and Ad permit to identify potential lines that may require the residual capacity to be estimated. Identifying these public transport lines is critical for the overall effectiveness of the model as it is possible that the DRP transport concept under investigation does not have a detailed outline regarding which public transport lines to utilize for the passenger rerouting.

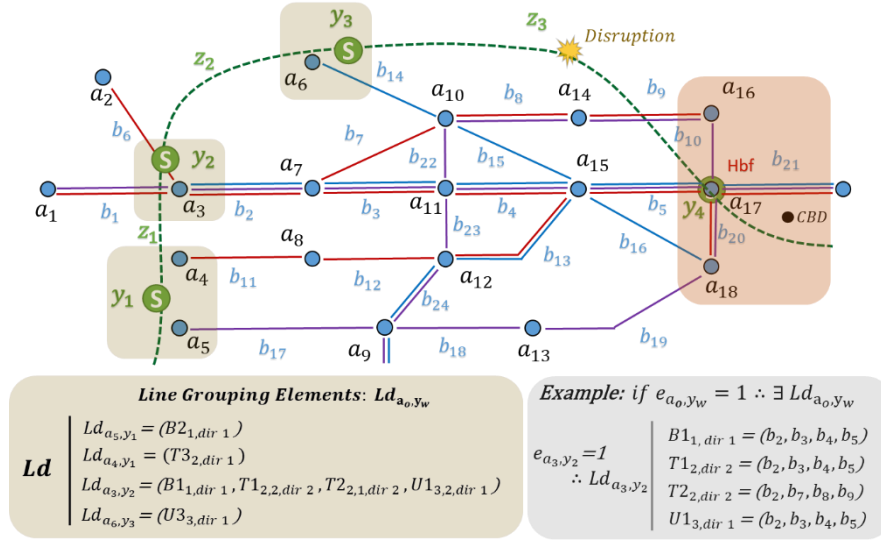

Figure 4.16 Example of the identification of relevant public transport lines (by author)

Figure 4.16 portrays the line identification process as it expands on the example presented from figure 4.13 to figure 4.15. The set Ld_{a_o, y_w} represents a set of public transport lines able to serve as a link between disrupted locations Yd , Ad and the city center CC ; $a_o \in Ad$ and $y_w \in Yd$. The set of sets $Ld \{Ld_{a_1, y_1}, Ld_{a_2, y_2}, \dots, Ld_{a_o, y_w}\}$ contains a set of Ld_{a_o, y_w} elements; where $Ld \subseteq L$. The public transport lines $l_{j, dir s}$ included in the set Ld_{a_o, y_w} only become relevant if the stop a_o is effectively connected to at least one railway station y_w part of the subset Yd , hence, if the element e_{a_o, y_w} is equal to one:

$$e_{a_o, y_w} = \begin{cases} 1, & \exists Ld_{a_o, y_w} \\ 0, & \nexists Ld_{a_o, y_w} \end{cases}$$

The identification of public transport lines following the above-discussed approach would allow establishing public transport lines that may be relevant for intermodal passenger rerouting purposes as they link the city center with the commuter railway stations in which passenger rerouting strategies are foreseen to be conducted (according to the DPR transport being investigated).

However, there are two alternatives approaches that can be established to include a line $l_{j, dir s}$ in a subset $Ld_{a_o, y_w} \{l_{1, dir 1}, l_{1, dir 2}, \dots, l_{j, dir s}\}$.

First, following the above-discussed approach, a public transport line $l_{j, dir s}$ is included in a set $Ld_{a_o, y_w} \{l_{1, dir 1}, l_{1, dir 2}, \dots, l_{j, dir s}\}$ if one of its links b_p includes an element a_o clustered in the subset Ad as one of its nodes, and down its link sequence another link b_n contains a node belonging to subset CC or Yd as a destination.

Second, abiding by the DRP transport concept under investigation, a public transport line $l_{j, dir s}$ is included in a set $Ld_{a_o, y_w} \{l_{1, dir 1}, l_{1, dir 2}, \dots, l_{j, dir s}\}$ if the line $l_{j, dir s}$ is foreseen to be utilized as a part of a rerouting strategy in the investigated DRP. This alternative requires to ascertain the stop a_o where the rerouting strategy is set to take place and stop a_n that constitutes the objective of the intermodal rerouting strategy. It must be considered that at least the origin stop a_o must be effectively connected to at least one railway station y_w part of the subset Yd , hence, if the element e_{a_o, y_w} is equal to one.

In case any of the identified lines have more than one link with further nodes that are part of subset CC , the node closest to the element CBD is the only one considered in the assessment. However, if there is a public transport line that services more than one element, which is part of the subset Ad , the line's residual capacity is estimated, as foreseen in the DPR transport concept under investigation.

Now that both the commuter railway and public transport networks have been modelled for their analysis, and the relevant disruption-related information has been incorporated, it is possible to conduct the residual capacity estimation on each of the identified lines $l_{j,dir s}$.

4.5.5. Calculating the Residual Capacity

Once the relevant public transport stops around the commuter railway stations detailed within the DRP transport concept are identified, it is possible to proceed towards assessing the residual capacity of the corresponding lines. Adhering to the framework described in subsection 4.3, particularly with regards to equations 2.16 and 2.17, it is essential to build the capacity-related features into the model.

First, it is indispensable to assert the scheduled capacity for each one of the identified lines by means of equation 2.16. In this regard, $V_{C_{i,l_{j,dir s}}}$ embodies the vehicle-specific capacity (including sitting and standing places) at a certain time of the day i for line $l_{j,dir s}$; where $V_{C_{i,l_{j,dir s}}} \in \{\mathbb{N}_0\}$. The index i indicates the time of the day for which the assessments is being conducted. Abiding by the general framework, the time of day is circumscribed in one of the three temporal categories (i.e. HVZ, NVZ and SVZ – see subsection 3.6.1); where $i = \{1, 2, 3\}$, being (1 = HVZ; 2 = NVZ; 3 = SVZ).

Correspondingly, the variable $f_{i,l_{j,dir s}}$ signifies the frequency at a certain time of day i for a line $l_{j,dir s}$; where $f_{i,l_{j,dir s}} \in \{\mathbb{N}_0\}$. Lastly, the defined time period t_{def} , is taken as one hour (60min) to provide the residual capacity information in passengers per hour. Together, these determining variables allow ascertaining the scheduled capacity $C_{i,l_{j,dir s}}$ of a specific public transport line $l_{j,dir s}$ at a certain time of day i , as generalized in equation 4.3.

$$C_{i,l_{j,dir s}} = \frac{V_{C_{i,l_{j,dir s}}}}{f_{i,l_{j,dir s}}} * t_{def} \quad (4.3)$$

Once the scheduled capacity has been asserted, the objective variable can be calculated. Equation 2.17 is generalized in equation 4.4 for its use within the model. $RC_{i,l_{j,dir s},d}$ describes the residual capacity at a certain time of day i , for a particular public transport line $l_{j,dir s}$ at a normalized route distance $d_{l_{j,dir s}}$ from the element CBD .

$$RC_{i,l_{j,dir s},d} = C_{i,l_{j,dir s}} * \left[1 - OR_{j,i} \left(d_{l_{j,dir s}} \right) \right] \quad (4.4)$$

As established in subsection 4.3 and validated in subsection 4.4, the $OR_{j,i} \left(d_{l_{j,dir s}} \right)$ can be expressed as being in function of the mode j , time of day i and the line's normalized route distance $d_{l_{j,dir s}}$ to the mobility center of gravity. In order to estimate the OR for line $l_{j,dir s}$, the functions displayed in figure 4.10 can be implemented as a product of the validation process detailed in subsection 4.4.

To implement the functions displayed in figure 4.10, it still is necessary to establish the normalized route distance d_{l_j,dir_s} at which the OR must be estimated.

The line's normalized route distance d_{l_j,dir_s} stems from dividing the evaluating route length by the line's total route length (both measured in relation to the element CBD). It should be noted that determining both route lengths follows a similar process as the one explained in subsection 4.3.3.

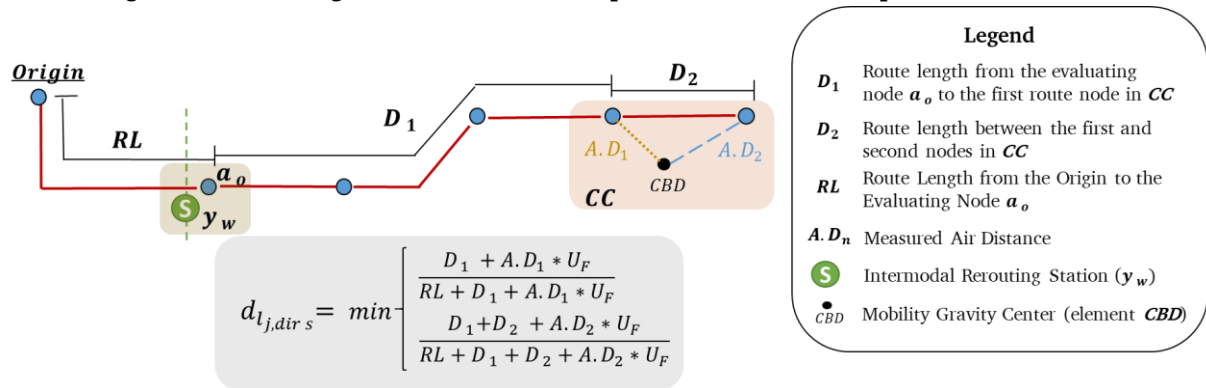

Figure 4.17 Example of the establishment of the evaluating route length and the total route length vis-à-vis the mobility center of gravity (by author)

The total route length is the accumulated distance across all the links, between the line's origin stop a_{origin} to the stop located the closest to the element CBD plus the air distance between the stop and the element CBD multiplied by the detour factor U_F (see figure 4.17). The detour factor U_F is calculated as in equation 4.2. To establish which of the stops is located the closest to the element CBD , the total route length must be assessed for every alternative stop located the closest to the element CBD . Finally, the stop that delivers the minimal total route length, as depicted in figure 4.17, is the one utilized as the total route length.

Furthermore, to establish the evaluating route length, the two elements, which are central for evaluating the passenger intermodal rerouting strategy, must be recognized. On the one hand, the stop a_o where the rerouting strategy is set to take place, and on the other hand, the stop a_n objective of the rerouting strategy. Thus, there two evaluating route lengths that can be established:

1. The first evaluating route length is computed between the stop a_o where the passenger rerouting strategy takes place and the stop located the closest to the identified mobility center of gravity.
2. The second evaluating route length is computed between the stop a_n objective of the passenger rerouting strategy and the stop located the closest to the identified mobility center of gravity.

Additionally, it must be considered that the public transport stops located in the subset CC (i.e. around the CBD) may also constitute potential objectives of the passenger rerouting strategies (see subsection 4.5.4).

Figure 4.17 presents an example, which is inspired by the assessment of operational information (see subsection 4.4) and is instrumental for understanding the process of identifying the normalized route distance d_{l_j,dir_s} . Figure 4.17 constitutes an example where the objective of the passenger rerouting strategy is an element in the subset CC . In addition, the figure also depicts the difference between the evaluating route length and the line's total route length, as well as the identification of the stops laying the closest to the element CBD .

From the approaches described above, there are two normalized route distance d_{l_j,dir_s} that can be established for every investigated line and where the OR should be assessed. As discussed in subsection 3.4.1, the evaluated passenger rerouting strategies should not hinder the normal operation of the appraised public transport lines. Therefore, the OR must be calculated for the route distance d_{l_j,dir_s} that delivers the maximum OR, as generalized in equation 4.5.

$$\max OR_{j,i}(d_{l_j,dir_s}); d_{l_j,dir_s} \quad (4.5)$$

Once the maximum OR for each relevant line has been identified, the line-specific residual capacity can ultimately be computed.

4.5.6. Aggregating Residual Capacity for each Rerouting Railway Station

For the overall comparison of the passenger rerouting potentials throughout the chosen commuter railway stations, the residual capacity of all lines within the subsets Ld can be aggregated.

Firstly, the residual capacity for all the public transport lines in Ld_{a_o,y_w} , is accumulated. Consequently, the aggregate residual capacity per mode j , at the public transport stop a_o connected to the rerouting railway station y_w at a certain time of the day i is computed as in equation 4.6.

$$RC_{a_o,y_w,j,i} = \sum_{l \in Ld_{a_o,y_w}, l=1}^n RC_{i,l_j,dir_s,d} \quad (4.6)$$

In the same way, the residual capacity per mode j , at a time of the day i , available at each railway station y_w can be computed as in equation 4.7.

$$RC_{y_w,j,i} = \sum_{o=1}^n RC_{a_o,y_w,j,i} \quad (4.7)$$

Ultimately, the net residual capacity at the station y_w for all the modes available at the surrounding public transport stops at a certain time of the day, stands as generalized equation 4.8.

$$TotRC_{y_w,i} = \sum_{j=1}^3 RC_{y_w,j,i} \quad (4.8)$$

As a whole, the element $TotRC_{y_w,i}$ reveals the general passenger rerouting potential for the affected stations across the disrupted area at a certain time of the day.

4.6. Implementation and Example

To put the implementation potentials of the proposed model in perspective and to exemplify the deployment of the OR function, a disrupted scenario affecting the commuter railway network of the city of Stuttgart, Germany, is evaluated. The evaluation follows the steps proposed in the flowchart displayed in figure 4.12 with the objective of calculating the residual capacity of the public transport modes that match the simulated DRP.

4.6.1. Implementation – Situation

The simulated disruption in figure 4.18 transpires between the S-Bahn stations “Bad Cannstatt” and “Hauptbahnhof (Tief)” fully disrupting the S-Bahn traffic towards and from Stuttgart’s central station during the HVZ. As part of the DRP transport concept DRP_1 , two potential rerouting strategies will be evaluated.

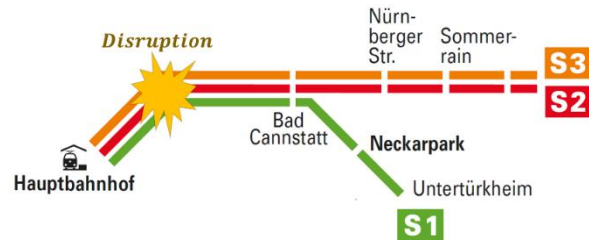

Figure 4.18 Stuttgart’s S-Bahn Lines S1, S2 and S3 around the Disrupted Area (VVS 2017; modified by author)

Figure 4.19, depicts the modelling of both the railway and the public transport networks within the framework of the DRP transport concept DRP_1 . The modelling includes the assessed rerouting locations (i.e. part of the subsets Yd, Ad, CC) and the already identified public transport lines (i.e. Ld_{a_o, y_w}).

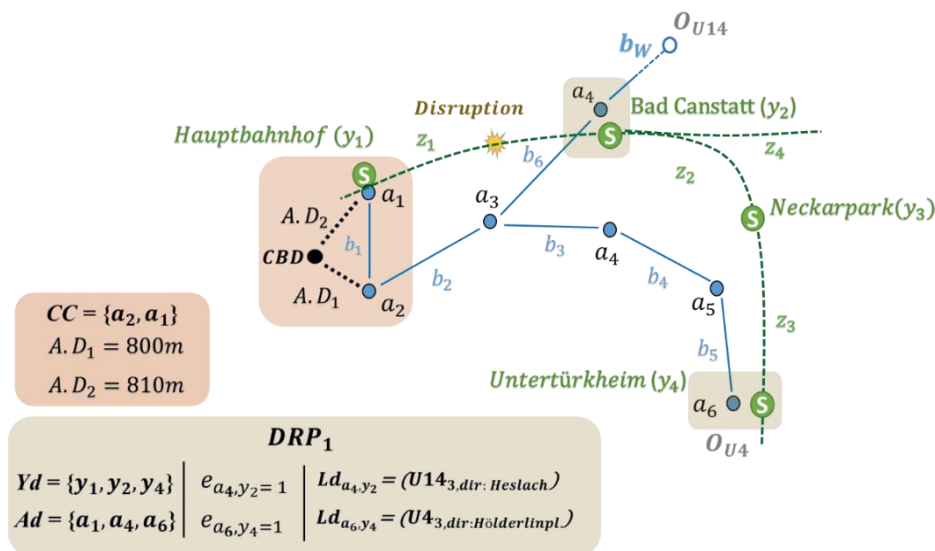

Figure 4.19 Example of the implementation of the proposed modelling framework in a disrupted scenario (by author)

DRP_1 envisions the rerouting of passengers travelling on line S1 in the direction of Stuttgart’s central station (Hauptbahnhof), at station “Untertürkheim” (i.e. Y_4) to the light rail line U4. Furthermore, it anticipates the rerouting of passengers on lines S2 and S3 also in direction to Stuttgart’s central station at the station “Bad Canstatt” (i.e. Y_2) to the light rail line U14. The objective of both passenger rerouting strategies foreseen to be the element CBD (see figure 4.19). Furthermore, it is worth pointing out that the simulated passenger rerouting strategies are focused exclusively on exploiting the effectiveness of the existing light rail system; thus, other transport means are left aside during this evaluation.

As an intrinsic part of the residual capacity estimation model, the implementation-specific determining variables like the vehicle hauling capabilities, line frequencies and the city-specific qualities (e.g. mobility center of gravity, stops within the core) must be identified for each of the networks being assessed. The city-specific elements like the route lengths, their relevance within

the public transport networks, and their normalizations should be identified utilizing steps i) and iii) detailed in subsection 4.3.3. Features of the scheduled capacities may be derived from the local operators, particularly the utilized vehicle capacities, as these values fluctuate substantially between different operational environments. However, general values from table 2.15 detailed in subsection 2.4.4 can also be utilized, as discussed in subsection 4.3.1.

Since the rerouting strategies being evaluated as part of this example have already been studied throughout the OR function assembly and validation, most of the information has already been identified. For example, the mobility center of gravity, the public transport stop located the closest to this element, the route length between stops, etc. (see figure 4.8 and table 4.9).

4.6.2. Residual Capacity Estimation Results

The scheduled capacities, the OR and its maximum values are calculated for each one of the identified lines as detailed in table 4.14. Finally, the residual capacities for both lines are estimated.

Table 4.14 Example of the estimation of the residual capacity for Stuttgart’s light rail lines U4 and U14 during the HVZ (by author)

<i>Assessed Station (Ad)</i>	<i>Untertürkheim (a_6)</i>	<i>Bad Canstatt (a_4)</i>	<i>Source or Calculation</i>
<i>Lines</i>	<i>U4</i>	<i>U14</i>	<i>DRP</i>
<i>Nodes in CC</i>	$\{a_1, a_2\}$	$\{a_1, a_2\}$	Figure 4.19
<i>1st Node in CC</i>	a_2	a_2	Figure 4.4
<i>Modelled Links</i>	$\{b_1, b_2, b_3, b_4, b_5\}$	$\{b_1, b_2, b_6, b_W\}$	Figure 4.19
<i>Closest Node to CBD</i>	a_2	a_2	<i>DRP ($A.D_1 < A.D_2$) Table 4.10</i>
<i>Distance from CBD to Closest Node Inc. $U_F(d)$ [m]</i>	904	904	Table 4.10
<i>Evaluating Distance (Ad - CBD) (d) [m]</i>	6585	5340	Measured
<i>Total Line Length ($O_{line} - CBD$) (D) [m]</i>	6585	16120	Measured
<i>Norm. Evaluating Distance to Yd</i>	1	0.33	d/D
<i>Norm. Evaluating Distance to 1st CC</i>	0.13	0.06	d/D
<i>Frequency [min]</i>	10	10	Timetable
<i>Avg. Vehicle Capacity [Passengers]</i>	246	246	VVS 2016d
<i>Scheduled Capacity [Pass/hr]</i>	1476	1476	Eqq. 4.3
<i>Occupancy at Yd during HVZ [%]</i>	9	36	Figure 4.10
<i>Max Occupancy at CC [%]</i>	44	47	Eqq. 4.5
<i>Residual Capacity at Ad (Pass/hr)</i>	826	782	Eqq. 4.4

The results displayed in table 4.14 present a perfect summary of each one of the relevant steps described throughout the public transport residual capacity model. Overall, the results allow appreciating the relevance of the model and its ability to conduct a swift exploration of the capacity limitation of existing public transport structures within a straightforward structure.

Furthermore, the results immediately reflect the proficiency of the DRP assessed passenger rerouting strategies. This example plainly displays how relying merely on the light rail system as a means of rerouting passengers to reach the center or vice-versa would not provide enough transport capacity at either of the rerouting locations, even if a low average disrupted passenger count per hour were considered for each S-Bahn line (i.e. 1500 pass/hour/direction). What is more, since the passengers from lines S2 and S3 are projected to be rerouted in the station “Bad

Canstatt”, this makes this node particularly vulnerable as the light rail line U14 would only be able to absorb around 782 passengers per hour per direction.

4.7. Conclusions and Discussion of the Model

As discussed throughout section 3.2.1, a model that allows decision-makers to support the development of passenger intermodal rerouting strategies by taking into consideration the residual capacity of local public transport systems needed to be designed as established by the specific objectives of the first *Section* of this work. The proposed model should provide a framework to assess and support the development of the intermodal rerouting strategies between commuter railway networks and local public transport means derived from exiting DRP transport concepts.

The proposed model enables an assessment of residual capacity across a broad range of public transport structures and diverse operating environments. Its ability to simultaneously determine the assessment locations and isolate particular assets through its railway-disruption module facilitates the stock-taking of intermodal transport replacement strategies potentials and the identification of existing bottlenecks.

The proposed model has been advanced within the framework of DRP development, more precisely, filling the remaining void within the development of DRP transport concepts. Overall, the model allows assessing intermodal rerouting strategies, ultimately enhancing the quality of the resulting DRP transport concepts. Aligned with the enhancement of P&P strategies discussed in subsection 1.4, the resulting model provides an adept example of the way in which the operational continuity of different critical infrastructures can be pre-emptively addressed.

The ability of the model to identify critical locations within such a comprehensive structure, as appreciated in the final example, makes it a proficient evaluating tool with the potential to be included within existing DRP developmental frameworks. Once the capacity limitation issues are identified in specific locations, the rerouting measures to existing public transport structures foreseen in the DRP transport concept can be negotiated with the local public transport operators. In the same way, local public transport companies can also make use of the model to identify further capacity-vulnerable locations within their own networks, where a much more detailed assessment would be needed. Therefore, it is possible to conclude that the specific objective detailed for the first *Section* of this work has been achieved.

The development and assessment of the DRP passenger rerouting strategies remain highly context-specific. The OR function, however, enables bypassing the intricacy behind the arguably most complex context-specific variable to be assessed. Since the OR does not need to be locally readjusted, the already validated OR functions provide a fairly accurate overview to evaluate multiple rerouting scenarios (e.g. times of the day, the structure of the network) within public transport operations. Nevertheless, it is worth noting that referencing the center of gravity is highly susceptible to spatial changes, and thus, the effects of smaller nearby centers on the occupancy must be considered when the proposed approach is being implemented and also for the development of the passenger rerouting strategies.

The resilience of a public transport network is not only advanced through system qualities (e.g. enhanced robustness or redundancy), but adequate mechanisms are also necessary to promptly access key information. It is mainly due to the OR functions that the proposed model is able to swiftly identify critical nodes (e.g. bottlenecks). Thus after a rapid capacity limitation assessment,

in close cooperation with local transport operators and with the adjustment of envisioned strategies, decision-makers are able to envision measures that uphold the welfare of both the original and disrupted users. All these qualities indicate the successful development of a model within the margins of this *Section's* identified objectives, requirements, and limitations.

From this section, it can be concluded that the proposed model offers a solution to close the existing gap discussed in subsection 3.1, namely the lack of a framework, as it allows for the prompt estimation of public transport residual capacity. It provides decision-makers with a relevant platform to contemplate capacity restrictions during the development of rerouting strategies in a wide range of circumstances. In the long run, when the assessment reveals the lack of a substantial residual capacity, it allows pointing out the specific aspects that need to be modified in the assessed rerouting strategies or consider further transport replacement strategies, such as those described in subsection 2.4.3.

5. System Inputs

This section outlines the information required for the proficient development and implementation of the dynamic DRP deployment system. Within this first module, the input information is collected, processed and classified for its implementation in subsequent modules. The required information has already been established in concordance with the dynamic DRP deployment system's requirements and general approach (see subsections 3.4.2 and 3.5.2).

At the outset, it should be noted that the main role of the dynamic DRP deployment system is to serve as a semiautomatic decision-support mechanism supporting the real-time deployment of a chosen DRP operating concept on the actual operating situation of a disrupted commuter railway network. The necessary information is, in essence, the same data that is routinely collected for traffic management purposes during regular operations (i.e. for the monitoring and control of the railway network) (as discussed in subsection 2.2). Since the information that can be acquired from existing traffic management systems may vary in extent or detail, the overall structure can be divided into two groups. The first group of data arrangements is relatively constant and lays the groundwork for the monitoring of the operations. The second group is dynamic in that it establishes the very nature of the objects being monitored. Consequently, considering both groups, the input information in this module is divided into what will hereafter be referred to as "static" and "dynamic" information clusters.

The static cluster contains all information critical for the monitoring of the operations, which does not experience drastic variations between different disrupted events. The three key elements within this group entail the infrastructural information, the original schedules and the circulation plans, from which the operating situation of the investigated railway network can be fully represented. Additionally, since the dynamic DRP deployment system is explicitly aligned with the planned disruption-management (see subsection 2.3.3), all available DRP operating concepts for the commuter railway network under investigation should be made available.

The information of the dynamic cluster is derived from the actual monitoring of the operating situation of the network. It is important to highlight the need for this information to fulfill the objectives of the dynamic DRP deployment system and abiding by the overall approach (see subsection 3.2.2 and 3.5.3). While conventional real-time monitoring focuses on dynamic management of the assets circulating in the network in concordance with the scheduled operations, the proposed system focuses on the dynamic deployment of the chosen DRP operating concept. Thus, the dynamic group entails an acquisition of information that reflects the actual state of the network and across its infrastructural operating components (i.e. vehicles and infrastructural elements – see subsection 3.6.2), once the disruption has taken place.

The following subsections describe in detail the structure, handling and integration of the data arrangements throughout all the inputs introduced in the dynamic DRP deployment system, as discussed in the overall approach (see subsection 3.5.2). Initially, the three input elements within the static group (i.e. infrastructural information, original schedules, circulation plans and disruption programs) are discussed in subsection 5.1 and 5.2. Later, the disruption information as the dynamic or context-specific data arrangement is detailed throughout subsection 5.3 and subsection 5.4. These accounts set the basis for the later processing of the input information throughout the respective modules.

5.1. Infrastructural Information

The infrastructural information as input is essentially constituted by the infrastructure modelling of the commuter railway network.

The evaluating potentials of the existing infrastructural modelling techniques were reviewed in subsection 2.2.2. As discussed throughout subsection 2.3, every approach dealing with the disrupted operations, regardless of reliance on heuristic or exact methods, places great emphasis on the utilized infrastructure modelling technique.

In subsection 2.2.2, both microscopic and macroscopic models have been discussed, as were the limitations regarding their applicability. Microscopic models are very precise and provide a detailed representation of the infrastructure and its operational qualities (e.g. speed profiles). In this way, they constitute a robust source of information, which is well suited for conducting a very detailed adjustment of the schedule. Macroscopic models, on the other hand, make use of a simplified representation of the infrastructure, binding and clustering elements and their characteristics together. This results in solutions with much less detail than in microscopic models, yet the more simplified arrangement makes them very efficient tools for analyzing entire networks.

Comparing the qualities of the infrastructure models against the requirements and overall approach of the dynamic DRP deployment system discussed in subsections 3.4.2 and 3.5.2 allows recognizing which modelling technique is better suited to the purposes of the proposed system.

The system must be able to efficiently address the disruption-management problems across an entire network. However, as a decision-support tool to be implemented during actual operations, the quality of the desired solutions is exchanged to secure efficient processing times. In this regard, the degree of detail and extent of information handled in microscopic models stands in the way of the development of an efficient and network-wide disruption-management. Nevertheless, the use of a simplified macroscopic modelling would prove to be just as problematic, since it may curtail the allocation of dispatching measures or restrict the use of particular elements that would otherwise be accessible to the trains. As a result, the application of mesoscopic infrastructure modelling techniques, as described in subsection 2.2.2, would prove to be particularly appropriate to fulfill the requirements of the dynamic DRP deployment system (see subsection 3.4.2).

5.1.1. Infrastructure Modelling

At its core, enhanced macroscopic infrastructure modelling divides the network into the three basic elements aligned with the archetypal node-link arrangement. Namely, these elements include the tracks represented by links, and both switching zones as well as platform track groups represented by nodes (see figure 5.1 and subsection 2.2.2).

As described in subsection 2.2.2, certain attributes complement the modelling of these three elements. These attributes may range from the incorporation of model trains (see subsection 2.2.1 and 3.6.2) to minimum headway times and respective journey times, serving as the building blocks used to represent an entire network with both simplicity and relative precision. Each of these attributes has been discussed in detail along subsection 2.2.

Aligned with the above-made considerations, the enhanced macroscopic infrastructure modelling introduced by Oetting and Griese (2016a, 2016b), which has been discussed in detail within subsection 2.2.2, acquires particular relevance. The authors introduce a framework merging the baseline capabilities of a mesoscopic infrastructure modelling with a series of algorithms based on

the incorporation of model trains that allow providing the represented infrastructural elements with definite attributes (e.g. minimum headway times, journey times, etc.). The attributes are instrumental for the monitoring of real-time operations.

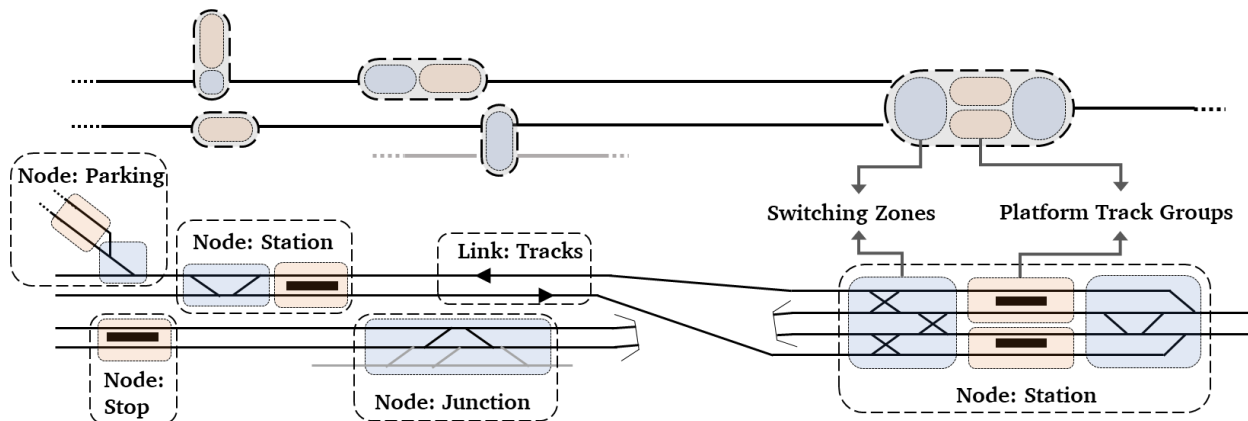

Figure 5.1 Enhanced macroscopic infrastructural node-link model (by author)

Notwithstanding, since the model has not been developed to directly address disruption-management purposes (see subsection 2.2.2), its framework must be first aligned with the dynamic DRP deployment system. The main obstacle faced by the infrastructure modelling technique introduced by Oetting and Griesse (2016a, 2016b), as encountered in existing disruption-management models (see subsection 2.3), is its ability to support dealing with the three main disruption-management problems: schedule adjustment, rolling stock rescheduling and crew rescheduling (see subsection 2.3).

Initially, the ability of the enhanced macroscopic infrastructure modelling framework to handle train schedule adjustment matters (e.g. train rerouting) should be considered. The attributes of the infrastructure model already provide the necessary information to support the schedule adjustment, namely, the spatiotemporal modification of train services (e.g. changes in routes, arrival and departure times from the different nodes). Here, the matrix of reachability (Matrix E), as well as the matrix of conflicts (Matrix K), attributed to the switching zones, and the means to handle the journey, as well as minimum headway times (i.e. Matrix Z – matrix of occupations, see subsection 2.2.2), are key components of the modelling technique supporting the schedule adjustment process (subsection 2.2.2).

Particular attention must be paid to the modelling of the switching zones through relations (i.e. Matrix E), which allows the accessibility between respective tracks, platform tracks and even other switching zones to be represented, as depicted in figure 5.2.

Figure 5.2 provides further detail regarding the modelling of the last station on the right side of figure 5.1. Relying on the relations attributed to switching areas, the malfunction of single switches can be represented by simply removing the respective relations from the matrix. For example, if a switch is disrupted and locked in one position, this can be modelled through the matrix of reachability by temporarily removing the respective relations. By overlying figures 5.1 and 5.2 if all switches that support the construction of the route between track 1 and platform track 102 are locked in position, the matrix in the example can have the following relations removed (i.e. equal to 0): Track1 – PT-101 and Track1– PT-103 (see figure 5.2).

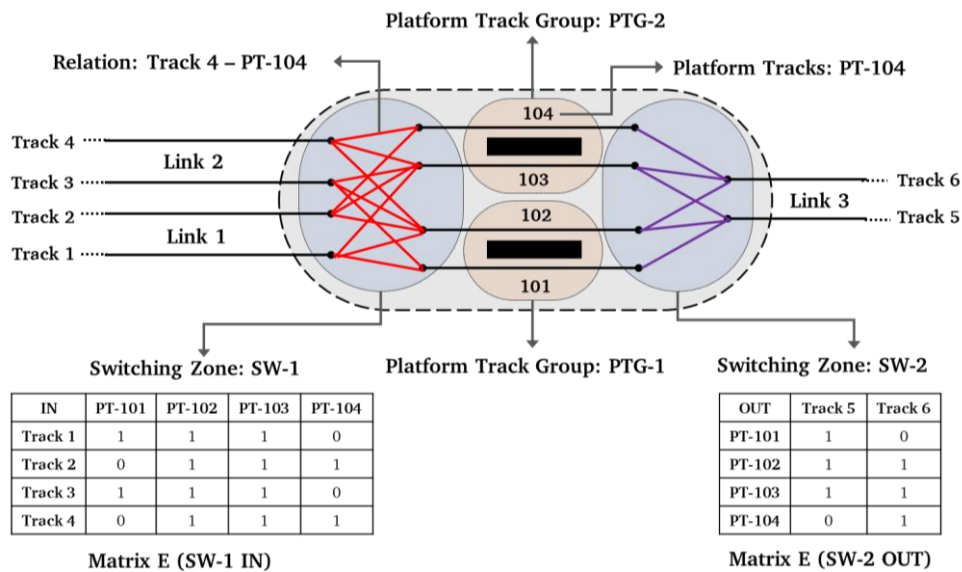

Figure 5.2 Node elements: example of a matrix of reachability (Matrix E) for in and outflows of trains (by author)

Considering the arrangement and the attributes that are allocated to the infrastructural elements, the enhanced macroscopic infrastructure modelling would allow to support the rerouting and the shifting in time of the trains in time throughout the different infrastructural elements during disruptions. Therefore, the modelling technique is aligned with the adjustment of the schedule, as required by the dynamic DRP deployment system (see subsection 3.4.2).

Furthermore, it is difficult to make a direct link between the crew rescheduling matters, discussed in subsection 2.3, and the infrastructure modelling technique. This limitation also extends to rolling stock rescheduling efforts. Both crew and rolling stock management require assigning the starting and ending locations of their assets (i.e. trains) to respectively locate the beginning and end of their operations. Whereas for the rolling stock, these locations are most certainly shunting tracks or deposit, for crew rescheduling, they may also be assigned at stations. Moreover, during disrupted situations, the ability to park a train is widely used as an alternative to matching the capacity of the disrupted network with the overall amount of traffic circulating in the network (see subsection 2.3). Therefore, the ability to locate and utilize parking location is of relevance for advancing the dynamic DRP deployment system.

All in all, the incorporation of model trains, the modeling of switching zones as relations between track and platform track elements, and the availability of algorithms that allow to establish definite attributes for the modelled elements (e.g. minimum headway times - see subsection 2.2.2) make the enhanced macroscopic modelling technique introduced by Oetting and Griese (2016a, 2016b) able to support the adjustment of schedule.

Ultimately, as the modelling of parking locations located across the infrastructure is not included in the scope of the framework introduced by Oetting and Griese (2016a, 2016b), the modelling of parking elements must be introduced. By including a representation of the parking locations in the infrastructure model, the rest of the disruption-management problems detailed in the system's requirements may be addressed (see subsection 3.4.2).

Modelling of Parking Locations

Parking locations are by the definition node elements (see subsection 3.6.2), however, their functional and operational qualities are different from standard network elements (see subsection

2.2). These elements become relevant as they allow dispatchers to match the capacity of the disrupted network with the targeted DRP operating concept by removing some trains out of circulation (see subsection 2.3.3). In contrast, in some situations, parking locations are also the source of potential vehicles and or vehicle compositions that can be introduced in the network (see subsection 2.3.3).

Initially, vehicle parking locations are distributed around the network and do not necessarily belong to any given line. However, their geographical location makes some parking locations particularly relevant to a particular line or set of lines, since they are located in the vicinity of central nodes of the network (e.g. main stations) or near nodes where vehicles finalize their duties.

Furthermore, aligned with the disposition measures discussed in subsection 3.6.2, the representation of parking locations should focus on its ability to support the management of vehicles during a disruption. The ability to support in the management of vehicles during a disruption entails representing parking locations such that the number of parking locations that are available across the network and the number of vehicles in these locations that can be introduced in the network, can be ascertained.

Additionally, it is also worth noting from existing practice that passengers can alight from trains at certain parking locations, meaning that these elements can serve as a terminal for their trips. This information becomes relevant for the scheduling of additional shunting movements (see subsection 3.5.2). Therefore, the representation of parking locations should also be able to convey information regarding their ability to host passengers.

In the modelling framework introduced by Oetting and Griese (2016a, 2016b), a node is constituted by fourteen attributes distributed across platform track groups and switching zones (see subsection 2.2.2). Out of the three node types, only stations have both platform track groups and switching zones, whereas stopping points and junctions can claim only one of these elements. Therefore, the characteristics of parking locations make them similar to whole stations. The necessary additions to each one of the element's attributes are listed below, aligned with previously discussed disruption-management requirements.

Adding to the existing modelling framework from Oetting and Griese (2016a, 2016b), the dynamic DRP deployment system introduces parking locations as part of the three regular node types (i.e. stations, junctions and stopping points). Since they constitute a new node type, the attributes of the parking locations must be aligned with those of already existing nodes. The general attributes included in node elements have been discussed in subsection 2.2.2. As starting and ending locations of train operations, these elements must display their vehicle and passenger management capabilities.

The following attributes should be added to nodes assigned as parking locations:

- *Type of parking available:* as a depo, siding or shunting track
- *List of parking tracks:* the list of platform track groups is exchanged for parking tracks
- *The number of vehicle compositions that can be parked at the node:* this information can be derived either by means of the distance properties of the parking tracks (i.e. platform tracks in the normal model) vis-à-vis the vehicle lengths specified for every model train and/or by vehicle composition (see subsection 3.6.2). Depending on the type of vehicles that are utilized in railway operations, the different alternatives allow a much-simplified approach. In the case of the dynamic DRP deployment system, since the vehicles and

vehicle compositions (see subsection 3.6.2) are overall uniformed across the network, the second alternative is recommended.

- *The number and type of vehicles present in each parking location:* the presence of any vehicles or vehicle compositions in these locations
- *Passenger handling potentials:* if the parking track is able to host passengers or not

With the additional attributes included in regular station nodes, the parking locations within the network can be adeptly modelled for the purposes of the dynamic DRP deployment system.

5.2. Original Schedules and Circulation Plans

As defined in subsection 3.5.2, the original schedule and circulation plans respective to all lines l that operate in the commuter railway network, and belong to the set of all lines J , must be recognized. The original schedule and circulation plans are central as they constitute the main objects to be processed by the dynamic DRP deployment system. As discussed in subsection 3.4.2, the means to attain the targeted train number and minute-specific conflict-free schedule entails addressing the two disruption-management problems addressed by the system, namely, the adjustment of both the schedule and circulation plans.

The original schedule and circulation plans for the railway network under investigation are characteristically available in the traffic management system. While their incorporation in the dynamic DRP deployment system does not involve any extraordinary condition, the general requirements aligned with the system requirements are laid out in the following paragraphs.

In the case of the dynamic DRP deployment system, the incorporation of the original schedule and circulation plans must match the day of the week in which the system is being deployed. This implies that both the original schedule and the circulation plans of every line in the commuter railway network must be incorporated for the respective day of the week from the beginning until the end-of-day operations, as defined by the system's requirements (see subsection 3.4.2).

Furthermore, the original schedules and circulation plans are incorporated separately for every vehicle or vehicle composition and acknowledging the specific line to which they belong. Handling the information with this granularity supports the processes in later modules to fulfill their tasks, as foreseen by the system's general approach (see subsection 3.5.2). The general structure of both data arrangements, namely, schedule and circulation plans, has been detailed in subsection 3.6.2, and no prior handling process or alteration needs to be conducted.

Additionally, also aligned with the system requirements (see subsection 3.4.2), the schedules from other types of railway traffic that directly interact or operate in the vicinity of the commuter railway network under investigation must also be incorporated in the system. These schedules should also correspond to the day of the week the system is being implemented, and if possible, include any short-term modification that may have been introduced.

Moreover, as highlighted by the model of Nakamura et al. (2011) and discussed in subsection 3.6.2, the information regarding the original schedule must be complemented by detailing the existence of any corresponding lines (l_{cn}^c ; where c represents the correspondence with a different line or lines) within the network. This information would allow ascertaining the capability to conduct any potential exchange of vehicles or vehicle compositions between lines (see subsection 3.6.2).

5.3. Disruption Programs (DRPs)

Each commuter railway network has its own unique set of DRPs, which are specifically tailored to deal with different disrupted scenarios. As such, DRPs are essential input elements within the dynamic DRP deployment system. The information conveyed within each of the programs outlines a set of operational constraints and line-specific measures that allow tackling the disruption. Thus, in what would otherwise be a highly complex problem, a prompt network-wide evaluation of the disrupted operations can be conducted thanks to the availability of the DRP operating concepts.

The detailed characteristics of DRPs have already been discussed in detail within subsection 2.3.3. Overall, they comprise a set of pre-assessed operating concepts matched to a specific disrupted scenario within their network. The operating concept is detailed for every line affected by the disruption and describes the necessary changes to its scheduled operations. The changes are determined through the implementation of dispatching measures so as to make the overall operation compatible with the disrupted network's capacity (see subsection 2.3.3).

The information inscribed as part of DRPs is specific for every affected line l within the broader set of lines J . For each of the affected lines l , the information can be divided into two categories: the DRP relevant infrastructural elements and the changes to their original operating concept (i.e. train services and circulation plan). The information contained within each of these categories is further discussed in the following subsections.

5.3.1. DRP Relevant Infrastructural Elements

At the outset, the infrastructural elements relevant to a DRP operating concept can be often found in the network's core area (see subsection 3.6.2). The infrastructural elements within the core area are of special importance to the disruption-management process due to the high probability of overlapping routes of different lines (i.e. high-density traffic) and their intrinsic importance for passenger transport purposes. Figure 5.3 displays a great example of a network's core area between stations A and G. Additionally, in figure 5.3, the trunk line of the network can also be appreciated between station A and E (see subsection 3.6.2).

As discussed in subsection 3.7.2, the infrastructural elements relevant to a DRP depend on the nature of the measures utilized to develop the operating concepts of the affected lines (see table 2.4 – subsection 2.3.3). Figure 5.3 depicts how specific measures can affect the identification of the relevant infrastructure elements by utilizing four different DRPs applied in two slightly different versions of a sample network.

By considering all potential measures that can be utilized in the development of DRP operating concepts, which have been discussed in subsection 2.3.3, three infrastructural elements become relevant for each of the network's affected lines. The three line-specific infrastructural elements are:

- Station(s) assigned as DRP turning stations, regardless of whether or not they are part the considered railway network (these are considered as temporal end stations for the affected lines)
- Station(s) and sections of a line's route that are cancelled
- Station(s) or points(s) where a line is deviated from its original route

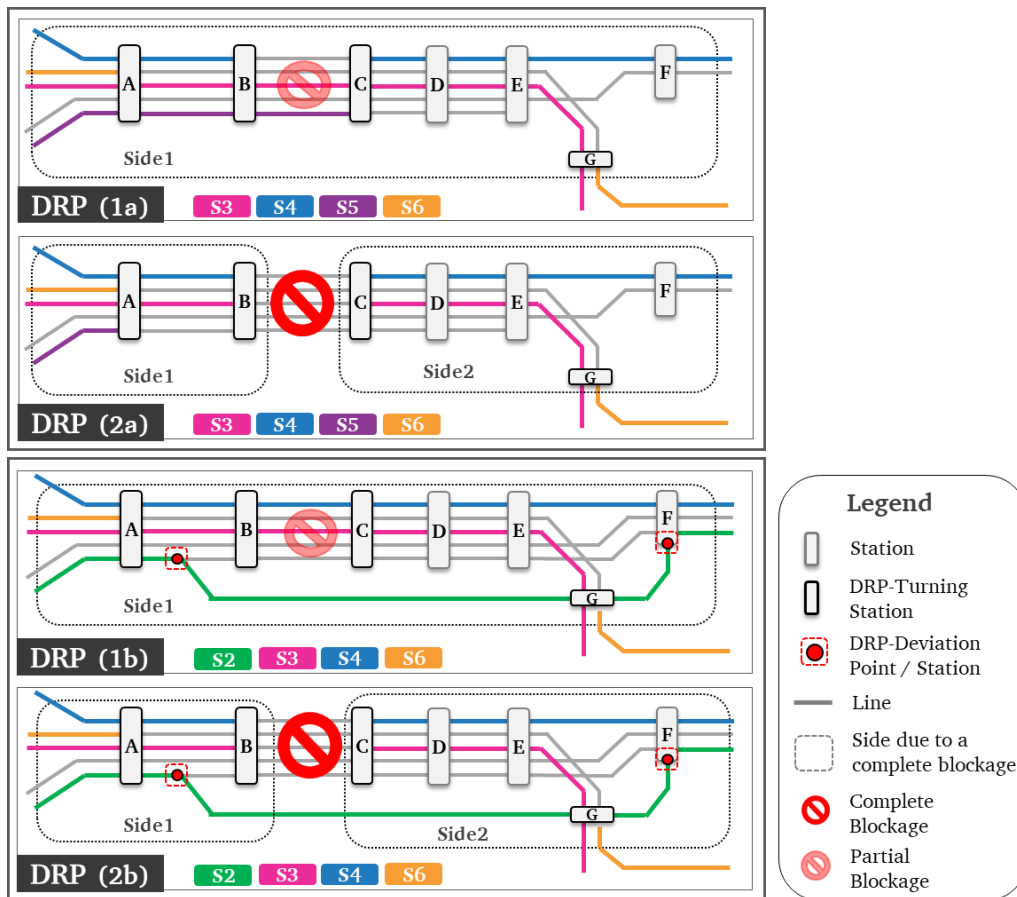

Figure 5.3 Examples of the differentiation of lines between sides in correspondence to their DRP operating Concept and the magnitude of the disruption (by author)

The disruption induced operating situation of an affected line l , as reflected by the chosen DRP operating concept and the magnitude of the disruption (i.e. complete or partial blockage of a section - see subsection 3.7.2), may require making further differentiation on the DRP relevant infrastructural elements. The disruption induced operating situation is explained by the need to establish different sides l_s for the same line, as discussed in subsection 3.7.2. For this task, six distinct possibilities are recognized and exemplified, utilizing figure 5.3.

- i) The network is separated into two different sides due to a complete blockage of its infrastructure, and the DRP operating concept foresees the division of an affected line l into different sides l_s . These circumstances are depicted in ‘DRP 2a’ and ‘DRP 2b’ by lines S3, S4 and S6.
- ii) The network is only affected by a partial blockage of its infrastructure, nevertheless, the DRP operating concept foresees the division of an affected line l into two different sides l_s . These circumstances are depicted in figure 5.3 – ‘DRP 1a’ and ‘DRP 1b’ by line S6.
- iii) The network is affected by a complete blockage, which leads to its separation into two different sides. As a result, the DRP operating concept foresees the deviation of an affected line l so that it is able to reach the opposite side. This is depicted in ‘DRP 2b’ by line S2. In case, the line is not divided into different sides, the term S in l_s remains equal to 1.
- iv) The network is only affected by a partial blockage of its infrastructure yet, the DRP operating concept foresees the deviation of an affected line l so that it is able to bypass the disrupted section. This situation is displayed in ‘DRP 1b’ by line S2. As in case iii), the term S in l_s remains equal to 1.

-
- v) The network is affected by a complete blockage, which leads to its separation into two different sides. As a result, the DRP operating concept foresees the division of an affected line l into two different sides l_S , however, in one of the line's sides, the service is cancelled. This case is depicted in 'DRP 2a' by line S5. Under these circumstances, the cancelled section of the line is still referred to as l_S .
 - vi) The network is only affected by a partial blockage; however, the DRP operating concept foresees the shortening of an affected line l . This case is depicted in 'DRP 1a' by line S5 and as in case *iii*), the term S in l_S remains equal to 1.

The above-described cases, utilizing the four slightly different DRPs displayed in figure 5.3, permit to differentiate the network elements relevant to DRPs for all the affected line and sides l_S .

5.3.2. Changes in the Original Operating Program

As discussed in subsection 2.3.3, the ability of the disrupted network to reach a stable operation is contingent on the degree to which its operations are made compatible with the limited capacity of the available infrastructure. Therefore, the DRP operating concept not only introduced measures that allow lines to either avoid or overcome the disrupted section but also introduces measures that modify their operating programs, making them compatible with the disruption (see subsection 2.2.1).

As discussed in subsection 2.3.3, the DRP operating programs are developed by introducing and subsequently verifying measures that are appointed to each of the affected lines in the network. An analysis of the utilized line-specific measures summarized in table 2.4 (see subsection 2.3.3) highlight two important modifications to the original operating program of every line:

- i) Train services in the original schedule that need to be cancelled and the resulting service interval for every line.
- ii) Changes on routes and platforms tracks throughout all stations are incorporated (i.e. aligned with the DRP relevant infrastructural elements – see subsection 5.3.1) vis-à-vis those assigned in the original schedule.

A third element must also be considered during the actual implementation of the line-specific measures, namely, the need and availability of special train numbers. Special train numbers are made available for the affected network, which allows an immediate implementation of the line-specific measures to train services that must be simultaneously serviced by different vehicle compositions on the different sides of the disrupted network (see subsection 3.6.2).

The above-discussed modifications must also be differentiated between affected lines' sides l_S , as detailed by the six cases in subsection 5.3.1.

5.4. Disruption Information

The above-discussed data arrangements represent the actual operating situation of a network and its pre-planned disruption coping mechanisms. The static input elements provide the necessary means to appreciate and locate the impact of the disruption in the network with enough precision for an immediate assessment of its operating condition.

Before any information from the actual operating situation can be captured, two important tasks must be successfully completed. First, the disruption must be assessed. This entails identifying the

reason, location, and extent of the disruption, as well as establishing an estimated disruption length t_{EDL} in time. Secondly, the DRP that best matches the assessed situation is selected from the network's set of available DRPs, which allows ascertaining the operating concept being deployed by the system. As discussed in the system limitations (see subsection 3.3.2), the two tasks described above are not included in the scope of the dynamic DRP deployment system and should thus be considered as additional input elements.

Ultimately, before the information regarding the actual situation of the network can be fully collected, a new benchmark within the dispatching time of the traffic management system must be imposed. The deployment time of the dynamic DRP deployment system t_0 is made equal to the time in the traffic management system when the DRP was selected. This temporal value assigns the starting point of the dynamic DRP deployment system as part of its decision-support roles. With the establishment of a deployment time, the temporal aspects of the network's scheduled operations may be ascertained. Therefore, the deployment time must fall within one of the three temporal categories (i.e. HVZ; NVZ and SVZ), recognizing the time of day (see subsection 3.6.2). As a result, $t_{0,TD}$ is further recognized as to be contingent on the time of day; for example, if the dynamic DRP deployment system is deployed during the peak hour, the deployment time is recognized as: $t_{0,HVZ}$.

Once the disruption has been assessed and a DRP identified, the disruption information can be captured. The scope of the captured information has been detailed in the approach (see subsection 3.5.2). It covers all of the immediately affected elements, namely, the infrastructure and all circulating trains in the network. This allows deriving the key information and acquiring an overview of the actual operating situation.

5.4.1. Infrastructural Situation

As a disruption affects a particular section(s) of the infrastructure across the network, the following characteristics may be immediately ascertained:

- i) *Location of the disruption:* as already acknowledged in the assessment of the disruption, every single affected infrastructural element (i.e. switching zones, platform track groups, or link) is identified in the infrastructural model.
- ii) *Extent of affected infrastructure:* the attributes of the already identified elements are updated in the model. For example, if the disruption has left a switch or a group of switches within a switching zone inoperative, the corresponding relations in the matrix of relations (Matrix E, see subsection 2.2.2.) must be adequately updated.

In addition, as discussed in subsection 5.3.1, depending on the extent of the disruption, that is, a total or partial blockage, the affected rail network can be divided into two isolated sides (see also subsection 3.7.2). However, regardless of the magnitude of the disruption, the railway operations around the affected section are compromised and must be adjusted to be compatible with the available infrastructure. Existing models aligned with both ad-hoc and planned disruption-management approaches discussed throughout subsection 2.3 highlight the relevance of the turning stations located near the disrupted section for the management of the disrupted operations. Turning station located near the disrupted section provide dispatchers with a range of alternatives to handle trains that run the risk of generating a queue as they approach the disruption. Therefore, the system should identify the following two additional attributes in the infrastructure:

-
- iii) *Last technically feasible turning stations (LtfTS)*: as detailed in subsection 3.6.2, these are the stations on either side of the disrupted section located the closest to the affected section and constitute the last possibility for trains to change their driving direction.
 - iv) *Critical area*: as detailed in subsection 3.7.2, the critical area covers all infrastructural elements between the disrupted section and an adjustable number of turning stations prior to the LtfTS.

5.4.2. Trains

The infrastructural situation permits to ascertain the actual condition of all trains circulating in the network. Here, a distinction must be made between the information that may be acquired for all trains circulating in the commuter railway network and the information of trains from further railway traffic.

Aligned with the systems requirements (see subsection 3.4.2), the information respective to the trains circulating in the commuter railway network must be captured for every single train T_{l_s} that services a line l and finds itself on side S (if applicable). This information would most likely need to be attained from the traffic management system.

In overall, four attributes normally captured by the traffic management system that can be registered by relying on the system's deployment time $t_{0,TD}$ as a benchmark, may be identified:

- i) *General Information of a train*: train number (i.e. current train service), corresponding model train, number of vehicle units, the total length of the train, and the number of drivers (see Chu 2014, p. 48).
- ii) *Circulation Plan*: the circulation plan of every vehicle in the vehicle composition (i.e. all transition train services), the station where each vehicle is scheduled to finalize its duties and its parking location according to the next day of operations (see subsection 2.3.3 and 3.6.2).
- iii) *Actual location in the network*: The position of each train is recorded at $t_{0,TD}$ as their actual location in the infrastructure.
- iv) *Actual delay*: the delay derives from comparing the train's location dictated by the original schedule with its actual location at $t_{0,TD}$, which is recorded and considered as an initial delay t_v for the dynamic DRP deployment system.

Finally, for a complete overview of all vehicles within the commuter railway system, the vehicles at the network's parking locations must also be considered. All of these vehicles and their actual location are recorded, distinguishing those with immediate service availability, as detailed in subsection 3.5.2.

Regarding trains from other types of railway traffic and or other railway companies, depending on the availability of the information, their operating information can be incorporated in the system or not. If information is available, it can only be introduced in the system if it covers the minimum required information. The minimum required information is constituted by: the schedule and the information respective to the above-explained attributes: *i*) and *ii*). It must be noted that only the interaction between other types of railway traffic or other railway companies and the commuter trains is supported by the dynamic DRP deployment system (see subsection 3.4.2).

5.5. Closing Remarks

This section detailed the nuances regarding both the static and dynamic data arrangements, which are the inputs required to bring the dynamic DRP deployment model into action. Each of the above-discussed elements is aligned with the system's requirements and limitations detailed in sections 3.3.2 and 3.4.2. Gathering these inputs permits the dynamic DRP deployment system to begin with the implementation of the line-specific measures within the chosen DRP specifically targeted to the disrupted situation.

6. Elemental Conflict Solution Alternatives

6.1. Introduction

The elemental conflict solution alternatives discussed in subsection 3.6.2 provide an overview of the dispatching measures with the capability to address the disruption-management problems being handled by the dynamic DRP deployment system (see subsection 3.4.2). With an understanding of all conceivable solution alternatives, the dynamic DRP deployment system can determine better-focused resolution alternatives to cope with the disruption. Therefore, before carrying out any process to address the actual operating situation of the disrupted network, every elemental conflict solution alternative that can be implemented for the handling of degraded operations should be contemplated. This subsection incorporates the dispatching measures detailed in subsection 3.6.2 and seeks to establish the predefined elemental conflict solution alternatives as well as respective bundles of relevant measures that would allow addressing each of the conflict types, aligned with the system's general approach subsection 3.5.2.

As described in subsection 3.5.2, by including the line-specific DRP operating concept in the system, the foreseen approach projects the utilization of a CDCR process across two operational levels (i.e. line-specific and vehicle-specific). In this regard, the system traverses from first considering operational obstacles that can only be addressed by contemplating a line in its entirety, towards a vehicle-specific level in an attempt to find the most suitable measures for all trains circulating in the network as part of its objective to establish a conflict-free schedule. The division between line and vehicle-specific issues allows the proposed system to embrace actual dispatching practices and expand the considerations of disruption-management systematically across the whole network to address the adjustment of the schedule and circulation plans simultaneously.

In general, predefined elemental conflict solution measures are used to address specific conflict types in railway operations. Measures are bundled in groups to establish alternatives to solve different conflicts as a product of their implementation (see subsection 2.2.3). Every resulting bundle of predefined measures constitutes the basis for the development of conflict solutions during the CDCR process of each of the addressed conflict types. The main objective of this section is to examine and bundle the dispatching measures detailed in subsection 3.6.2 so as to address the six conflict types being handled by the dynamic DRP deployment system across both of its operational levels (see subsections 3.5.2 and 3.5.3). At the line-specific level, two conflict types are handled by the system, namely, vehicle availability and reachability conflicts. At the vehicle-specific level, four conflict types are handled by the system, occupancy, infrastructure availability, circulation and service conflicts

As discussed in subsection 2.2.3, elemental conflict solution alternatives are primarily bundled by conflict types. Incorporating a distinction between line and vehicle-specific operational levels would constitute a new determining variable influencing the examination of the measures and their subsequent arrangement into bundles. As such, the need to address different conflict types on more than one operational level makes it indispensable to discuss the boundary conditions and combinability of the measures for the establishment of the measure bundles. For that reason, the elemental conflict solution alternatives discussed in subsection 3.6.2 should be examined in detailed and subsequently bundled vis-à-vis their ability to address the operating situation induced by a certain specific conflict type at every operational level.

This subsection is divided into two overall tasks. Initially, the elemental conflict solutions are examined in detail for their subsequent arrangement into measure bundles. A structured approach is required for allowing to conduct a systematic and generally valid examination of all considered solution alternatives. An approach with a similar objective and in a similar implementing field has already been advanced in Stelzer (2016). Secondly, after examining the elemental conflict solution measures and their proficiency in addressing each of the conflict types across the two operational levels, these are pulled together in measure bundles.

First, subsection 6.2 introduces the structure of the existing approach proposed by Stelzer (2016) to examine the elemental conflict solutions and stipulates the modifications needed to make it compatible with this work. Subsequently, building upon the approach described in 6.2, a close examination of the measures detailed in subsection 3.6.2 is presented in subsection 6.3. Later, subsection 6.4 details the bundling of the relevant elemental conflict solution alternatives for both conflict types within the framework of the line-specific operational level. Then, the bundle of elemental conflict solution alternatives for the vehicle-specific operational level across all four conflict types is introduced in subsection 6.5. The bundle of elemental conflict solution alternatives derived as a result of this section permits to establish the predefined solution alternatives for the CDCD processes advanced on the two operational levels discussed in subsection 3.5.2.

6.2. Structured Examination Approach

As a first step, a framework for the systematic examination of the elementary conflict solution alternatives is established. To this end, an existing framework from Stelzer (2016) is fit to conduct a structured and systematic examination of conflict resolution measures as part of decision-support systems inscribed within CDCR principles.

6.2.1. Existing Examination Framework

The examination framework presented in the work of Stelzer (2016) was utilized to examine dispatching measures to address connection conflicts as part of a real-time semi-automated system built around a heuristic CDCR process (see subsection 2.2.3). Overall, the framework contemplates six features that allow examining every elemental conflict solution measure. The examined features stand as follows (see Stelzer 2016, p.98-100):

- *Description of the type of actions and possible impact:* an overview of the measure and its effects on the operation is provided.
- *Check for feasibility and quantification of possible effects of the measure:* the constraints (i.e. implementation requirements) in which the measure is applied are examined, and a description of the measure's handling of the conflict is given.
- *Combinability:* since more than one measure can be used at the same time, the potential combination of the measures with different alternatives is explored. In many cases, the combination of measures is the only path toward solving a given conflict, demonstrating the importance of considering its combinability with other measures.
- *Determining variables:* the different quantities that can be used to assess the implementation of the measure are identified. A generalized subdivision of potential determining variables into general categories is introduced, the categories are valid for the examination of all measures.

-
- *Robustness of the measure*: the implementation or dispatching robustness of a measure is observed as well as the risk engendered on subsequent dispatching processes.
 - *Dispatching time*: every measure has a particular implementation time. The respective timespan is imposed to highlight the moment in which the measure can be implemented.

6.2.2. Modification of the Existing Framework

The examining framework described in Stelzer (2016), enables a systematic assessment of the elemental conflict solution alternatives described in subsection 3.6.2. Nevertheless, there are underlying differences between the problems and the implementing context dealt with in this work and the one in Stelzer (2016). Consequently, the above-described framework must be adjusted accordingly.

The most immediate differences are the problems being tackled within each work. Stelzer (2016) examines a collection of measures to tackle one single conflict type (i.e. connection conflicts), whereas the dynamic DRP deployment system covers six different conflict types (see subsection 3.6.2). However, the differences go beyond the multiplicity of the handled conflict types to the inclusion of two different operational levels within the dynamic DRP deployment system (see subsection 3.5.2). Moreover, the implementing context of handling disruption in passenger railway networks is valid in both approaches. Despite this fact, the decision-support model developed in Stelzer (2016) develops a real-time monitoring of connection conflicts, whereas this work seeks the immediate readjustment of the schedules.

The examining framework proposed in Stelzer (2016) is modified in line with the remarks made above. This implies rearranging the framework to include the different operational levels as well as conflict types and modifying the perspective of the examination from a real-time monitoring to a decision-support for train dispatching during disrupted operations.

The six features used to perform the examination are maintained. Nevertheless, the overall framework is modified, shifting the examination to the robustness of the measure as a prelude to analyzing the determining variables. The necessary modifications to each of the features are as follows:

- *Description of the type of action and possible impact*: the core principle is maintained; however, the description of the measures are extended to include the application across the different operational levels and across conflicts types.
- *Check for feasibility and quantification of the approach*: since a measure can be utilized within more than one conflict type and possibly across operational levels, this must be reflected in the examination of its constraints (i.e. prerequisites for its implementation) as well as the description of its solution approach.
- *Combinability*: the combinability of measures must be evaluated within each of the applicable conflict types, as evidenced by feature one, providing an overview of the possible combinatorial alternatives.
- *Robustness*: in the scope of this work, the robustness of the implementation of a measure shift towards observing its influence on the operating situation once it is implemented.
- *Determining variables*: the core principle is maintained; nonetheless, the subdivision of potential determining variables into general categories is aligned with the scope of this work. The introduced categories must strive to cover the widest range of potential effects produced by the measures on the operating situation of the disrupted network.

Furthermore, the categories must be aligned with the development of an evaluation function that supports the properties discussed in subsection 3.5.2 and the disruption-management problems covered by the dynamic DRP deployment system (see subsection 3.4.2). As evidenced throughout the discussion of existing heuristic models aligned with a CDCR process and their assessment framework, the determining variables may be distinguished in temporal, spatial, look-ahead, and other measure-specific effects that influence the operations of the railway system or the disruption-management (see subsection 2.2.3 and 2.3.2).

As a result, four general categories are introduced:

- *Temporal*: focuses on the effects produced by the temporal adjustments, which are produced by a measure on the originally scheduled operations, namely, train delays.
- *Spatial*: focuses on the effects produced by the spatial adjustments produced by a measure on the originally scheduled operations. Here, as supported in existing models, the determining variables support (see subsections 2.2.3, 2.3.2 and 2.3.3): changes in platform tracks as well as changes in routes. However, given the existence of the DRP operating concept, the changes in DRP relevant infrastructural elements (i.e. DRP turning stations) must also be considered.
- *Look-Ahead*: focuses on any follow-up conflict that may be generated by a measure. Here the determining variables must support any conflict that may be potentially induced by the adjustment of the schedule, namely, occupancy, circulation and service conflicts.
- *Malus*: focuses on any relevant effect of the measure on the quality of service or the disruption-management problems addressed by the system. Here, any effect on the service quality and the indirect disruption-management problems handled by the system (see subsection 3.4.2) become relevant, namely, the number of cancelled stops, train service cancellations, and end-of-day imbalances.
- *Dispatching time*: in this work, the implementation time of every measure should be observed in correspondence to the system's deployment time $t_{0,TD}$ so as to ascertain the limit to the moment in which a measure can be implemented (see subsection 5.4). As a general rule, a specific measure can only be allocated beyond the interval between the system's deployment time $t_{0,TD}$ and the minimum communication time $\min t_{Comm}$ to ensure that the necessary orders can be successfully transmitted to the involved staff members.

With the modifications introduced in the examination framework, the available measures can now be adeptly evaluated within the context of the dynamic DRP deployment system. The examination of each one of the measures will illuminate their implementation adeptness within the respective operational level and conflict type; ultimately, supporting their subsequent clustering into a bundle.

6.3. Evaluation of the Elemental Conflict Solution Alternatives

In this subsection, the already modified approach detailed in subsection 6.2 is implemented for all fourteen elemental conflict solution alternatives detailed in subsection 3.6.2.

6.3.1. Exchanging a Train Between Lines – (ETL)

Description of the type of action and possible impact

As described by its name, the measure exchanges a vehicle composition from one affected line to another. The implementation of the measure solves two problems simultaneously, the surplus of available vehicles on the source line, or the line's side (if applicable), and the lack of available vehicles on the receiving line.

The measure deals with the reallocation of available vehicle resources with respect to the DRP operating concept of each of the affected lines and sides (if applicable) (see subsection 5.3 and 5.4). Since the measure can be allocated to any of the trains circulating in the network servicing a line with a surplus of vehicles, the measure stays within the line-specific operational level and capable of solving both vehicle availability and reachability conflicts, as discussed in subsection 3.6.2.

Check for feasibility and quantification of the approach

Prerequisites for its implementation:

Exchanging a train between lines is highly contingent on the investigated railway network. As explained in subsection 5.2, for commuter railway systems, the original schedule identifies specific lines l that are able to exchange vehicles between each other and recognizes them as corresponding lines l^c . Therefore, regardless of the magnitude of the disruption (complete or partial blockage), vehicle resources can only be exchanged between corresponding lines l^c as indicated by the original schedule (see subsection 5.2).

Moreover, Stelzer (2016, p.130) describes additional operational matters that must be observed before the exchange is conducted: the driver must be entitled to operate along both of the lines' routes, and the vehicles must be approved for their utilization across the infrastructure (i.e. gauge, energy supply and train protection technology).

Last but not least, the measure can only be considered in cases where, as a product of the stipulated changes in the DRP operating concept of the corresponding lines, for the same side in a disruption divided network, one of the corresponding lines l^c has a lack (i.e. receiving line) of vehicle resources and the other a surplus (i.e. source line) of vehicle resources.

Solution approach:

Initially, depending on the layout of the network and the magnitude of the disruption, portions in which the routes of the corresponding lines effectively overlap must be established. Any train services in the source line which is able to access the overlapping route may be appointed with the measure. In case of a disrupted situation, trains that already find themselves on the overlapping portion of the corresponding lines' route (within the dispatching time limitations) or are able to reach it without having first to change their driving direction (see subsection 6.2.2) constitute particularly relevant alternatives. This would allow the system a faster transition to stable operations by means of a fast reallocation of vehicle resources.

Once a specific train service in the source line has been established, the measure removes its appointed train service and circulation plan. The original train service is removed from the point in which the exchange to the corresponding line is set to take place. Later, a new train service and circulation plan respective to the receiving line are appointed to the train. The train service and

circulation plans are appointed to the train such that by the time the measure is implemented, they have not been appointed to any other train. However, particular attention must be given to complete blockages or when the DRP operating concept foresees the division of a line into two different sides. This is the case as special train numbers may be utilized to appoint the same train service to different trains on both sides of the disruption (see subsection 5.3.2).

Combinability

Exchanging a vehicle between lines is a measure that can be combined with any other measures from the line-specific operational level to effectively solve vehicle availability and reachability conflicts throughout more than one affected line and side (if applicable).

Ultimately, the implementation may lead to the partial cancellation of portions of the originally scheduled route of the train being exchanged between lines. Therefore, the partial cancellation of train services is an inherent consequence of the implementation of the measure (see subsection 6.3.5).

Robustness

Exchanging vehicles between corresponding lines allows reallocating vehicles and vehicle compositions that otherwise would be removed from the network. Once implemented, the measure has the potential to be rectified in subsequent operational decisions. For example, if a line has one of its vehicles changed to a different line, the vehicle can still be removed from the system or switched back to its original line. However, this can only be done once it has completed its assigned train service or at the expense of the passengers' welfare. Overall, once implemented, the measure does not impose a robust influence on the operating situation.

Determining variables

The type of action and overall approach of the measure are appraised within the framework of the four determining variable categories discussed in subsection 6.2.2.

On the one hand, the measure does not produce any direct spatiotemporal adjustment on the train services of a line. However, since it exchanges a vehicle at a certain location of its route, the following parameters may be observed:

- Follow-up service conflicts (Look-Ahead)
- Change of turning station (Malus)
- Number of cancelled stops (Malus)
- End-of-day imbalance (Malus)

Dispatching time

The exchange of a train between corresponding lines can be conducted without any further limitation.

6.3.2. Incorporating an External Train – (IET)

Description of the type of action and possible impact

This measure contemplates appointing a train service and circulation plan from a given line to a vehicle composition that is located in a parking location (i.e. outside the network). Therefore, an additional train is incorporated in the system in an effort to address the lack of available vehicles

of a specific line and side (if applicable) due to the disrupted operations of the railway network. The incorporation of a train involves taking close attention to the availability of resources at the receiving line and at the parking location (i.e. vehicles and crew).

The measure is exclusively targeted at dealing with the lack of available vehicles to service the DRP operating concept of an affected line and side (if applicable) (see subsection 5.3 and 5.4). As with the exchange of trains between corresponding lines, the vehicle composition being introduced can be assigned to any train service and circulation plan available. Therefore, the measure is particularly relevant at the line-specific operational level and capable of solving both vehicle availability and reachability conflicts.

Check for feasibility and quantification of the approach

Prerequisites for its implementation:

The measure is built over three overall prerequisites. First, as a product of the stipulated changes in the DRP operating concept and the disrupted circumstances, there must be a line and side (if applicable), with a lack of vehicle resources.

Second, the existence of a vehicle or vehicle composition with service availability around the parking locations. The service availability of a vehicle has been discussed in detailed in subsection 3.6.2. Overall, a vehicle is considered to be available for service if it fulfills technical, operational and transport conditions. While technical and operational conditions must be upheld regardless of the situation, transport conditions, which safeguard service standards (e.g. preheated vehicles,) may be left aside in case of disrupted operations. This is the case since the effect on the quality of service would be much dire if train services need to be cancelled due to a lack of vehicles.

Third, the vehicle composition requires to be appointed with: a train service, a circulation plan and a platform track at a specific station where is set to begging its service. It must be highlighted that the selection of a beginning station is largely dependent on the train service that can be potentially appointed to the vehicle.

Solution approach:

Initially, for an affected line with a lack of vehicle resources, the exploration of external vehicle compositions with service availability is conducted throughout all parking locations accessible from its route. Once vehicles or vehicle compositions with service availability have been identified, they must be appointed a train service and circulation plan, which by the moment the measure is implemented have not been appointed to any other train respective of the line and side (if applicable). Among the possible train services that can be assigned, any train service in the DRP operating concept or those product of reachability conflicts can be considered. However, particular attention must be given to complete blockages or when the DRP operating concept foresees the division of a line into two different sides as this would allow establishing the need to utilize special train numbers, as discussed in subsection 6.3.1.

Just as with the selection of a train service and circulation plan, a station and platform track where the train service is set to start its service must be carefully selected. In a disruption, the station and platform track are preferably located the closest to the actual parking location of the vehicle composition to be incorporated and can be immediately accessed (i.e. without the need for change in the driving direction).

Once the train service and starting platform track at the selected station have been assigned to the vehicle combination, the necessary shunting movements from the parking location to the respective platform track must be generated. These movements may be scheduled as normal train journeys starting from the parking location until the platform track at the station where the train service starts its operations. The shunting movements must be scheduled, providing the train with an alternative train number to recognize its movement throughout the network.

Combinability

The incorporation of a vehicle in the network allows addressing the lack of vehicles for a given line or line's side (if applicable). Therefore, it can be combined with other measures at the line-specific operational level in order to deal with a lack of vehicle availability and at the same time, reachability conflicts of an affected line and side (if applicable). Thus, the measure can be combined with an exchange of trains between lines (subsection 6.3.1).

Robustness

The introduction of a vehicle in a disruption allows upholding the serviceability of an affected line and side in a disruption divided network. The measure is beneficial as it provides the line with the vehicle resources to uphold its service capabilities, yet its benefits come in detriment of the vehicles' management like a potential generation of end-of-day imbalances, as discussed in the previous measure.

As with the exchange of trains between corresponding lines, the incorporation of a vehicle composition into the network as a dispatching decision has the potential to be rectified. If needed, once incorporated, the vehicle can be transferred to a corresponding line (if available) or returned to a parking location. However, this must be conducted, taking into consideration the already appointed train services and circulation plans, which have already been assigned to the vehicle. Thus, once implemented, the measure imposes a moderately robust influence on the operating situation.

Furthermore, since incorporating a vehicle requires aligning crew and vehicle resources, which were not originally scheduled to operate, a reliable timeline for the measure's implementation cannot be accurately projected. Thus, the implementation of the measure is not as reliable as other alternatives explored in this subsection (e.g. exchange a train between lines).

Determining variables

The incorporation of external vehicles in the network has a positive effect on supporting a transition of the disrupted network to stable operations. However, once its type of action and overall approach are appraised in each of the four determining variable categories discussed in subsection 6.2.2, the following determining variables become relevant.

The measure does not produce a direct spatiotemporal effect on the railway operations. Additionally, its implementation does not induce any immediate follow-up conflict. However, since it appoints a schedule and a circulation plan to a vehicle that was not originally scheduled to be introduced in the network it inherently may induce an end-of-day imbalance. Therefore, the following parameter may be observed:

- End-of-day imbalance (Malus)

Dispatching time

As discussed in the “Robustness” subtitle, incorporating a parked vehicle requires a constant communication flow with personnel throughout the different parking locations around the network. Therefore, the implementation of this measure must take into consideration not only the minimum communication time $\min t_{comm}$ to ensure that the necessary orders can be successfully transmitted to all the involved staff members, but also a timeline to establishing the departure time of the train from the parking location towards the platform track at the selected station.

6.3.3. Removing and Parking a Train – (PT)

Description of the type of action and possible impact

This measure is utilized to remove a train from circulation and route it towards a parking location around the network. Removing a train proves beneficial to equate the capacity of the disrupted infrastructure with the traffic in circulation. The promptness with which the capacity of the disrupted infrastructure can be equated with the traffic in circulation depends on the distance of trains from their potential parking location(s).

The removal of a train out of circulation is mainly determined by a surplus of vehicle resources for servicing the DRP operating concept of an affected line and side (if applicable) (see subsections 5.4 and 5.3). Since it is possible to assign the measure to any of the trains of a line with a surplus of trains, it is by nature line-specific, and most concretely, it has the capability to address vehicle availability conflicts.

Check for feasibility and quantification of the approach

Prerequisites for its implementation:

The measure can be implemented in cases where, as a product of the stipulated changes detailed in the DRP operating concept of an affected line, the number of trains needed to service the targeted operating concept is less than the number of trains in circulation.

The systematic removal of surplus trains from the network requires the establishment of the parking availability at the locations established by the DRP operating concept of a line. However, it is possible that the operating concept does not count with this information, in which case, it is necessary to explore the parking availability across parking locations that are accessible to the trains of a conflicting line per side (if applicable). The parking locations being explored must be accessible given the actual infrastructure availability across the network and must be able to host the number of vehicle compositions that ought to be removed.

As discussed above, from a network capacity standpoint, the preferred alternative for the parking of a train during a disruption would be in any parking location located close to a train, which can be accessed without the need to change its driving direction. However, if there are no parking locations available or accessible, the parking may also be carried out on a platform track at a station.

In the dynamic DRP deployment system, parking locations across the network are referred to as being conventional and unconventional (see subsection 3.7.2).

Conventional parking locations are specific for every line and refer to parking locations normally utilized by its vehicles in correspondence to the time of day. Parking locations detailed in the DRP

operating concept are also recognized as being conventional parking locations. However, in order to allow a much more comprehensive exploration of potential parking locations, all parking locations within the commuter railway network that can be immediately accessed (i.e. without the need of a deviation) along a line's route from both driving directions are also referred to as conventional parking locations.

On the other hand, unconventional parking locations are constituted by parking locations that: require a deviation of the trains away from their original route, are located outside of the commuter railway network or are not normally utilized for parking purposes (e.g. platform track elements in stations not explicitly considered as parking location by the DRP operating concept).

Furthermore, for the removal and parking of trains, the locations in which crew members are scheduled to finish their respective shifts is also a relevant aspect to consider. However, as established in the limitations and requirements of the system (see subsection 3.3.2 and 3.4.2) and considering the fact that the geographical converge of a commuter railway network is not as substantial as for regional and long-distance railway networks, this problem is not directly addressed. However, as discussed in the system requirements (see subsection 3.4.2), the necessary constraints to ensure trains are able to reach specific locations in the network where crewmembers are being replaced within the duration of the disruption.

At last, if a train is being parked at a parking location, the ability to transport passengers to that location (see subsection 5.1.2) must also be verified.

Solution approach:

The implementation of the measure begins with an exploration of available parking locations across the network. The removal of trains towards conventional parking locations is preferred over unconventional parking locations, as they may be easier to reach, and their availability can be verified with more accuracy (see subsection 5.1.1). Accordingly, the parking availability is first verified throughout all conventional parking locations accessible for a specific line and side (if applicable). Later, if no available parking locations have been established, unconventional parking locations may also be verified.

Depending on the commuter railway network, the verification of unconventional parking locations can be conducted simultaneously across all alternatives. This would entail a parallel verification of the parking availability across potential platform tracks and parking locations that require a deviation of the trains before they can be reached. However, since the utilization of platform track elements for parking purposes may have a considerable impact on the operations at the respective station, the utilization of platform tracks as unconventional parking locations requires thorough consideration.

The potential platform tracks to be utilized for parking purposes may be located throughout the stations of a line and side (if applicable) that are not being serviced as foreseen by the DRP operating concept. The end station of any unserved portion of a line is of particular importance since, in commuter railway operations, an exclusive platform track is typically designated at this station. However, the exploration of potential platform tracks must still be conducted by taking into consideration the scheduled operations at the investigated station for the respective time of the day $t_{0,TD}$ and considering the estimated disruption length t_{EDL} .

Once the different parking locations, whether conventional or unconventional, have been identified, it is possible to establish which of the trains of the conflicting line per side (if applicable) may potentially be removed. Once again, the ability of the network to transition as fast as possible to stable operations is utilized as a baseline to fulfill this task. Thus, all trains that are not only located the closest to the parking location but are also able to access them without the need to change their driving direction would constitute potential alternatives. Ultimately, if all trains require to change their driving direction before they can access one or more established parking locations, the trains that have the least projected arrival at the parking location (including the time required to change the driving direction and empty the train) constitute potential alternatives.

Additionally, if the parking location does not match with the end station of the train's last service or if the parking location is not able to host the transported passengers, it is necessary to schedule additional shunting movements. These shunting movements must be scheduled for the train being removed from the network from its last serviced station to its parking location. The shunting movements are scheduled as normal train journeys, including the minimum time for emptying a train with or without a change in the driving direction at the end station (see subsection 3.6.2), and establishing the most immediate route from the platform track to the parking location. The shunting movements must be scheduled by providing the train with an alternative train number to recognize its movement throughout the network.

Combinability

The measure can be combined with other measures at the line-specific level to address the surplus of vehicle availability of an affected line. Thus, the measure can be combined with an exchange of trains between lines (subsection 6.3.1).

Robustness

The removal of a train during a disruption may be utilized in the processes of equating the overall traffic circulating in the network with its disrupted capacity. The measure is beneficial as it releases infrastructure capacity making it available for other trains, which in turn also has positive effects for transitioning the network to stable operations. Additionally, in planned disruption-management approaches, the effects of a systematic removal of trains from the network have already been verified during the development of the DRP operating concept and supported by the DRP transport concepts (see subsection 2.3.3). Nevertheless, the measure may still have a substantial effect on the operations scheduled for the next day as it would most likely induce end-of-day imbalances after trains are parked in different locations to the ones appointed in their circulation plans.

Furthermore, the negative influence of the measure on the robustness of the network differs if the surplus train has been parked at a parking location or a platform track in a station.

Once a train has been sent to a parking location, its reincorporation in the network after the disruption has been resolved would require longer than that of a train that has been parked at the platform track of a station. Moreover, a train which is sent to a parking location also consumes additional capacity in the infrastructure since shunting movements must be scheduled. Additionally, the negative influence of the measure on the robustness of the network would also differ if the train has been removed with or without passengers. The removal without passengers requires to add to the stopping time a minimum time for emptying the train at the end station.

Therefore, due to the increased stopping time at the end station, the removal of the train without passengers has a further negative influence on the robustness of the network.

On the other hand, if the train is parked at a platform track, its influence would be detrimental to the operating situation in and around the station. However, if the train is parked at a platform track such that its occupancy does not excessively interfere with further operations at the station (e.g. at a platform track in the end station of an unserved portion of the line), the negative influence on the robustness of the network would be much more localized than that of a removal towards a parking location.

Determining variables

Since the dynamic DRP deployment system is advanced within the framework of planned disruption-management approaches, the removal of trains is aligned with the DRP operating concept. Therefore, in case of lines with a surplus of trains if all adept operational means that allow surplus trains to be maintained in the network are explored (e.g. exchange of trains between lines), the effects on the operating situation of the disrupted network are much more controlled. However, once the solution approach is appraised within each of the four determining variable categories discussed in subsection 6.2.2, the following determining variables become relevant.

The measure produces no direct spatiotemporal effect on the railway operations. However, its implementation may produce direct occupancy or circulation conflicts due to the potential need for additional stopping times at a node (e.g. minimum time for emptying the train). Additionally, since the vehicle can be appointed a totally different parking location as the one foresaw in the original circulation plan within an uncertain duration of the disruption, the measure is very likely to induce an end-of-day imbalance. Therefore, the following determining variables may be observed:

- End-of-day imbalance (Malus)
- Follow-up occupancy conflicts (Look-Ahead)
- Follow-up circulation conflicts (Look-Ahead)

Dispatching time

The implementation of the measure requires to establish a parking location to the train considered for removal. Therefore, any parking location that rests within the train's journey time interval equal to the time span between the system's deployment time $t_{0,TD}$ and the minimum communication time $\min t_{comm}$ may not be accessible. This is due to the fact that it cannot be guaranteed that the necessary orders are successfully transmitted to the involved staff members. This restriction can be removed in correspondence to the actual implementation needs of the system.

6.3.4. Transferring a Train – (TT)

Description of the type of action and possible impact

The transfer of a train is a measure that considers the deviation of a train to overcome the disrupted section and reach the opposite side of the disruption divided network. The deviation of the train is conducted through an alternative route that is generally outside the commuter railway network. The measure is utilized to reallocate vehicle resources of an affected line from one side of a disruption divided network to the other in order to service its DRP operating concept.

In large networks, the identification of potential deviation points is a complex task (Stelzer 2016). One way to deal with this situation is through the use of predefined deviation points and routes, as detailed in the guideline of the German infrastructure manager RIL-408 (DB Netz RIL-408 2012). Another alternative is through the pre-emptive or “offline” identification of deviation routes applicable to the chosen DRP operating concept. The offline identification of these infrastructural elements can be done exhaustively and take into consideration the technical and operational compatibility of the deviation routes with the vehicles usually appointed to the train services of the commuter railway network. By combining these approaches, the identification of possible deviation locations can be a highly efficient and effective procedure.

The transferring of a train may be implemented to any of the trains circulating in the network that service a line with a surplus of vehicles on one side and a lack of vehicles on the opposite side. As a result, the measure is line-specific and capable of solving simultaneously vehicle availability and reachability conflicts.

Check for feasibility and quantification of the approach

Prerequisites for its implementation:

The measure can be implemented in situations where, as a product of the stipulated changes in the DRP operating concept of an affected line and side (if applicable), the line has a lack of vehicle resources on one side of the disruption and a surplus of vehicle resources on the opposite side.

The transfer of a train between sides also requires identifying the possible deviation locations (i.e. among those already identified offline for the whole DRP operating concept) that allow linking the routes in both sides of the disruption divided line. In this way, the measure supports the movement of vehicles from a side with a surplus of resources to a side with a deficit of resources.

Furthermore, the measure must also fulfill some practical requirements. The transfer may only be conducted if it is completed in a practical time so that operational stability can be achieved. In this regard, the expected transfer time $t_{trans,exp}$ of a train cannot surpass a maximum transfer time $t_{trans,max}$, as indicated in equation 6.1.

$$t_{trans,exp} \leq t_{trans,max} \quad (6.1)$$

The expected transfer time $t_{trans,exp}$ is the projected journey time for a train accounted since its actual position at $t_{0,TD}$ through the deviating route until its scheduled end station on the opposite side of the disruption. In case the deviation location and route are not included in the predefined network’s guidelines, the journey time through the deviating route may be estimated by relying on a different type of information source (e.g. infrastructural model – see subsections 2.2.2 and 5.1).

Due to the uncertainty in the management of trains during a disruption, it is difficult to estimate the expected transfer time $t_{trans,exp}$ of a train. Thus, this task can be conducted with different levels of detail. As a baseline approach, the overall journey time from a train’s actual location through its deviating route until its end station on the opposite side of the disruption can be ascertained by considering an empty network. However, further details like threading-in as well as threading-out times to and from the deviation route, and the stopping time in intermediate stations may also be included as correcting factors.

The maximum transfer time $t_{trans,max}$ stands as a temporal limit to secure that the transfer of a train is implemented within the boundaries of its practical relevance. For example, if the transfer

time between the sides of the disruption divided network takes longer than the time until the network has reached stability or even longer than the disruption as such, the measure is of little use for disruption-management purposes. Since there is no strict approach towards establishing a practical value for the maximum transfer time (Stemer 2018), a specific value can be approached in multiple ways.

As the measure's practical relevance puts emphasis on ensuring it supports the network's transition to stable operations, one alternative may be assuming the maximum transfer time $t_{trans,max}$ equal to the length of the transition phase (see subsections 2.3.3). While the length of the transition phase depends on the type of railway network and the magnitude of the disruption, values around 30 minutes have been suggested for commuter railway lines in Chu and Oetting (2013). Another less restrictive alternative is to make it equivalent to the estimated disruption length t_{EDL} (see subsection 5.4). Ultimately, it can also be approached for the specific disruption and assigned according to the disrupted circumstances, as supported by the existing models discussed in subsection 2.3.2.

Solution approach:

The transferring of a train may be implemented on any train service on the side of a line with a surplus of vehicles. However, depending on a train's actual position, driving direction and the ability of the measure to be conducted with or without passengers, the original train service appointed to the train must be modified as follows:

- In case the train is driving away from the deviation location, the necessary turns must be scheduled at a technically feasible turning station. However, depending on the computational effort, implementing the measure on trains which require to change their driving direction to access the deviation route may be restricted. This is the case since there is a great likelihood that these trains would fail to fulfill the measure's boundaries of practical relevance.
- In case the train is driving towards the deviation location for the transfer, the necessary changes in the train services must be included, this entails the partial cancellation of the train service between the last station served before the threading-out, and the first station served after the threading-in back to its original route.
- In case the transfer cannot be conducted with passengers, the minimum time for emptying a train with or without a change in the driving direction before the deviation, as discussed in subsection 3.6.2, must be included in the stopping time of the train.

Aligned with the measure's prerequisites, it is possible to ascertain that the measure has a higher chance to ensure its positive impact if it is implemented on a train service that is the closest to the deviation point and does not require a change in its driving direction.

Combinability

The measure can be combined with other measures at the line-specific level that address the surplus or a lack of vehicle availability on an affected line. This is the case for an exchange of trains between lines (subsection 6.3.1), incorporate an external train (subsection 6.3.2) and removing and parking a train (subsection 6.3.3).

Ultimately, the implementation of the measure would lead to the partial cancellation of a train service throughout the portions of the train's route that are not reached due to the deviation.

Therefore, the partial cancellation of a train service is an inherent result of the implementation of the measure (see subsection 6.3.5).

Robustness

The transfer of a train between sides is an adept measure for equating the amount of traffic circulating in the railway network to its disrupted capacity by means of a spatial reallocation of its resources. Thus, the implementation of this measure may positively influence and support the capability of the network to reach stability within the disruption.

On the other hand, it is difficult and operationally infeasible to reverse or modify the measure once it is implemented, particularly, after the train has entered the deviation route. Consequently, the measure may impose a robust influence on the operating situation.

Furthermore, due to an increase of the stopping times at stations (to support the change in a train's driving direction, the time require to ensure it is empty of passengers and the likely existence of unscheduled stopping times for the threading-in of the train in the deviation route), the measure would also have a negative effect on the robustness of the network. In the same vane, since the train would most likely consume infrastructure capacity outside of the commuter railway network, the implementation of the measure also has a negative effect on the robustness of other railway networks.

Determining variables

While the measure permits to reallocate vehicle resources around the disrupted network and potentially support its transition to stable operations, the type of action and overall approach of the measure ought to still be appraised within the framework provided by the four determining variable categories discussed in subsection 6.2.2.

The measure is very likely to induce substantial spatiotemporal adjustments on the scheduled operations as the train must be deviated away from its original route. Therefore, the measure is prone to induce train delays, changes in routes and platform tracks. Furthermore, due to the spatiotemporal adjustments which are introduced by the transferring of a train, the measure is likely to induce direct occupancy, circulation and service conflicts. Finally, due to the deviation of trains through different routes, the measure would most certainly leave certain stations along the train's route without being serviced. As a result, the following determining variables may be considered:

- Train delay (Temporal)
- Changes of routes (Spatial)
- Changes of platform tracks (Spatial)
- Number of cancelled stops (Malus)
- Follow-up occupancy conflicts (Look-Ahead)
- Follow-up circulation conflicts (Look-Ahead)
- Follow-up service conflicts (Look-Ahead)

Dispatching time

As the implementation of the measure requires to establish potential deviation points for a transferred train, any deviation point that rests within the train's journey time interval equal to the time span between the system's deployment time $t_{0,TD}$ and the minimum communication time

$\min t_{Comm}$ may not be accessible. This restriction can be removed in correspondence to the actual implementation needs of the system.

6.3.5. Cancelling a Train Service – (CS)

Description of the type of action and possible impact

A train service can be either totally or partially cancelled. A total cancellation implies that the train service is cancelled along its entire route; on the other hand, a partial cancellation implies that only certain portions of its route are left unserved. The cancellation of a train service in the case of commuter railway networks has a direct impact on the serviceability of an affected line, as the cancelled train service widens the service interval at the affected stations (see subsection 3.6.2).

The (partial) cancellation of a train service can be conducted from two different perspectives. First, the systematic cancellation of a train service, as foreseen by the DRP operating concept. The DRP operating concept of a specific line and side (if applicable) may foresee the cancellation of train services from a line's original schedule (e.g. train services working as service interval reinforcement - see subsection 3.6.2) to equate the degraded capacity of the network with the number of trains circulating in the network. From this perspective, train services that are being cancelled would release their originally scheduled crew and vehicle resources, which may be reallocated to other train services. Second, the measure is implemented due to the immediate lack of crew or vehicle resources. For instance, in case of a complete blockage, the scheduled circulation plans of the trains can not be completely supported. Therefore, if no adjustment actions are taken, the train services on either side of the disruption would need to be systematically cancelled due to the lack of vehicle resources.

From the first perspective, the operating concept of the chosen DRP provides with a guideline to implement the measure on specific train services of a line and side (if applicable), as discussed in subsection 5.3. As the measure is applied to specific train services, it is vehicle-specific and able to support both the deployment of the DRP operating concept as well as the resolution of circulation conflicts.

From the second perspective, the measure may also be allocated to any of the train services of a line and side (if applicable) with a lack of vehicles. Therefore, the measure is also line-specific and capable of solving both vehicle availability and reachability conflicts.

Check for feasibility and quantification of the approach

Prerequisites for its implementation:

The cancellation of train services allows dealing with a lack of vehicle resources. Therefore, the measure can only be implemented in cases where a line and side (if applicable) either has a lack of vehicle resources or the DRP operating concept foresees the cancellation of train services from the original schedule of a given line and side (if applicable) (see subsection 5.3).

Solution approach:

Overall, the implementation of the measure differs between the total or the partial cancellation of a train service.

In case of a total cancellation, the implementation of the measure completely removes the affected train service from the schedule, releasing both its crew and vehicle or vehicle composition.

Furthermore, it must be indicated that if the disruption or the DRP operating concept divides a line into two different sides (e.g. during a complete blockage), the train services on each side may be handled independently from one another (see subsections 2.3.3 and 5.3). This is the case since both the schedule and the circulation plans are adjusted to match the actual operating situation and vehicle resources on each side of the divided line. Consequently, the cancellation of train services on either side amounts to a total cancellation.

On the other hand, a partial cancellation only removes specific portions of the scheduled route of a train service from the schedule. Therefore, in partial cancellation, both the crew and the vehicle or vehicle composition are maintained.

Combinability

The measure can be combined with other measures at the line-specific level that address the lack of vehicle resources of an affected line. This is the case of incorporating an external train (subsection 6.3.2) and the transferring a train (subsection 6.3.4). Ultimately, the implementation of the measure would lead to the widening of the affected line's service interval, which needs to be adeptly addressed by a transference of the passengers' waiting time (see subsection 6.3.13).

Robustness

As with the removal of a train from the network, the cancellation of train services aligned with the DRP operating concept supports the processes of equating the overall traffic circulating in the network with the disrupted capacity of the infrastructure. Therefore, the implementation of the measure from this perspective can be beneficial for the robustness of the network as it liberates infrastructure capacity making it available for other trains and supporting the transition of the system to stable operations.

Furthermore, once the measure has been implemented and announced to the passengers, it may be problematic to modify or withdraw. Finally, as it does not resolve the lack of resource availability, it can be considered merely a reactive measure that would most certainly transfer an additional burden to the users and the adjustment of the circulation plan of an affected line. Consequently, once implemented, the measure imposes a robust influence on the system.

Determining variables

While the measure permits to support the deployment of the DRP operating concept and deal with a lack of vehicle resources, the type of action and overall approach of the measure ought to still be appraised within the framework provided by the four determining variable categories discussed in subsection 6.2.2.

Both the partial or total cancellation of a train service produces no direct spatiotemporal effect on the railway operations. However, the implementation of the measure may directly produce circulation conflicts and service conflicts across the stations that have been affected. Additionally, the measure has a direct effect on the service quality by potentially removing a complete train service from the schedule or partially affecting specific stations along the cancelled portion of a train's route. Therefore, the following determining variables may be observed:

- Train Service Cancellation (Malus)
- Number of cancelled stops (Malus)
- Follow-up circulation conflicts (Look-Ahead)
- Follow-up service conflicts (Look-Ahead)

Dispatching time

The cancellation of a train service can be conducted without any further dispatching time limitation.

6.3.6. Early Turning a Train – (ETT)

Description of the type of action and possible impact

The measure entails turning a train at a technically feasible turning station before it reaches its end station and appointing to it a transition train service in the opposite direction. The train service appointed to the train after its turn may or may not be the same as foreseen in its circulation plan. This would depend on the phase of the disruption-management within which the measure is being implemented (see figure 2.5).

The measure is widely utilized in existing disruption-management models and particularly useful for managing trains that drive towards the disrupted section at the beginning of the disruption (see subsections 2.3.3 and 2.3.2). Regardless of the magnitude of the disruption (i.e. complete or partial blockage), the measure stands as an alternative to manage the number of trains that are able to reach stations within the critical area.

Moreover, the measure can also be utilized to address circulation conflicts between two specific train services. The measure solves circulation conflicts by allowing delayed trains to transition to the subsequent train service in their circulation plans before reaching their scheduled end stations. The early turn permits to either eliminate or reduce the delay that would potentially be transferred to the transition train service.

Furthermore, as the measure permits to turn trains before they reach their scheduled end station, an early turn may also be useful for dealing with occupational conflicts that take place at specific locations of the disrupted network (e.g. critical area). In addition, as the measure permits to appoint to a train any of the train services of its line in the opposite direction, it simultaneously supports the capability to resolve reachability conflicts.

Given that the measure permits to manage the transition between train services (in opposite driving directions), it is relevant for solving conflicts across both operational levels. Within the line-specific operational level, the measure supports the capability to use trains driving towards the affected area to solve the reachability conflicts of a line. On the other hand, within vehicle-specific conflicts, it stands as an adept alternative to address occupancy conflicts that take place on infrastructural elements with limited capacity (e.g. critical area) and also circulation conflicts between train services.

Check for feasibility and quantification of the approach

Prerequisites for its implementation:

Regardless of the conflict type being addressed, the utilization of an early turn requires to consider technical and operational prerequisites.

Technically, the measure requires to be implemented at a turning station in which there are platform track groups that permit a train to change its driving direction and additionally access the necessary links to support the scheduled route after its turn (i.e. technically feasible turning stations).

Operationally, the implementation of the measure requires the appointment of an available train service of the same line (or corresponding line) in the opposite direction and the acknowledgement of the existence of a minimum turning time, as detailed in subsection 3.6.2. Furthermore, the measure also requires to partially cancel portions of the routes of at least one of the train services involved in the early turn. Therefore, the measure imposes a burden on passengers' welfare throughout the affected stations, which makes it difficult to justify its implementation outside of disrupted operations.

Since the measure can be utilized to address different conflict types across both operational levels, namely, reachability, occupancy and circulation conflicts, further requirements become relevant.

The implementation of the measure in the line-specific level requires establishing a list of potential transition train services that are not being serviced (e.g. train services identified as reachability conflicts). Particularly, during a complete blockage or when the DRP operating concept foresees the separation of a line into two different sides (see subsection 5.3), the independent handling of the train services on either side of the disruption must be supported. Therefore, special train numbers must be assigned to the transition train services on the side of the disrupted network that already exists on the opposite side (see subsection 5.3.2 and 3.6.2).

At the vehicle-specific operational level, the implementation of the measure entails different requirements between circulation and occupancy conflicts. To solve circulation conflicts, the implementation of the measure is restricted to handle conflicting circulations where a transfer between train services involves a change of a train's driving direction (i.e. turn). To solve occupancy conflicts, the implementation of the measure is restricted to handle occupancy conflicts across locations of the network where infrastructure capacity is limited, and the operating situation justifies one of the conflict partners to change its driving direction (e.g. critical area near the disrupted section – see subsection 3.6.2).

Solution approach:

The implementation of the measure starts by establishing a train to which the measure can be appointed. Depending on the operational level and the type of conflict being addressed, the measure may be more purposefully implemented on trains that find themselves within certain operating circumstances. At the line-specific level and to solve reachability conflicts, the measure may be implemented on any train driving towards the disrupted section. At the vehicle-specific level and to solve circulation conflicts that involve a change of driving direction, the measure is usually implemented on trains driving towards the station where the conflicting circulation between train services has been identified. To address occupancy conflicts, the measure may be implemented on any of the trains involved in the occupancy conflict and that have the possibility to access a technically feasible turning station before reaching the infrastructural element where the occupancy conflict has taken place.

Subsequently, once a specific train has been established, a technically feasible turning station and a platform track where the early turn is to be executed must also be established. An early turn can be conducted at any technically feasible turning station along a train service's route with the sole exception of its end station. Technically feasible turning stations outside a train service's route may also be taken into consideration (as required by the actual operating situation or the DRP operating concept). Nonetheless, in order to reduce as much as possible, the impact on railway users, the technically feasible turning station selected to execute the early turn should be located the closest to the identified conflict.

At the beginning of the disruption-management and depending on the magnitude of the disruption (i.e. complete or partial blockage), the implementation of the measure would need to recognize different end stations for the train services driving towards the disrupted section.

- During a partial blockage, trains are theoretically still able to reach their scheduled end stations.
- During a complete blockage, trains are, at most, able to reach the LtFTS on their respective sides. However, depending on the DRP operating concept certain trains may still be able to reach their end station if a deviation is being foreseen.

Once a technically feasible turning station and a platform track have been established, a transition train service (train service in the opposite direction) must be selected so that it can be appointed to the train after it changes its driving direction. The train may have appointed as a transition train service: the train service originally foresaw in its circulation plan, a different train service that is included in its line's DRP operating concept or any of the train services identified as reachability conflicts for the respective line and side. However, if the train is appointed a different train service as the one originally foresaw in its original circulation plan, the train's circulation plan must be adjusted accordingly. The circulation plan corresponding to the newly appointed transition train service aligned with the DRP operating concept constitutes the basis of the affected train's new circulation plan.

While the implementation of the measure prevents a train to reach its end station and the chosen turning station is most likely not aligned with the beginning station of its transition train service, the portions of the routes which are not being serviced due to the implementation of an early turn must be removed from the schedule of both of the involved train services.

Furthermore, once the transition train service and the turning station have been selected, the earliest projected departure time of the train from the turning station after the change in the driving direction must be established. The earliest departure must support the existence of a minimum turning time $min t_{Turn}$, which depends on the number of train drivers within the train, as discussed in subsection 2.3.3. If the selected train service in the opposite direction and its scheduled departure from the turning station lead to a negative turn the minimum turning time $min t_{Turn}$ must still be respected, as detailed in subsection 3.6.2. In case of a positive turn, the train must wait in the platform track after its change in driving direction until the departure time detailed in the schedule of the transition train service (see subsection 3.6.2).

Combinability

The measure covers overall three conflict types across the two operational levels and can be respectively combined with further measures.

At the vehicle-specific level for both occupancy and circulation conflicts, an early turn can be combined with further measures that permit to accommodate a train's early turn in the actual operating situation of the chosen turning station (e.g. rerouting a train).

At the line-specific level, the implementation of the measure can be purposefully combined with other measures that permit to address reachability conflicts. This is the case for exchanging trains between lines (see subsection 6.3.1), incorporating an external train (see subsection 6.3.2), and transferring of a train between sides (see subsection 6.3.4).

Ultimately, since the implementation of the measure would inherently lead to the partial cancellation of portions of the scheduled route of at least one the train services involved in the measure, the partial cancellation of train services is an inherent outcome of the implementation of the measure (see subsection 6.3.5).

Robustness

The implementation of the measure has both a positive and negative influence on the robustness of the system. The positive influences on the robustness of the network (e.g. reducing delay, supporting handling the train queue across the critical area) must be weighed vis-à-vis the negative influences induced by the measure.

On the one hand, the early turning of a train facilitates managing the overall number of trains reaching the critical area. The ability to manage the number of trains reaching the critical area is instrumental in addressing the queuing of trains before the last technically feasible turning station (see subsection 2.3.3).

Additionally, as discussed above, the implementation of the measure at the vehicle-specific level may also permit to curb delay. Thus, by implementing an early turn, the transitioning of the network towards stable operations may be enhanced and the implementation of the measure may have a positive influence on the robustness of the network.

On the other hand, due to the required change in driving direction, the implementation of the measure leads to an increase in the occupancy time of the affected train at the platform track in the chosen turning station. Furthermore, while it allows traffic circulating in the system to be redirected, it does so at the expense of passengers' welfare. The negative influence of an early turn on passengers' welfare differs between the locations in the network where it is implemented. For example, when the measure is implemented near the end or beginning stations of the involved train services, the portions of the routes to be cancelled are minimized. Nevertheless, the implementation of the measure affects passengers across both of the involved train services. Therefore, the implementation of an early turn also has a negative influence on the robustness of the railway network.

Determining variables

The type of action and overall approach of the measure must still be appraised within the framework provided by the four determining variable categories discussed in subsection 6.2.2.

The measure introduces spatiotemporal adjustments on the scheduled operations as an affected train must be turned before it reaches its originally scheduled end station. Therefore, the measure is prone to induce, train delays, changes in the scheduled turning stations, changes in routes and changes in platform tracks. Due to the spatiotemporal adjustments, the measure is also likely to induce direct occupancy, circulation and service conflicts. Moreover, since the measure inherently requires that portions of the route of at least one of the involved train services are cancelled, the measure would most certainly leave certain stations along the train's route without being serviced. Furthermore, since the affected train may require a total adjustment of its circulation plan within an uncertain duration of the disruption, it very likely that an end-of-day imbalance is induced.

As a result, the following determining variables may be considered:

- Train delay (Temporal)
- Changes of platform tracks (Spatial)

- Changes of routes (Spatial)
- Changes of scheduled turning stations (Spatial)
- Follow-up occupancy conflicts (Look-Ahead)
- Follow-up circulation conflicts (Look-Ahead)
- Follow-up service conflicts (Look-Ahead)
- End-of-day imbalance (Malus)
- Train Service Cancellation (Malus)
- Number of cancelled stops (Malus)

Dispatching time

The early turning of a train can be allocated to any of the train services in the network, yet the measure can only be implemented at a technically feasible turning station. Any turning station that rests in the journey time interval between the system's deployment time $t_{0,TD}$ and the minimum communication time $\min t_{Comm}$ may not be available. This restriction can be removed in correspondence to the actual implementation needs of the system.

6.3.7. (De)Coupling a Train – (DCT) & (CT)

Description of the type of action and possible impact

The coupling of a train merges vehicles or existing vehicle compositions to constitute a new vehicle composition that is appointed to a specific train service. On the contrary, the decoupling separates an existing vehicle composition, resulting in different vehicles or vehicle compositions to be appointed to more than one train service.

Both of these measures permit dealing with vehicle resource availability. The coupling of trains would inherently reduce the number of trains circulating in the network. On the other hand, the decoupling of trains would provide with supplementary vehicle resources.

Each of the measures permits to address the reallocation of available vehicle resources with respect to the DRP operating concept of each of the affected lines and sides (if applicable) (see subsection 5.3 and 5.4). While the coupling of trains would inherently reduce the number of surplus vehicles, the decoupling would weaken existing vehicle composition and establish new trains. Since the measures can be allocated to any of the trains circulating in the network servicing a line with either a surplus or a lack of vehicles, both measures stay within the line-specific operational level and capable of solving vehicle availability conflicts. However, in the case of the decoupling of trains, the measure is also capable of solving reachability conflicts (see subsection 3.6.2).

Check for feasibility and quantification of the approach

Prerequisites for its implementation:

Both of these measures are generally restricted to networks that already have built within their scheduled operations the coupling and decoupling of trains as scheduled transitions between train services (see subsection 3.6.2). The use of these measures during normal operations provides with a robust framework for their implementation within disrupted circumstances. This is particularly the case in regard to the availability of crew members (i.e. drives) on board of the different trains and the management of vehicles prior, during and after the implementation of the measures. Consequently, it becomes essential to ensure that the limitations for the implementation of these

measures between different railway networks can be supported by the dynamic DRP deployment system, allowing the user to enable or restrict their utilization as elemental conflict solution alternatives.

In order to have a closer examination of further prerequisites, each measure is discussed individually.

- The coupling trains can be implemented in cases where, as a product of the disruption and the stipulated changes introduced by the DRP operating concept of a line, there is a surplus of trains circulating in the network. Moreover, the coupling of the trains is also restricted in its technical sense, as it can only be conducted if the involved vehicles can be coupled with each other. This not only entails the ability to physically couple the vehicles but also considering the resulting length of the coupled trains. The resulting vehicle composition should not be longer than the platform with the shortest length along its route (see subsection 3.6.2).

Furthermore, the same constraints regarding lines and corresponding lines discussed in subsection 6.3.1 are also valid for establishing which trains may be coupled with each other. The implementation of the measure also requires to establish a station in which trains are to be coupled with each other. Additionally, the measure also requires to establish the portions of the routes of at least one of the involved train services that need to be partially cancelled due to the coupling.

- The decoupling of trains can be implemented in cases where, as a product of the disruption and the stipulated changes introduced by the DRP operating concept of a line, the number of trains needed to service the operating concept is less than the number of trains in circulation.

Additionally, the measure can only be implemented in case there is the necessary number of drivers, either already in the train (as discussed in subsection 5.4.2) or at the station where the decoupling is being implemented.

At last, since the measure is applied during disrupted operations, the scheduled characteristics of the vehicle compositions appointed to the train services (e.g. resulting train length) can be ignored. This permits to utilized vehicle compositions with fewer vehicles than originally scheduled (see subsection 3.6.2).

Solution approach:

To have a clear overview of the solution approach, each measure is discussed individually.

- The implementation of the coupling begins with the identification of the two trains, which are to be coupled with each other. Identifying potential trains that can be coupled entails considering the above-described implementation requirements.

Once the vehicles have been identified, a location in the network where to conduct the coupling of the trains must be established. The chosen location must be a common node among the scheduled routes of both trains involved in the measure (i.e. usually a station). However, to ensure that the number of trains driving towards the disrupted section is minimized, the coupling of trains should be conducted in stations prior to stations in the critical area.

Furthermore, according to the original schedule, the arriving sequence of the involved trains and their necessary waiting times t_w can be established. After the arrival of the last train at

the station a minimum transition time $\min t_{Trans}$ between train services, as discussed in subsection 3.6.2, must be contemplated for guaranteeing the coupling of the trains.

The characteristics of the resulting vehicle composition are updated together with the train service and circulation plan. There are two possibilities for assigning a new train service and a circulation plan to the resulting train. One of the original train services and circulation plan of the trains involved in the coupling is maintained. A different train service and circulation plan stipulated in the DRP operating concept of the line and side (if applicable) is assigned to the resulting vehicle composition.

Finally, depending on the train service that is appointed to the resulting vehicle composition, the routes of the original train services that are no longer serviced must be partially cancelled.

- The implementation of the decoupling starts with an identification of possible trains, abiding by the conditions discussed in the requirements.

Once a train is identified, a location in the network where the measure is to be implemented, (commonly a station) must be established. As in the case of the coupling, to ensure that the number of trains driving towards the disrupted section is minimized, the decoupling of trains should be conducted once the train has left the stations in the critical area.

At the chosen location, the characteristics of the resulting vehicle compositions are updated, and each of the trains is allocated a new train service and circulation plan. The potentials for the appointment of the train services and circulation plans are the same as the ones discussed for the coupling case.

To support the decoupling of the trains, the minimum transition time $\min t_{Trans}$ must be contemplated. Moreover, for the systematic existing of the resulting trains from the location where the decoupling has taken place (depending on the driving direction of the trains), the minimum headway time $t_{min HT}$ must also be respected.

Combinability

The coupling and the decoupling of trains addresses respectively the lack or surplus of vehicle resources for a specific line or line's side (if applicable). Therefore, the measures can be combined with further measures at the same level that deal with similar conflicts induced by the disruption.

The decoupling (DCT) of a train may be combined with the exchanging of trains between lines (see subsection 6.3.1), incorporating an external train (see subsection 6.3.2) and transferring a train (see subsection 6.3.4).

The coupling (CT) of trains can be combined with the exchanging of trains between lines (see subsection 6.3.1), removing and parking a train (see subsection 6.3.3), transferring a train (see subsection 6.3.4) and the early turning a train (see subsection 6.3.4). The implementation of the coupling would inherently lead to the partial cancellation of portions of the route of at least one of the train services involved in the measure. Therefore, the partial cancellation of train services is an inherent consequence of the implementation of the coupling of trains (see subsection 6.3.5).

Robustness

The coupling of a train is a measure that supports equating the amount of traffic circulating in the railway network with its disrupted capacity. However, instead of removing the vehicle or vehicle composition from the network, the measure permits to maintain the vehicles in the system, expanding the passenger transporting capabilities of the train service product of the implementation of the measure. The decoupling of trains follows a similar approach as it permits

to uphold the serviceability of the line during a disruption by taking advantage of existing vehicle resources.

Since both measures maintain the vehicles circulating in the network, they can be modified with much less effort as other available alternatives, for example, removing and parking of a train or incorporating an external train. Such quality enhances the flexibility with which vehicle availability conflicts may be handled.

Nevertheless, due to the need to support the minimum transition time at the coupling and decoupling stations, the implementation of both measures induces an increase in the occupancy time. Furthermore, in the case of coupling, the resulting longer train lengths would most certainly induce higher occupancy times throughout the infrastructural elements along the route of the resulting vehicle composition. Therefore, both would also induce a negative influence on the robustness of the network.

Determining variables

While the measures permit to reallocate vehicle resources around the disrupted network, the type of action and overall approach of each measure ought to still be appraised within the framework provided by the four determining variable categories discussed in subsection 6.2.2.

The measures are very likely to induce substantial spatiotemporal adjustments on the scheduled operations as the involved trains must be coupled or decoupled at specific stations. Therefore, the implementation of the measures is prone to induce train delays, changes in routes and platform tracks. Furthermore, due to the spatiotemporal adjustments which are introduced by both measures, it is likely that they induce direct occupancy, circulation and service conflicts. Since the trains affected by the measures may require a total adjustment of their circulation plan within an uncertain duration of the disruption, it is very likely that end-of-day imbalances are induced. As a result, the following determining variables may be considered:

- Train delay (Temporal)
- Changes of platform tracks (Spatial)
- Changes of routes (Spatial)
- Train Service Cancellation (Malus)
- Number of cancelled stops (Malus)
- End-of-day imbalance (Malus)
- Follow-up occupancy conflicts (Look-Ahead)
- Follow-up circulation conflicts (Look-Ahead)
- Follow-up service conflicts (Look-Ahead)

Dispatching time

Since the measure requires to establish coupling and decoupling stations, any station that rests in the involved trains' journey time interval between the system's deployment time $t_{0,TD}$ and the minimum communication time $\min t_{Comm}$ may not be available. This restriction can be removed in correspondence to the actual implementation needs of the system.

6.3.8. Shifting a Train in Time – (STT)

Description of the type of action and possible impact

Through a shift in time, the overlapping occupancy times (i.e. occupancy conflict) of two or more trains at a certain infrastructural element can be addressed. The measure shifts a train in time by introducing a waiting time t_w so that the minimum headway time $t_{min\ HT}$ is respected, hence, eliminating the overlapping of the occupancy times. The measure can also be utilized to solve circulation conflicts so that the arrival of a delayed train to the station where the transition is scheduled plus the minimum transition time is compatible with the departure time of the transition train service from the station.

Considering that the main focus of the measure is the introduction of a waiting time in the schedule of specific trains, the measure is implemented at the vehicle-specific operational level and permits to solve occupancy and circulation conflicts (see subsection 3.6.2).

Check for feasibility and quantification of the approach

Prerequisites for its implementation:

The measure can be implemented on any train circulating in the network involved in an identified occupancy or circulation conflict.

The implementation of the measure requires establishing which train or trains involved in the conflict are to be shifted in time (i.e. affected by the measure). Furthermore, the measure also requires to establish a location in the network (i.e. platform track, end of a link) where the affected train or trains may have the waiting time introduced in their schedules. At last, the length of the waiting time introduced in the schedule of the affected train or trains must be established depending on the type of conflict being addressed, namely, occupancy or circulation conflict.

Solution approach:

To have a clear overview of the solution approach, the implementation of the measure to solve each of the addressed conflict types is discussed individually.

For occupancy conflicts, the implementation of the measure first establishes a specific train or trains to be affected by the measure amongst all the trains involved in the conflict. As in discussed in Oetting et al. (2013), the utilization of a microscopic infrastructure modelling technique permits to classify the identified occupancy conflict with enough detail so that the specific train or trains to be affected by the measure can be established (see also Neuber 2017). However, in cases where the utilized modelling technique does not permit a detailed classification of the occupancy conflict, further heuristic rule-based approaches are also available for the exploration of solution alternatives that involve shifting different conflict partners in time (see Oetting et al. 2011). Subsequently, the infrastructural elements, where the measure would introduce the necessary waiting time to the affected train(s), must be established. The measure can either extend an existing scheduled stop or introduce a new stopping location for the affected train(s) along its route. However, the principles discussed above for choosing the affected train(s) are also applicable for establishing the infrastructural elements, namely, relying on the classification of the conflicts or the use of further rule-based approaches for the exploration of different solution alternatives. Finally, having established both the train(s) to be affected by the measure and the infrastructural elements, the length of the waiting time t_w is established. The length of the waiting

time for each of the affected trains is established so that the minimum headway times $t_{min HT}$ across all trains involved in the occupancy conflict are satisfied.

For circulation conflicts, the establishment of both the specific train service amidst all train services involved in the circulation conflict and the infrastructural element where to introduce the waiting time is a much simpler task than for occupancy conflicts. This is the case since to solve circulation conflicts, the implementation of the measure is mostly relevant if applied on the transition train service (see subsection 3.7.2). Shifting any other train service in time would most likely worsen the circulation conflict, as the sole reason to introduce the waiting time is an already existing delay in one of the trains involved in the scheduled circulation. For the same reason, the infrastructural element where the measure foresees the introduction of the waiting time is, in general, located at the station where the conflicting circulation between train services takes place. Finally, the length of the waiting time t_w introduced in the schedule of the transition train service is established so that its departure time from the station after the transition has taken place supports the minimum transition time $min t_{Trans}$ (i.e. coupling, decoupling or turn – see subsection 3.6.2).

Combinability

The measure can be combined with further alternatives at the vehicle-specific operational level that permit to address occupancy or circulation conflicts. Therefore, the measure can be combined with an early turn, as discussed in subsection 6.3.6.

Robustness

Shifting a train in time increases the occupancy time of the affected train or trains at the infrastructural element(s) where the waiting time has been introduced in their schedules. By increasing the occupancy time, the probability of generating occupancy and circulation conflicts on further trains is also extended. Thus, the measure would have a negative influence on the robustness of the network.

Nonetheless, once implemented and if there is enough time to communicate the necessary changes to the relevant staff members, the measure can be easily readjusted and even withdrawn so that it is always aligned with the actual operating situation of the network. As a result, the implementation of the measure in itself is relatively flexible.

Determining variables

The type of action and overall approach of the measure must still be appraised within the framework provided by the four determining variable categories discussed in subsection 6.2.2.

The measure introduces temporal adjustments on the scheduled operations of the affected train(s); thus, the measure would induce train delays. Furthermore, due to the temporal adjustments introduced by the measure it is also likely that it may generate occupancy and circulation conflicts on further trains. As a result, the following determining variables are considered:

- Train delay (Temporal)
- Follow-up occupancy conflicts (Look-Ahead)
- Follow-up circulation conflicts (Look-Ahead)

Dispatching time

The shifting of a train in time can be conducted without any further limitation.

6.3.9. Bending a Train – (BT)

Description of the type of action and possible impact

As discussed in subsection 3.6.2, the bending of a train entails an adjustment of the train's speed within a portion of its route in order to make its movement compatible with the actual operating situation of the network.

When compared to the shifting of a train in time (see subsection 6.3.8), the measure provides a much more robust approach to address both occupancy and circulation conflicts. Instead of introducing a waiting time on the conflict partners, the measure modifies their speed, affecting their journey time to make their movement compatible with the operational constraints (e.g. minimum headway times) and potentially support a much efficient energy consumption.

The term "bend" refers to the adjustment of a trains' speed, which in turn modifies its projected movement through the infrastructure as represented in the traffic diagram. The extension of a train's journey time is understood as a positive bend, on the other hand, a reduction of a train's journey time is referred to as a negative bend (see subsection 3.6.2).

The measure is applied to solve conflicts between trains circulating in the infrastructure. Therefore, as for the shifting of a train in time, the measure is implemented at the vehicle-specific level and utilized to solve occupancy and circulation conflicts.

Check for feasibility and quantification of the approach

Prerequisites for its implementation:

The measure can be implemented on any train circulating in the network involved in an identified occupancy or circulation conflict.

To implement the measure, it is necessary to consider: the operational circumstances in which the conflict has taken place, the infrastructural modelling quality being utilized, the trains involved in the conflict, the trains to be affected by the measure and the trains' driving dynamic characteristics.

Additionally, for each of the affected trains, a bending factor, which has as its 100% the shortest journey time for the model train within the observed portion of its route, must be established. The establishment of the bending factor depends among other things, on the type of conflict being addressed, namely, occupancy or circulation conflict.

Solution approach:

To have a clear overview of the solution approach, the implementation of the measure to solve each of the addressed conflict types is discussed individually.

For occupancy conflicts, the measure starts by establishing which of the trains involved in the conflict would be affected by the measure. In this regard, aspects like: the time required to resolve the occupancy conflict for each individual train involved in the conflict, and the distance between the trains and the location in the infrastructure where the occupancy conflict has been identified, are critical for the implementation of the measure. Therefore, for each of the involved trains, the time that can be gained by readjusting their driving speed throughout the available portion of their routes (i.e. bending) must be carefully managed in such a way that the measure delivers an optimal solution, which must also support an energy consumption perspective. Additionally, the necessary adjustments in the speed must abide with the technical capabilities of the affected trains

(particularly relevant for negative bending). The establishment of the specific trains to which the measure is to be implemented and the bending factor to solve the identified conflicts can be ascertained through the approach introduced in Oetting et al. (2013). The approach is implemented in two steps and relies on the utilization of a microscopic infrastructural model.

1. The shortening of the journey time of the first train involved in the conflict is examined; this also implies identifying the earliest and latest locations in the infrastructure for the implementation of the negative bend in correspondence to the conflicting section. If the overlapping has been solved through the shortening of the journey time of the first train, the second step is not necessary.
2. The extension of the journey time of the subsequent trains is examined and, as in the previous step, the earliest and latest locations in which the bending of each train is to take place are identified. Furthermore, the necessary bending factor at each of the limiting locations is calculated for each of the trains. Finally, the subdivision of the bending sections across all involved trains and their compatibility is checked, until the best combination is identified.

Since the dynamic DRP deployment system relies on the enhanced macroscopic modelling of the infrastructure discussed in subsection 5.1, the approach introduced by Oetting et al. (2013) can not be immediately supported. Therefore, if the measure is to be implemented, a different approach compatible with the utilized modelling technique should be established.

For circulation conflicts, currently, there is no existing approach that supports the implementation of the measure. The measure may be implemented so that a negative bend may minimize or completely resolve the circulation conflict. Therefore, the purposeful implementation of the measure would focus on a potentially delayed train driving towards the station where the circulation conflict has been identified. Nonetheless, an approach aligned with the infrastructure modelling technique that permits to establish the actual bending factor must still be introduced.

Combinability

The bending of a train can be combined with further measures at the vehicle-specific operational level available to solve both occupancy and circulation conflicts. Thus, the measure can be combined with early turns (see subsection 6.3.6) and the shifting of a train in time (see subsection 6.3.9).

Robustness

Since the measure focuses on extending or shortening a trains' journey time, there is an increased likelihood that the bending of a train would induce occupancy or circulation conflicts with other trains. Consequently, the measure may have a negative influence on the robustness of the network.

On the other hand, just as the shifting of a train in time, if there is enough time to communicate the necessary changes to the relevant staff members, the measure can be easily readjusted and even withdrawn so that it is always aligned with the actual operating situation of the network. Furthermore, by adjusting the speed of conflicting trains, the measure supports a much robust management of the capacity consumption of the infrastructural elements around the network.

Determining variables

The type of action and overall approach of the measure must still be appraised within the framework provided by the four determining variable categories discussed in subsection 6.2.2.

The bending of a train introduces temporal adjustments on the scheduled operations as the affected train(s) have their journey times modified within a given stretch of their routes. Accordingly, the measure is prone to induce train delays and further occupancy as well as circulation conflicts. As discussed in Oetting et al. (2013), given that the main emphasis of the measure entails the adjustment of a train's speed, it is also relevant to consider the train's relative energy consumption. The relative energy consumption of a train can be evaluated in correspondence to the utilization of a standard measure like the shifting of a train in time. As a result, the following determining variables are considered:

- Train delay (Temporal)
- Relative energy consumption (Malus)
- Follow-up occupancy conflicts (Look-Ahead)
- Follow-up circulation conflicts (Look-Ahead)

Dispatching time

The bending of a train can be conducted without any further limitation.

6.3.10. Cancelling a Train Stop – (CTS)

Description of the type of action and possible impact

The cancelling of a train stop is a measure that contemplates the elimination of one or more scheduled stops of a train along its route in order to reduce its journey time (Stelzer 2016, p.111). The measure permits to remove any of the scheduled stops of a train regardless of their purpose (i.e. passenger exchange or operational).

Considering that the main focus of the measure is the reduction of a specific train's journey time, the implementation of the measure is relevant within the vehicle-specific operational level. Furthermore, by affecting the journey time of a train, the cancelling of a train stop allows solving occupancy and circulation conflicts.

Check for feasibility and quantification of the approach

Prerequisites for its implementation:

The measure can be implemented on any train circulating in the network involved in circulation or occupancy conflicts.

The implementation of the measure requires establishing which trains involved in the conflict are to be affected by the measure. Furthermore, the measure requires that the affected trains have at least one scheduled stop between their actual location and the infrastructural element where the occupancy or circulation conflict has been identified. Additionally, the measure also requires to establish the number of stops that should be removed from the affected train's schedule in order to solve or address the identified conflict.

Solution approach:

To have a clear overview of the solution approach, the implementation of the measure to solve each of the addressed conflict types is discussed individually.

For occupancy conflicts, selecting both the trains being affected by the measure and the number of stops to be removed from their schedules can be established through rule-based heuristic approaches similar to those utilized for the shifting of a train in time (see subsection 6.3.8 and Oetting et al. 2011). Once the specific trains and stop(s) have been established, the respective stopping times t_{stop} are removed and the departure times from the affected nodes updated in each of the affected train's schedules. If a selected stop was at a station where passenger exchange needed to take place, the cancellation of the affected train service at the station must be taken into consideration.

For circulation conflicts, as with the bending of a train in time, the purposeful implementation of the measure should focus on the train, which drives towards the station where the circulation conflict has been identified. The measure is implemented so that the reduction of the journey time obtained by the removal of the stopping times either reduces or completely resolves the circulation conflict. As with occupancy conflicts, once the stops along the affected train's route have been selected, the stopping times t_{stop} from the train's schedule are removed, and the departure times from the affected nodes updated.

Combinability

The measure can be combined with other measures at the vehicle-specific operational level, capable of solving occupancy or circulation conflicts. More specifically, it can be combined with the early turning of a train (see subsection 6.3.6), the shifting of a train in time (see subsection 6.3.8) and the bending of a train (see subsection 6.3.9). However, when applied to the same train, the combination of the measure with a shift of a train in time is less purposeful as it would undermine its own purpose.

Ultimately, the implementation would inherently lead to the partial cancellation of the train service at the stations that have been directly affected by the measures. Therefore, the partial cancellation of train services is an inherent consequence of the implementation of the measure (see subsection 6.3.5).

Robustness

By removing a train stop, the journey time of a train and the occupancy times of the infrastructural elements along the train's route are also reduced. Thus, the cancelling of a train's stop may have a positive influence on the robustness of the disrupted network. On the other hand, the reduction of a train's journey time may also cause occupancy conflicts with further trains, as the train would have its journey time modified.

Additionally, depending on the length of the stopping time that is being removed, the measure may or may not be able to solve the identified conflict by itself. Therefore, it is highly likely that the measure would need to be combined with other elemental conflict solution measures to solve occurring conflicts.

Furthermore, if the cancelled stop is at a station in which the exchange of passengers was foreseen, the measure would affect the welfare of both passengers in the train and passengers waiting at the cancelled station(s). Therefore, since the measure affects two different groups of passengers (i.e. in the train and at the stop), its influence on the passengers' welfare may be qualified at least as extensive as for other measures that impose a negative influence on passenger's welfare (e.g. ETT - see subsection 6.3.6).

Moreover, if there is enough time to communicate the necessary changes, it is possible to withdraw or even modify the cancellation of train stops. However, since the information must be communicated to passengers, the modifications are much more restrictive when compared to other similar measures (e.g. shifting a train in time). Therefore, the implementation measure is in itself robust.

Determining variables

The type of action and overall approach of the measure must still be appraised within the framework provided by the four determining variable categories discussed in subsection 6.2.2.

The cancelling of a train stop introduces temporal adjustments on the scheduled operations as the affected train(s) have their journey times modified within a given stretch of their routes. Accordingly, the measure is prone to induce further occupancy as well as circulation conflicts. Furthermore, given that the measure can remove stops where passenger exchange was foreseen, the measure may also induce service conflicts. As a result, the following determining variables are considered:

- Number of cancelled stops (Malus)
- Follow-up occupancy conflicts (Look-Ahead)
- Follow-up circulation conflicts (Look-Ahead)
- Follow-up service conflicts (Look-Ahead)

Dispatching time

The cancellation of stops can be allocated to any train circulating in the network. However, the scheduled stopping locations of the train service that are within the train's journey time interval equal to the time span between the system's deployment time $t_{0,TD}$ and the minimum communication time $\min t_{comm}$ may not be cancelled. This restriction can be removed in correspondence to the actual implementation needs of the system.

6.3.11. Rerouting a Train – (RRT)

Description of the type of action and possible impact

The rerouting of a train observes the modification of a train's route throughout the nodes and links detailed in its schedule. The modification involves adjusting the scheduled route of a train by introducing a different combination of infrastructural elements (e.g. platform tracks, switches, tracks), while simultaneously allowing the affected train to reach all the nodes foresaw in its schedule. The rerouting of a train allows the affected train to reduce its delay, deal with limited infrastructure availability or avoid occupancy conflicts.

The rerouting of a train is implemented on specific trains; thus, the measure has particular relevance at the vehicle-specific operational level. More explicitly, the measure provides an approach capable of solving occupancy, infrastructure availability or circulation conflicts.

Check for feasibility and quantification of the approach

Prerequisites for its implementation:

The measure can be implemented on any train circulating in the network involved in circulation, infrastructure availability or occupancy conflicts.

The implementation of the measure requires first establishing which of the train or trains involved in the conflict may be affected by the measure. Trains can be affected by the measure if they can be routed along the infrastructure in such a way that it is purposeful to solve the handled conflict and still reach all the stations detailed in their schedule.

Once a specific train or trains have been established, different routing alternatives through nodes and links must also be established. For selecting a possible routing alternative, the conflict location and a possible search area must be identified. The potential routing alternatives for the affected train or trains must contribute to the resolution of the conflict while abiding with both technical and operational requirements. The technical requirements consist of acknowledging the compatibility between the investigated infrastructural elements and the technical characteristics of the train (e.g. gauge, existence of an overhead line). On the other hand, the operational requirements focus on ensuring the alternative routes support the ability of the affected train to reach all the nodes in its schedule.

Solution approach:

To have a clear overview of the solution approach, the implementation of the measure to solve each of the addressed conflict types is discussed individually.

For occupancy and infrastructure availability conflicts, selecting both the trains being affected by the measure and the routing alternatives for each of the affected trains can be established through rule-based heuristic approaches similar to those utilized for the shifting of a train in time (see subsection 6.3.8 and Oetting et al. 2011). For example, in Oetting et al. (2011), the search area is normally reduced to the elements adjacent to the conflict, but it can be expanded to additional neighbouring elements if no plausible route has been identified. Once the affected trains and the alternative routes have been identified, the portions of the original route affected by the alternative routes are respectively adjusted in the schedules of each of the affected trains. This entails adjusting the utilized platform tracks, and adequately updating the scheduled arrival and departure throughout the nodes according to the foresaw adjustments.

For circulation conflicts, as with the bending of a train in time and the cancellation of a stop, the purposeful implementation of the measure should focus on the train, which drives towards the station where the circulation conflict has been identified. The measure is implemented so that the train is able to reach the platform track where the transition between train services has been scheduled through an alternative route. It is also possible to even change the platform track where the conflicting transition between train services has been originally scheduled. However, changing the platform track where the transition between train services is being conducted entails considering the technical and operational requirements of the transition train service in the exploration of routing alternatives. As with occupancy conflicts, once the routing alternatives have been established, the portions of the route in the affected train's schedule are modified. This also entails adequately updating the scheduled arrival and departure throughout the nodes according to the foresaw adjustments. If there is a change in the platform track, the adjustments must also be included in the schedule of the transition train service.

Combinability

The rerouting of a train can be combined with other measures at the vehicle-specific operational level capable of solving occupancy, infrastructure availability or circulation conflicts. More specifically, it can be combined with the early turning of a train (see subsection 6.3.6), the shifting

of a train in time (see subsection 6.3.8) and the bending of a train (see subsection 6.3.9) and the cancelling of a train stop (see subsection 6.3.10).

Robustness

Allowing to reroute conflicting trains increases the overall handling opportunities to solve the identified conflicts. However, the utilization of unscheduled infrastructural elements to support the movement of a conflicting train would unavoidably increase in the probability of engendering additional occupancy and circulation conflicts. Therefore, the measure would induce a negative influence on the robustness of the network.

Furthermore, if the rerouting foresees changes in the scheduled platform track, this would have an effect on passengers' welfare. After changing the platform track, the passengers at the stations must be adequately communicated so that they can also change the platform track. Thus, a change in the platform track is particularly detrimental to the welfare of passengers if the changes are not communicated to passengers with the necessary time for them to change the platform. Nonetheless, when compared to measures that induce the cancellation of a train service (e.g. ETT – see subsection 6.3.6), the rerouting of a train does not induce such a strong influence on the welfare of passengers.

Moreover, the measure can be withdrawn and even adjusted to fit the changes in the operating situation; however, these adjustments are also limited by the capability to commute them to the involved parties. Therefore, the measure is in itself moderately robust.

Determining variables

The type of action and overall approach of the measure must still be appraised within the framework provided by the four determining variable categories discussed in subsection 6.2.2.

Since modifying a train's route may also induce a temporal modification in its schedule, the implementation of the measure has the potential to introduce spatiotemporal adjustments on the scheduled operations. Accordingly, the measure is prone to induce train delays and further occupancy as well as circulation conflicts. Furthermore, given that the measure may entail changing a train's originally scheduled platform track where passenger exchange was foreseen, its implementation must take these changes into consideration. As a result, the following determining variables are considered:

- Train delay (Temporal)
- Changes of platform tracks (Spatial)
- Changes of routes (Spatial)
- Follow-up occupancy conflicts (Look-Ahead)
- Follow-up circulation conflicts (Look-Ahead)

Dispatching time

The rerouting of a train across the infrastructural elements that are found within the train's journey time interval equal to the time span between the system's deployment time $t_{0,TD}$ and the minimum communication time $\min t_{Comm}$ may not be utilized, since it cannot be guaranteed that the necessary orders are successfully transmitted to the driver. This restriction can be removed in correspondence to the actual implementation needs of the system.

Additionally, the modification of platform tracks must be conducted not only observing the minimum communication time but also considering the minimum transit time for passengers between platform track (see subsection 3.6.2).

6.3.12. Alternative Train Service – (ATS)

Description of the type of action and possible impact

An alternative train service is a measure that entails the development of a provisional schedule to be appointed to a vehicle or vehicle composition. The measure permits to solve conflicts by allowing trains to move throughout the disrupted network without following any existing schedules, thus, providing a flexible approach to the disruption-management process.

Through the implementation of an alternative train service, vehicles or vehicle compositions are routed through, from and towards strategic locations in the network. This makes the implementation of the measure to be particularly relevant at the vehicle-specific level. While it can be utilized to solve occupancy, circulation and service conflicts, developing a completely new schedule so that the movement of a train abides with the operational constraints of the network (e.g. minimum headway times) or as the means to limit its overall delay, has very limited practical relevance. Therefore, within the dynamic DRP deployment system, the measure may be utilized to solve conflicts within the critical areas of the network, which would benefit from the incorporation of a flexible alternative (see subsection 3.6.2). By focusing on the critical area, the measure would further support the system's transition to stable operations.

Check for feasibility and quantification of the approach

Prerequisites for its implementation:

As discussed above, the implementation of the measure would have particular relevance if deployed within the critical as the means to facilitate the specific handling of trains that are prone to induce the train queues, thus, supporting the transition of the system to stable operations.

In this regard, the handling of trains that generate positive turns at the technically feasible turning stations within the critical area, are of importance. Positive turns take place when trains must wait for their scheduled departure time at the platform track after they have completed their transition between train services. Therefore, by utilizing an alternative train service, the measure would permit to remove these trains from the critical area before their scheduled departure time and find a better location for them to wait for their scheduled departure time.

The implementation of the measure entails acknowledging the operational constraints that outline what constitutes a train service (see subsection 3.6.2). As any other train service, the development of an alternative train service requires to consider: a train number, a beginning as well as an end station, any specific intermediate locations throughout the network to be reached by the train, one route linking beginning, intermediate and ending nodes, and establishing the scheduled arrival, departure as well as stopping times throughout each of the nodes. Furthermore, as with the exploration of routing and deviating alternatives (see subsection 6.3.11), the technical and operational characteristics of the route also play an important role.

Solution approach:

At the outset, a train number from the stock of special train numbers must be singled out (see subsection 3.6.2). Next, depending on the operational circumstances to which the measure is applied, the beginning and end nodes or locations in the network must be identified. The beginning station would be the station in the critical area from where the train wants to be removed. On the other hand, the end station must be selected by considering the actual operating situation; nonetheless, the station must be outside of the critical area and form part of the original route respective to the affected train's line.

Once the beginning and end location of the schedule have been located a feasible arrangement of nodes linking these two points and the route along with these nodes must be established. This process entails the exploration of possible routing alternatives for the affected train. This can be conducted as discussed for the rerouting of a train in subsection 6.3.11, or new heuristic rules may be established.

Later, the projection of the train movement throughout the alternative route would inherently derive the arrival, departure and stopping times throughout the specific nodes. The projected arrival and departure times are inherently dependent on the schedule which the affected train has assigned at the moment the measure is implemented.

Ultimately, once the alternative schedule has been developed, the original schedule appointed to the affected train is modified accordingly. This entails removing from the affected train's original schedule the portion of the route, which is to be covered by the alternative schedule and introduce the alternative instead.

Combinability

For the development of the alternative train service, the measure can make use of the shifting of a train in time (see subsection 6.3.8), the bending of a train (see subsection 6.3.9), the cancellation of a stop (see subsection 6.3.10) and the rerouting of the train (see subsection 6.3.11).

Ultimately, the implementation would inherently lead to the partial cancellation of portions of the originally scheduled route of the train service replaced by the alternative train service. Therefore, the partial cancellation of train services is an inherent consequence of the implementation of the measure (see subsection 6.3.5).

Robustness

The measure enhances the flexibility with which the disruption-management may be conducted. Its implementation allows the strategic movement of vehicles or vehicle compositions around the network in order to uphold its ability to deal with its disrupted capacity, supporting the transition towards stable operations.

Nevertheless, since the affected train moves across the network without following any existing schedule, the original train service must be cancelled between the beginning and end stations of the alternative train service. Therefore, the implementation of the measure comes in detriment to the line's serviceability and immediately affecting the welfare of its passengers.

Furthermore, the alternative movement of the train throughout the network would increase its likelihood of generating occupancy or circulation conflicts. Thus, the measure may also induce a negative influence on the robustness of the network.

From an operational perspective, once applied, it is difficult to modify or retrieve the measure. Therefore, just as with the early turn of trains or the transfer between sides, the measure is in itself very robust.

Determining variables

The type of action and overall approach of the measure must still be appraised within the framework provided by the four determining variable categories discussed in subsection 6.2.2.

The development of an alternative train service would induce spatiotemporal adjustments on the scheduled operations. Accordingly, the measure is prone to induce, train delays, changes in routes and platform tracks. Furthermore, due to the spatiotemporal adjustments, the measure is also likely to induce direct occupancy and circulation conflicts. Moreover, since the measure inherently requires that portions of the route of the involved train services are cancelled, the measure would most certainly leave certain stations along the train's route without being serviced. As a result, the following determining variables may be considered:

- Train delay (Temporal)
- Changes of platform tracks (Spatial)
- Changes of routes (Spatial)
- Number of cancelled stops (Malus)
- Follow-up occupancy conflicts (Look-Ahead)
- Follow-up circulation conflicts (Look-Ahead)
- Follow-up service conflicts (Look-Ahead)

Dispatching time

The use of an alternative train service can be conducted without any further limitation.

6.3.13. Transferring Passengers' Waiting Time – (TPW)

Description of the type of action and possible impact

The transference of the passengers' waiting time is a measure that supports the handling of service conflicts and allows the system to take the effects generated by the cancellation of a train service into consideration. Overall, the measure is not intended as an operational solution to guarantee that the maximum service interval is respected (see subsection 3.7.2). Instead, the measure is focused on supporting the system's ability to represent and keep track of the effects induced by the cancellation of a train service on the passengers' welfare.

The measure represents the effects induced by the cancellation of a train service by establishing the passengers' waiting time for the subsequent train service at each of the affected stations. Additionally, the measure effectively links the cancelled train service and the subsequent train service so as to keep track of the passengers' waiting time that has been transferred between train services. The identification of the subsequent train service has been discussed as the mean to derive the service interval induced by the cancelled service (see subsection 3.7.2).

Since the transference of the passengers' waiting time is implemented on specific trains, the measure has particular relevance at the vehicle-specific operational level. More explicitly, the measure provides an approach capable of addressing service conflicts.

Check for feasibility and quantification of the approach

Prerequisites for its implementation:

The measure should be implemented at each station affected by a partial or total cancellation of a train service where a service conflict has been generated. Aligned with the system requirements (see subsection 3.4.2), shifting the passengers' waiting time t_{pw} should contemplate the operating situation at each of the stations affected by the cancellation of a train service.

The implementation of the measure requires to establish the subsequent train service reaching the affected station after the cancellation of a train in order to ascertain the overall amount of the passengers' waiting time that should be transferred. For a better understanding, the determining variables that allow establishing the existence of service conflicts must be briefly discussed (see subsection 3.7.2).

As discussed in subsection 3.7.2, a service conflict is generated if the cancellation of a train service at one or multiple train stations generates a service interval that surpasses the maximum service interval allowed by the system. In general terms, the cancellation of a train service Q at a station S_a generates a service interval $t_{SI}^{S_a}$ (i.e. timespan between the previous and subsequent train service). The temporal magnitude of the generated service interval $t_{SI}^{S_a}$ is compared against a maximum service interval $t_{SI,max}$. A service conflict exists if the generated service interval $t_{SI}^{S_a}$ is larger than the maximum service interval $t_{SI,max}$ (i.e. service interval foresaw in the DRP operating concept).

Figure 6.1 depicts a situation in which a train service (i.e. S35537) has been totally cancelled, and a service conflict has been induced. From the figure, it is possible to observe that from the seven stations affected by the cancellation of train service S35537, two stations, namely, stations G and F, are particularly affected. In stations G and F, a service conflict is induced since the generated service interval is larger than the maximum service interval.

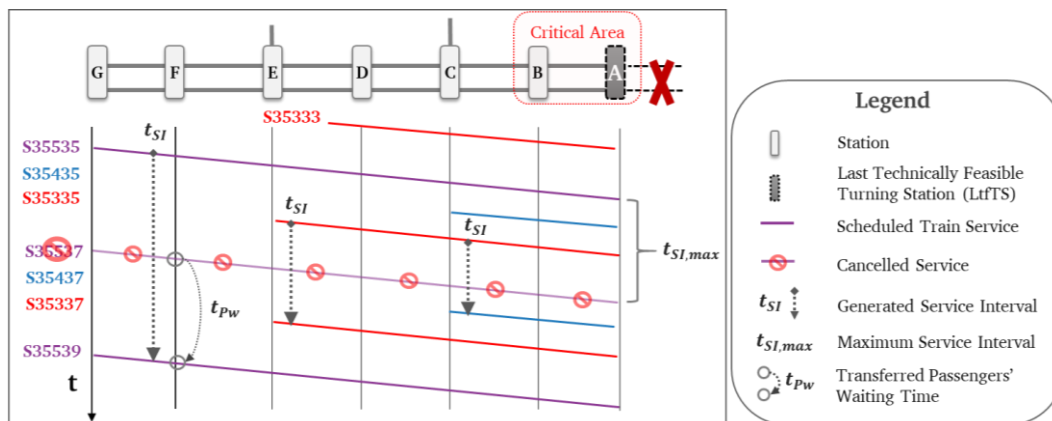

Figure 6.1 Example of the transference of passengers' waiting time after the cancellation of a train service (by author)

The identification of the prior and subsequent train service has been introduced in subsection 3.7.2, where two determining variables have been explained to convey central relevance. On the one hand, the end station of the cancelled train service. This entails that the prior and subsequent train services must have the end station of the cancelled train service within their schedules. On the other hand, the direction of travel of the cancelled train service and the stations being reached

by the prior and subsequent train services. This entails that the prior and subsequent train services should be able to reach all the stations reached by the cancelled train service along its line.

Consequently, the crucial requirement for the transference of the passengers' waiting time is the establishment of the prior and subsequent train services. The passengers' waiting time must be accounted for beyond the limit imposed by the maximum service interval. Therefore, the effective transfer of the passengers' waiting time only occurs for the timespan between the end of the maximum service interval and the departure of the subsequent service. Figure 6.1 depicts the transference of the passengers' waiting time t_{PW} . Since at stations G and F a service conflict has been identified, the passengers' waiting time t_{PW} is transferred to the subsequent train service (i.e. S35539).

Solution approach:

The implementation of the measure starts by acknowledging the prior and subsequent train services at every station where a service conflict has been identified. The identification of these train services is conducted by taking under consideration the end and intermediate stations reached by the cancelled train service, as discussed in the prerequisites subtitle.

Once the prior and subsequent train services have been established, the passengers' waiting time is established. As discussed above, the passengers' waiting time that should be transferred to the subsequent train service is equal to the time span between the end of the maximum service interval (accounted from the departure time of the prior train service) and the departure time of the subsequent train service from the station. It is important to utilize the departure time since the prior or subsequent train services may have a transition between train service scheduled at the investigated station.

Ultimately, the link between the cancelled train service Q and the subsequent service R is secured in order to track the transference of the passenger's waiting time t_{PW} .

Figure 6.2 depicts the benefit of linking the cancelled with the subsequent train services. The example presented in figure 6.2 still focuses on service S35537; however, it depicts an alternative operating situation in which train service S35337 has also been cancelled. Therefore, due to the linking of train services S35537 and S35337 in the prior figure, the cancellation of train service S35337 requires not only considering this service but also train service S35537. Ultimately, the passengers' waiting time from train service S35537 must be further transferred to service S35339 across stations E and D.

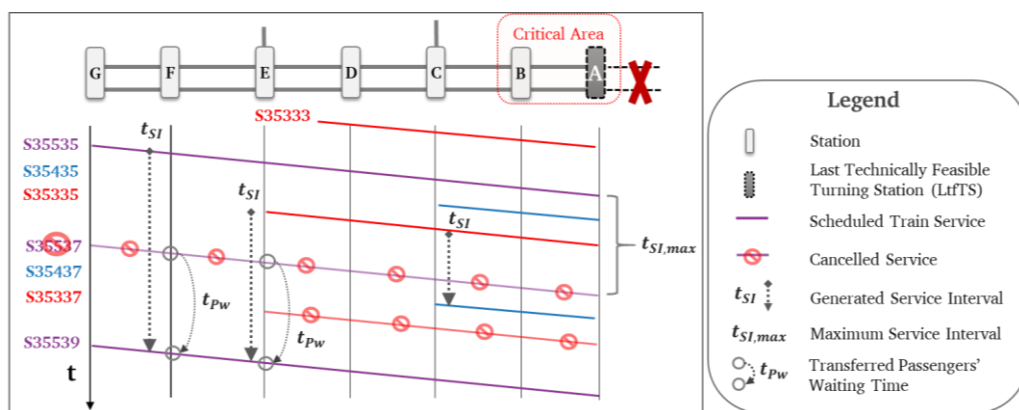

Figure 6.2 Example for the transference of passengers' waiting time of the first cancelled service after the cancellation of the linked service (by author)

Combinability

Considering that the implementation of the measure is not an active decision process but a result of other alternative solutions it can not be explicitly combined. This is exacerbated by the fact that it is the sole measure able to deal with the service conflicts.

Robustness

The transfer of the passenger's waiting time allows considering the impact of other measures throughout the implementation of the dynamic DRP deployment system. The measure supports the capability to manage and quantify the impact of measures that may induce a service conflict. Additionally, the measure also ensures a link between the disrupted passengers and subsequent services, allowing keep track of the effects of the disruption-management on the passengers at each one of the affected stations (see figure 6.1). In this way, the disruption-management and above all else, the transitioning to stable operations can also take into direct consideration the serviceability of the affected lines in the disrupted network.

Since the measure is in overall an outcome of the implementation of other measures and it can be modified together with the changes in the operating situation of the disrupted network, the measure is in itself not robust.

Determining variables

The transfer of the passengers' waiting time is in itself an extraordinary evaluating tool, and due to its built-in tracking properties, it provides the necessary means to evaluate the:

- Train Service Cancellation (Malus)
- Number of cancelled stops (Malus)

Dispatching time

The measure can be conducted without any further temporal limitation.

6.3.14. Overview of the Measures

Table 6.1 summarizes the general results from the structured examination of each of the elemental conflict solution alternatives conducted by means of the framework described in 6.2.2. The table provides with an overview of the implementation of all fourteen measures within a disruption examined for their use within the dynamic DRP deployment system.

In table 6.1, the first and second columns provide respectively with the examination number and abbreviation of each one of the measures according to their examination within this subsection. The third column highlights the operational level within the dynamic DRP deployment system in which their implementation is most purposeful. The fourth column provides the possible conflict types that can be addressed by each measure. The fifth column summarizes the combinability between measures to adjust the schedule of one single train, yet it displays the combinability of the measures only in one direction with respect to the measure that first appears in the table. Finally, column six explains the effects of implementing the measures by detailing the need to implement another measure.

Table 6.1 Summary of the fourteen elemental conflict solution alternatives examined throughout subsection 6.3 to address conflicts across the line-specific and vehicle-specific operational levels (by author)

N°	Measure	Relevant Operational Level	Relevant Conflict Types	Combinability	Influence on other Measures
1	ETL	Line-Specific	VAC; RC	IET; PT; ETT; DCT	CS
2	IET	Line-Specific	VAC; RC	ETT	-
3	PT	Line-Specific	VAC	ETT; CT	-
4	TT	Line-Specific	VAC; RC	-	CS
5	CS	Line-Specific / Vehicle-Specific	VAC; RC / CC	-	TPW
6	ETT	Line-Specific / Vehicle-Specific	RC / OC; CC	DCT / STT; BT; RRT	CS
7	DCT	Line-Specific	VAC; RC	-	-
8	CT	Line-Specific	VAC	-	CS
9	STT	Vehicle-Specific	OC; CC	RRT ; ATS	-
10	BT	Vehicle-Specific	OC; CC	CTS; RRT; ATS	-
11	CTS	Vehicle-Specific	OC; CC	RRT; ATS	CS
12	RRT	Vehicle-Specific	OC; CC	ATS	-
13	ATS	Vehicle-Specific	CC	-	CS
14	TPW	Vehicle-Specific	SC	-	-

VAC: Vehicle availability conflicts; RC: Reachability conflicts; CC: Circulation conflicts; OC: Occupancy conflicts; SC: Service conflicts

With the help of the examination and the summary in table 6.1, the groundwork for the establishment of the elemental conflict solution bundles has been laid. The generation of the bundles are specified for both the line-specific and vehicle-specific operational levels by considering the system's requirements (see subsection 3.4.2). As a result, the bundling of the elemental conflict solution alternatives not only takes into consideration their relevance within but also across the investigated conflict types and operational levels, particular attention is given to the combinability and adeptness of the different measures to address more than one specific conflict type.

In subsection 6.4, the bundling of the elemental conflict solutions for the two line-specific conflict types (see subsection 3.7.2) is detailed. Correspondingly subsection 6.5 details the bundling for three vehicle-specific conflict types, namely, occupancy, circulation and service conflicts. At this stage in the development of the dynamic DRP deployment system, infrastructure availability conflicts may be included as a particular case of occupancy conflicts. Under this consideration, an infrastructure availability conflict is understood as a train that encounters an occupancy conflict with a permanently occupied infrastructural element.

6.4. Bundles of Elemental Conflict Solution Alternatives for Line-specific Conflicts

As discussed in subsection 3.5.2, advancing a system within a planned disruption-management approach requires making a clear distinction between line-specific and vehicle-specific operational levels. The line-specific operational level is based on the DRP operating concepts and their deployment on the actual disruption. The line-specific measures contained within the DRP operating concepts provide with a general framework to establish for the affected network

potential measures that can be utilized to solve both of the line-specific conflict types, namely, vehicle availability and reachability conflicts. This subsection identifies and bundles the measures discussed in subsection 6.3, which permit to solve vehicle availability (VAC) and reachability conflicts (RC).

Table 6.2 summarizes the elemental solution alternatives most relevant for solving conflicts at a line-specific operational level. The featured measures are to be bundled together within the framework of the dynamic DRP deployment system, thus, establishing a set of predefined elemental conflict solution alternatives for each of the line-specific conflict types. In addition, in the examination of the combinability of the measures throughout subsection 6.3, it has been established that a conflict solution can be utilized to address more than one conflict type. This characteristic must be considered during the structuring of the respective measure bundles.

Table 6.2 Summary of the eight elemental conflict solution alternatives to address line-specific conflicts (by author)

N°	Measure	Relevant Operational Level	Relevant Conflict Types
1	Exchanging Train Between Lines (ETL)	Line-Specific	VAC; RC
2	Incorporating and External Train (IET)	Line-Specific	VAC; RC
3	Removing and Parking Train (PT)	Line-Specific	VAC
4	Transferring a Train (TT)	Line-Specific	VAC; RC
5	Canceling a Train Service (CS)	Line-Specific	VAC; RC
6	Early Turning a Train (ETT)	Line-Specific	RC
7	Decoupling a Train (DCT)	Line-Specific	VAC; RC
8	Coupling a Train (CT)	Line-Specific	VAC

VAC: Vehicle availability conflicts; RC: Reachability conflicts

The following subsections 6.4.1 and 6.4.2, detail the bundling of the elemental conflict solution alternatives displayed in table 6.2 within each one of the line-specific conflict types.

6.4.1. Elemental Conflict Solution Alternatives for Vehicle Availability Conflicts

Vehicle availability conflicts, as discussed in subsection 3.7.2, are the direct result of ascertaining the number of vehicles or vehicle combinations required for servicing the operating program of a line and side (if applicable) as foreseen by its DRP operating concept (see subsection 5.3 and 5.4). Therefore, vehicle availability conflicts allow ascertaining the existence of either a surplus or lack of vehicles for a given line and side (if applicable).

Among the eight elemental conflict solution alternatives detailed in table 6.2, seven support the capability to solve vehicle availability conflicts at a line-specific level. Furthermore, from their structured examination in 6.3, all seven measures can be further detailed vis-à-vis their ability to cope within either a surplus or lack of vehicles.

Initially, from the seven measures, two are recognized to have the explicit capability to solve the surplus availability of vehicles in a disruption, namely, the coupling of trains (CT) and the removal and parking of a train (PT). Moreover, three solution alternatives are distinguished as per their exclusive potential to solve a lack of trains; these are: incorporating an external train (IET), the cancellation of a service (CS) and the decoupling of a train (DCT). At last, the two remaining

measures, namely, the exchange of trains between lines (ETL) and the transferring of a train between sides (TT), solve simultaneously the lack and surplus of vehicles across sides of a line in a disruption divided network or even between corresponding lines (see subsection 3.6.2).

Having considered the overall abilities of the seven elemental conflict solution measures for coping with vehicle availability conflicts, two general characteristics can be recognized. Initially, each of the measures addressed a different aspect of vehicle availability, tackling a lack, surplus or even both circumstances together. Moreover, the alternatives can either have a direct influence over a single line, and side (if applicable), or influence across different lines and sides (i.e. corresponding lines). These two characteristics can set the groundwork for the bundling of the elemental conflict solution alternatives.

While the two characteristics discussed above would be sufficient to arrange the measures in a bundle, existing dispatching practices underline the relevance of contemplating the implementing effort, requirements, and effects on the operating situation of each of the measures. These characteristics become critical during the exploration of potential solution alternatives, particularly in the strenuous context of disrupted operations (Stemer 2018). On the one hand, the effort behind the implementation of the measures and their requirements has been discussed within the feature “Check for feasibility and quantification of the approach” throughout subsection 6.3. There are some measures whose implementation must consider the fulfillment of a broad range of prerequisites (e.g. transferring trains between sided – see subsection 6.3.4). On the other hand, the effects of the measures on the operating situation have also been discussed within the feature “robustness” throughout subsection 6.3. There are some measures that influence the robustness of the network in ways they may even become detrimental to the service quality (i.e. cancellation of a train service – see subsection 6.3.10).

As a result, the measures are bundled not only following their adeptness to deal with a lack or surplus of vehicles and address the situation across its corresponding lines as well as sides, but ultimately, observing their implementation effort. Figure 6.3 displays the resulting bundle of measures following the above-explained arrangement. The bundle distinguishes between a surplus or lack of vehicles and their potential interaction between the same or corresponding lines. Furthermore, the bundle incorporates a hierarchical division in which the first and the second levels are preferred as they host “less complex” solutions. Measures within the third level not only have a considerable impact on the operational condition of a line and higher implementation requirements, but also an effect on the commuter railway network’s operations and serviceability as a whole. The transfer of a train in the case of surplus vehicles is the only exception in which the hierarchy is not directly applied since the measure depends on a lack of vehicles in the line’s opposite side in a disruption divided network.

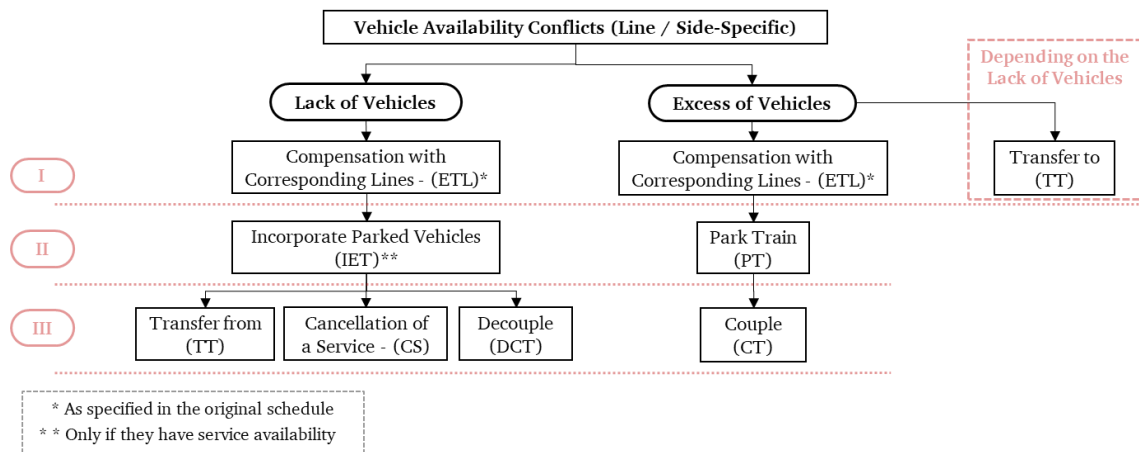

Figure 6.3 Bundle of elemental conflict solution alternatives for vehicle availability conflicts arranged in a hierarchical structure (by author)

Within the context of the dynamic DRP deployment system, both the dissolution or preservation of the hierarchical structure depicted in figure 6.3 would come with its benefits and drawbacks. A clear benefit is that by keeping the hierarchical structure, the computational times are limited, as the exploration of solutions is limited to the different levels (see subsection 3.4.2). On the other hand, it is possible that potential operational stability can be achieved faster through the implementation of a non-assessed solution, or even unexplored solutions could potentially be more effective alternatives for the system as a whole (see subsections 3.2.2 and 3.3.2).

In general, there are three paths to modify the above-explained hierarchical bundling structure. Firstly, the different levels can be merged together; in this case, the alternatives that would still support to some extent the operational relevance of the introduced hierarchy would result from the fusion of the first and second, or second and third levels together. Secondly, new hierarchical levels can be instituted. For example, a fourth level can host the solution alternative with the highest implementing effort (i.e. transfer of a train as evidenced in 6.3.4), reducing the computational time even further. Thirdly, eliminating the hierarchy, allowing all possible solutions to be explored.

The hierarchical structure depicted in figure 6.3 has been pre-emptively verified based on practical examples considering that during the deployment of DRPs different tasks take place simultaneously and require immediate action on behalf of dispatchers. The examples consisted of the handling of the trains of a set of corresponding lines affected by a disruption within a commuter railway network. The handling of the trains involved the establishment of the best fitting line-specific measures to address the vehicle availability, and subsequently, reachability conflicts, following two different approaches. On the one hand, utilizing the three-level hierarchy displayed in figure 6.3, and on the other hand, a generalized exploration of all measures. The selection of the measures in both of the considered cases delivered a very similar selection of solutions, and as expected, the generalized exploration of all measures required substantially more time.

The sole exception in the list of potential solutions established between the two approaches was the transferring of trains between sides. This measure was listed as a possibility when all measures were explored but failed to be reached with the hierarchical exploration. While the utilization of transference between sides provides with a potential betterment on the handling of the trains in the investigated example, its appraisal took considerable time and its precision was only feasible as the exact length of the duration of the disruption was known. In practice, the duration of the disruption is merely an approximation that cannot be established with accuracy (see subsection

2.3), which further weakens the benefits of immediately investing time into computing the transference duration of a train from one side to another every time.

While the disadvantages of utilizing the hierarchical structure entail that the establishment of potential line-specific conflict solutions is subjected to a discriminate evaluation and subsequent selection of measures (i.e. not considering all alternatives), the heuristic benefits of implementing the hierarchical structure, as established by the example, support its utilization. Therefore, for the subsequent development of this work, the hierarchy is maintained as the incumbent structure; still, it may be changed in correspondence to the needs of the implementing context.

Relying on the hierarchical structure, once a line-specific elemental conflict solution has been selected for a specific line and side (if applicable), it can be implemented to any train of the respective line in correspondence to its actual location. Nonetheless, the exploration of further solutions for the same line in the hierarchy must be conducted until the surplus or deficit vehicles for the investigated line have been accounted for. For example, if an investigated line has a lack of two trains and its corresponding line has a surplus of one train, the measure ETL would not be enough to solve the vehicle availability conflict, and the measure IET must be considered.

Having established the bundle of elemental conflict solution alternative measures for vehicle availability conflicts, the same process is conducted in the following subsection for the remaining line-specific conflict type.

6.4.2. Elemental Conflict Solution Alternatives for Reachability Conflicts

Reachability conflicts, as discussed in subsection 3.7.2, result from ascertaining the train services that began their service before the implementation of the system and are not capable of reaching their end station due to the existence of a complete blockage and/or the consequential separation of their lines into two different sides as detailed by their DRP. Thus, reachability conflicts evidence the train services on each side of a disruption divided line that require the reallocation of vehicle resources.

Considering that reachability conflicts embody the affected services which have no vehicle assigned on a specific side of the disrupted line, six from the eight elemental conflict solution alternatives detailed in table 6.2 allow solving the conflict. The main share of the measures has been singled out considering their capability to reallocate trains for the affected services. Five from the six elemental conflict solutions allow the establishment of replacement trains, namely, exchange of trains between lines (ETL), incorporating an external train (IET), transferring a train between sides (TT), early turning a train (ETT) and decoupling a train (DCT). Nonetheless, the cancellation of a service (CS) stands as a proficient complement as it allows dealing with an affected service by completely or partially removing it from further consideration.

As with vehicle availability conflicts, reachability conflicts are in overall subordinate to the actual operational circumstances. Therefore, the handling of reachability conflicts is also conducted under a lack or surplus of vehicle resources. While in the case of a surplus of resources, there is ample opportunity for the establishment of replacement trains, the lack of vehicles inherently links the implementation of measures with the hierarchical structure of vehicle availability measures' bundle (see subsection 6.4.1). Consequently, the bundling of the six elemental conflict solution alternatives must be framed within this dependence.

At the outset, whereas five of the six measures are directly linked to the establishment of a replacement train, the cancellation of a service can be made independently from vehicle availability. Thus, a cancellation can be explored regardless of vehicle availability. This is also the case of an early turn since it can be implemented to any available train regardless of the vehicle availability. The remaining four elemental conflict solution alternatives are dependent on their prior consideration as alternative solutions within vehicle availability conflicts; thus, they are only considered as viable measures to address reachability conflicts if they form part of the solution alternatives respective to the investigated line's side vehicle availability strategies.

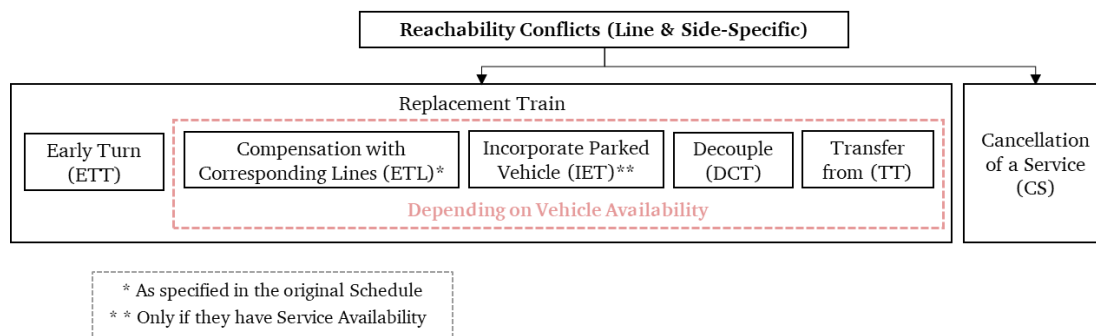

Figure 6.4 Bundle of elemental conflict solution alternatives for reachability conflicts (by author)

As a result, figure 6.4 displays the bundling of the six considered measures, where two general standpoints can be observed, namely, measures that foresee the establishment of replacement trains for an affected service and the measure that considers the cancellation of such service. Since the bundle of measures includes four elemental conflict solutions that depend on the vehicle availability conflicts, the overall structure of the bundle cannot be solely limited to a consideration of each measure's ability to address reachability conflicts. This is due to the reliance on the vehicle availability conflicts and the prior consideration of its alternative solutions, which in turn leads to an eradication of their hierarchy at this level.

The four measures dependent on vehicle availability conflicts are only available once they have been selected to address a line's lack or surplus of vehicles for its respective side (if applicable), as discussed in subsection 6.4.1. Therefore, within the group of five measures that contemplate the possibility of establishing a replacement train, four alternative solutions are isolated vis-à-vis their dependence on vehicle availability conflicts. Furthermore, since reachability conflicts amount to specific train services, an examination performed at the line-specific level would imply that all six measures may be potentially implemented to solve the identified conflicts. As a result, all six measures can be effectively positioned at the same level.

For example, if there is a lack of vehicles on a line's side, and the total number of lacking vehicles can be accounted for by exchanging a train from a corresponding line, the reachability conflict has only three alternative solutions available, namely, an early turning one of the line's trains, cancelling the affected service or allocating the service to the train from the corresponding line.

Since the established bundle of elemental conflict solution measures for reachability conflicts positions all measures at the same level, the resulting structure is non-discriminatory. In this regard, any further modification on the bundle's structure would need to be adequately justified, as it was the case with the hierarchical structure of the vehicle availability alternative solutions.

To this point, the elemental conflict solution alternatives for each of the line-specific conflict types have been proficiently clustered into their respective bundles. The clustering process of the

elemental conflict solutions into bundles to address both vehicle availability and reachability conflicts may serve as a general example for the bundling of elemental solution alternatives across the three main conflict types at the vehicle-specific level, which is detailed in the following subsection.

6.5. Elemental Conflict Solution Alternatives for Vehicle-Specific Conflicts

As discussed in subsection 3.5.2, the disruption-management at the vehicle-specific operational level implies implementing the potential conflict solutions established at the line-specific level to every single train circulating in the disrupted network. In other words, all trains assigned to service a particular line can be attributed with a set of alternative solution measures relative to their actual location in the network so as to address their line’s operational circumstances.

The implementation of the line-specific solution alternatives at a vehicle-specific level intrinsically entails considering the network’s operational constraints (e.g. minimum headway times, minimum transition times, etc.). As discussed in subsection 6.3.14, in the context of this work, the operational constraints are summarized within the three general conflict types at the vehicle-specific level, namely, occupancy conflicts (OC), circulation conflicts (CC) and service conflicts (SC).

Table 6.3, retrieves from table 6.1 (in 6.3.14) the elemental solution alternatives aimed at solving vehicle-specific conflicts. In order to enhance the development of conflict resolution alternatives at the vehicle-specific level, the measures featured in the table are to be bundled together. The clustering of the measures into concrete bundles is aligned with the requirements and limitations of the dynamic DRP deployment system (see subsections 3.3.2 and 3.4.2), establishing a set of elemental conflict solution alternatives for each of the three vehicle-specific conflict types.

As with the bundling of the line-specific elemental conflict solutions, the bundling of the eight measures displayed in table 6.3 must consider the combinability between measures and their potential implementation to address more than one conflict type, as discussed throughout the respective subtitles throughout subsection 6.3.

Table 6.3 Summary of the eight elemental conflict solution alternatives to address vehicle-specific conflicts (by author)

N°	Measure	Relevant Operational Level	Relevant Conflict Types	Combinability (on one single train)
5	Cancelling a Train Service (CS)	Vehicle-Specific	CC	-
6	Early Turning a Train (ETT)	Vehicle-Specific	OC; CC	STT; BT; RRT
9	Shifting a Train in Time (STT)	Vehicle-Specific	OC; CC	RRT; ATS
10	Bending a Train (BT)	Vehicle-Specific	OC; CC	CTS; RRT; ATS
11	Cancelling a Train Stop (CTS)	Vehicle-Specific	OC; CC	RRT; ATS
12	Rerouting a Train (RRT)	Vehicle-Specific	OC; CC	ATS
13	Alternative Train Service (ATS)	Vehicle-Specific	CC	-
14	Transferring Passengers’ Waiting Time (TPW)	Vehicle-Specific	SC	-

CC: Circulation conflicts; OC: Occupancy conflicts; SC: Service conflicts

Subsections 6.5.1, 6.5.2 and 6.5.3 discuss the bundling of the elemental conflict solution alternatives displayed in table 6.3, respectively, for each of the three vehicle-specific conflict types.

With the successful bundling of the eight solution alternatives, all available measures would have been grouped in specific bundles, facilitating the handling of the disrupted operational circumstances.

6.5.1. Occupancy and Infrastructure Availability Conflicts

Following the conventional understanding of occupancy conflicts, as discussed in subsection 3.6.2, these conflicts contemplate, for the most part, an overlapping of the blocking times of two trains across specific infrastructural components. In nodes, the simultaneous occupancy of an infrastructural component can be extended to include more than two trains, leading to a much more complex situation.

From the eight elemental conflict solution alternatives featured in table 6.3, five measures are capable of solving occupancy conflicts at a vehicle-specific level. In the following, these elemental conflict solutions are investigated towards establishing their ability to introduce the necessary adjustment to the scheduled train services and solve occupancy conflicts.

Two elemental conflict solution alternatives tackle occupancy conflicts explicitly from a temporal perspective, namely, shifting trains in time (STT) and bending of trains (BT). The rerouting of a train (RRT) is the sole alternative that handles the conflicting situation from unequivocally a spatial perspective. The remaining measures, early turning a train (ETT) and cancelling a stop (CTS), are a mix between both temporal and spatial perspectives. The alternatives can be combined with each other to solve any occupancy conflict. Their combinatorial possibilities have been further detailed throughout their examination, and a brief summary is displayed in table 6.3.

Having contemplated the five elemental conflict solution measures for the handling of the occupancy conflicts as understood within the dynamic DRP deployment system, three general remarks can be derived.

1. Measures that exclusively entail a temporal perspective (i.e. STT and BT) are not able to solve infrastructure availability conflicts. Therefore, these measures can only be applied if combined with other non-temporal measures.
2. Within the scope of the dynamic DRP deployment system, the bending of trains (BT) cannot be supported as a plausible elemental conflict solution alternative. While it supports a much more detailed development of solutions, particularly from a capacity oriented perspective, its implementing effort and the level of detail within the information required for its adequate processing (e.g. infrastructure modelling detail) are not aligned with the general approach of the system (i.e. fixed speed models - see subsection 3.5.2).
3. Due to its robust influence on the passengers and their welfare and the very limited benefit as discussed in subsection 6.3.10, the cancellation of train stops (CTS) would not be utilized as an elemental conflict solution attentive to solve occupancy conflicts.

The three remaining measures are clustered together, constituting a bundle of elemental conflict solution measures for occupancy and infrastructure availability conflicts. The resulting bundle is displayed in figure 6.5, where a possibility for their combination is also contemplated. At the outset, all measures are placed at the same level, in view that all have the potential to address any occupancy conflict. However, depending on aspects, like for example, the number of trains involved in the conflict, the infrastructural component in which the conflict has been identified or the location in the network in which the conflict has taken place (among others), certain elemental conflict solution alternatives would gain further relevance. Consequently, the order in which the

measures are explored is left to be established in the respective conflict resolution algorithms where the measures are being incorporated.

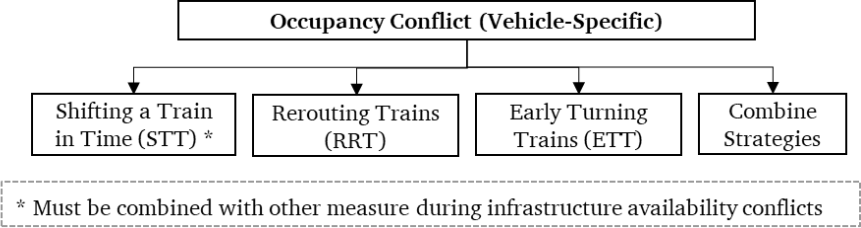

Figure 6.5 Elemental conflict solution alternatives for occupancy and infrastructure availability conflicts (by author)

All in all, with the specific purpose of further securing the implementation relevance of the bundle, particularly within further modules of the dynamic DRP deployment system, its structure can still be adjusted relative to the conflict resolution algorithm. Potential adjustments may focus on distinguishing the impact on the operating situation and the implementing effort of the elemental conflict solution alternatives; in this regard, an RRT or ETT may become prove to be challenging.

6.5.2. Circulation Conflicts

A circulation conflict, as discussed in subsection 3.6.2, entails a situation in which a train is not able to follow its originally scheduled transference of vehicles between one train service to another; for instance, the coupling of trains, or turning a vehicle between two consecutive train services. Generally, circulation conflicts take place at nodes.

From the eight elemental conflict solutions detailed in table 6.3, seven measures are capable of solving circulation conflicts at a vehicle-specific level. In the following, these elemental conflict solutions are investigated towards establishing their ability to introduce the necessary adjustment to the scheduled train services and solve circulation conflicts.

As for occupancy conflicts, these measures can also be differentiated between those who mainly support the temporal (i.e. STT or BT), spatial (i.e. RRT) or spatiotemporal (i.e. ETT, CTS) handling of the identified conflict. For the reasons already discussed within the occupancy conflicts, the bending of a train (BT) and the cancelling of a train stop (CTS) are also left aside as plausible solution alternatives to solve circulation conflicts. Nonetheless, in the case of circulation conflicts, two measures, which support the handling available vehicle resources at the vehicle-specific level, are also considered, namely, the (partial) cancelling a train service (CS) and developing an alternative train service (ATS). The combinatorial possibilities of every measure are displayed in table 6.3.

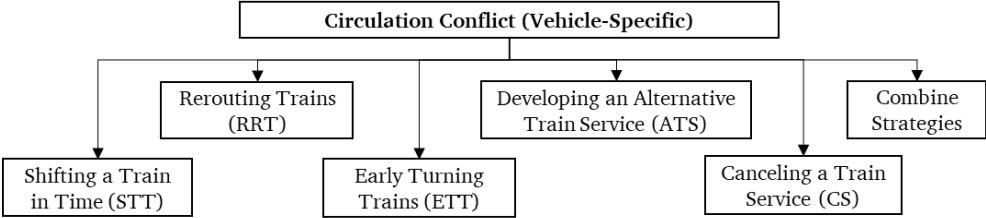

Figure 6.6 Bundle of elemental conflict solution alternatives for circulation conflicts (by author)

The implementation of the five elemental conflict solutions at a vehicle-specific level and their combinatorial possibilities are relative to the operational circumstances in which the circulation conflict takes place. Therefore, the resulting bundle of elemental conflict solution alternatives

displayed in figure 6.6 maintains all measures at the same level of relevance. Just as in occupancy conflicts, depending on the incorporation of the bundle into a conflict resolution algorithm, the structure of the bundle may be adjusted, as required.

6.5.3. Service Conflicts

As discussed in subsection 3.4.2 and 3.5.2, since connections are rarely established due to the dense nature of the commuter railway operating programs, the dynamic DRP deployment system must establish a different framework to track and further uphold the service quality of the disrupted network from the passengers' perspective. As a result, as detailed in subsection 3.7.2, a new conflict type is introduced in the system at the vehicle-specific level, namely, service conflicts.

Service conflicts arise when a train fails to reach any of the stations detailed in its schedule as the product of a total or partial cancellation of the train service (i.e. including the cancelling of a train stop).

Among the eight elemental conflict solution alternatives detailed in table 6.3, only one is capable of solving an identified serviceability conflict. This measure is the transferring of the passenger's waiting time between train services (TPW). The measure provides the system with the capacity to track the cancellation of one or more train services at specific stations and project the effects of implementing an elemental conflict solution to solve a specific conflict type, on the passengers. Finally, as the only measure, it is not necessary to create a bundle in this specific case.

6.6. Closing Remarks

This section provided a detailed discussion regarding the elemental conflict solution alternatives to be implemented in the dynamic DRP deployment system. Throughout this section, a structured approach has been utilized to examine each of the dispatching measures introduced in subsection 3.6.2 within the framework of the two operational levels handled by the dynamic DRP deployment system and its requirements. As a result, the elemental conflict solution alternatives have been successfully arranged into bundles. The resulting bundles are, in principle, not different from those used across existing CDCR approaches (see subsection 2.2.3); yet, they have been expressly developed to be implemented during disrupted operations in commuter railway networks.

The elemental conflict solution alternatives have the immediate capability to address the occurrence of conflicts in a commuter railway network. However, its implementation still requires more guidance, which cannot be left to an arbitrary assignment throughout the trains in the network. While the manual DRP deployment focuses on the immediate implementation of solutions across the trains circulating in the network, this task requires experienced dispatchers that have been trained to recognize and address such situations. Therefore, the bundles of elemental conflict solution alternatives stand merely as the building blocks within the wider dynamic DRP deployment system.

Furthermore, since this module is not dependent on any other module, it is less susceptible to the implementation of any changes and can be updated or retrofitted for any purpose. Possible modifications may entail, changing entirely the focus on other railway networks (e.g. long-distance, freight trains), restructuring the bundles or even adding an elemental conflict solution alternative. Nevertheless, any modification must contemplate a direct impact on the immediately associated modules (see subsection 3.5.3 – figure 3.1) and an indirect impact on the rest of the system.

The direct connection between modules has been indirectly highlighted throughout the structuring of the bundles. Particularly within the line-specific conflicts, a tight connection has been evidenced between the bundling structure of certain elemental conflict solution alternatives, the detailed identification of the actual conflicting circumstances and the time needed to develop the desired solutions. For instance, within vehicle availability conflicts (see subsection 6.4.1), the effectiveness of the hierarchical structure of the bundle relies on the detailed mapping of the conflicting situation and affects the computing time of solutions. Thus, any modification on the bundling structure, whether through the changing of its structure or the incorporation of a new measure, would have an effect on the detailed identification of the conflicting situation and the development of candidate solutions.

Conclusively, as one of the cornerstone elements utilized within the dynamic DRP deployment system, each bundle of predefined elemental conflict solution alternatives turns into the cutting-edge of the proposed disruption-management process.

7. DRP Set-up

7.1. Introduction

As discussed in subsection 2.3.3, the DRP set-up consists of the identification of the infrastructural elements utilized by the line-specific measures of the chosen DRP (e.g. turning stations, deviation points, etc.) and the categorization of trains in the three general categories (see subsection 2.3.3 - Oetting and Chu 2013). The categorization of the trains is conducted based on their actual location in the network vis-à-vis the infrastructural elements relevant for their line's DRP operating concept. In this subsection, a DRP set-up module aligned with the dynamic DRP deployment system's requirements and limitations (see subsection 3.3 and 3.4) is derived and discussed in detail.

The DRP set-up module is framed within the approach introduced in subsection 2.3.3. The existing approach concentrates on two specific tasks. Initially, it seeks to identify the infrastructural elements (i.e. DRP relevant infrastructural elements – see subsections 3.7.2 and 5.3.1) utilized by the line-specific measures of the chosen DRP operating concept for each affected line. Furthermore, evaluating the dispatching success of the circulating trains within the chosen DRP operating concept during the transition towards stable operations by clustering each train into one of three clusters (i.e. Red, Yellow, Green). Each train is introduced in a cluster by considering its actual position in correspondence to the previously identified infrastructural elements corresponding to its line.

As such, the DRP set-up is able to create a link between the actual operational circumstances of the disrupted network and the line-specific DRP operating concept for every affected line. Consequently, through the DRP set-up, the system is able to establish the initial operating situation of the network (i.e. infrastructure and vehicles) at the beginning of the disruption-management.

This subsection derives a logical structure for a semi-automated DRP set-up module as part of the proposed dynamic DRP deployment system. This section incorporates the existing DRP set-up approach discussed in subsection 2.3.2 and identifies enhancement possibilities in order to improve it according to the requirements of the dynamic DRP deployment system in such a way that the results may be utilized in subsequent modules of the system (see subsection 3.5.3). Therefore, the core objective of this section is to establish and develop adjustment potentials to be introduced within the existing DRP set-up processes so as to align them with the system's requirements (see subsection 3.4.2).

Within the context of the dynamic DRP deployment system, the setting-up of the chosen DRP in the existing operating situation entails combining the data arrangements across the static and dynamic inputs described in section 5. More specifically, the module incorporates the infrastructure model, the chosen line-specific DRP operating concepts, and information about the disruption (respectively subsections 5.1, 5.3 and 5.4).

For the establishment of the semi-automated DRP set-up module, subsection 7.2 presents an overview of the existing DRP set-up approach and identifies enhancement potentials. Later, subsection 7.3 discusses in further detail the steps in the original structure that are being enhanced.

7.2. Existing Approach for the DRP Set-up

The existing approach supporting the DRP set-up for commuter railway networks provides a foundation to guide the advancement of the overall structure of this module. While the existing

approach has been already introduced in subsection 2.3.2, this subsection provides further details regarding its logical structure and highlights specific processes in the structure for their enhancement, as part of the development of the dynamic DRP deployment system.

As it has been depicted in figure 2.5, once the DRP is declared, the system must transition to stable operations. The transition starts the moment a DRP is declared, and its line-specific measures are allocated across the respective trains. However, the measures are allocated by considering the position of the trains vis-à-vis the infrastructural elements (e.g. turning stations, deviation points, etc.). The existing set-up process allows to cluster trains in different categories to better reflect their overall situation regarding their actual position in the infrastructure.

The existing approach clusters all trains circulating in the network into one of three train categories, namely, “Red”, “Yellow” and “Green” (see subsection 2.3.3). Each train category assigns particular attributes to an investigated trains contingent on their location in the infrastructural model and infrastructural elements relevant to the chosen DRP.

Overall, the clustering of the trains into one of the three categories can be summarized in two steps:

1. Identification and flagging of infrastructural elements: the infrastructural elements that are utilized by the chosen DRP operating concepts’ measures are identified and respectively flagged across the infrastructure model.
2. Clustering: all trains in the commuter railway network are clustered into one of three categories by contrasting their actual location in the network against the DRP relevant infrastructural elements (e.g. turning stations).

As discussed in subsection 2.3.3, the resulting clusters provide dispatchers with a preliminary overview of the dispatching success of the trains and their handling possibilities during the transitional phase to stable operations.

7.3. Enhancement of the Existing Approach the DRP Set-up

This subsection recognizes potential enhancements that can be made to the existing structure in order to derive a semi-automated DRP set-up module aligned with the dynamic DRP deployment system.

From the two-step process described in subsection 7.2, two elements among the available inputs discussed in section 5 can be identified to have been particularly relevant. First, the DRP operating concept; more concretely, the infrastructural elements that are relevant to support the line-specific measures of the chosen DRP. The DRP relevant infrastructural elements have already been established in subsection 5.3.1, namely, turning stations, deviation points, and portions of the original route that are cancelled. Secondly, the disruption information, particularly regarding the actual location of the trains (see subsection 5.4).

While the existing DRP set-up structure is used to identify the dispatching success (i.e. handling possibilities and delay) of trains in correspondence with the chosen DRP’s operating concept during the transition to stable operations, the proposed system must be able to handle the disruption-management problems throughout the entire network and assemble a conflict-free schedule for all circulating trains. Therefore, the scope of the two-step DRP set-up process may be retrofitted considering the system’s overall approach and both the transitional and stable operations within

the chosen DRP (see subsection 3.5.2). The enhancement potentials can be derived from incorporating the two steps into the system's approach while respecting the two key input elements and the existing set-up structure.

The following subsections, 7.3.1 and 7.3.2, respectively, explore the enhancement of the two steps in consideration of the key elements.

7.3.1. Enhanced Identification and Flagging of Infrastructural Elements

At the outset, the DRP relevant infrastructural elements (see subsection 3.7.2 and 3.5.1) support the line-specific measures foresaw in the operating concept. However, during the initial moments of the disruption, the network must still handle the movement of train services as foreseen by the original schedule across a network with compromised capacity.

Until the traffic is adjusted to the disrupted capacity of the network and the operations have reached stability (see subsection 3.6.2), all infrastructural elements, regardless of whether or not they are utilized by the line-specific measures that constitute the DRP operating concept become relevant for the disruption-management. This implies that what constitutes a DRP relevant infrastructural element can be expanded to include the use of additional infrastructural elements that allow trains to reach the DRP pre-defined routes respective to their lines.

Up to this moment, only three DRP relevant infrastructural elements have been established, namely, turning stations, deviation points, and portions of the lines' original routes that are cancelled. Nonetheless, at the early stages of the disruption-management (once the DRP has been declared - see figure 2.5), the utilization of infrastructural elements not foreseen in the DRP operating concept would allow broadening the handling possibilities of trains throughout the network, potentially easing the transitioning to a stable operation. Consequently, incorporating further infrastructural elements is the first instance of how the existing DRP set-up structure can be enhanced.

As discussed in subsection 6.3.3, the utilization of a wider range of infrastructural elements (e.g. deviation locations and routes) for the implementation of the elemental conflict solution alternatives can be conducted pre-emptively for each DRP operating concept. The pre-emptive or offline selection of key infrastructural elements has been already utilized during the development of the operating concept of the DRP (Brauner 2019), where specific infrastructural elements are identified as relevant for the implementation of DRP operating concept (see subsection 2.3.3). The same approach can be advanced for expanding the framework that allows identifying key infrastructural elements that would allow the dynamic DRP deployment system to expand its capability for the handling of the disruption.

As a result, two orders may be assigned to better understand the relevance of additional infrastructural elements for a given line (per side if applicable). As detailed in subsection 5.3.1, those infrastructural elements relevant to DRPs are assigned first-order relevance for a specific line and constitute a baseline (see subsection 3.7.2). Then, it is possible to establish for every affected line, second-order infrastructural elements (see subsection 3.7.2). As discussed above, second-order infrastructural elements may be pre-emptively established and recognized as a complement of the first-order elements, since they may allow for widening the alternatives and facilitating a faster transition to stable operations.

However, in order to conduct a pre-emptive or offline identification of the second-order infrastructural elements, certain general aspects of the implementation of the dynamic DRP deployment system must be considered. These considerations are derived by observing the already established first-order elements in the DRP operating concepts of every affected line.

As explained in 5.3, there are three kinds of first-order elements for every line: turning stations, cancelled portions of a line's route and deviating stations, or points. It is worth noting however that the cancelled portions of a line's route depend on the stable operation of the targeted DRP operating concept, which will have already been assessed. Therefore, they do not play an important role during the transitional phase, and further alternatives do not need to be further considered.

As a result, an expanded understanding of relevant infrastructural elements is conducted for turning stations and relevant deviation points. The expanded identification and flagging of the infrastructural elements are detailed below.

- i) *Turning Stations*: DRP turning stations, which are established in the DRP operating concept of a given line, are intrinsically recognized as DRP relevant infrastructural elements. Thus, any DRP turning stations constitute first-order turning stations. However, it must also be recognized that not all trains would find themselves able to follow the DRP operating concept. For example, this is true of all yellow trains. In this regard, the stations around the disrupted section acquire particular importance for the overall handling of the disruption during its initial stages, as discussed in subsection 2.3. The two last technically feasible turning stations before the disrupted section are of the utmost importance for handling the traffic that gathers near and around the critical area (see subsection 3.7.2). Therefore, regardless of whether the disruption divides the network into two sides or not and whether the turning stations within the critical area are included in any line's DRP operating concept or not, they must be considered as first-order elements. On the other hand, all stations along a line's originally scheduled route with a relation matrix (see Matrix R in subsection 2.2.2) that allows vehicles to change their driving direction can be recognized as technically feasible turning stations of the second-order. These turning stations constitute relevant infrastructural elements for the handling of the impaired capacity of the network during the disruption.
- ii) *Relevant Deviation Locations and Paths*: A node in the infrastructural model is considered a first-order deviation point if it is used by the DRP operating concept to circumvent the disruption or reach another DRP relevant infrastructural element (e.g. turning station). These elements are especially significant since they are the location upon which the threading-in and threading-out of trains outside of their originally scheduled routes take place. However, all locations throughout the railway network that are able to bridge a line's original scheduled route with its planned DRP route or offer access to a plausible path to bypass the disrupted section modelled in the specific DRP operating concept must be recognized as deviation points of the second-order. As with the first-order deviation points, these elements can become crucial for the transitioning of the disrupted network to stable operations. Nonetheless, second-order deviation stations or locations that include infrastructural elements not reserved for commuter railway operations must be considered closely as it is almost certain that these elements will require information from different railway traffic types that circulate throughout the infrastructure (Stemer 2018).

Additionally, second-order infrastructural elements can also be identified “on-line” during the implementation of the dynamic DRP deployment system. The “on-line” identification of these elements must consider the computing effort available, and the immediate availability of second-order elements that may have been already identified “off-line”.

In this regard, there are numerous ways to impose different constraints so as to limit and steer the exploration of possible second-order elements. These constraints become important as the means to make the system’s computational effort more adaptable to the implementation circumstances. By imposing more constraints, the options are reduced; thus, there are fewer alternatives that can be considered throughout the disruption-management.

For the enhanced DRP set-up approach, specific features are presented as a possible means to steer the exploration process of different deviation routes and turning stations. By observing the requirements and limitation of the whole dynamic DRP deployment system (see subsection 3.4.2), five characteristics are identified below:

- *Type of traffic*: The type of traffic allowed to be handled by the infrastructural elements being explored can serve as a constraint. For example, if an infrastructural element is reserved for high-speed traffic, it may be immediately left out.
- *Time of day*: The time of day can also be used to restrict the exploration of infrastructural elements inside and outside of the commuter railway network. In the system, the time of day is recognized together with the deployment time of the system $t_{0,TD}$ (see subsections 5.4 and 3.6.2). For example, during the peak-hours (i.e. HVZ), certain elements of the infrastructure would have their capacity almost completely consumed by its originally scheduled operations and a deviation of disrupted trains would be detrimental.
- *Technical characteristics*: The technical characteristics can also be utilized as a constraint for restricting the exploration of infrastructural elements. For this, a distinction between hard and soft exclusion criteria, as in the approach introduced by Brauner (2019), can be established (see subsection 2.3.3). Hard exclusion criteria would allow to immediately omit certain infrastructural elements that are not compatible with the model trains utilized to service the affected lines, for example, gauge, train type, or existence of an overhead line. Soft exclusion criteria, on the other hand, do not immediately impede considering certain infrastructural elements and rather focus on technical features of the infrastructural elements, for example, length, height as well as width of platforms in stations, or the capacity consumption.
- *Distance from core area*: The location of an infrastructural element in the network or its distance vis-à-vis the core area (see subsection 3.6.2) can also be utilized as a constraint to limit the exploration.
- *Ability to link core area*: The ability of an infrastructural element to link the core area (see subsection 3.6.2) with other sections of the network or the different sides in a disruption divided network (see subsection 3.7.2) may also be utilized to impose limits on the exploration. When combined with the distance from the core area, this aspect can further demonstrate the strategic importance of an infrastructural element for transitioning to stable operations. For example, if there are potential deviation paths that would allow linking the end stations of a line, both at a considerable distance from the core area, they can potentially be left aside as this would imply that a substantial portion of the route would be left unserved.

The inclusion of the second-order infrastructural elements complements the first step of the approach and further secures the transition of the network to stable operations. All together, expanding the criteria used to identify relevant infrastructural elements allows for the consideration of a wider range of possible solutions that may be employed from the beginning of the disruption-management process.

7.3.2. Enhanced Clustering of Trains

The previous subsection sought to enhance the existing DRP set-up approach by expanding the understanding of relevant infrastructural elements. The enhancement of the clustering process focuses on the already existing train clusters introduced in subsection 2.3.3 and the way in which these are able to represent the actual operating situation. This subsection details the enhancement of the existing train clusters, as part of the dynamic DRP deployment system.

The current clustering process is conducted for all trains by comparing the actual location of a train with the DRP relevant infrastructural elements, and as a result, introducing the train into one of three existing categories (Green, Yellow or Red). With that in mind and considering the relevance of the DRP relevant infrastructural elements for the clustering of trains, the inclusion of second-order elements may also play a significant role in the clustering process. The three original clusters, namely, Green, Yellow and Red (see subsection 2.3.3), are reviewed below and aligned with the enhanced approach to identify and flag the relevant infrastructural elements.

- i) *Green Trains*: According to the existing structure, a train is clustered in the Green category if its actual location does not fall beyond the DRP turning station or deviation point indicated for its respective line and side and bearing in mind its driving direction (see subsection 2.3.3). However, during the transitional phase to stable operations, when considering the entire disruption-management process, the operating situation of Green trains cannot be described as uniform across the network. Trains driving towards the disruption undoubtedly require a much more exhaustive exploration of their handling alternatives as compared to those driving away from the disruption.

Furthermore, Green trains, which actual location places them within the core area (see subsection 3.6.2), most likely have one of the turning stations in the critical area (see subsection 3.7.2) appointed as the DRP turning station of their line. As such, the punctuality of these trains is likely to be compromised due to a very likely queuing in front of the LiFTS (see subsection 3.7.2). By further refining the category of Green trains, it becomes possible to distinguish which trains are driving towards the disrupted section at the moment the dynamic DRP deployment system is implemented. The proposed approach maintains the clustering definition, yet it foresees the partitioning of Green trains in two categories, namely: “Green” and “Green+”.

The Green+ category is comprised of trains driving away from the disruption (their punctuality is not immediately jeopardized) while the Green category maintains the normal definition. In this way, the Green category can contain trains whose punctuality, as well as their ability to strictly follow their DRP protocol, is not completely guaranteed. This is especially true for Green trains around the core area during the transition phase (see figure 2.5).

- ii) *Yellow Trains*: In the existing clustering process, Yellow trains are characterized by being located beyond their line’s indicated DRP turning station or deviation point (see subsection 2.3.3). Furthermore, depending on the magnitude of the disruption (e.g. complete

blockage - see subsection 3.7.2) and the DRP operating concept, these trains should be able to either reach their end station or up to the LtfTS. Here, second-order infrastructural elements could enable Yellow trains to reach their DRP relevant infrastructural elements. In principle, as with Green trains, Yellow trains could be separated into two groups: those who have the potential to be re-categorized as Green trains and those that inevitably will remain Yellow. Since the system's overall approach stipulates that trains must have all their handling potentials assessed, these options will be intrinsically considered. Therefore, the establishment of an additional cluster for Yellow trains provides little to no advantage for the enhancement of the DRP set-up approach.

iii) *Red Trains*: In the existing clustering process, Red trains find themselves either beyond the LtfTS or are those that are immediately affected by the cause of the disruption. As explained in subsection 2.3.3, their handling is particularly difficult, because it requires the implementation of special guidelines. However, in the case where a Red train has not been immediately affected by the cause of the disruption and only requires a 'time-out' (see Chu 2014, and subsection 2.3.3), it can still be handled during the disruption-management process. The proposed enhanced approach partitions Red trains in two categories: "Red" and "Red+". This would allow distinguishing trains that have the potential to be re-clustered either as Green+ or Yellow depending on their position in correspondence to the disrupted circumstances (i.e. the Red+ trains) from those that are completely affected and must remain Red.

It is worth mentioning that trains with the potential to be re-clustered (i.e. Red+) can be divided into two cases. First, trains which if allowed to keep driving would find themselves hindered by the cause of the disruption (i.e. re-clustered as Yellow). Second, trains which if allowed to keep driving are not hindered by the cause of the disruption and can be re-clustered as Green+. All trains that can be re-clustered as Yellow trains require a special operational handling before they could be reinserted in the network. Under these circumstances, their actual utilization within the disruption-management process cannot be guaranteed, and so, in this case, they should remain clustered within the Red category.

The above-mentioned enhancements are aligned with the existing clustering process and can be considered within the logical structure depicted in figure 7.1. Figure 7.1 depicts the decision tree used in the clustering process to introduce all trains circulating in the network, one by one, into one of the categories.

The enhanced clustering starts by ruling out the direst of circumstances and builds upon a process of elimination. The circumstances refer to the clustering of trains in train categories where their punctuality would be most likely jeopardized, as discussed in subsection 2.3.3 (i.e. Red or Yellow trains).

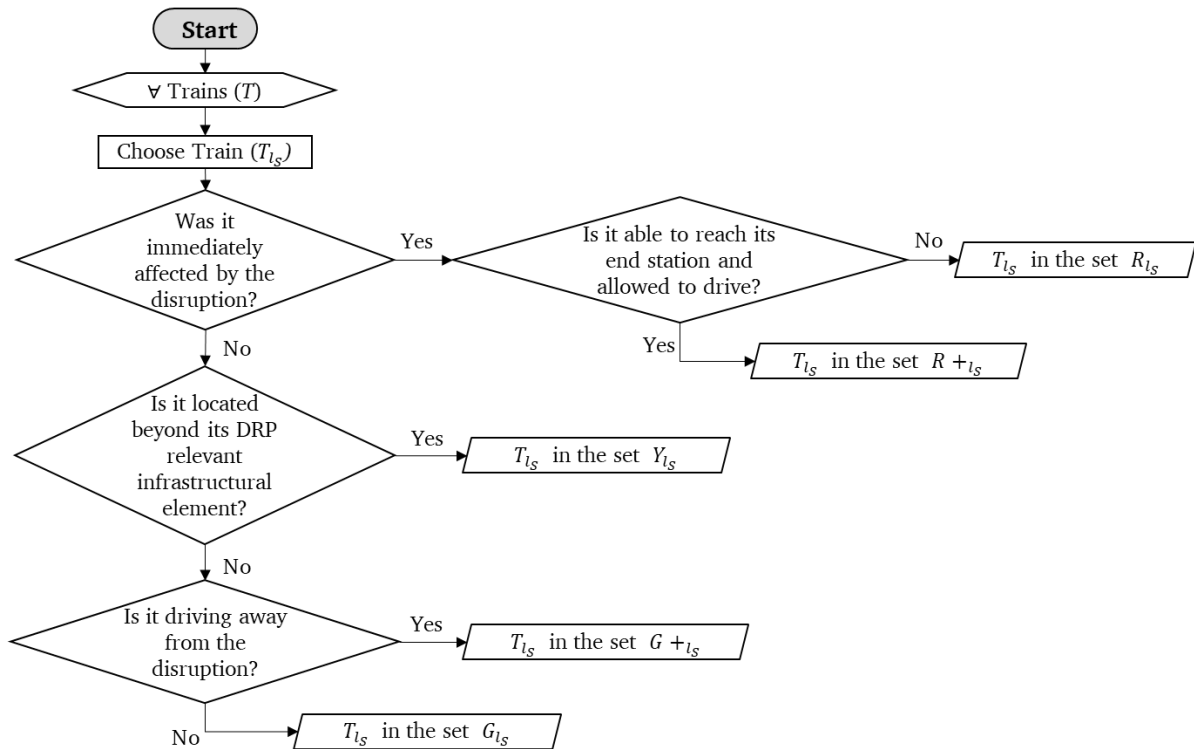

Figure 7.1 Logical structure for the enhanced clustering of trains (by author)

The clustering starts by identifying Red or Red+ trains. The clustering first considers if the train is either the cause of or has been immediately affected by the cause of the disruption. If either of these questions is answered in the affirmative, the next step is to question if the train is technically able and allowed to reach the end station respective to its appointed train service (see subsection 3.6.2). If the train is either the cause of or has been immediately affected by the cause of the disruption and/or is not able or able to reach its end station it is then automatically clustered in the line's Red category (R_{l_s}). On the other hand, if the train has the potential to reach its end station and has the potential to be shifted to a different cluster after its time-out concludes (see subsection 2.3.3), it is clustered in the Red+ category ($R+l_s$).

Next, if it can be verified that the train's actual location lies beyond its line's DRP relevant infrastructural element (e.g. DRP turning station or deviation point), the train is clustered in the line's Yellow category (Y_{l_s}). Depending on the magnitude of the disruption, Yellow trains should be able to reach their end station or at least up to the LtfTS.

Ultimately, if the train has not been introduced in the yellow category, it can be clustered into either the Green or a Green+ category. Here, it is verified if the train is currently driving away from the disruption. If this question is answered in the affirmative, the train is clustered in the Green+ category ($G+l_s$). If the question is answered in the negative, the train is clustered in the Green category (G_{l_s}). This concludes the enhanced clustering process of trains as part of the dynamic DRP deployment system.

7.4. Closing Remarks

This section provided a description of how the two original steps of the existing DRP set-up approach (discussed in subsection 2.3.3) are adapted to build an enhanced DRP set-up approach compatible with the system's general requirements.

The enhanced structure adheres to the existing DRP set-up approach and maintains the two-step process detailed in subsection 7.2. Nevertheless, both of these steps have been enhanced in order to support the dynamic deployment of the DRP operating concept. Additions to the original process have been discussed in detail throughout subsections 7.3.1 and 7.3.2. As a result, each step of the enhanced approach can be summarized as follows:

1. Enhanced identification and flagging of infrastructural elements: The DRP relevant infrastructural elements (i.e. first-order elements) of the chosen DRP are identified and flagged throughout the infrastructure model for every affected line in the network. Next, the second-order elements for every affected line are respectively identified. The enhanced processes recognize two approaches to identify second-order elements. One alternative is to rely on a pre-emptive or “off-line” identification of infrastructural elements with the potential to broaden the handling alternatives of trains during the deployment of the DRP operating concept. Another alternative is the “on-line” identification of infrastructural elements, supported by the features described in subsection 7.3.1, which can be selected in correspondence of the available computational effort.
2. Enhanced Clustering: All trains in the commuter railway network are clustered into one of five categories by contrasting their actual location in the network with the DRP relevant infrastructural elements following the decision tree depicted in figure 7.1.

The first step focuses on identifying and flagging relevant infrastructural elements throughout the disrupted network. The enhanced process facilitates the exploration of additional paths that have the potential to secure the transition of the affected lines to stable operations within the disruption. Overall, the enhanced process emulates the network’s examination of infrastructural elements by seasoned dispatchers. It does so by introducing a wider range of possible infrastructural elements (e.g. deviation points, routes or stations) to explore possible solutions in later modules. Furthermore, by filtering for the various characteristics of infrastructural elements, the identification and flagging procedure can be adapted, thereby maintaining general validity within different implementing conditions and allowing the overall approach to adapt to the limitations on the computational effort.

In the enhanced clustering process, the Green cluster is expanded upon to include the Green+ category to distinguish between unencumbered trains, which are driving toward (Green) and away from (Green +) the disruption. The Yellow cluster remains unchanged due to the complexity that would be involved in segregating this cluster into two categories and the minimal benefit this segregation stands to offer. The Red cluster falls in line with the system’s requirements, and like the Green cluster, it is split into the Red and Red+ categories. Red+ trains are those that may later be re-labelled as Yellow or Green following the time-out and highlighting the dynamicity of the approach.

Quantifying the exact time-out needed for every train in the Red+ category is very restricted due to the stochastic nature of the disrupted circumstances. Therefore, the manual inclusion of a time-out time in the system must be considered. Eventually, an approach for the handling of these trains would need to be introduced in later modules.

As discussed within the dynamic DRP deployment system’s overall approach (see subsections 3.5.2 and 3.5.3), with the set-up of the DRP operating concept concluded, the line-specific conflict identification and establishment of potential solution alternatives can now be conducted.

8. Line-Specific Conflict Identification and Establishment of Potential Solution Alternatives

8.1. Introduction

This section concentrates on the identification of line-specific conflicts based on the chosen line-specific DRP operating concept, as discussed in subsection 3.5.2 and 3.5.3. In overall, this module has as its main objectives the identification of the two line-specific conflict types (i.e. vehicle availability and reachability conflicts) within every affected line and the establishment of the most suitable means available to address them. This section provides a detail discussion on the establishment of an approach to conduct the identification of the line-specific conflicts and the establishment of potential solution alternatives, as foreseen by the general approach of the dynamic DRP deployment system.

At the outset, the DRP operating concepts provide adequate means to acquire an overview of the obstacles induced by a disruption, and that can only be handled by considering the management of assets of an entire line (see subsection 2.3.3). Unlike other disruption-management approaches, incorporating the line-specific DRP operating concepts permits to address the disruption with a top-down approach. By merging the available DRP operating concept for every affected line with the implementation of a CDCR approach onto the two operational levels (i.e. line-specific and vehicle-specific), as foreseen by the system's overall approach (see subsection 3.5.2 and 2.3.3), the foundation for much more comprehensive handling of trains during the disruption can be acquired.

As discussed in subsection 2.2.3, the identification of line-specific conflicts is the first step to be advanced in a heuristic CDCR process, which is set to identify, classify and sort the line-specific conflicts in a conflict list. Therefore, the identification of each of the line-specific conflict types should be based on the chosen DRP operating concept and complemented by the information about the specific disruption, both of which have been partially processed within the DRP set-up module (see section 7). Furthermore, as foreseen in subsection 3.5.2, the identified line-specific conflicts ought to be addressed through the implementation of predefined measure bundles established in subsection 6.4. As for any conflict identification process founded over predefined elemental conflict solution alternatives (see subsections 2.2.3), the classification of the identified conflicts would allow establishing the potential dispatching measures most compatible with the operational circumstances of each identified conflict.

Consequently, this module seeks to establish the groundwork for the identification of the line-specific conflicts and establishment of potential conflict solution alternatives for every affected line product of the classification of the identified conflicts. By doing so, the dynamic DRP deployment system would be able to narrow down specific handling measures for each of the trains in the network. For this purpose, the module relies on the input variables discussed in section 5, the set-up of the chosen DRP operating programs for the affected lines detailed in section 7 and the predefined elemental line-specific conflict solution alternatives as well as its bundles described in subsection 6.4.

In the following sections, the process supporting the line-specific conflict identification and the subsequent establishment of potential solution alternatives is derived with careful detail. Initially, subsection 8.2 establishes the determining variables which are required for the identification and classification of the line-specific conflicts. Later, subsection 8.3 establishes a structured approach to conduct the identification, classification, and sorting of both line-specific conflict types. Finally,

subsections 8.4 and 8.5 provide further detail regarding each of the processes detailed within the proposed structured approach.

8.2. Establishing the Determining Variables to Identify Line-Specific Conflicts

As discussed in subsection 3.7.2, line-specific conflicts cannot be isolated to individual trains and are constituted by two conflict types, namely, vehicle availability and reachability conflicts. Aligned with this module's objectives and the system's overall approach (see subsections 3.5.2 and 3.5.3 respectively), this subsection identifies and discusses the determining variables which are relevant for the identification and classification of line-specific conflicts.

For establishing the determining variables relevant for the identification of line-specific conflicts, this subsection concentrates separately on each of the line-specific conflict types.

On the one hand, as discussed in subsection 3.7.2, vehicle availability conflicts refer to either a surplus or lack of vehicles circulating in the network, in correspondence to the operating situation induced by the disruption and the DRP operating concept of an affected line. As discussed in subsection 5.3.1, the operating situation of an affected line induced by the disruption depends on the magnitude of the disruption and denotes the need to distinguish between specific sides. Three determining variables for identifying vehicle availability conflicts can be recognized, namely, the need to distinguish between different line sides, the number of trains available (i.e. circulating in the network), and the number of trains required to service the line-specific DRP operating concept considering the time of day (i.e. temporal category – see subsection 3.6.2). The last two listed determining variables are essential within the line-specific operational level since they support the stocktaking of vehicle resources and establish the already assessed number of trains needed to match the traffic with the disrupted capacity of the network (see subsection 2.3).

On the other hand, as discussed in subsection 3.7.2, reachability conflicts refer to all train services that began their service before the implementation of the dynamic DRP deployment system (i.e. $t_{0,TD}$), and due to either a complete blockage or their line's DRP operating concept, they cannot reach their originally planned end stations. As for vehicle availability conflicts, the disruption induced operating situation of a line also plays a key role in the identification of reachability conflicts. Therefore, two determining variables may be considered to identify reachability conflicts, namely, distinguishing between different line sides and establishing all trains circulating in the network that began their service before the implementation of the system (see subsection 5.4).

While establishing the determining variables for the identification of each of the line-specific conflicts entails a close consideration of each of the conflict types, establishing specific determining variables that support a classification of the identified conflicts would require introducing a much robust framework. A general overview regarding the classification of conflicts has been provided in subsection 2.3.3 and 3.6.2, where the spatiotemporal characteristics of the identified conflicts and the utilization of elemental conflict solution alternatives for their resolution are explained as significant alternatives to establish general classification criteria (Neuber 2017).

On the one hand, since line-specific conflicts affect an entire line and take place as soon as the DRP operating concept is being implemented, a classification solely based on spatiotemporal criteria would deliver a suboptimal classification approach. However, a solution-oriented classification may be easily supported through the already established bundles of conflict solution alternatives for line-specific conflicts (see subsection 6.4), which already consider specific characteristics of the line-specific conflict types (e.g. lack or surplus of vehicles). Furthermore, a

solution-oriented classification approach would directly support the ability of the module to establish potential conflict solution alternatives to address the identified conflicts, as discussed in subsection 8.1. As a result, employing a classification of conflicts mainly based on establishing potential conflict solution alternatives may constitute the most relevant approach.

As the classification of conflicts is foreseen to be based on the establishment of potential conflict solution alternatives, the determining variables should be derived by considering the solution prerequisites detailed in subsection 6.3 of each of the eight line-specific elemental conflict solutions listed in table 6.1. Focusing on the solution prerequisites of every elemental conflict solution within the line-specific operational level would allow establishing relevant determining variables based on two general aspects, namely, a measure's specific aim and the operating circumstances required for its implementation. Additionally, the structure of their respective bundles discussed in subsection 6.4 should also be taken into consideration, as they outline the potential implementation of each elemental conflict solution. The determining variables can be adeptly put in the context of the actual implementation of the considered measures by localizing them within their respective bundles as discussed for each line-specific conflict type discussed in subsection 6.4.

Figure 8.1 provides an overview of the relevant determining variables for the identification and classification of line-specific conflicts. A total of fifteen determining variables are presented and divided into direct and indirect determining variables. The term “direct” determining variable is utilized to denote the determining variables that must be considered for the identification of both line-specific conflict types. Correspondingly, the term “indirect” refers to the determining variables that ought to be considered for the classification of identified conflicts.

As a result, four direct determining variables have been established based on the discussion presented at the beginning of this subsection and eleven indirect determining variables are derived by considering the solution prerequisites detailed in subsection 6.3 and the structure of their respective bundles discussed in subsection 6.4.

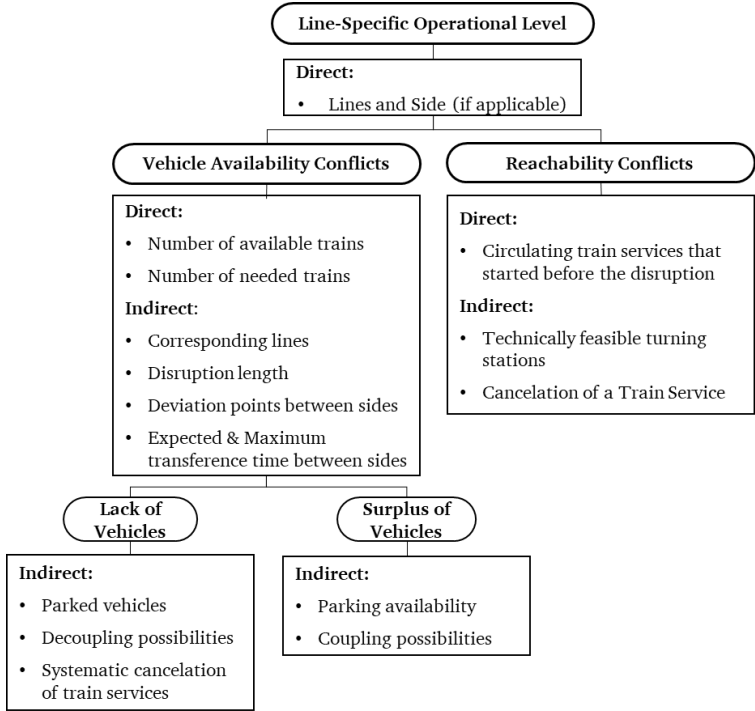

Figure 8.1 Relevant determining variables to be considered during their identification and classification of each of the line-specific conflict types (by author)

Nine of the eleven indirect determining variables displayed in figure 8.1 are listed under vehicle availability conflicts. Four of these nine determining variables derive from elemental conflict solution that may be utilized to address both a surplus and a lack of vehicle availability (i.e. ETL and TT) simultaneously. The four indirect determining variables are further described below:

- *Corresponding lines*: This determining variable establishes different possibilities for the handling of vehicle availability conflicts by linking the resources of two affected elements, as described in the elemental conflict solution measure.
- *Disruption length*: is particularly relevant when exploring the possibility of transferring trains between sides.
- *Deviation points between sides*: provides further complementary information on the ability to transfer trains between sides.
- *Expected & Maximum transfer time between sides*: As with the previous two determining variables, this also provides more information on the feasibility of transferring a train within the network.

The remaining five determining variables derive from elemental solution alternatives, which may be utilized to address either a lack (i.e. IET, CS and DCT) or a surplus (i.e. PT and CT) of vehicle availability. The five determining variables are further described below:

- *Parked vehicles*: This information, provides a detailed understanding of potential resources that can be used to address the conflicting circumstances across parking locations, broadening the overview of the disruption
- *Parking availability*: As with the previous determining variables, by analyzing the immediate availability of parking locations a much more comprehensive understanding of the actual situation across the network is secured
- *Coupling and decoupling possibilities*: These two determining variables take into account the possibility of balancing available vehicle resources with the assets already circulating in the network, expanding handling capabilities.
- *Systematic Cancellation of Train Services*: This determining variable reveals the need for a systematic removal of train services to match the lack of available trains with the operating concept.

Finally, the last two indirect determining variables displayed in figure 8.1, are listed under reachability conflicts. They derive, on the one hand, from an elemental conflict solution that may be exclusively utilized to solve this conflict type (i.e. ETT), and on the other hand, from the implementation of a CS on single train services. As such, the two indirect determining variables are further described below:

- *Technically feasible turning stations*: This determining variable explores the possibility of addressing reachability conflicts across the network independently from vehicle availability matters.
- *Cancellation of a train service*: While this determining variable and the systematic cancellation of train services (the final determining variable used for vehicle availability conflicts) are founded on the same elemental conflict solution alternative, their impact on the network is not the same. As part of reachability conflicts, the cancellation is conducted only for specific train services.

8.3. Structured Approach for the Identification and Classification Process

This subsection derived a general approach for conducting the identification and the classification of line-specific conflicts, which would, in turn, allow establishing the potential solution alternatives for addressing the identified conflicts. The identification and classification of the line-specific conflicts are framed within the handling of the determining variables detailed in subsection 8.2.

Currently, there are several approaches available to perform conflict identification, of which the most relevant have been discussed in subsection 2.3.3. Existing approaches are capable of evaluating the operational circumstances at a vehicle-specific level and identifying conflicts for a specific conflict type (e.g. occupancy, circulation, connection conflicts, etc.). However, this module strives for the identification of more than one conflict type across the assets of an entire line (see subsection 8.1). A new approach, which is compatible with the extent of the conflicts to be identified, must be derived.

In order to purposefully derive the required identification and classification approach to handle line-specific conflicts as part of the wider dynamic DRP deployment system, a review of the specific requirements across each of the network's relevant determining variables is first conducted in subsection 8.3.1. Once the requirements have been established, the overall module's structured approach is discussed in subsection 8.3.2.

8.3.1. Requirements for the Approach

The determining variables to be considered for the identification and classification of line-specific conflicts have already been described in subsection 8.2. Each of the established determining variables delivered clear requirements, which must be supported during the structuring of this module's approach.

As depicted in figure 8.1, the determining variables can be divided into three specific groups. An initial group that, if considered, supports the identification of both line-specific conflict types. Later, two different groups that concentrate on each of the line-specific conflict types, namely, vehicle availability and reachability conflicts and, if considered, would support the classification of the identified conflicts. The specific requirements are collected by observing the determining variables within each of these groups and then validated through a cross-check with the requirements and limitations of the dynamic DRP deployment system (see subsection 3.3.2 and 3.4.2).

General Requirements

At the general level, the identification process limits its scope to a line-specific level, considering entire lines as the objects of study (see subsection 3.5.2). Furthermore, depending on the magnitude of the disruption and the respective DRP operating concepts, the lines can be separated into two different sides. Thus, the identification process must not only consider entire lines but detail the handling of specific sides for these elements so that they are compatible with the disrupted operations and the line's DRP operating concept (see subsection 5.3.1).

By the same token, the identification of a broad range of conflicting circumstances across the affected lines and sides of the network entails the structuring of a robust framework capable of identifying and classifying several line-specific conflicts that may take place almost simultaneously. This requirement is further aligned with supporting this module's integration within a dynamic

DRP deployment system with general validity, which is, in turn, capable of managing disrupted operations within any network (see subsection 3.4.2).

Requirements for Identifying and Classifying Vehicle Availability Conflicts

For the identification and classification of vehicle availability conflicts, the approach must be framed around the consideration of the three direct determining variables established in subsection 8.2. Whereas one of the determining variables has already been considered within the general requirements (i.e. consideration of different sides for a line), the two remaining direct determining variables entail the number of available and the number of required trains. Thus, to identify the vehicle availability conflicts, the approach must be able to compare the number of available versus required trains within each specific affected lines and their respective sides.

Moreover, once the vehicle availability conflicts have been identified, the approach must support their classification as the means to identify potential solution alternatives from the predefined bundles of elemental conflict solution alternatives. At this point, the hierarchical structure introduced in subsection 6.4.1 becomes highly relevant. Therefore, the approach to classifying the identified vehicle availability conflicts should consider the nine indirect determining variables established in subsection 8.2 (e.g. existence of corresponding lines or parked vehicles) within the three-level hierarchical structure of the bundle of elemental conflict solution alternatives (see subsection 6.4.1 - figure 6.3).

Requirements for Identifying and Classifying Reachability Conflicts

As for vehicle availability conflicts, the approach for the identification and classification of reachability conflicts should consider the direct determining variable, namely, the train services that were circulating in the network before the disruption, and the two indirect determining variables that support their classification. However, as discussed in subsection 6.4.2, the ability to implement certain solution alternatives to address reachability conflicts is dependant on circumstances, which are identified during the classification of vehicle availability conflicts. Consequently, the identification and subsequent classification of reachability conflicts are subjected to the prior identification of vehicle availability conflicts.

8.3.2. Structured Approach

Now that the basic requirements for conducting the identification and classification of line-specific conflicts have been established, this subsection derives and describes the module's structured approach. The approach is based on existing conflict identification approaches implemented within CDCR processes intended for addressing vehicle-specific conflicts (see subsection 2.3.3).

As discussed in subsection 2.3.3, the underlying tasks within conflict identification as part of a CDCR process is the fulfillment of three central tasks:

- i)* conflict identification,
- ii)* classification,
- iii)* and sorting into a single conflict list.

The requirements discussed in subsection 8.3.1, provide with a solid foundation to establish the required identification and classification of each of the line-specific conflicts. However, the overall arrangement of the structured approach vis-à-vis the three underlying tasks must still be

established. The identification and classification process can be structured in a variety of ways., where three potential alternatives may be immediately considered:

1. Conducting the identification and classification simultaneously across both conflict types
2. First, conduct the identification and classification of vehicle availability conflicts and then proceed to reachability conflicts
3. First, conduct the identification and classification of reachability conflicts first and then proceed to vehicle availability conflicts

Each of the approaches constitutes a feasible alternative, however, two aspects must be taken into consideration. As discussed in subsection 8.2, the classification of line-specific conflicts is conducted by observing the potential conflict solution alternatives that can be implemented to solve the identified conflict. Additionally, as discussed throughout subsection 6.4, the implementation of the solutions is highly dependent on the existence of a surplus or a lack of vehicles (i.e. vehicle availability). Therefore, a much more effective approach may be established if vehicle availability conflicts are identified and classified before reachability conflicts, as established by the second above-introduced alternative.

The resulting structure of the line-specific conflict identification process, aligned with requirements and the three general conflict identification tasks is displayed in figure 8.2. The structure presented in figure 8.2 recognizes the operating situation of the affected lines and proceeds with the sequential identification, classification, and sorting of the line-specific conflicts.

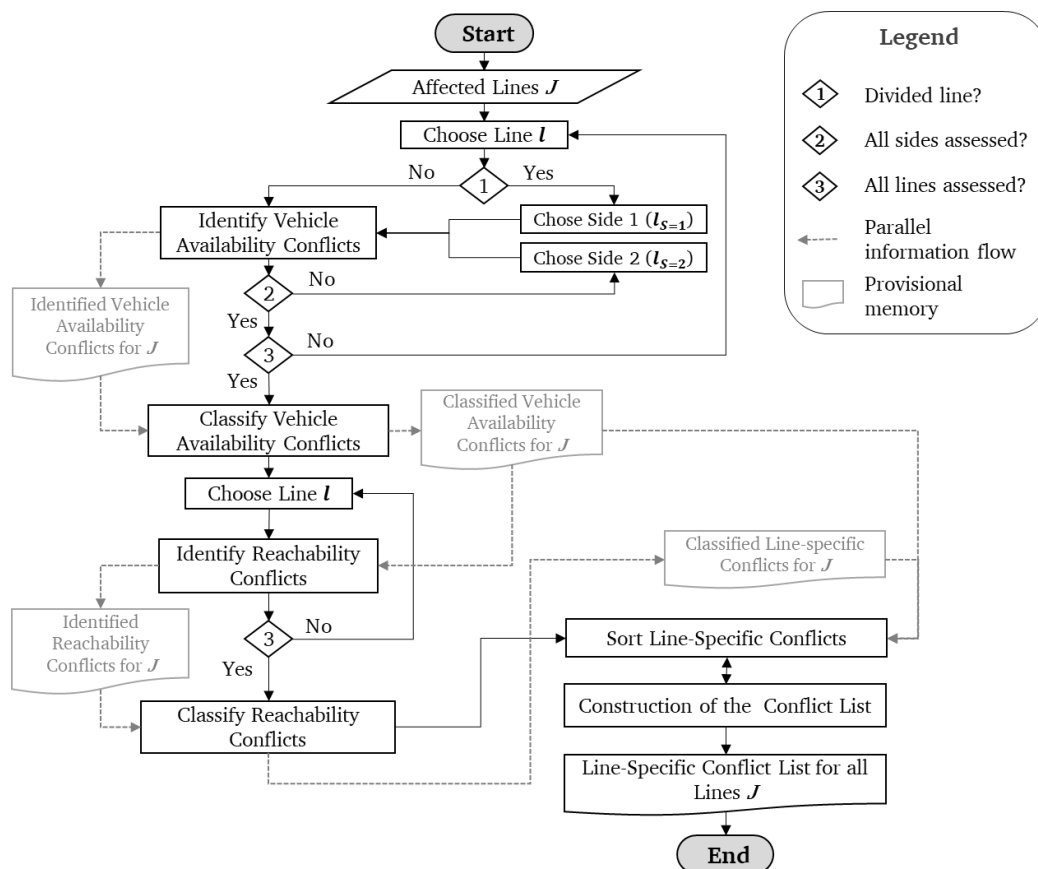

Figure 8.2 Structured approach for the identification, classification and sorting of line-specific conflicts (by author)

The identification, classification and sorting of the line-specific conflicts are conducted as detailed in figure 8.2. First, vehicle availability conflicts for all affected lines are identified. Once identified,

the vehicle availability conflicts are classified primarily based on solution-oriented criteria, which in this case, must respect the hierarchical structure of the elemental conflict solution bundle (see subsection 6.4). Later, the identification and classification processes are conducted in a similar way for reachability conflicts. However, in the case of reachability conflicts, the solution-oriented classification must come after the vehicle availability conflicts have already been classified as discussed in subsection 6.4.2. Ultimately, after conducting the identification and classification processes on every line and side, the conflicts are finally sorted within one single conflict list. The process regarding the sorting of the identified conflicts as the means to establish the line-specific conflict list still needs to be derived.

The processes within each of the four main conflict identification tasks featured in figure 8.2 are further detailed in the following subsections. Initially, in subsection 8.4, the identification and classification are presented in detail for each one of the line-specific conflict types. Thereafter, the process supporting the sorting and construction of the conflict list is derived and discussed in subsection 8.5.

8.4. Line-Specific Conflict Identification and Classification

This subsection presents the processes for conflict identification and classification across each of the line-specific conflict types. The following subsections provide a detailed account of the first four processes displayed in figure 8.2, namely, the identification as well as classification of vehicle availability and reachability conflicts, with special attention paid to the details of the operating situation of the affected lines and sides.

8.4.1. Objects of Study – Affected Lines and Sides

As discussed in subsection 5.3, a line l affected by the cause of the disruption may require differentiation between different sides l_s . This will also be reflected in its DRP operating concept and evidenced in the magnitude of the disruption (i.e. partial or complete blockage – see subsection 3.7.2). Such differentiation has been detailed in six different cases discussed in subsection 5.3.1. Therefore, all of the affected lines must have their respective l_s assigned in correspondence to the operating concept of the selected DRP. Nonetheless, it must be noted that if the line is not divided into different sides, the term S in l_s remains equal to 1.

8.4.2. Identification of Vehicle Availability Conflicts

The identification of vehicle availability conflicts is conducted through an appraisal of the two direct determining variables detailed in subsection 8.2. Together they are the only path towards ascertaining the actual nature of the vehicle availability conflicts (i.e. lack or surplus of trains) for the chosen line and side (if applicable).

The two direct determining variables, namely, the number of available and the number of required trains to service the operating program of a line, which has been modified by the chosen DRP operating concept, are examined separately for each selected line l on side l_s . Thereafter, once the numbers of required and available trains are known, the results are contrasted with each other so as to determine the existence of a conflict and, if so, its specific nature (i.e. be it a lack or a surplus of trains). All in all, the identification of vehicle availability consists of three general steps:

1. Ascertaining the number of available trains

2. Ascertaining the number of required trains to run the targeted DRP operating concept
3. Comparing the number available vs. required trains (i.e. conflict identification)

The three steps described above are repeated until all vehicle availability conflicts across all affected lines and sides l_s have been identified.

Number of Available Trains

To assess the number of available trains, its necessary to take stock of all the trains servicing the assessed line l_s plus those that can be immediately dispatched. This implies that the trains, which have been either directly or indirectly affected by the cause of the disruption, cannot be considered as available trains due to the uncertainty of their required “time-out” (see subsection 2.3.3 and Chu 2014). Therefore, regardless of them being included in the Red+ cluster of their lines, they cannot be considered as available trains (see subsection 7.3.2).

Information regarding the specific number of trains may be attained from the pre-assessed train categories provide prime data sources to achieve this purpose (see subsection 7.3). In essence, the number of available trains per line n_{A,l_s} can be discovered by adding the number of trains within Green G_{l_s} ; Green+ $G+l_s$; and Yellow Y_{l_s} categories running on the line l_s , as detailed below in equation 8.1.

$$n_{A,l_s} = n_{G_{l_s}} + n_{G+l_s} + n_{Y_{l_s}} \quad (8.1)$$

Number of Required Trains to Run the Targeted DRP Operating Concept

The number of required trains depends directly on the DRP operating concept of the assessed line l_s . As discussed in subsection 2.3.3, the DRP operating concept modifies the operating program of the affected lines, which results in the need to adjust the schedule (see subsection 3.4.2). There are existing approaches to derive the number of trains needed to service a line with a cyclic schedule, as the one discussed in subsection 2.2.1. Considering that the DRP operating concepts are built around the original cyclic schedule of the commuter railway lines, this approach can be utilized to derive the number of required trains without any major modification.

Equation 2.1, provides a relation to derive the required number of trains from a cyclic timetable by dividing the cycle time t_C with the service interval t_{SI} .

The cycle time t_C , as discussed in subsection 2.2.1, is equal to the time between two successive departures of the same train at a specific station. In its simplest of forms it can be understood as an addition of the: turning time at both end stations (t_{Turn,TS_x} ; t_{Turn,TS_y}) and the total journey time between these stations ($t_{f,x-y}$; $t_{f,y-x}$), which also includes any further operations within this period of time (e.g. stopping times, transition times, etc.). A relation to derive the cycle time is presented in equation 8.2.

$$t_C = t_{Turn,TS_x} + t_{f,TS_x-TS_y} + t_{Turn,TS_y} + t_{f,TS_y-TS_x} \quad (8.2)$$

As discussed in subsection 5.3.2, the DRP operating concept has already introduced general modifications to each of the affected line’s train services and their circulation plans. Once the specific changes in the operating program have been incorporated (i.e. cancellation of specific train services), it is possible to ascertain the resulting service interval for the line according to its DRP operating concept t_{SI,DRP,l_s} . In the same way, further modifications introduced in the line’s original

route (e.g. deviations, line divisions) according to the DRP operating concept should also be considered for ascertaining the line's cycle time $t_{C_{DRP,l_s}}$ within the DRP.

To support the general validity of the system (see subsection 3.4.2), it must be recognized that information about the DRP operating concept can be delivered in different granularities, as is typical for operating programs (see subsection 2.3.3). For example, an explicit account of the line's DRP service interval is not the same as information which only outlines the cancellation of certain train services in the line's original schedule. Therefore, the examination processes must be derived to cope with the most basic level of information and move towards defining the number of required trains.

In a typical cyclic schedule for commuter railway systems, if only the cancellation of specific train services is outlined in the DRP operating concept, the resulting service interval can be determined immediately. For example, if the DRP operating concept determines that at a particular time of day (e.g. HVZ) the service interval reinforcement must be cancelled; thus, the line would have as resulting service interval, the same service interval in which the line operates during the off-peak hours (see subsection 3.6.2). On the other hand, if the information is provided in terms of the targeted number of train services within a given period, namely, as a DRP frequency, the resulting service interval for the DRP can be ascertained as generalized in equation 8.3.

$$t_{SI,DRP,l_s} = \frac{60 \frac{min}{h}}{f_{DRP,l_s}} \quad (8.3)$$

Having identified the DRP service interval t_{SI,DRP,l_s} , the changes foreseen in the DRP operating concept must also be taken into consideration to derive the cycle time for the modified DRP routes. This is the case for turning times at the end as well as DRP turning stations and the journey times throughout the modified routes or deviations. All in all, the DRP cycle time $t_{C_{DRP,l_s}}$ can be ascertained as generalized in equation 8.4.

$$t_{C_{DRP,l_s}} = t_{Turn,TS_a,l_s} + t_{f,TS_a-TS_b,l_s} + t_{Turn,TS_b,l_s} + t_{f,TS_b-TS_a,l_s} \quad (8.4)$$

For the journey times t_{f,TS_a-TS_b,l_s} through different routes or deviations, the information can be derived from the infrastructural information respective to the model train (see subsection 5.1). Regarding the turning times t_{Turn,TS_a,l_s} at the end or DRP turning stations, the information available in the original schedule combined with the modifications introduced by the DRP operating concept in the operating program of the investigated line (per side if applicable), namely, any foreseen cancellation of train services, can be utilized. This would entail utilizing the difference between the scheduled departure and arrival times of two subsequent train services (i.e. supported in the DRP operating concept) from/at the end stations. The proposed approach is also applicable at the DRP turning stations, yet one aspect must be taken into consideration. The scheduled departure time of the train service from the DRP turning station foresaw in the schedule should be chosen such that the turn delivers a positive turn (also respecting the minimum turning time – see subsection 3.6.2) when combined with the arrival time of the incoming train service to the station (see subsection 3.6.2). This is because the positive turn would guarantee that stable operations during the disruption are being analyzed.

Ultimately, the number of trains required to run the DRP operating concept n_{R,DRP,l_s} can be calculated by dividing the DRP cycle time $t_{C_{DRP,l_s}}$ by DRP service interval t_{SI,DRP,l_s} . The calculation

of the number of trains is outlined in equation 8.5, where the resulting number is rounded up to the nearest integer.

$$n_{R,DRP,l_S} = \left\lceil \frac{t_{C,DRP,l_S}}{t_{SI,DRP,l_S}} \right\rceil \quad (8.5)$$

Besides, more than one cycle variant may exist for the affected line within the DRP operating concept. Stemer (2018) proposes two modifications to equation 8.5 to derive the number of trains required to service the DRP operating concept for a line with cycle variants.

The first modification assumes that trains are allowed to switch between the different cycle variants ψ within the same line l_S (see subsection 2.2.1). Acknowledging the existence of cycle variants affects the number of trains required for the line. Thus, to support a train's capability to exchange cycle variants, the necessary modifications are presented in equation 8.6.

$$n_{R,DRP,l_S} = \left\lceil \sum_{\psi=1}^{\psi} \frac{t_{C,DRP,l_S,\psi}}{t_{SI,DRP,l_S,\psi}} \right\rceil \quad (8.6)$$

The second modification assumes that trains can be restrained from changing between cycle variants. Equation 8.7 introduces the necessary modifications to ascertain the required number of trains in cases where there is a limited capability to switch between cycle variants.

$$n_{R,DRP,l_S} = \sum_{\psi=1}^{\psi} \left\lceil \frac{t_{C,DRP,l_S,\psi}}{t_{SI,DRP,l_S,\psi}} \right\rceil \quad (8.7)$$

Finally, for lines which are physically separated between sides and the DRP operating concept foresees the total cancellation of the operations on one side, the number of required trains on the cancelled side is equal to zero; thus $n_{R,DRP,l_S} = 0$.

Conflict Identification

The final step in the process of identifying the vehicle availability conflict of a given line l_S implies a simple comparison between the number of available n_{A,l_S} and the number of required n_{R,l_S} trains to run the DRP operating concept. This final comparison reveals the specific characteristic of the examined conflict (i.e. the lack or surplus of trains).

This final process is done by subtracting the number of required trains from the number of available trains, which results in the number of conflicting trains n_{C,l_S} for line l_S , as generalized in equation 8.8.

$$n_{C,l_S} = n_{A,l_S} - n_{R,DRP,l_S} \quad (8.8)$$

- If n_{C,l_S} results in a positive integer, line l_S has a surplus of trains.
- If n_{C,l_S} results in a negative integer, then line l_S has a lack of trains.
- If n_{C,l_S} is equal to zero the line l_S is free of vehicle availability conflicts.

8.4.3. Classification of Vehicle Availability Conflicts

The identification of vehicle availability conflicts is complemented by considering the nine indirect determining variables detailed in subsection 8.2. The examination of these determining variables

is framed within the hierarchical structure of the bundle of elemental conflict solution alternatives for vehicle availability conflicts, as discussed in subsection 8.3.1, ultimately leading to a solution-oriented classification of the conflicts.

Having already identified the vehicle availability conflicts for the affected lines L within each of its sides l_s , the systematic classification based on the relevant indirect determining variables can be carried out. The classification is performed for each affected line l_s until all the conflicts have been classified, as depicted in figure 8.2. Ultimately, the classification of the vehicle availability conflicts of an investigated line permits to determine the best fitting solution alternatives among the respective bundle of predefined elemental conflict solution alternatives (see subsection 6.5).

As with the identification process, the classification process can start with any affected line l and side l_s . However, it should be noted that a lack of trains is the most challenging situation to handle during operations (see subsection 6.4). Besides, considering the available measures, once a deficit is discovered, it provides with the means to address the conflicting circumstances of lines with a surplus of trains. Therefore, for practical purposes and to achieve a more comprehensive classification of vehicle availability conflicts, lines with a lack of trains are investigated first.

As discussed in subsection 8.2, since every single one of the nine indirect determining variables is inherently linked to an elemental conflict solution alternative, the bundle's hierarchical structure of conflict solution alternatives can be directly integrated into the classification process (see figure 6.3). As a result, depending on the nature of the conflict ($n_{c,l_s} < 0 \vee n_{c,l_s} > 0$) of an investigated line l_s , the classification progresses along the corresponding branch in the hierarchical structure (i.e. lack or surplus of trains) while focusing on the relevant solution alternatives for the identified conflict n_{c,l_s} at each level. All the determining variables regarding the contemplated solution alternatives of the assessed level must be considered. The classification of an investigated line l_s only concludes when all the conflicting train resources have been accounted for.

Furthermore, the classification requires a scheme or structure that captures the character of the considered determining variables. While a scheme can be immediately derived from the already established hierarchical structure of the bundle of conflict solution alternatives, a classification framework is still imperative.

At this stage, an alternative classification scheme that directly reflects the determining variables must be introduced. This scheme should be aligned with the module's requirements (see subsection 8.3.1.) and overall structure (see subsection 8.3.2). The assessment of the indirect determining variables across both of these branches is described in detail in the following subtitle.

Classification Scheme

To support the classification of the nine determining variables, a total of forty-one different underlying classes of vehicle availability conflicts may be recognized.

The coding of the identified conflicts is divided into two sections, as displayed by the example depicted in figure 8.3. The initial section of the code highlights the conflict type and the operational condition of the investigated line. In the example depicted in figure 8.3, the first section of the code corresponds to a vehicle availability conflict that affects a line with only one side and has a surplus of trains. The second section details all relevant elemental conflict solution alternatives, which account for all the conflicting vehicle resources. The second section of the code relies on the abbreviations introduced to recognize the predefined elemental conflict solution alternatives in

subsection 6.4. In the example, the assessment of the determining variables has established that all conflicting trains can be dealt with through an exchange of trains between corresponding lines (ETL) and a removal of trains from the existing parking location (PT).

Ultimately, this classification structure is imposed on the already identified conflicts n_{c,l_s} across all affected lines.

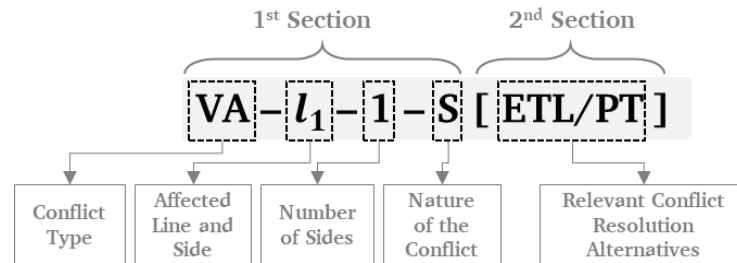

Figure 8.3 Coding utilized for the classification process of every identified vehicle availability conflict (by author)

Classification Process for a Lack of Vehicles ($n_{c,l_s} < 0$)

In case the investigated line l_s has a lack of trains, the relevant branch of the hierarchal structure in the elemental conflict solution bundle is presented in figure 8.4. The branch is constituted by five elemental conflict solution alternatives across three levels and includes seven of the nine indirect relevant determining variables detailed in subsection 8.2. The first portion of the classification code for the investigated line l_s can already be established: (VA- l_s -S-L[]).

The evaluation of the respective determining variables for an identified conflict n_{c,l_s} in an investigated line l_s , identifies a lack of trains as the line's vehicle availability conflict. The classification based on the determining variables is conducted systematically across the three hierarchical levels in concordance with the elemental conflict solution measures that constitute each level (see figure 8.4). The classification progresses across the different levels until all lacking trains have been accounted for.

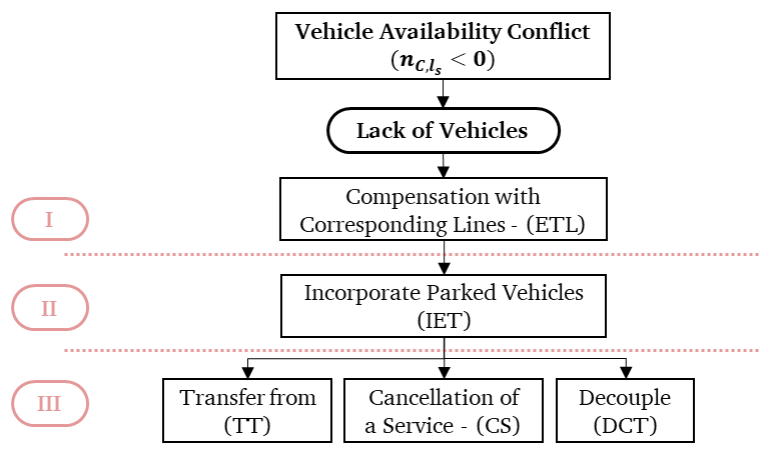

Figure 8.4 Hierarchy of elemental conflicts solution alternatives for a lack of vehicle availability (by author)

Table 8.1 Solution-oriented classification scheme for vehicle availability conflicts with a lack of trains (by author)

				Classification	N°							
				(VA- l_s -S-L [ETL])	1							
Lack of Vehicles	Possible	Compensation by an Exchange of Trains Between Corresponding Lines	Complete compensation by exchange with corresponding lines		(VA- l_s -S-L [ETL])	1						
			Possible	Compensation with parked trains	Complete compensation with parked trains		(VA- l_s -S-L [ETL/IET])	2				
					Possible	Compensation through a Transfer	Possible	Possible decoupling of trains; Possible cancellation of Services	(VA- l_s -S-L [ETL/IET/TT/DCT/CS])	3		
							Impossible	Impossible decoupling of trains; Possible cancellation of Services	(VA- l_s -S-L [ETL/IET/TT/CS])	4		
					Impossible	Compensation through a Transfer	Possible	Possible decoupling of trains; Possible cancellation of Services	(VA- l_s -S-L [ETL/IET/DCT/CS])	5		
							Impossible	Impossible decoupling of trains; Cancellation of Services imminent	(VA- l_s -S-L [ETL/IET/CS])	6		
					Impossible	Compensation through a Transfer	Possible	Possible	Possible decoupling of trains; Possible cancellation of Services	(VA- l_s -S-L [ETL/TT/DCT/CS])	7	
			Impossible	Impossible decoupling of trains; Possible cancellation of Services				(VA- l_s -S-L [ETL/TT/CS])	8			
			Impossible	Possible			Possible decoupling of trains; Possible cancellation of Services	(VA- l_s -S-L [ETL/DCT/CS])	9			
				Impossible			Impossible decoupling of trains; Cancellation of Services imminent	(VA- l_s -S-L [ETL/CS])	10			
	Impossible	Compensation by an Exchange of Trains Between Corresponding Lines	Compensation with parked trains	Complete Compensation with parked trains		(VA- l_s -S-L [IET])	11					
				Possible	Compensation through a Transfer	Possible	Possible	Possible decoupling of trains; Possible cancellation of Services	(VA- l_s -S-L [IET/TT/DCT/CS])	12		
							Impossible	Impossible decoupling of trains; Possible cancellation of Services	(VA- l_s -S-L [IET/TT/CS])	13		
						Impossible	Compensation through a Transfer	Possible	Possible decoupling of trains; Possible cancellation of Services	(VA- l_s -S-L [IET/DCT/CS])	14	
								Impossible	Impossible decoupling of trains; Cancellation of Services imminent	(VA- l_s -S-L [IET/CS])	15	
						Impossible	Compensation through a Transfer	Possible	Possible	Possible decoupling of trains; Possible cancellation of Services	(VA- l_s -S-L [TT/DCT/CS])	16
									Impossible	Impossible decoupling of trains; Possible cancellation of Services	(VA- l_s -S-L [TT/CS])	17
				Impossible	Possible			Possible decoupling of trains; Possible cancellation of Services	(VA- l_s -S-L [DCT/CS])	18		
							Impossible	Impossible decoupling of trains; Cancellation of Services imminent	(VA- l_s -S-L [CS])	19		

Once the classification process corroborates that all conflicting vehicles have been accounted for at the specific level, the conflict class is appointed as detailed by the previously explained scheme. The appointing of the specific class completes the second portion of the code (VA- l_s -S-L[___]), resulting in one of the nineteen possibilities as detailed in table 8.1.

Following the hierarchical hierarchy of elemental conflicts solution alternatives displayed in figure 8.4, the classification process is further detailed and divided into three general levels.

- At the outset, to account for the lack of trains in the identified vehicle availability conflict n_{C,l_s} , the availability of resources across the corresponding lines is evaluated. The potential exchange of trains between lines is considered in four steps:
 - First, it is necessary to check if the affected line l has at least one corresponding line l^c , and if there is any overlap or connection between their routes on the

investigated side. If no corresponding lines have been identified or if their routes do not overlap/connect at any point across the investigated side, the next step in the hierarchy must be explored.

- Second, if a corresponding line for the investigated side l_s^c is identified, the nature of the vehicle availability conflict must be determined. If the corresponding line l_s^c also has a lack of trains, the next corresponding line must be investigated. If all corresponding lines have a verified lack of trains, the next level in the hierarchy must be explored.
- Third, for every corresponding line l_s^c with a surplus of trains, the number of trains n_{C,l_s^c} that can be exchanged is compared with the number of required trains for the line being investigated, as in equation 8.9.

$$n_{C,l_s} + n_{C,l_s^c} = n'_{C,l_s} \quad (8.9)$$

- Fourth, if the resulting number of trains for the investigated line n'_{C,l_s} is equal to or higher than zero (i.e. $n'_{C,l_s} \geq 0$), the vehicle availability conflict for line l_s can be solved completely through a compensation by an exchange of trains between corresponding lines. Thus, the conflict can be classified as (VA- l_s -S-L/ETL). If this is not the case, the next level in the hierarchy must be explored.
2. If there exist vehicle compositions with service availability (see subsections 6.3.2 and 3.6.2), an introduction of parked vehicles into the network may be used to resolve the remaining vehicle availability conflicts n'_{C,l_s} . This is evaluated in three steps:

- First, an exploration of all service available vehicle compositions is conducted across the parking locations along the route of the investigated line l_s . If there are no service available vehicle compositions, the next level in the hierarchy must be explored.
- Second, the actual vehicle compositions of the identified service available vehicles are compared with that required for the train services of the investigated line l_s at the deployment time of day $t_{0,TD}$. Here, the number of service available vehicles must be differentiated between vehicle compositions that fit the requirements of the train services in the original schedule n_{P,l_s} , and vehicles or vehicle compositions incompatible with the requirements of the train services in the original schedule n_{P,U,l_s} . The use of vehicle compositions with fewer units than required must be carefully considered bearing in mind the actual disrupted circumstances in the commuter railway network, particularly during peak hours $t_{0,HVZ}$ due to high passenger flows. The number of service available vehicle compositions must be compared with the number of trains still required, as in equation 8.10.

$$n'_{C,l_s} + n_{P,l_s} + n_{P,U,l_s} = n''_{C,l_s} \quad (8.10)$$

- Third, if the resulting number of required trains for the investigated line n''_{C,l_s} is equal to or higher than zero (i.e. $n''_{C,l_s} \geq 0$), the vehicle availability conflict for line l_s can be solved completely through the incorporation of parked vehicles and classified either as (VA- l_s -S-L/IET). This is also true if trains from corresponding lines can help to address the deficit, although this may only partially solve the conflict (VA- l_s -S-L/ETL/IET). If the result is lower than zero, the next level in the hierarchy must be explored.

3. The third level contemplates the appraisal of the six determining variables distributed across three elemental conflict solution alternatives (see figure 6.3). It must be noted that since all the three alternatives stand at the same hierarchical level, the classification depends on the possible implementation of each specific alternative and the extent (i.e. reduction of the initial lack of vehicles) to which the conflict has been addressed in the previous two levels. Therefore, all relevant determining variables of the remaining solution alternatives are evaluated, and the conflict is only classified at the end.

Three of the six determining variables relate to the transfer of trains between sides. At the outset, the capacity to transfer trains from the opposite side of the investigated line is explored in seven steps to resolve the vehicle availability conflict n''_{c,l_s} :

- First, it is necessary to check if the investigated line $l_{s=1}$ is divided into two different sides (i.e. $l_{s=2}, \exists$), and if the opposite side has an excess number of trains (i.e. $n_{c,l_{s=2}} > 0$) that can be transferred. If there is no opposite side for the investigated line or if it does not have an excess of trains, the next solution alternative must be explored.
- Second, an exploration of the available deviation points between sides is conducted, considering the second-order deviation points detailed in subsection 7.3.1. If there are no second-order deviation points that can be identified, the next solution alternative must be explored.
- Third, an approximate transfer time between side $l_{s=2}$ and $l_{s=1}$ must be established. The transfer time between sides is maintained at a line-specific level and extracted from the infrastructure information equal to the journey time for the respective model train across the acknowledged deviation routes (as discussed in subsection 6.3.4). If there is more than one deviation route, all alternatives must be considered. The journey time across one alternative is computed from the deviation point at the origin side $l_{s=2}$ to the line's end station on the opposite side $l_{s=1}$. If there is more than one cycle variant for the line $l_{s=1}$ (see subsection 3.6.2), the end station that generates the minimum journey time will be selected. Finally, the deviation alternative with the overall minimum journey time is designated as the approximate transfer time between sides $t_{trans,l_{s=2}-l_{s=1}}$.
- Fourth, it is necessary to establish a maximum transfer time between sides $\max t_{trans,l_{s=2}-l_{s=1}}$. As discussed in subsection 6.3.4, there is no clear method for establishing the maximum transfer time. However, Stemer (2018) indicates the importance of ensuring the practical integrity of the transfer as a solution alternative and (guided by current practices) suggests that a transferred train should be able to complete at least one service on the opposite side before the disruption ends. Therefore, the maximum transfer time can be calculated as in equation 8.11.

$$\max t_{trans,l_{s=2}-l_{s=1}} = t_{EDL} - \frac{t_{C_{DRP},l_{s=1}}}{2} \quad (8.11)$$

The only exception is for the affected line's end-of-day operations (see subsection 3.7.2). In this case, the interval between the system's deployment time $t_{0,TD}$ and the line's end-of-day operations is compared with the estimated disruption length (t_{EDL}) and the lowest value is included in equation 18.11.

- Fifth, having identified the approximate and maximum transfer times, these values must be contrasted with one another, as in equation 8.12.

$$t_{trans,l_{S=2}-l_{S=1}} \leq t_{trans,max,l_{S=2}-l_{S=1}} \quad (8.12)$$

If the approximate transfer time $t_{trans,l_{S=2}-l_{S=1}}$ is less than or equal to the maximum transfer time $t_{trans,max,l_{S=2}-l_{S=1}}$, the transfer can be carried out successfully. If it exceeds the maximum, the next solution alternative must be explored.

- Sixth, if transfer time permits, the maximum number of trains that can be transferred $n_{F,l_{S=2}}$ from the opposite side $l_{S=2}$ must be compared with the number of required trains for the investigated conflict, as in equation 8.13. The maximum number of trains that can be transferred is equal to the number of additional trains the line currently has circulating in the network and that are driving towards a possible deviation point.

$$n''_{c,l_s} + n_{F,l_{S=2}} = n'''_{c,l_s} \quad (8.13)$$

- Seventh, if the resulting number of required trains for the investigated line n'''_{c,l_s} is equal to or higher than zero (i.e. $n'''_{c,l_s} \geq 0$), the vehicle availability conflict for line l_s can be solved completely through a transfer of vehicles between sides, making the TT an available option. However, regardless of the result, the next solution alternative must be explored.

As appreciated in figure 6.3, there are still two remaining solution alternatives and determining variables for the remaining number of required trains. The possible decoupling of existing trains is evaluated next. However, if the network does not have the necessary operational foundation to handle the coupling or decoupling of trains, as discussed in subsection 6.3.7, this determining variable can be left aside. In this case, the last available option to deal with the lack of vehicle resources for the investigated line l_s would be the systematic cancellation of train services.

Nonetheless, as part of the system's standard approach, the coupling and decoupling of trains must be evaluated. Therefore, in case the decoupling of trains can be supported by the implementing context, it is evaluated in three steps:

- First, all the trains that circulate in the network and provide services to line l_s are organized in sequential order, beginning with those with the greatest number of units in their vehicle composition and that are staffed with enough crew members (as discussed in 6.3.7). Since decoupling would most certainly derive vehicle compositions which are not compatible with the vehicle composition originally planned for the respective train service, this must be carefully considered in correspondence with the foresaw network's demand in respect to the actual time of day (i.e. $t_{0,TD}$). The utilization of trains with fewer vehicles in their composition must be carefully considered during peak hours (i.e. $t_{0,HVZ}$) due to the existence of stronger demand. If generating unfitting vehicle compositions is not contemplated as an option or if additional personnel cannot be provided, the final solution alternative must be evaluated.
- Second, if unfitting vehicle compositions stand as a plausible option, the number of vehicle compositions gained by decoupling is established. The exploration follows the sequential order laid out in the first step and observes the inherent limitations imposed by the DRP operating concept on train services and circulation

plans. For example, vehicle compositions that must be decoupled as part of their circulation plan cannot be left with only one unit, as this would result in the cancellation of another train service. Hence, if possible decoupling vehicle compositions n_{DC,U,l_s} are identified among the examined vehicle compositions; they must be compared with the number of required trains for the investigated conflict, as in equation 8.14.

$$n''_{C,l_s} + n_{DC,U,l_s} = n'''_{C,l_s} \quad (8.14)$$

- Third, if the resulting number of required trains for the investigated line n'''_{C,l_s} is equal to or greater than zero (i.e. $n'''_{C,l_s} \geq 0$), the vehicle availability conflict for line l_s can be solved through a decoupling of its trains (i.e. DCT). However, regardless of the result, the next solution alternative must be explored.

The last elemental conflict solution alternative at this level, namely, the cancellation of train services, stands as the ultimate possible instance to account for the required vehicles. Since this last alternative can always be implemented, evaluating its applicability requires establishing its role in combination with the other two already assessed conflict solution alternatives. Ultimately, four possibilities may be contemplated:

- i) If both transfer and decoupling are feasible, and individually they cannot help to reduce the number of required trains ($n_{F,l_{S_2}} < |n''_{C,l_s}| \wedge n_{DC,U,l_s} < |n''_{C,l_s}|$), their combination is explored and compared with the number of still required trains n''_{C,l_s} , as in equation 8.15.

$$n''_{C,l_s} + n_{F,l_{S_2}} + n_{DC,U,l_s} = n'''_{C,l_s} \quad (8.15)$$

If the resulting number of required trains for the investigated line n'''_{C,l_s} is equal to or greater than zero (i.e. $n'''_{C,l_s} \geq 0$), the vehicle availability conflict for line l_s can be solved through a combination of decoupling and transfer of trains. Nonetheless, the systematic cancellation of services is always included within the combination. In this case, and depending on the already assessed operational circumstances in the previous levels, the conflict can be classified as indicated in table 8.1 in one of the conflict classes respective to the numbers: 3, 7, 12, 16.

- ii) If the decoupling of trains is not an available measure for the considered commuter railway network or there are no trains servicing the investigated line that can be decoupled, the number of still required trains n''_{C,l_s} can only be addressed through a transfer of trains or a systematic cancellation of train services. In this case and depending on the already assessed operational circumstances in the previous levels, the conflict can be classified as indicated in table 8.1 by the conflict class respective to the numbers: 4, 8, 13, 17.
- iii) If the transfer of trains is not an available measure for the investigated line and/or the conflict n''_{C,l_s} can only be addressed through a decoupling of trains or a systematic cancellation of train services, the conflict can be classified as indicated in table 8.1 by one of the conflict classes respective to the numbers: 5, 9, 14, 18 (depending on the already assessed operational circumstances at previous levels).
- iv) Finally, if neither a transfer nor a decoupling of trains is a plausible alternative and the conflict n''_{C,l_s} can only be solved through a systematic cancellation of train services so as to make the DRP operating concept compatible with the vehicle availability, the conflict can be classified as indicated in table 8.1 by the conflict

class respective to the numbers: 6, 10, 15, 19 (again depending on the already assessed operational circumstances at previous levels).

This marks the end of the appraisal of the indirect determining variables for the classification of the vehicle availability conflicts with a lack of trains.

Classification Process for a Surplus of Vehicles ($n_{c,l_s} > 0$)

In cases when the investigated line l_s has a surplus of trains, the relevant branch on the hierarchical structure of the bundle is presented in figure 8.5. The branch is constituted by three elemental conflict solution alternatives across three levels and one alternative, which is dependent on the conflicting situation at the opposite side of the line (if applicable). The classification process considers three of the nine indirect relevant determining variables detailed in subsection 8.2. The first portion of the classification code for the investigated line l_s can already be established: (VA- l_s -S-S [_]).

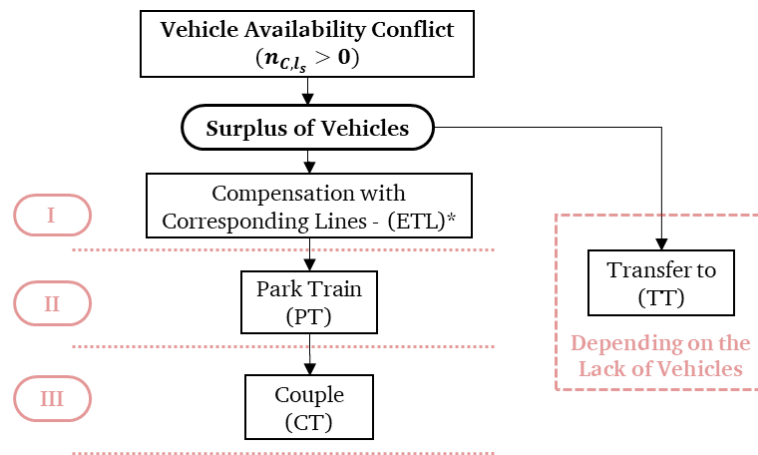

Figure 8.5 Hierarchy of elemental conflicts solution alternatives for a surplus of vehicle availability (by author)

Table 8.2 Solution-oriented classification scheme for vehicle availability conflicts with a surplus of trains (by author)

Surplus of Vehicles		Compensation by an Exchange of Trains Between Corresponding Lines		Classification		N°	
Possible	Dependency on the opposite side	Dependent	Compensation w. parking Locations	Complete compensation by an exchange between corresponding lines		(VA- l_s -S-S [ETL/TT])	20
				Possible	Complete Compensation with Conventional parking locations	(VA- l_s -S-S [ETL/TT/PT])	21
					Possible coupling of trains; Compensation with unconventional parking locations	(VA- l_s -S-S [ETL/TT/PT/CT/PT _U])	22
					Impossible coupling of trains; Compensation with unconventional parking locations	(VA- l_s -S-S [ETL/TT/PT/PT _U])	23
					Possible coupling of trains; Compensation with unconventional parking locations	(VA- l_s -S-S [ETL/TT/CT/PT _U])	24
		Impossible coupling of trains; Compensation with unconventional parking locations	(VA- l_s -S-S [ETL/TT/PT _U])	25			
		Independent	Compensation w. parking Locations	Complete compensation with corresponding lines		(VA- l_s -S-S [ETL])	26
				Possible	Complete Compensation with Conventional parking locations	(VA- l_s -S-S [ETL/PT])	27
					Possible coupling of trains; Compensation with unconventional parking locations	(VA- l_s -S-S [ETL/PT/CT/PT _U])	28
					Impossible coupling of trains; Compensation with unconventional parking locations	(VA- l_s -S-S [ETL/PT _U])	29
	Possible coupling of trains; Compensation with unconventional parking locations				(VA- l_s -S-S [ETL/CT/PT _U])	30	
	Impossible coupling of trains; Compensation with unconventional parking locations	(VA- l_s -S-S [ETL/PT _U])	31				
	Impossible	Dependency on the opposite side	Dependent	Compensation w. parking Locations	Complete Compensation with Conventional parking locations	(VA- l_s -S-S [TT/PT])	32
					Possible coupling of trains; Compensation with unconventional parking locations	(VA- l_s -S-S [TT/PT/CT/PT _U])	33
					Impossible coupling of trains; Compensation with unconventional parking locations	(VA- l_s -S-S [TT/PT/PT _U])	34
					Possible coupling of trains; Compensation with unconventional parking locations	(VA- l_s -S-S [TT/CT/PT _U])	35
					Impossible coupling of trains; Compensation with unconventional parking locations	(VA- l_s -S-S [TT/PT _U])	36
		Independent	Compensation w. parking Locations	Possible	Complete Compensation with Conventional parking locations	(VA- l_s -S-S [PT])	37
					Possible coupling of trains; Compensation with unconventional parking locations	(VA- l_s -S-S [PT/CT/PT _U])	38
					Impossible coupling of trains; Compensation with unconventional parking locations	(VA- l_s -S-S [PT/PT _U])	39
					Possible coupling of trains; Compensation with unconventional parking locations	(VA- l_s -S-S [CT/PT _U])	40
Impossible coupling of trains; Compensation with unconventional parking locations					(VA- l_s -S-S [PT _U])	41	

The classification based on the determining variables is conducted systematically across the three hierarchical levels in accordance with the elemental conflict solution measures at each level (see figure 8.5). The classification process accounts for the surplus of n_{c,l_s} trains of an investigated line l_s , identified as the line's vehicle availability conflict. The classification progresses through the different levels in the hierarchy until all surplus trains have been accounted for.

Once the evaluation of the relevant determining variables at the specific level corroborates that all conflicting vehicles have been accounted for, the conflict class can be appointed, as per the scheme detailed at the beginning of this section. The conflict class complements the second portion of the code (VA- l_s -S-S [_]) resulting in one of the twenty-one possibilities, as detailed in table 8.2.

The classification process, which is based on the consideration of the established determining variables, matches the three hierarchical levels, as displayed in figure 8.5. However, in this case,

transferring trains as determined by the opposite side of the investigated line l_s must also be taken into consideration.

0. To begin, information regarding the transfer of trains as established on the affected line's opposite side l_{s_2} , is incorporated. The exploration is only conducted if l_{s_2} has demonstrated the need and ability to transfer trains between sides. The number of required trains on the opposite side $n''_{c,l_{s_2}}$ is compared with the maximum number of trains that can be transferred n_{F,l_s} , as in equation 18.16. As discussed in the previous subtitle, only trains which are immediately driving towards the deviation points can be considered for this end.

$$n''_{c,l_{s_2}} + n_{F,l_s} = n'_{c,l_s} \quad (8.16)$$

1. As with the lack of trains, the availability of trains must also be evaluated in the corresponding lines. In principle, the evaluation follows the same structure as detailed for the lack of trains; however, steps two through four should be modified as follows:
 - Second, if the corresponding line(s) l_s^c have a surplus of trains, the next level in the hierarchy must be explored.
 - Third, if the corresponding line(s) l_s^c have a lack of trains, the number of trains is compared with the number of surplus trains on the investigated line l_s as in equation 8.9 for every corresponding line with a lack of trains.
 - Fourth, if the resulting number of surplus trains on the investigated line (n'_{c,l_s}) is equal to or less than zero, the vehicle availability conflict for line l_s can be solved completely by exchanging trains between corresponding lines, and classified as (VA- l_s -S-S [ETL]) or when the line has demonstrated the need and ability for a transfer as (VA- l_s -S-S [ETL/TT]). If this is not the case, the next level in the hierarchy must be explored.

Before evaluating the next level, it must be noted that the number of trains ascertained at the end of this first level cannot be determined with precision. At this point in the evaluation, the number of trains to be transferred cannot be precisely established since on the opposite side l_{s_2} of the investigated line, this alternative solution is grouped with two other possibilities at the same level. Therefore, in order to ensure that the widest arrange of possible solutions is being considered, the following levels are evaluated by considering the least favourable circumstances. Thus, the value for n'_{c,l_s} is made equal to the number of trains that can be exchanged between corresponding lines, as in equation 8.9.

2. The availability of parking locations (see subsection 5.1.2) that can be utilized for the removal and parking of trains outside of the network to resolve the remaining surplus of trains n'_{c,l_s} is evaluated in four steps:
 - First, an exploration of all conventional parking locations immediately accessible along the route of the investigated line l_s is conducted (see subsection 3.7.2). As discussed in subsection 6.3.3 and subsection 3.7.2, this includes the parking locations frequently utilized by vehicles of the line (e.g. at end stations), parking locations detailed in the DRP operating concept of the line and side (if available), and all parking locations within the commuter railway network that can be accessed along the line's route from both driving directions without any deviation. If no parking locations are available, the evaluation advances directly to step four.
 - Second, the available parking length (or number of vehicle compositions) throughout the identified parking locations is compared with that required by the

vehicle compositions of the investigated line l_s , which are to be removed from the network. The maximum number of vehicle compositions that can be parked throughout the different parking locations n_{E,l_s} must be compared with the number of conflicting trains in the investigated conflict, as in equation 8.17.

$$n'_{C,l_s} - n_{E,l_s} = n''_{C,l_s} \quad (8.17)$$

- Third, if the resulting number of surplus trains for the investigated line n''_{C,l_s} is equal to or less than zero (i.e. $n''_{C,l_s} \leq 0$), the vehicle availability conflict for line l_s can be entirely solved through the removal of trains from the network, and classified as indicated in table 8.2 in the class respective to the numbers: 21, 27, 32, 37. If the resulting value is higher than zero, both the ability to utilize unconventional parking locations and the coupling of trains must be evaluated.
- Fourth, as discussed in subsection 6.3.3, if there are no conventional parking locations available, the exploration of unconventional parking locations must be conducted. The exploration is conducted simultaneously for parking locations which are not immediately accessible along the route of the investigated line l_s and parking locations outside the commuter railway network. Eventually, an exploration of available platform tracks may also be explored as a last resort.

The exploration for unconventional parking locations is conducted simultaneously for parking locations that are not immediately accessible along with the line's route and parking locations outside of the network (see subsection 6.3.3). The exploration of these parking locations is conducted throughout the deviation routes (inside and outside of the commuter railway network) that have been established in subsection 7.3.1. The alternatives must be explored in correspondence to their driving distance measured from the deviation points along the lines' route and starting with the alternatives with the least driving distance. The available parking length (or number of vehicle compositions) throughout the identified unconventional parking locations is compared with that required by the vehicle compositions of the investigated line l_s , which must still be removed from the network. The maximum number of vehicles that can be parked throughout the unconventional parking locations n_{E,U,l_s} must be compared with the number of trains still to be removed from the network n''_{C,l_s} , as in equation 8.18.

$$n''_{C,l_s} + n_{E,U,l_s} \leq 0 \quad (8.18)$$

If the result from equation 8.18 does not satisfy the inequality, further parking locations at available platform tracks must be considered. The exploration of available parking locations is conducted as detailed in subsection 6.3.3 until all remaining parking locations have been identified (i.e. until equation 8.18 is satisfied). Further unconventional parking locations can also be introduced manually, indicating strategical locations around the network (e.g. at potentially accessible tracks in the disrupted station) and across stations outside of the commuter railway network.

3. The remaining determining variable is concerned with the ability to address the identified conflict through the coupling of trains. If the network does not have the necessary operational foundation to handle the coupling or decoupling of trains as discussed in subsection 6.3.7, this determining variable can not be assessed. As a result, the parking of trains in unconventional locations is highlighted as the only and last available option for resolving the conflict of the investigated line l_s . In this case, and depending on the already

assessed operational circumstances in the previous levels, the conflict can be classified as indicated in table 8.2 by one of the conflict classes respective to the numbers: 23, 25, 29, 31, 34, 36, 39, 41.

However, if the operational foundation to conduct the coupling of trains exists, it is evaluated in three steps:

- First, all the trains that circulate in the network and provide service to line l_s are divided into two groups with respect to their driving direction. The trains within each group are ordered sequentially, beginning with those with the least number of units in their vehicle composition. It must be noted that the coupling of units is limited to the largest vehicle composition permitted during operations (see subsection 6.3.7)
- Second, starting with trains recognized in the first step as driving towards the disrupted section, and observing the inherent limitations imposed by the DRP operating concept on the train services and circulation plans, specific vehicle compositions are identified for coupling. For example, vehicle compositions that are coupled as detailed by their circulation plan, cannot be allocated units that would engender the resulting vehicle composition to be technically incompatible with the infrastructure.

The exploration starts with the trains that drive towards the disrupted section so as to immediately reduce the number of vehicles circulating within the disrupted network. That said, if necessary, vehicles driving in the opposite direction can also be considered. Ultimately, if trains that can be coupled n_{CT,l_s} are identified among the examined vehicle compositions, these are compared with the number of trains required for the investigated conflict, as in equation 8.19.

$$n''_{c,l_s} + n_{CT,l_s} = n'''_{c,l_s} \quad (8.19)$$

- Third, if the resulting number of required trains for the investigated line n'''_{c,l_s} is equal to or less than zero (i.e. $n'''_{c,l_s} \leq 0$), the vehicle availability conflict for line l_s can be solved through a decoupling of trains. If the resulting number is higher than zero, the conflict results as an indirect combination of solutions, including the coupling trains and/or their removal from the network in unconventional parking locations. Nevertheless, depending on the already assessed operational circumstances in the previous levels, the conflict can be classified as indicated in table 8.2 by one of the conflict classes respective to the numbers: 22, 24, 28, 30, 33, 35, 38, 40.

8.4.4. Identification of Reachability Conflicts

While the trains circulating in the network at the time that the disruption has begun still follow their original schedules, the disruption undoubtedly affects their ability to perform their regular service along their routes. Therefore, regardless of whether or not these train services are included in the DRP operating concept, their ability to provide service across their originally scheduled route has been jeopardized and must be taken into consideration.

Trains that cannot reach the end station detailed in their assigned trains services, either due to the magnitude of the disruption (i.e. of a complete blockage) or their line-specific the DRP operating concept, are especially relevant. These trains are not able to reach all the stations foreseen by their

train service, generating the need to conduct supplementary operational actions to address these circumstances. Therefore, as discussed in subsection 3.7.2, reachability conflicts are identified by recognizing train services which started before the implemented and that cannot reach their end stations. In subsection 8.2, the identification of conflicting services is summarised in one single direct determining variable, namely, whether train services that started before the deployment time $t_{0,TD}$ are able to reach their end station.

By considering the sole established determining variable throughout all the trains circulating in the network and servicing a particular line l regardless of their side, would permit to identify all of its reachability conflicts. The sequence in which the lines are assessed is of no particular importance; however, the evaluation must ensure that all lines J are checked for reachability conflicts.

Establishing all Train Services Circulating in the Network that Started Before $t_{0,TD}$

The identification of reachability conflicts for the investigated line l focuses on evaluating the capability of train services to reach the end station appointed in its original schedule. By this stage, information on the actual location of the different trains at the time of deployment of the DRP has already been assessed during the clustering of trains into categories (see subsection 7.3). With the trains already clustered into one of the four categories, the identification of the reachability conflicts for an investigated line l can be immediately conducted.

Initially, all trains T_{l_s} clustered in the Green+ category G_{+l_s} on either side of the investigated line l can be immediately removed from the analysis, since these trains drive away from the disrupted section and are able to reach their end station. The identification of reachability conflicts for the rest of the trains in the other categories requires a much thorough analysis.

Regardless of the magnitude of the disruption (i.e. complete or partial blockage) and for lines divided into two sides by the DRP operating concept of the line (see subsection 5.3.1), all train services T_{l_s} clustered in the Green G_{l_s} , Yellow Y_{l_s} , and Red R_{l_s} categories on either side of the investigated line l that cannot reach the end station appointed in their original schedule are identified as generating a reachability conflict on the opposite side of the line. These conflicting train services are introduced in the set $rc_{l_s} \{Trc_{l_s}, \dots, Nrc_{l_s}\}$ of reachability conflicts for their respective lines on the affected side. It must be noted that each element Trc_{l_s} in the set of reachability conflicts does not represent the train in its physical sense but the train service that can no longer be supported in the opposite side of the line.

In case of a complete blockage and when a line is physically divided into two sides, but the DRP operating concept for the investigated line l foresees its deviation (see subsection 8.4.1), only the train services in Yellow Y_{l_s} and Red R_{l_s} categories can be positively identified as conflicting train services. Thereafter, these train services are included in the set of reachability conflicts $rc_{l_s} \{Trc_{l_s}, \dots, Nrc_{l_s}\}$ for the line on the opposite side.

An example of the identification of reachability conflicts is displayed in figure 8.6. The figure depicts a fictitious network that has been affected by a complete blockage where a DRP has been declared (displayed at the bottom of the figure). Furthermore, to simplify the example, the figure only depicts trains that begun their service before $t_{0,TD}$, plus every train has already been clustered into their respective train categories vis-à-vis the chosen DRP as discussed in subsection 7.3.

Consequently, trains are appointed to a set rc_{l_s} , containing the reachability conflicts for their respective lines and sides (represented by the red dots and lines – see figure 8.6).

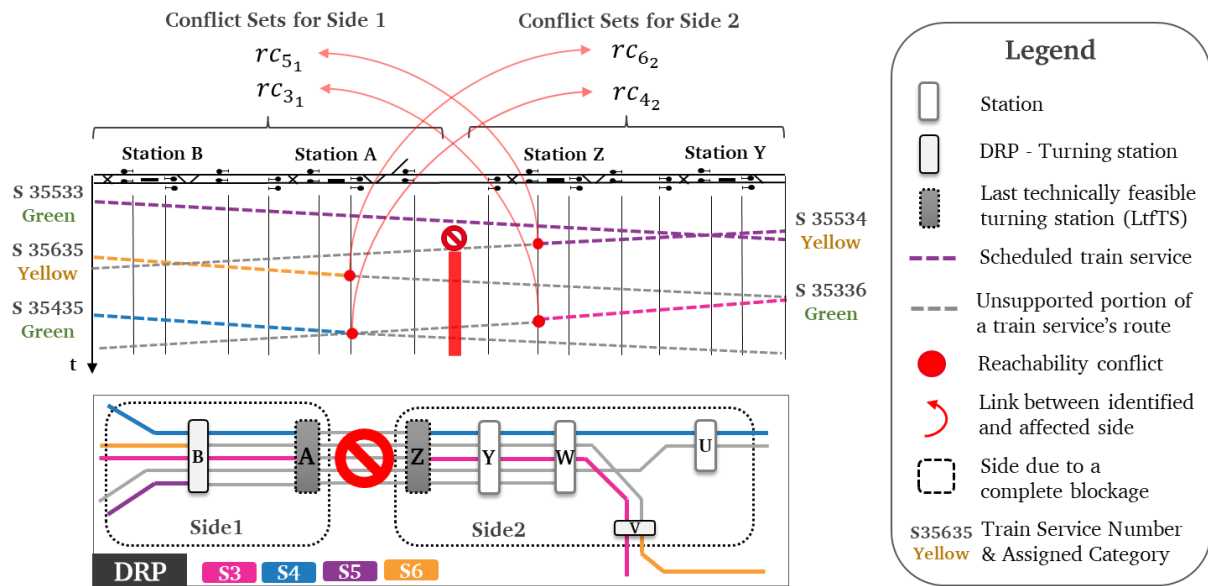

Figure 8.6 Example of the identification of reachability conflicts (by author)

The example presented in figure 8.6, is particularly relevant since it portrays the way in which the reachability conflict sets are established. A train that is located on one side of the disruption divided network generates a reachability conflict and is included in the conflict set of the same line but on the opposite side. For instance, train S35534 is located on side 2 and cannot keep driving beyond station Z; thus, it generates a reachability conflict for its line (i.e. $l = 5$) on the opposite side (i.e. $s = 1$).

8.4.5. Classification of Reachability Conflicts

The identification of reachability conflicts is complemented by their classification based on the determining variables detailed in subsection 8.2. Since the determining variables are inherently linked to the elemental conflict solution alternatives, the structure of the bundle of elemental conflict solution alternatives becomes particularly relevant. As discussed in subsection 8.3.1, and highlighted by the bundle of the six elemental conflict solution alternatives for reachability conflicts (see subsection 6.4.2), all solution alternatives operate on the same level. However, the potential availability and implementation of four of the six solution alternatives depend on the already classified vehicle availability conflicts, leaving the early turning of trains and the cancellation of train services as independent alternatives. These last two alternatives correspond to the two indirect determining variables detailed in subsection 8.2, namely, the availability of technically feasible turning stations and the cancellation of train services.

With the reachability conflicts for all lines J already identified, the classification process merges the particularities of the determining variables respective to the set of all identified reachability conflicts rc_{l_s} for an investigated line l across both of its sides, with the line's already classified vehicle availability conflicts. Since all conflict solution alternatives maintain the same level of relevance, both independent determining variables must be simultaneously assessed.

At the outset, as with vehicle availability conflicts, the classification of reachability conflicts requires a classification scheme. The general principles behind the scheme utilized to classify

vehicle availability conflicts are expanded to include the relevant determining variables to be considered for reachability conflicts. Consequently, the classification begins by considering the availability of technically feasible turning stations for the identified reachability conflicts across all sets rc_{l_s} . In the same way, the cancellation of an investigated conflicting train services Trc_i within the established sets is also taken into consideration. Ultimately, the results are merged with the already classified vehicle availability conflicts according to the respective line and side l_s .

Classification Scheme

Supporting the independence of the determining variables, and the inherent need for their merger with vehicle availability conflicts, the classification recognizes a total of eight different underlying classes of reachability conflicts.

As with the classification scheme of vehicle availability conflicts, the coding for the identified conflicts is also divided into two sections, as detailed by the example in figure 8.7. The initial section of the code highlights the reachability conflict type, the affected line and side, the nature of the vehicle availability conflict for the same line and, ultimately, the conflicting service being investigated. In the example, the initial portion of the code corresponds to a reachability conflict that takes place in line with a surplus of trains. The second section details the condition of the two independent solution alternatives for the reachability conflicts. In the example, the evaluation of the independent determining variables has established that there are available turning patterns across the turning stations in the critical area (i.e. ETT1, see respective subtitle) and that a potential cancellation of the service would result in potential service conflict (i.e. CS2, see respective subsections 3.7.2 and 6.3.13).

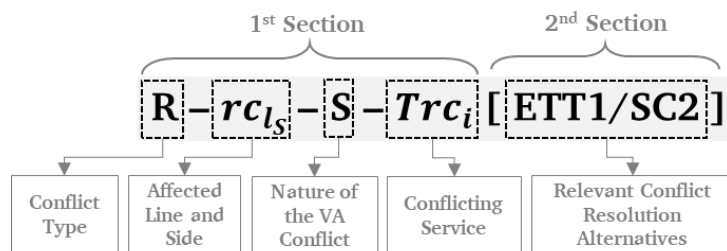

Figure 8.7 Coding utilized for the classification process of every identified reachability conflict (by author)

The classification scheme further details the identified reachability conflicts into one of the eight possibilities, as displayed in table 8.3. It must be noted that in case there are no vehicle availability conflicts identified for the investigated line, the category utilized is an “S”, which stands for the surplus of trains. The S is utilized as an incumbent to avoid creating more classes without any additional information and indicates that the four measures dependent on vehicle availability conflicts are not feasible solutions to the investigated reachability conflict.

Table 8.3 Solution-oriented classification scheme for Reachability conflicts (by author)

					Classification	N°	
Vehicle Availability Conflict	Surplus	(On-time) Turning Stations in the Critical Area	Available	Cancellation of the Service	Generated service interval less than the maximum service interval	(R- l_s -S- Trc_i [ETT1/SC1])	1
			Available	Cancellation of the Service	Generated service interval higher than the maximum service interval	(R- l_s -S- Trc_i [ETT1/SC2])	2
		Unavailable	Cancellation of the Service	Generated service interval less than the maximum service interval	(R- l_s -S- Trc_i [ETT2/SC1])	3	
				Generated service interval higher than the maximum service interval	(R- l_s -S- Trc_i [ETT2/SC2])	4	
	Lack	(On-time) Turning Stations in the Critical Area	Available	Cancellation of the Service	Generated service interval less than the maximum service interval	(R- l_s -L- Trc_i [ETT1/SC1])	5
			Available	Cancellation of the Service	Generated service interval higher than the maximum service interval	(R- l_s -L- Trc_i [ETT1/SC2])	6
		Unavailable	Cancellation of the Service	Generated service interval less than the maximum service interval	(R- l_s -L- Trc_i [ETT2/SC1])	7	
				Generated service interval higher than the maximum service interval	(R- l_s -L- Trc_i [ETT2/SC2])	8	

Appraisal of the Technically Feasible Turning Stations for the Reachability Conflicts in rc_{l_s}

Trains that service the investigated line l and are positioned on the investigated side l_s can be potentially utilized to address the conflicting train services identified in the set rc_{l_s} . Among these trains, those driving towards the disrupted section (i.e. trains in the Yellow and Green categories) must be turned at some turning station before they reach the disrupted section. The early turning of these trains, as discussed in subsection 6.3.6 (see also subsection 3.6.2), requires that they are assigned a train service in the opposite direction after their turn. Therefore, it is possible to assign to them one of the conflicting services in the set rc_{l_s} and immediately resolve the identified reachability conflict.

Nonetheless, identifying a station with the necessary infrastructural capabilities is essential for carrying out an early turn. As detailed in subsection 7.3, first-order and second-order turning stations for all lines J have already been identified. Elements recognized as being first-order turning stations have already been located around the disrupted network and do not require further contemplation (see subsection 7.3). However, since all technically feasible turning stations along the investigated line's route can be recognized as second-order turning stations, once the conflicting train services are identified, it is possible to identify the turning stations with the highest chance to induce an on-time train service after its turn (see subsection 3.6.2).

An evaluation of the technically feasible turning stations for the conflicting train services in the set rc_{l_s} , entails observing the possible effects of early turning trains driving towards the disruption at a given location in the network. Under specific operational circumstances, turning a train to a different train service of the same line in the opposite direction at a given location in the network can be evaluated with the turn residual principle, as discussed in subsection 3.7.2. The turn residual principle projects the delay generated by turning a train to a train service in the opposite direction at a specific location. Thus, the turn residual principle is a relevant tool that permits evaluating the operational impact (i.e. amount of the generated delay) of implementing potential early turns (turns) across a series of technically feasible turning locations on specific trains, while appointing them with different train services of the same line in the opposite direction.

Consequently, since trains T_{l_s} clustered in the Green G_{l_s} and Yellow Y_{l_s} categories for the investigated line l_s can be utilized to address the conflicting services in the set rc_{l_s} (see subsection 2.3.3), their early turning potential is evaluated utilizing the turn residual principle for the first-order and second-order turning stations along the investigated line (i.e. TS'_{l_s} ; TS''_{l_s}). As discussed

in subsection 3.7.2, the turn residual generated by turning a train T_{l_S} towards a conflicting service Trc_{l_S} at a particular turning station TS_a is derived by subtracting the projected departure time of the assessed train T_{l_S} after its early turn, from the scheduled departure time of the conflicting service $t_{Sched.Dep}^{TS_a}_{Trc_{l_S}}$. The projected departure of the assessed train at the assessed turning station stems from adding its initial delay $t_{v_{T_{l_S}}}$ and a minimum turning time $min t_{Turn}$ to its scheduled arrival time at the evaluated turning station $t_{Sched.Arr}^{TS_a}_{T_{l_S}}$ (see subsection 2.3.3 and 3.6.2). The evaluation of the turn residual $TR_{T_{l_S}-Trc_{l_S}}^{TS_a,l_S}$ is generalized in equation 8.20.

$$TR_{T_{l_S}-Trc_{l_S}}^{TS_a,l_S} = t_{Sched.Dep}^{TS_a}_{Trc_{l_S}} - t_{Sched.Arr}^{TS_a}_{T_{l_S}} - t_{v_{T_{l_S}}} - min t_{Turn} \quad (8.20)$$

The result of equation 8.20, represents the nature of the turn residual generated between the available and conflicting services at a particular turning station, namely, whether it is a positive or negative turn. The evaluation ought to be conducted individually for all conflicting services Trc_{l_S} in the set rc_{l_S} and all available trains T_{l_S} in the Green and Yellow categories of the investigated line l_S .

Since they are able to follow their respective line's operating concept, available trains in the Green category have the turn residual assessed only at the DRP turning station. For Yellow trains, the turn residual must be conducted across all first-order and second-order turning stations flagged for the line between the first station accessible to the investigated train, taking into account the journey time interval between the system's deployment time $t_{0,TD}$ and the minimum communication time $min t_{Comm}$, and the last technically feasible turning station (LtfTS).

The resulting turn residuals are organized in a matrix of turn residuals $TR_{Trc_{l_S}}$ for each conflicting train service Trc_{l_S} in the set rc_{l_S} , as detailed in equation 8.21. In the matrix, each row contains the value of the turn residual $TR_{T_{l_S}-Trc_{l_S}}^{TS_a,l_S}$ for a turn of an available train T_{l_S} towards an investigated conflicting train service Trc_{l_S} in the set rc_{l_S} at a turning station TS_a .

$$TR_{Trc_{l_S}} = \begin{bmatrix} TR_{T_{l_S}-Trc_{l_S}}^{TS_a,l_S} & \cdots & TR_{T_{l_S}-Trc_{l_S}}^{TS_z,l_S} \\ \vdots & \ddots & \vdots \\ TR_{N_{l_S}-Trc_{l_S}}^{TS_a,l_S} & \cdots & TR_{N_{l_S}-Trc_{l_S}}^{TS_z,l_S} \end{bmatrix} \quad (8.21)$$

To obtain a $m \times n$ matrix, each row starts with the turn residual of an available train T_{l_S} at the LtfTS towards an investigated conflicting train service Trc_{l_S} and finalizes with the turn residual computed at the first turning station that is accessible to the available train (i.e. stands beyond the journey time interval between the system's deployment time $t_{0,TD}$ and the minimum communication time $min t_{Comm}$ – see subsection 6.3.6). Since not all available trains would be able to access the same turning stations, if the turn residual cannot be calculated at a particular station, a large positive integer is introduced instead. The integer's value must be high enough to immediately evidence the lack of a feasible early turn of an available train towards a conflicting train service Trc_{l_S} at such station TS_a .

It must be considered that during the establishment of the turn residual matrix, no occupancy conflicts between trains are taken into consideration. This is due to the fact that at this stage in the implementation of the dynamic DRP deployment system, the focus is solely on exploring

potential solution alternatives. Furthermore, it should be noted that in case the already classified vehicle availability conflict for the investigated line l_S considers the potential use of a line-specific measure that would widen the range of trains that can be turned early (e.g. exchange of trains between corresponding lines); these trains must be included in the analysis as available trains. For example, in the case where an exchange of trains between corresponding lines l_ξ is anticipated, the trains T_{l_ξ} clustered in the Green and Yellow categories must also be assessed and included in the matrix. Nonetheless, the assessed turning stations must be located in the area that overlaps between the routes of the corresponding lines.

Overall, the evaluation of turn residuals facilitates the identification of specific locations in the network where the early turning of available trains to the identified conflicting train services throughout a series of technically feasible turning stations (i.e. turning pattern) may potentially generate a minimum impact on the operations. To make the exploration of potential turning stations more focused on the transition to stable operations as required by the system requirements (see subsection 3.4.2), additional requirements may be included.

For example, the assessment of the turn residuals can seek to identify the technically feasible turning stations where the turn residuals produce values closer to zero. This would allow establishing the turning station(s) in the network with the highest potential to minimize the adverse effects on the operating situation, namely, a delayed train after the transition between train services for a negative turn, or a waiting time at the platform track for positive turns (see subsections 3.6.2 and 3.7.2, respectively), after early turning an available train to a given conflicting train service.

Another alternative may be to focus the exploration of potential turning stations to those located near the disrupted section on each side of the network (e.g. within the critical area). As discussed in subsection 2.3, during the transition to stable operations, this area is heavily congested and is the source of most of the delays generated in the network. In consequence, the capacity consumption of infrastructural elements within the critical area is of critical importance for the transitioning of the network to stable operations. In this regard, it must be considered that while positive turns don't generate a delayed train service after the turn (see subsection 3.7.2), they induce an irreversible idle consumption of capacity at the turning station. The unnecessary consumption of capacity in stations within the critical area has the potential to generate delays for other trains, meaning that positive turns are, in fact, the least favourable option. On the other hand, despite negative turns result in a delayed train after the turn, they also ensure the immediate and versatile handling of such trains within the critical area. Thus, negative turning residuals, which engender trains with a delay within the on-time threshold (i.e. t_{Ot}) are of particular importance (see subsection 3.6.2). As discussed in subsection 3.6.2, the on-time threshold t_{Ot} is highly dependent on the implementing context (i.e. railway system) and refers to the maximum amount of delay a train service can have and still be regarded as being "on-time".

Within each matrix $TR_{Trc_{l_S}}$ the ability to remove these trains from the critical area without inducing further delays is evaluated. The turn residuals for all turning patterns across the stations in the critical area are evaluated, as displayed in equation 8.22.

$$t_{Ot} \leq TR_{T_{l_S}-Trc_{l_S}}^{TS_{a,l_S}} \leq 0 \quad (8.22)$$

Having acquired an overview of all possible turning stations and the resulting turning patterns for every conflicting service, the projected capability to conduct the early turn of trains inside or

outside the critical area as a solution alternative has been ascertained. Ultimately, this information allows classifying the conflicts into two classes. First, there are those conflicting train services for which there are available turning patterns that may potentially generate a train service within the on-time threshold if turned at one of the technically feasible turning stations in the critical area (i.e. ETT1). As indicated in table 8.3, these conflicts can be classified as class numbers: 1, 2, 5 and 6. Second, there are those conflicting services for which there is no turning pattern that would potentially generate a train service within the on-time threshold if turned in the critical area (i.e. ETT2), as indicated in table 8.3 by the conflict class numbers: 3, 4, 7 and 8.

Evaluation of the Cancellation of a Conflicting Train Service in rc_{l_s}

As discussed in subsection 3.5.2, cancelling a train service impacts on passenger welfare. Having identified the conflicting train services Trc_{l_s} that may potentially be cancelled, it is now possible to ascertain whether a service conflict will be generated, affecting the serviceability of the investigated line l_s . As discussed in subsection 3.7.2, service conflicts occur when the service interval is larger than the maximum service interval. The maximum service interval is equal to the service interval foreseen in the DRP operating concept of the cancelled train service's line (see subsection 3.7.2).

Consequently, due to the cancellation of a conflicting train service Trc_{l_s} at an affected station S_a , the generated service interval $t_{SI_{Trc_{l_s}}}^{S_a}$ can be established by determining the difference in the departure times of the subsequent $t_{Dep_R}^{S_a}$ and prior $t_{Dep_Q}^{S_a}$ train services projected to arrive at the affected station. The selection process of these services has been discussed in detail throughout subsections 3.7.2 and 6.3.13. Nevertheless, since the overall approach is based on the establishment of multiple potential solutions (i.e. PVSCS – see subsection 3.5.2) for different trains, at this point, it is not possible to ascertain with precision the subsequent or prior train services nor their respective departure times from different stations. Therefore, for the classification of reachability conflicts, the services in the original schedule may be used as an overall guide.

The service interval $t_{SI_{Trc_{l_s}}}^{S_a}$ can be ascertained as detailed by equation 8.23 and must be evaluated across all the stations affected by the cancellation of the train service.

$$t_{SI_{Trc_{l_s}}}^{S_a} = t_{Dep_Q}^{S_a} - t_{Dep_R}^{S_a} \quad (8.23)$$

As detailed in subsection 3.7.2, the maximum service interval is equal to the service interval of the line's DRP operating concept $t_{SI,DRP,l_s,\psi}$. This value must consider the existence of different cycle variants ψ for the line. Thus, to establish the adequate maximum service interval, the end station and route of the conflicting service Trc_{l_s} must be compatible with the respective cycle variant for the affected line. Therefore, the maximum service interval $t_{SI,max}^{S_a}_{Trc_{l_s}}$ must acknowledge the existence of the different cycle variants and select the service interval for the DRP operating concept that matches the end station and route of the cycle variant ψ , as generalized in equation 8.24.

$$t_{SI,max}^{S_a}_{Trc_{l_s}} = \begin{cases} t_{SI,DRP,l_s,\psi} \\ \dots \\ t_{SI,DRP,l_s,\psi} \end{cases} \quad (8.24)$$

Having identified the generated and maximum service intervals across the stations affected by a potential cancellation of the conflicting trains service, the location where a service conflict is likely to occur must be established. These locations are in stations where the generated service interval for the cancelled trains service $t_{SI}^{S_a}_{Trc_{l_S}}$ is larger than the maximum service interval $t_{SI,max}^{S_a}_{Trc_{l_S}}$, as detailed in equation 8.25.

$$t_{SI}^{S_a}_{Trc_{l_S}} > t_{SI,max}^{S_a}_{Trc_{l_S}} \quad (8.25)$$

Ultimately, in order to classify the conflicting train service, the station S_a with the most significant difference between the generated service interval and the maximum service interval, is identified. This value is the representative value for the conflicting service Trc_{l_S} , as detailed in equation 8.26.

$$\max \left(t_{SI}^{S_a}_{Trc_{l_S}} - t_{SI,max}^{S_a}_{Trc_{l_S}} \right); \text{ for all } S_a; \text{ where } \left\{ t_{SI}^{S_a}_{Trc_{l_S}} \geq t_{SI,max}^{S_a}_{Trc_{l_S}} \right\} \quad (8.26)$$

The above-detailed exploration is conducted for all conflicting train services Trc_{l_S} in the sets rc_{l_S} . As with turning station availability, the potential cancellation of a conflicting service Trc_{l_S} is differentiated between two classes. First, there are those conflicting train services where a cancellation would potentially result in a service conflict (i.e. CS1), as indicated in table 8.3 by the conflict classes number: 1, 3, 5 and 7. Second, there are those conflicting train services where a cancellation would have the potential to cause a service conflict (i.e. CS2), as indicated in table 8.3 by the conflict classes number: 2, 4, 6 and 8.

8.4.6. Summary

This subsection has discussed the identification and classification of line-specific conflicts, namely, vehicle availability and reachability conflicts. The classification process considers the occurrence of each of the identified line-specific conflict types in detail as well as the potential conflict solution alternatives that can be implemented to address the identified conflicts.

Aligned with the structured approach detailed in subsection 8.3.2, the subsequent subsection explores all identified and classified conflicts and sorts them into one single conflict list for the entire disrupted network.

8.5. Sorting and Construction of a Conflict List for all Line-Specific Conflicts

As discussed in subsection 3.6.2, conflicts can be sorted by distinguishing between different characteristics. However, to align the sorting of the line-specific conflicts with the overall approach of the dynamic DRP deployment system (see subsection 3.5.2), their temporal occurrence is the principal character to observe.

At the outset, line-specific conflicts occur as a product of a line's disrupted operations, thus, during the implementation of its DRP operating concept. Consequently, in the context of the dynamic DRP deployment system, it is possible to assert that all line-specific conflicts occur simultaneously the moment that the system is deployed (i.e. $t_{0,TD}$). Such circumstances prevent the sorting of line-specific conflicts solely based on their temporal occurrence. As a result, the sorting considerations must be broadened so as to support the sorting of conflicts such that they can be organized in one unified conflict list.

Throughout the existing CDCR approaches discussed in subsection 2.3.3, other aspects that can be considered for the sorting of conflicts include: the location or number of parties involved in the conflict. Thus, the conflict location can also be utilized to sort the conflicts on the list. However, since line-specific conflicts consider matters that affect an entire line, the identified conflicts cannot be pinpointed in one specific location in the network, as is the case for vehicle-specific conflicts. In order to deal with the vague spatiotemporal occurrence of line-specific conflicts and at the same time support their sorting from a temporal perspective, a robust sorting approach must be put forward.

A possible approach can concentrate on sorting the conflict list for the affected lines according to the projected arrival of their trains to the disrupted section. From a strict dispatching perspective, trains that are projected to arrive first to the LtfTS on either side of the disruption must be handled first. Therefore, the projected arrival of an affected line's first train to the LtfTS would also allow highlighting which affected line for their specific side (if applicable) must be considered first. This approach allows establishing a much more concrete temporal determining variable for the sorting process. The sorting of the line-specific conflicts following this approach would systematically investigate the trains across both sides of the disruption in correspondence to their projected arrival at the LtfTS, introducing the lines in the conflict list until all affected lines have been accounted for. It must be noted that the projected arrival of a train to the LtfTS within the current module would simply entail a prognosis based on the train's movement in an empty network.

Furthermore, in case two trains are projected to arrive at the LtfTS at the same time, another distinguishing factor must be established. One possibility is to prioritize the line and side (if applicable) classified with the worst vehicle availability conflict (i.e. lack of vehicles) and which includes the broadest range of possible solution alternatives. Another possibility is focusing on reachability conflicts and the number of conflicting train services that, if cancelled, can derive in a service conflict. Further sorting considerations can be inherently found in the classification scheme provided to the identified line-specific conflicts (see subsections 8.4.3 and 8.4.5). However, since the vehicle availability conflicts of an affected line and side (if applicable) are fundamental for the handling of both line-specific conflict types, these are prioritized in the sorting process.

As a result, the sorting of the line-specific conflicts in the list is performed according to the three orders of relevance detailed below. These are systematically performed until all lines and sides (if applicable) have been arranged.

- i)* The first level observes the temporal occurrence of the conflicts and arranges the identified conflicts according to the projected arrival of the line's first train to the LtfTS of its respective side (if applicable). However, an alternative approach must be established in case a line's DRP operating concept, or its originally scheduled route impede trains to reach the LtfTS. In this case, the temporal occurrence of the conflict for the respective line and side (if applicable) is established according to the projected arrival of its first train to the DRP turning station, or deviation point.
- ii)* The second level recognizes all conflicts with the same temporal occurrence and concentrates on the already classified vehicle availability conflict. Thus, conflicts are further arranged vis-à-vis the identified vehicle availability conflict, listing at the top conflicts with the widest range of potential conflict solution alternatives. The more elemental solution alternatives are potentially required to address the conflict, the more complex is the identified vehicle availability conflict (see subsection 8.4.3). Therefore,

there is a direct relation between the number of elemental conflict solutions that are required and the severity of the identified vehicle availability conflict.

- iii) Finally, for conflicts with the same vehicle availability classification, their reachability conflict classification becomes essential. This entails listing at the top the lines with the largest number of conflicting train services that, if cancelled, would induce a service conflict.

The sorting process ultimately results in a conflict list, containing all classified line-specific conflicts for all the affected lines and sides, and arranged according to the temporal handling of all trains in the network. Within each line and side, the sorted conflicts start with the vehicle availability conflicts followed by all reachability conflicts. The sorted list provides sufficient detail to distinguish the potential conflict solution alternatives, which have been established to address each of the identified conflicts.

8.6. Closing Remarks

Throughout this section, a structured approach that supports the identification, classification, and sorting of line-specific conflicts of all affected lines in the network and aligned with the chosen DRP operational concept has been introduced.

Overall, by means of the structured approach, an overview regarding the operating condition of every affected line in the network at the beginning of the disruption, as detailed in subsection 3.5.2, can be acquired. The detailed processes within the approach provide a closer look at the generalized stock tacking of available resources and the evaluation of the actual operational circumstances of the affected lines in concordance with the targeted DRP operating concepts. Furthermore, they provide a clear outline of the measures that can be implemented at a vehicle-specific level in order to address the network-wide disrupted circumstances.

Inspired in existing vehicle-specific conflict identification models (see subsection 2.3.3), the structured approach incorporates the four necessary steps, namely, the identification, classification, sorting, and the creation of a line-specific conflict list. However, it is through a solution-oriented classification of the line-specific conflicts (see subsection 8.2), that the module is able to establish potential conflict solution alternatives to address the identified line-specific conflicts. The module recognizes 41 different classes of vehicle availability conflicts and 8 different classes of reachability conflicts, which ultimately provide the system with a general outline for addressing the disruption with a broader overview of the actual degraded operational circumstances.

The central role played by the vehicle availability within the line-specific operational level can be appreciated in the structure outlined in subsection 8.3 and also throughout the classification processes detailed subsection 8.4. The capability with which this module is able to account for vehicle resources highlights the adeptness of an approach that distinguishes between the two operational levels (line-specific, vehicle-specific).

Furthermore, the line-specific conflict identification and establishment of potential conflict solution alternatives relies on information from other modules, particularly from the DRP operating concept, the DRP set-up module and the elemental conflict solution alternatives module (respectively subsection 5.3, 7.3 and 6.4). Without this information, the necessary processes described in this module could not have been completed. However, as discussed in subsection 3.4.2, the availability of the DRP operating concept for each of the affected lines, is perhaps the

central element that permits deriving such a representative evaluation of the network's operating condition at the beginning of the disruption like the one acquired by the resulting conflict list attained through this module.

The resulting conflict list, containing each of the classified line-specific conflicts developed in this section will be further handled in further modules of the dynamic DRP deployment system. As discussed within the dynamic DRP deployment system overall approach (see subsection 3.5.3), it is only through the establishment of potential conflict solution alternatives for the line-specific operational level that the development of the Potential Vehicle-Specific Conflict Solutions in Time and Space (PVSCS) can be developed. Therefore, with the information derived from this module (i.e. the classified and sorted conflict list for every line and side), the different PVSCS for each of the trains circulating in the network are developed in the following section.

9. Development of Potential Vehicle Specific Conflict Solutions in Time and Space (PVSCS)

9.1. Introduction

In the previous module, the line-specific conflicts for the entire disrupted network have been identified, classified and sorted in one single conflict list (see section 8). The generated conflict list distinguishes between vehicle availability and reachability conflicts. Furthermore, due to the classification structure implemented in the previous module during the identification of the conflicts, potential conflict solution alternatives to address the identified line-specific conflicts have been recognized with a line and side specific detail. However, as discussed in subsection 3.5.2, while the line-specific conflicts in the list are established at a line-specific level, they must be addressed at a vehicle-specific level. Therefore, the potential conflict solution alternatives must be allocated to the trains circulating throughout the network. This subsection details the allocation of the potential conflict resolution alternatives to each train circulating in the network according to the line-specific conflicts identified for their respective lines.

The dynamic DRP deployment system strives to cover the broadest range possible of handling alternatives that can be appointed to every train to systematically address the line-specific conflicts in the list (see subsection 3.4.2). This would allow the system to explore different dispatching options for the implementation of the line-specific DRP operating concept on the actual operating situation (see subsection 3.2.2). For this purpose, as derived in subsection 3.5.2, the system's approach foresees the development of a series of Potential Vehicle-Specific Conflict Solutions in Time and Space (PVSCS) that are generated for every train in the network. Every PVSCS constitutes a line-specific elemental conflict resolution alternative to address the line-specific conflicts that have been identified for a train's line in section 8. Furthermore, every PVSCS contains the necessary spatiotemporal information for the adjustment of the train's schedule and circulation plan aligned with the system requirements (see subsection 3.4.2).

As discussed in subsection 3.5.2, different PVSCS are generated for a given train, which are established by a combination of three basic components (i.e. handling alternatives):

- potential solution alternatives to address the line-specific conflicts of a train's line (i.e. dispatching measures),
- infrastructural elements that facilitate the solving the line-specific conflicts (e.g. deviation points, turning stations, etc.),
- potential transition train services to adjust the circulation plans (in both driving directions).

Overall, the structure of the dynamic DRP deployment system supports the handling of the PVSCS and it is arranged as a two-step fixing heuristic (see subsection 3.5.2 and 3.5.3). First, a series of PVSCS are developed for every train in the network. The PVSCS are developed without considering their interaction with other trains, which allows reducing their developmental complexity and supports the development of as many PVSCS as possible for every train. Later, the developed PVSCS for each train are selected and combined with PVSCS of other trains so that they may be fixed (i.e. solve every vehicle-specific conflict) to attain the targeted conflict-free schedule as foreseen by the specific objectives of the system (see subsection 3.2.2) (see section 10).

As the first step in the repairing heuristic, this section describes the development of the PVSCS for every train, which entails the allocation of the most suitable elemental conflict solution alternatives identified by the line-specific conflicts in the conflict list (see section 8) at the vehicle-specific level (i.e. for every single train). As discussed in subsection 3.5.2, the development complexity of the different PVSCS should be curbed in order to ensure the efficient and effective establishment of the pursued train number and minute-specific schedule as foreseen by the system requirements and limitations (see subsection 3.3.2 and 3.4.2). Therefore, each PVSCS is developed considering an empty network and utilizing a right-shift rescheduling approach, which allows to introduce the spatiotemporal information required for their development (see subsections 3.5.2 and 2.3.2). The right-shift rescheduling approach relies intensively on the original schedule and the attributes of the infrastructural elements in the enhanced macroscopic model as prime sources of the spatiotemporal information (see subsection 2.2.2). Additionally, since every train circulating in the network can have more than one PVSCS developed, a set of PVSCS is established for every train, as detailed in the overall approach (see subsection 3.5.2). However, to ensure that the disruption-management through the use of the different PVSCS is aligned with the deployment of the DPR operating concept and as a way to facilitate their management in subsequent modules (see section 10), every developed PVSCS must be verified to ensure it has technical and operational feasibility before it is introduced in the PVSCS set of every train as discussed in subsection 3.5.2.

This module seeks to derive a heuristic approach for the development of the PVSCS for every train in the network. The module should be able to support the development of the PVSCS for every train, as foreseen in subsections 3.5.2 and 3.5.3. The development of the PVSCS must be able to isolate different infrastructural elements and potential transition train services for every train based on the potential line-specific conflict solution established for every line and side (if applicable - section 8) and the train's actual position in the network the moment the system is being implemented (see subsection 3.5.2). Additionally, the module should also be able to systematically select the isolated elements (i.e. basic components) as the foundation for the development of every PVSCS. Moreover, based on every set of chosen elements, the module must be able to derive the necessary spatiotemporal information, namely, a projection of the movement of the train throughout the infrastructure, including any transition between train services (aligned with the right-shift rescheduling). Finally, the module should also support the verification of the technical and operational feasibility of every PVSCS that is developed before it is introduced in the PVSCS set of a train.

Ultimately, every PVSCS that is developed by this module may include:

- A line-specific conflict solution(s) to address an existing line-specific conflict
- A specific route and the spatiotemporal information throughout the infrastructural elements (i.e. route within the nodes, arrival and departure times) considering an empty network and abiding by the chosen line-specific conflict-solutions
- A set of transition train services adjusting the circulation plan for every vehicle or vehicle composition constituting a train (see subsection 3.6.2), including the potential involvement with other trains due to coupling or decoupling

In the following subsections, a structured approach and its respective processes to develop the PVSCS combinations are derived and discussed in detail. The following subsection 9.2 derives the structured approach for the development process of PVSCS based on the requirements and limitations discussed in subsection 5.3.2. Next, subsection 9.3 to subsection 9.8 discusses each of

the processes within the structured approach to developing each of the PVSCS for every train as part of the dynamic DRP deployment system.

9.2. Structured Approach for the Development of PVSCS

In the previous module, potential line-specific conflict solution alternatives have been identified for each of the lines in correspondence with their operating situation, the line-specific DRP operating concept, and the elemental conflict solution alternatives detailed in subsection 6.4 (see subsection 8.4). This subsection details a structured approach for developing the different PVSCS for every train utilizing as a foundation the information in the line-specific conflict list (see subsection 8.5).

In the following subsections, the structured approach to develop the different PVSCS for every train, including its respective processes, are derived. Since the structured approach to develop the PVSCS must be purposefully aligned to support the requirements of the dynamic DRP deployment system (i.e. meaningful solutions and efficient computation) (see subsection 3.4.2), the general requirements and limitations for the development of the different PVSCS are first discussed in subsection 9.2.1. Later, in subsection 9.2.2, a structured approach for the development of the different PVSCS for every train aligned with the requirements discussed in subsection 9.2.1 is derived and discussed in detail.

9.2.1. Requirements and Limitations for the Development of PVSCS

The development of the different PVSCS for every train constitutes the beginning of the first step in the two-step repairing heuristic, as discussed in subsection 3.5.2. Each PVSCS being developed through this module is arranged in a PVSCS set for every train, which is later utilized in section 10 to assemble the PVSCS combinations (see subsections 3.5.3 and 3.7.2). This subsection presents a detailed exploration of the requirements and limitations for deriving a heuristic approach supporting the development of every PVSCS as part of the dynamic DRP deployment system.

In general, the inputs for the development of the different PVSCS for each train are: the actual location of every train in the network and the sorted line-specific conflict list. The line-specific conflicts in the list have been classified to distinguish the potential line-specific solutions alternatives that are required to solve the identified line-specific conflict, respective to its line and side (if applicable) (see subsection 8.4). These inputs are processed to develop a series of PVSCS for a given train by a selection and combination of three basic components (i.e. handling alternatives), as detailed in subsection 3.5.2:

- potential solution alternatives to address the identified line-specific conflicts of a train's line (i.e. dispatching measures),
- infrastructural elements that support in the process to solve the line-specific conflicts,
- potential transition train services to adjust the circulation plans.

Together the three basic components constitute the boundary condition for the development of the different PVSCS for every train. While the potential conflict solution alternatives to address the identified line-specific conflicts of a train's line can be obtained from the classification approach utilized to establish the line-specific conflict list (see subsections 8.4 and 8.5), the infrastructural elements that support the resolution of the line-specific conflicts and the potential transition train services that can be appointed to a given train, must still be identified. Therefore, the PVSCS

development process must be able to isolate infrastructural elements and potential transition train services for every train.

Isolating the infrastructural elements and potential transition train services should be conducted in such a way that the handling of the train is aligned with the system requirements (see subsection 3.4.2), particularly, abiding by the chosen DRP operating concept and upholding the capability of the network to transition to stable operations. Therefore, the following aspects must be considered during the isolation of the three basic components:

- The infrastructural elements that can be accessed by a train must be established in such a way that the handling of the train not only addresses the line-specific conflict but also supports the DRP operating concept of its line and the transition of the network to stable operations.
- The potential transition train services must be established in such a way that they are compatible with the driving direction of the train, are not already being serviced in the network (considering a potential differentiation between sides), are foreseen in the DRP operating concept of its line and side (if applicable), and cover the estimated length of the disruption (i.e. t_{EDL} – see subsection 5.4). The need to use special train numbers for the transition train services must also be taken into consideration (see subsections 5.3.2 and 3.6.2).

As detailed in subsection 9.1, a selection and combination of the isolated elements in each of the three components should be derived in the development of a PVSCS. In this regard, in order to fulfill the system requirements for an efficient exploration of the different conflict resolution alternatives (see subsection 3.4.2), a robust framework that strategically manages the selection of the isolated elements to develop the PVSCS ought to be derived.

Furthermore, as discussed in subsection 3.5.2, the actual development of every PVSCS is conducted utilizing a right-shift rescheduling approach. The right-shift rescheduling foresees utilizing the spatiotemporal information from the schedule as the foundation of the rescheduling and considering the network as being empty. Therefore, the PVSCS development process must be able to incorporate the spatiotemporal information from the schedule such that the three isolated components that have been previously chosen can be translated into a string of nodes connecting the actual location of the train with objective of the line-specific elemental conflict solution and the foreseen transition between train services for the adjustment of the circulation plan. Additionally, the implementation of the line-specific solution must take into consideration the solution approach of every pre-defined elemental conflict solution alternative that is being implemented (see subsection 6.3). Moreover, since the right-shift rescheduling approach has been advanced within the context of ad-hoc disruption-management (see subsection 2.3.2), the necessary modifications must be identified so as to allow the approach to be fully compatible with the planned disruption-management approach and the dynamic DRP deployment system (see subsection 2.3.3).

Considering the broad range of elements that can be isolated in the list of the three basic components for every single train, it is possible to foresee the ample number of PVSCS that can be developed. As discussed in subsection 3.5.2, the system's overall approach foresees the verification of the technical and operational feasibility of every PVSCS that is being developed. The verification would ensure that only different PVSCS with technical and operational feasibility are ultimately introduced in the PVSCS set of every train (see subsection 3.7.2). Therefore, the PVSCS

development process must derive and establish the necessary process to ensure that every PVSCS combination is technically and operationally verified. The verification can be conducted utilizing principles established in existing approaches, as the one discussed in Brauner (2019) (see subsection 3.5.2).

Finally, since the line-specific conflicts have been listed following three orders of relevance (see subsection 8.5), the development of the line-specific conflict resolution alternatives, namely, the different PVSCS for every train, should be conducted in such way that they are compatible with the order of the conflicts in the sorted list. Therefore, an investigation order of each of the trains in the system must be derived in such a way that the line-specific conflicts in the list can be solved.

9.2.2. Structured Approach for the Development of Different PVSCS for Every Train

The requirements and limitations considered in the previous subsection have laid the groundwork for the establishment of the PVSCS development process. This subsection merges the requirements and limitations discussed in subsection 9.2.1 with the system's general approach discussed in subsection 3.5.2 and derives a structured approach to develop the different PVSCS for every train circulating in the network.

Overall, the structured approach supporting the development of the different PVSCS for every train is projected in two general phases.

The first phase is constituted the actual development of the different PVSCS of a train (see subsection 9.2.1). This phase entails the isolation of the three basic components (i.e. handling alternatives) for the investigated train, the selection of isolated elements and the development of the different PVSCS. To abide with the requirements discussed in subsection 9.2.1, the selection of the isolated components should be supported by a robust framework. A robust selection framework would allow a much more effective selection of the isolated components for the development of further PVSCS. Therefore, by incorporating information of already developed and verified PVSCS, the selection of further isolated components would be done strategically, supporting an efficient and effective development of PVSCS for the same train.

The second phase entails the technical and operational verification of the already developed PVSCS and the arrangement of the verified PVSCS in the PVSCS set of the investigated train. Additionally, as discussed above, information from already verified PVSCS should be communicated to the developmental phase (i.e. first phase) to facilitate the selection of the isolated elements.

Taking into account the specific processes within each of these phases, in particular, the need to transmit information from the already verified PVSCS to the selection of isolated components, the two phases are arranged in series.

The structured approach for the development of the PVSCS is displayed in figure 9.1. An iterative process that foresees the systematic development of the different PVSCS for a given train is established in order to abide with the need to address the conflicts as they have been sorted in the line-specific conflict list. Therefore, an investigation order i compatible with the sorting of line-specific conflicts is assigned to each of the trains $T_{l_s,i}$.

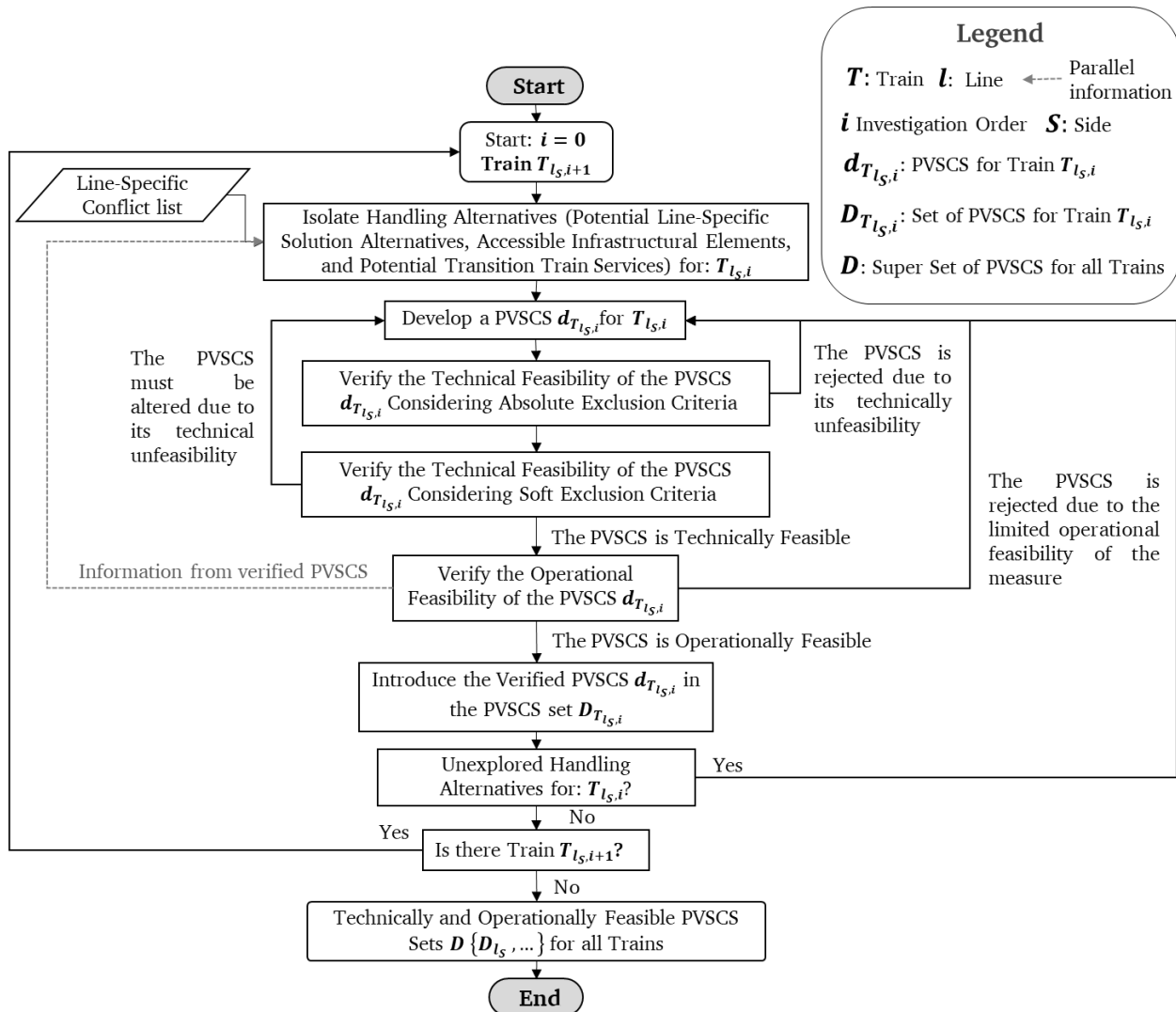

Figure 9.1 Structured approach for the systematic development of PVSCS for every train in the network (by author)

The development of the PVSCS is divided into six steps, as displayed in figure 9.1.

1. An *investigation order* i across all the trains circulating in the network aligned with the sorted conflicts in the line-specific conflict list is established for the development of the conflict resolution alternatives (i.e. PVSCS).
2. According to the actual location of the investigated train $T_{l_s, i}$, the accessible infrastructural elements, potential line-specific solution alternatives from the conflict list and potential transition train services for the adjustment of the circulation plan are *isolated*. These elements constitute the three basic components that combined constitute all possible handling alternatives for each of the trains (see subsection 9.2.1).
3. One element from each of the three kinds of isolated components, namely, accessible infrastructural elements, potential line-specific conflict solution alternatives and potential transition train services, are *selected*. With the selected elements, a PVSCS should be *developed* by utilizing the right-shift rescheduling approach and considering an empty network, as discussed in subsections 3.5.2 and 9.2.1. The development of the PVSCS must be conducted for every elemental conflict solution alternative that is implemented, following the steps detailed in subsection 6.3.

-
4. Employing absolute and soft exclusion criteria, the *technical feasibility of the developed PVSCS is verified*. PVSCS elements that do not comply with the absolute exclusion criteria are immediately rejected, and those which are incompatible with the soft exclusion criteria have the chance to be modified to fit the technical situation (see subsection 3.3.2).
 5. The PVSCS are *verified to determine their operational feasibility*, which implies scrutinizing if the PVSCS is able to transition to stable operations (see subsection 2.3.3 and 3.6.2). The information from the developed and verified PVSCS is communicated to step 3, to support in the selection and combination of further isolated components.
 6. Sixth, the resulting PVSCS are arranged *in a set of technically and operationally feasible PVSCS* for an investigated train. The size of the resulting sets depends on the number of available solution alternatives to tackle the identified vehicle availability and reachability conflicts for the train's line. It also considers the potential transition train services and accessible infrastructural elements. The development of the PVSCS is conducted until all the trains in the network are assigned at least one technically feasible PVSCS.

The six steps discussed above constitute the structured approach for developing the PVSCS for every train in the network and aligned with subsection 3.5.2. Each of the six steps is further detailed in the forthcoming subsections providing a much detailed discussion regarding the particular processes and necessary approaches.

In the first instance, discussed in subsection 9.3, an approach to establish the investigation order i of the trains is derived and detailed. Later, in subsection 9.4, abiding by the requirements discussed in subsection 9.2.1, a process describing the isolation of the three basic components that constitute the handling alternatives of an investigated train is discussed. Thereafter, in subsection 9.5, the selection of the handling alternatives, together with the actual PVSCS development process based on the right-shift rescheduling approach, is derived. Subsection 9.6 and 9.7, details the operational verification aligned with the existing approaches described in subsection 2.3.3. Finally, in subsection 9.8, the arrangement of every PVSCS develop for a given train in the PVSCS set is discussed.

9.3. Establishing the Investigation Order for Trains

Since the development of the PVSCS is the first step of the adjustment of the schedule and circulation plan in response to the disrupted operations, the investigation order must be compatible with the system's overall handling of conflicts in the line-specific conflict list. The establishment of an investigation order $T_{l_s,i}$ has the main objective of supporting the systemic development of PVSCS for every train in the network according to the line-specific conflict sorted in the list. Therefore, the sorted line-specific conflict list informs the establishment of an investigation order for all trains in the network (see subsection 8.5).

As discussed during the sorting of the line-specific conflicts, the order in which the identified conflicts of the affected lines are introduced in the list is mainly determined by the projected arrival of their first train to the LtFTS (see subsection 8.5). However, some exceptional cases needed to be recognized, namely, in case the DRP operating concept of a line impedes the first train to reach the LtFTS, and in case the originally scheduled route of a line never reaches the LtFTS. In these cases, the projected arrival of the first trains to the DRP turning station or deviation point is taken into consideration.

Establishing the investigation order analogously to the sorting of the line-specific conflicts would further support the synchronous handling of the conflicts in the list (see subsection 8.5). While the sorting of the line-specific conflicts only considered the first train driving towards the disrupted section as a representative for its line and side (if applicable), the establishment of an investigation order $T_{l,s,i}$ is extended to every single train in the network. As a result, further requirements are needed to complete this task. These are advanced considering the magnitude of the disruption discussed in subsection 5.3 (i.e. complete and partial blockage) and summarized in figure 9.2.

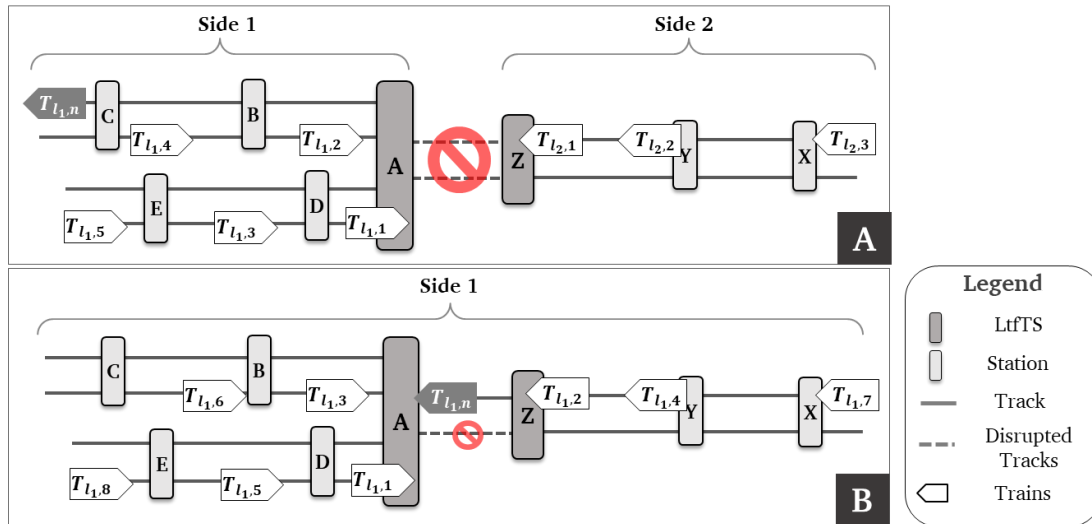

Figure 9.2 General example for the establishment of the investigation order for every train (by author)

Figure 9.2-A depicts a complete blockage between stations A and Z, which divides the network into two different sides. Under these circumstances, the investigation order is assigned in relation to the projected arrival time of each of the trains to the LtfTS, or eventually, their DRP turning station or deviation point on each side of the disruption divided network across all the affected lines. Figure 9.2-B depicts a partial blockage in the network, which transforms the link between stations A and Z into a single-track section. In this case, the investigation order of the trains is assigned throughout the whole network in correspondence to every train's projected arrival time to the LtfTS, or eventually, their DRP turning station or deviation point on each side of the disruption divided network. While these guidelines are valid for trains driving towards the disrupted section, further provisions are still required for the remaining trains across the affected lines.

A detailed consideration of the trains' driving directions, their actual position within the network and their status within the DRP operating concept have already been discussed in subsection 7.3. The train category clusters, as part of the DRP set-up module, once again becomes a valuable tool.

Trains clustered within the Green and Yellow categories do not require further detail as their investigation order follows the guidelines discussed above. However, trains clustered in the line's Green+ category (marked in grey in figure 9.2) are driving away from the disruption and, therefore, cannot follow these same guidelines. In view of the fact that these trains can only be handled as part of the disruption-management process once they have concluded their current service, their investigation order is assigned according to their projected arrival time at their end station. As such, regardless of this timeframe, the investigation order of trains in the Green+ category always initiates after the last train in the Yellow or Green category per side has been appointed (if applicable).

Furthermore, trains in the parking locations that have immediate service availability and have been identified in the previous module must also be appointed an investigation order (see subsection 8.4.3). The investigation order assigned to these trains requires a closer deliberation. One plausible option could be assigning the park trains an investigation order together with Green+ trains, utilizing their projected departure from the parking locations as a temporal reference. However, it is difficult to ascertain with precision when this departure time will take place, as this may vary significantly in correspondence with the communication process to the relevant staff members and the line to which they are assigned (see subsection 6.3.2). Therefore, parked trains can be assigned investigation orders following the last train in the Green+ category.

Ultimately, trains clustered in the Red+ category have not been afforded consideration thus far; nonetheless, their ability to be potentially re-introduced in the system has been acknowledged during the clustering process. Therefore, all trains in the Red+ cluster can be assigned an investigation order that follows those of the last train in the parking cluster. Assigning an investigation order to Red+ trains must be conducted by ensuring their actual ability to keep driving throughout the network, which must be corroborated during the implementation of the system.

With the investigation order of the trains established, the actual development of the PVSCS can begin with the first train in the investigation order (i.e. $T_{l_s,1}$). In case the network is divided into two different sides, this process is conducted for each side individually.

9.4. Isolating Potential Handling Alternatives for an Investigated Train

The handling alternatives refer to a combination of the potential conflict solution alternatives established during the classification of the line-specific conflicts for the line of an investigated train $T_{l_s,i}$, its accessible infrastructural elements and the transition train services that may be appointed to adjust its circulation plan (i.e. potential transition train services, see subsection 3.6.2). The process of isolating the handling alternatives to develop the different PVSCS (see subsection 9.3) is detailed throughout this subsection.

To isolate the potential handling alternatives, this subsection incorporates the train's actual location, the DRP operating concept of the train's line, which includes all train services foreseen to be serviced during the disruption as detailed in subsection 5.3, the relevant infrastructural information flagged in subsection 7.3 and the sorted list of line-specific conflicts generated throughout section 8. By isolating the potential handling alternatives, the development of the PVSCS can secure an overview of the actual situation of each train within the disrupted network.

Initially, to lay the groundwork for the development of the PVSCS, this subsection discusses the process of isolating the accessible infrastructural elements in view of the actual location of an investigated train within the network at the time of the disruption (see subsection 9.4.1). Thereafter, the process of establishing a shortlist of elemental conflict solution alternatives for an investigated train is discussed in detail (see subsection 9.4.2). Later, a shortlist of all transition train services that can be appointed to an investigated train for the adjustment of its circulation plan is discussed (see subsection 9.4.3).

9.4.1. Isolating Accessible Infrastructural Elements

Recognizing the infrastructural elements that can be accessed by an investigated train $T_{l_s,i}$, allows establishing the different routing possibilities during the transitioning to stable operations. An overall identification of relevant infrastructural elements has already been conducted in subsection 7.3, distinguishing between first-order and second-order infrastructural elements. These elements have been identified as relevant for each of the affected lines, and they provide a proficient starting point for isolating the accessible infrastructural elements for an investigated train.

Before the infrastructural elements can be isolated, it is necessary to establish an understanding of what actually constitutes an accessible infrastructural element. Such a definition must draw from the requirements and overall approach of the dynamic DRP deployment system (see subsections 3.4.2 and 3.5.2), particularly regarding the ability to transitioning the train line towards stable operations, as discussed by the requirements detailed in subsection 9.2.1.

At the outset, depending on the infrastructural layout and the magnitude of the disruption, a train can potentially access any available infrastructural element in the commuter railway network that is compatible with its technical and operational requirements. However, to prioritize the most straightforward routes for transitioning to stable operations for the development of the PVSCS, an accessible infrastructural element is any element that can be accessed by a train without the need to change its driving direction.

All elements fulfilling the above-established definition can be considered as being accessible for an investigated train. However, since the DRP relevant infrastructural elements for an investigated train's line are already flagged (see subsection 7.3.1) and the line-specific conflicts identified, a much more detailed overview of the accessible infrastructural elements in the network can be acquired. A more detailed understanding of an accessible infrastructural element would ensure that only the most purposeful elements for the DRP operating concept and the disruption-management are isolated for an investigated train. Under these conditions, the infrastructural elements for an investigated train $T_{l_s,i}$ are further detailed in the seven cases below:

- i) *For Yellow trains*: as a general approach, the original understanding is not altered, as this would allow exploring all possibilities (i.e. first-order and second-order infrastructural elements) for these trains.
- ii) *For Green trains*: the original understanding is not altered since it is likely that for these trains, a relevant alternative for the transitioning of its line to stable operations can be found outside the first-order DRP relevant infrastructural elements.
- iii) *For Green+ trains*: the original understanding can be altered slightly to recognize only the first-order accessible infrastructural elements and elements that allow for the transfer of the train to the opposite side.
- iv) *For Trains Being Incorporated in the Network*: depending on the affected line to which a parked train is assigned, and its position in the network in relation to the line's DRP relevant infrastructural elements, a parked train can be recognized as to be part of the Green, Green+ or Yellow categories. Therefore, the accessible elements for parked trains are those, which were detailed in the three previous points.
- v) *For Red+ Trains*: the original definition is altered as for Green+ trains since the capability of Red+ to reach their end station must be verified during the clustering process (see subsection 7.3.2).

vi) *Parking Locations*: after conventional or unconventional parking locations have been established for the line and side (see subsection 8.4.3), potential parking locations for an investigated train must be isolated. Aligned with the approach discussed in subsection 6.3.3, the original understanding can be maintained. Thus, all parking locations that can be accessed without the need to change the train's driving direction are immediately isolated. Once the last train of a specific line and side (if applicable) has been investigated, it must be verified that each parking location has been isolated as an infrastructural element for at least as many trains as established during the exploration in subsection 8.4.3.

If this is not the case, specific trains must be chosen and have these parking locations isolated as infrastructural elements. As explained in subsection 2.3.3 and in subsection 6.3.3, the faster trains are removed from the network, the faster it is able to reach stability. Aligned with the approach discussed in subsection 6.3.3, the remaining parking locations are isolated in correspondence to the driving distance of the trains vis-à-vis their actual location in the network (see subsection 5.4). Trains with the shortest driving distance to the parking location have it included in their isolated infrastructural elements.

vii) *For all Trains*: the original definition can be modified according to support further system constraints. On the one hand, to support crew replacement purposes, an investigated train can further reduce the number of accessible infrastructural elements. This would be the case if a train had to reach a particular station in the network to replace its crewmembers (see subsection 3.4.2). On the other hand, an alternative element can be manually introduced or removed so as to allow for the better handling of the situation; for example, the introduction of a deviation towards a major station outside the commuter railway network, or the removal of certain unavailable elements due to the existence of maintenance or construction works.

Ultimately, depending on the available computational effort, each of the above-detailed clusters can be further limited to consider only infrastructural elements that have been flagged as first-order or that have been identified offline (see subsection 7.3).

9.4.2. Isolating the Potential Conflict Solution Alternatives

As evidenced throughout section 8, the disruption impacts each of the lines differently, and they each hold their own potential to implement their DRP operating concept successfully. The process of isolating potential conflict solution alternatives brings the line-specific evaluation to the vehicle-specific operational level by allowing to identify the best possible dispatching measures that can be assigned to every train in correspondence to their accessible infrastructural elements. This subsection provides a close account of the process of establishing the potential conflict solution alternatives for an investigated train $T_{l_s,i}$ so as to address its already classified line-specific conflicts.

At the outset, the classified and sorted line-specific conflict list (see subsection 8.5) contains the most relevant conflict solution alternatives that must be implemented to address the operating situation of an investigated train's line. Having already isolated the accessible infrastructure elements for train $T_{l_s,i}$ in subsection 9.4.1, the elemental conflict solutions can be made specifically for every train. This must be conducted separately for each of the two line-specific conflict types, namely, vehicle availability and reachability conflicts (while respecting their order within the line-specific conflict list).

Initially, as detailed in subsection 8.5, vehicle availability conflicts are recognized first, since they remain at the top of the list and are specific to the line and side (if applicable) of an investigated train. The already classified vehicle availability conflict immediately reveals the nature of the conflict for the affected line (i.e. lack or surplus of trains) and the elemental conflict solution alternatives required to deal with conflicting vehicles. The isolation process starts by comparing the elemental conflict solution alternatives with the already isolated infrastructural elements for an investigated train $T_{l_s,i}$. As a result, the measures are included in a shortlist of conflict solution alternatives for the investigated train. This process is conducted with respect to the nature of the vehicle availability conflicts for an investigated train's line and side (if applicable) and the order in which they have been classified (see figures 8.4 and 8.5), as follows:

- i) *For lines l_s with a lack of trains:* the classified conflict would correspond to one of the nineteen classes detailed in 8.4.3, which can be addressed through the five different elemental conflict solution alternatives presented in 6.4.1. In this case, since the measures have either been already considered (i.e. parking) or dependent on other lines with a surplus of vehicles (i.e. exchange of train between corresponding lines), the only measure that can be shortlisted at the vehicle-specific level is the decoupling of a train, as ascertained by the conflict class. If the decoupling of trains is observed within conflict class and the train $T_{l_s,i}$ is part of the trains considered during the evaluation process (see subsection 8.4.3), the measure can be immediately shortlisted. In such a situation, a provisional investigation order can be assigned (by need) to the decoupled unit ($T_{l_s,i'}$).
- ii) *For lines l_s with a surplus of trains:* the classified conflict would correspond to one of the twenty-two different classes detailed in 8.4.3, which can be addressed through the four different elemental conflict solution alternatives presented in 6.4.1. Depending on the conflict class, four measures can be shortlisted.
 - First, the exchange of trains between corresponding lines can be immediately shortlisted regardless of the infrastructural elements that are accessible to the investigated train.
 - Second, the parking of trains is shortlisted if there are any parking locations that have been isolated in for the investigated train (see subsection 9.4.1).
 - Third, a train transfer can only be shortlisted if the investigated train has a deviation point to the opposite side as one of its isolated infrastructural elements.
 - Fourth, as with the decoupling, the coupling of trains can be shortlisted regardless of the infrastructural elements that are accessible to the investigated train, and if the investigated train is considered during the evaluation process (see subsection 8.4.3). As discussed in subsection 8.4.3, all coupling candidates have already been shortlisted for the train depending on the line's need and the driving direction. If an investigated train has already been considered for coupling during the development of the PVSCS of previous trains (in previous iterations of the general approach), the measure should not be considered again.

Next, in the line's list of line-specific conflicts, the reachability conflicts remain respective to an investigated train's line and side (if applicable). The already classified reachability conflicts are listed in chronological order and distinguish between the conflicting train services and the elemental conflict solution alternatives required to address reachability conflicts. While the solution alternatives are partly contingent on the shortlisted elemental conflict solution

alternatives for vehicle availability conflicts (see subsection 6.4), these are complemented by the independent conflict solution alternatives, as discussed in subsection 8.4.5.

As a result, the independent solution alternatives to address reachability conflicts may be introduced as a complement to the measures already shortlisted to address vehicle availability conflicts. In addition to the conflict resolution alternatives, the identified conflicting train services Trc_{l_s} can be assigned to an investigated train $T_{l_s,i}$ as potential train services in the opposite direction. It must be noted that due to their location and driving direction (see subsection 8.4.5), trains in the Green+ category cannot be utilized to address reachability conflicts; thus, the conflicting train services are not available for these trains. The process of expanding the shortlist of conflict solution alternatives is also conducted with respect to the nature of vehicle availability conflicts of an investigated train's line, as follows:

- i) *For lines l_s with a lack of trains:* the classified conflict would correspond to one of the four different classes detailed in 8.4.4. In this case, there is only one measure that can be added to the existing shortlist. If the train has immediate access to a first or second-order turning station, the early turning of the train is included in the shortlist, acknowledging the conflicting services and matrix of turn residuals $TR_{Trc_{l_s}}$ for the affected line (see subsection 8.4.5).
- ii) *For lines l_s with a surplus of trains:* the classified conflict corresponds to one of the four different classes detailed in 8.4.4. Depending on the already shortlisted measures for vehicle availability conflicts, these can be complemented, and one measure can independently be added to the existing shortlist for an investigated train.
 - Firstly, if the train has immediate access to a first or second-order turning station, the early turning (turning) of the train is included in the shortlist, acknowledging the conflicting train services and matrix of turn residuals $TR_{Trc_{l_s}}$ for the affected line.
 - Secondly, if the exchange of trains between corresponding lines has been shortlisted as a solution alternative to address the vehicle availability conflicts, the conflicting train services and matrix of turn residuals $TR_{Trc_{l_s}}$ for the corresponding line(s) l_s^c with the verified lack of trains must also be recognized.
 - Thirdly, if the transfer of the train has been shortlisted, the reachability conflicts and DRP operating concept of the line's opposite side must be also be recognized.

It is important to note that the total cancellation of a train service, as detailed in subsection 6.3.5, cannot be shortlisted as a conflict solution alternative. This is due to the fact that at this point, it is not possible to ascertain which train services need to be cancelled. This information can only be derived once the different PVSCS of the trains are combined. Therefore, the development of the PVSCS needs to cover the transition of an investigated train to the maximum number of possible train services so as to provide a wide range of alternatives for the adjustment of circulation plans.

9.4.3. Isolating Potential Transition Train Services

At the beginning of the disruption-management an investigated train $T_{l_s,i}$ has assigned a current train service and a circulation plan (see subsection 5.3). However, the capability of the train to strictly follow its circulation plan is affected by the disruption. Supporting the adjustment of the circulation plans and complementing the development of the PVSCS, a shortlist of potential

transition train services is established for each of the investigated trains. This subsection discusses the process of isolating potential transition train services for an evaluated train $T_{l_s,i}$.

As discussed in subsection 2.3, to address the disrupted operations, particularly in case of a complete blockage, trains may be assigned different train services to the ones detailed in their original circulation plans. Listing the train services that can be utilized to adjust the circulation plan of an investigated train would support the ability of the dynamic DRP deployment system to fulfill its requirements, as discussed in subsection 3.5.2 (see subsection 3.4.2).

At the core of the adjustment of a train's circulation plan, the DRP operating concept of the investigated train's line (see subsection 5.3.2) provides with a record of potential train services to be serviced during the disruption (see subsection 9.2.1). Additionally, the conflicting train services already identified as reachability conflicts for the investigated line also form part of the potential train services that may be serviced by an investigated train (see subsection 9.4.2). Consequently, any train service that is not being currently serviced by another train or has not been cancelled by the DRP operating concept can be potentially assigned to an investigated train $T_{l_s,i}$ in order to adjust its circulation plan.

Furthermore, as discussed throughout subsection 6.3, the potential line-specific conflict solution alternatives that may be assigned to an investigated train would also impose different requirements for the adjustment of its circulation plan. The solution approach may require selecting one or more transition train services to appoint to an investigated train and a specific location in the network. Thus, the establishment of potential transition train services also entails considering the implementation of the line-specific conflict solution alternatives (e.g. coupling, decoupling or turning stations) at the different nodes in the network where the potential line-specific elemental conflict solutions anticipate a transition between train services.

Multiple approaches may be put forward to determine the potential transition train service that can be appointed to a particular train in order to modify its circulation plan. Depending on the type of traffic being handled (i.e. the service interval in the cyclic schedule) an one approach may focus on assigning the train, the next possible train service scheduled to depart from the station where the circulation plan needs to be modified so that the transition between train services guarantees that a positive turn has been generated (see subsection 3.7.2). However, the short service intervals and limited overall journey distance of commuter railway operations allow more flexible handling of the adjustment of the circulation plan. Therefore, by focusing the adjustment of the circulation plan on the selection of potential transition train services that would engender only positive turns after the transition, the exploration of different solution alternatives would be highly limited. Consequently, a different approach is required to handle the adjustment of the circulation plan, as required for the dynamic DRP deployment system in subsection 3.4.

Just as with the isolation of infrastructural elements for an investigated train $T_{l_s,i}$, a range of potential transition train services can be established to define the transition train services that can be utilized to adjust its circulation plan. Establishing a range of potential transition train services would have an effect on the number of different PVSCS that can be generated for every train and the probability of inducing further service conflicts between train services of the same line. Therefore, utilizing a range of potential transition train services would allow considering more than one alternative, which may also be adjusted depending on the implementing field to accommodate the available computational effort.

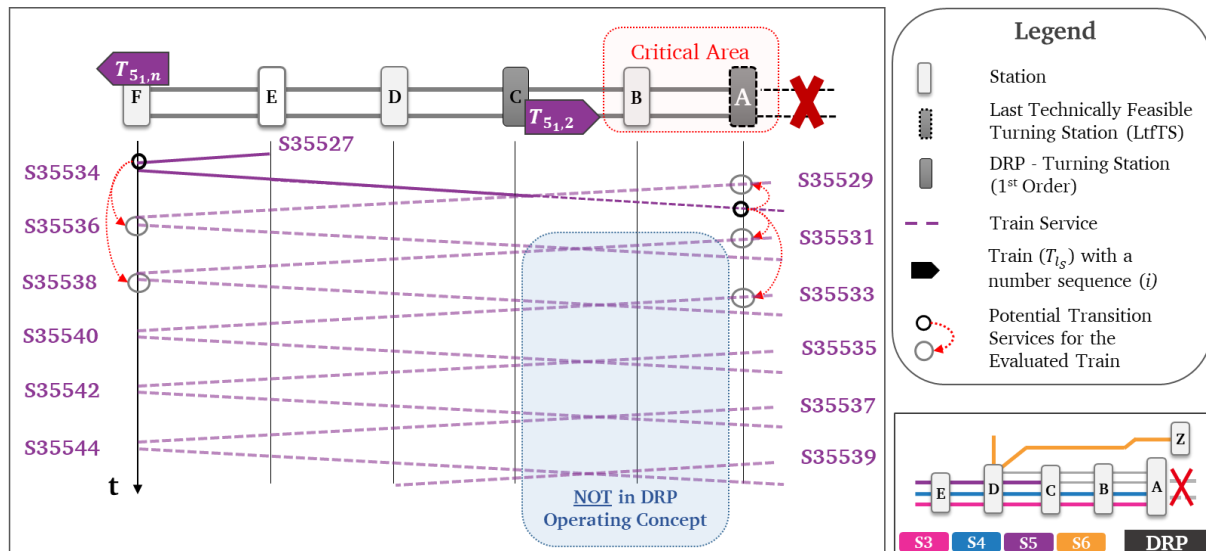

Figure 9.3 General example for Isolating Potential Transition Train Services for a train (by author)

As it has been done during the establishment of the elemental conflict solution alternatives, the range of potential transition train services for the investigated trains may be established according to their train category:

- i) *For Yellow and Green trains:* since these trains are driving towards the disrupted section at the moment the system is being deployed, they must be appointed with the most robust or widest range of potential transition measures. This would allow developing different PVSCS for trains, whose handling, is particularly relevant for the transitioning of the network to stable operations. Thus, to establish the range of potential transition train services, a specific number of prior and/or subsequent train services at the station where the transition between train services is taking place (e.g. at coupling, decoupling or turning stations) must be considered. The range may include one or more prior and/or subsequent train services, which are not being serviced by other trains of the respective line and side (if applicable), and are foreseen in the DRP operating concept, as depicted in figure 9.3. In the example presented in figure 9.3, the investigated train $T_{5,2}$ (Yellow) has assigned as current train service, the number S35534. In this case, the range of the potential transition train services is adjusted to include two prior and two subsequent train services at the LtTTS as the train's turning station. As a result, an investigated train $T_{5,2}$ would have as potential transition services, the train service numbers: S35529, S35531, S35533, and S35535. Nonetheless, in this example, train service S35529 is already being serviced by another train; thus, it cannot be considered. Furthermore, if any of these services have already been listed as a reachability conflict, they must be left aside, since they have already been acknowledged in 9.4.2.

In order to consider an effective range of alternatives for the adjustment of the circulation plan of Green and Yellow trains, the handling of examples as the one depicted in figure 9.3 has highlighted the benefit of considering a range of two prior and two subsequent train services. If the range is reduced, a potentially relevant solution may be omitted. On the other hand, if the range is expanded, the exploration would become exhaustive, but it would generate multiple trivial solutions. While the range can be adjusted by the user to better support the computational effort available, the standard approach of the dynamic

DRP deployment system for Yellow and Green trains foresees the handling of two prior and two subsequent train services.

Ultimately, it must be noticed that if an exchange of trains between lines has been shortlisted as a potential conflict solution alternative for an investigated train, the train services in the corresponding line(s) must also be included in the list of potential train services for the transition (see subsection 3.6.2).

- ii) *For Green+ and Red+ trains:* these trains can immediately transition towards the train service detailed in their circulation plans if and only if the train service is considered in their line's DRP operating concept. If the train service is not supported in the DRP operating concept of the respective line and side (if applicable), the immediately subsequent train service in the DRP operating concept scheduled to depart from the station must be considered. However, since Green and Yellow trains can be appointed more than one potential transition train service, Green+ trains must be able to cope with the possibility that a train service in its circulation plan has already been assigned. Therefore, at the end station, a range of up to two subsequent train services supported by the investigated train's line DRP operating concept can be listed as potential transition services. Figure 9.3 depicts an example in which an evaluated train $T_{5,1,n}$ (Green+) reached its end station and has assigned as current train service, the number S35529. Following the above-detailed approach, the train has as its set of potential transition services, the train service numbers: S35536 and S35538.
- iii) *For Parked Trains:* depending on the affected line to which a parked train is assigned and its position in the network in relation to the line's DRP operating concept, a parked train can be clustered in the Green, Green+ or Yellow categories, and thus, follow the above-explained guidelines.

Each of the potential train services being listed would replace and update the circulation plan of an investigated train. This means that during the development of the PVSCS different circulation alternatives between train services can be assigned to every train, depending on the train services selected from the list.

9.4.4. Summary

By compiling information derived within this subsection the three basic components (i.e. handling alternatives) for the development of the different PVSCS of an investigated train have been established. The isolation of these elements that correspond to each of the three basic components of every train (i.e. accessible infrastructural elements, line-specific elemental conflicts solutions, and potential train services) lays the foundation for the adjustment of both schedule and circulation plans as part of the dynamic DRP deployment system.

The elements corresponding to each of the three basic components are isolated in three individual lists for every investigated train abiding by the process established by the structured approach detailed in subsection 9.2.2. As discussed in subsection 3.5.2 and foreseen in the modules structured approach, the selection and combination of the elements in the three resulting lists constitute the basis for the development of every PVSCS of a given train.

The information contained in each one of the three lists can be summarized as:

- i) *The list of accessible infrastructural elements:* contains all isolated infrastructural elements for an investigated train, as discussed in subsection 9.4.1, including parking locations for

the train's line and side as required by the classified vehicle availability conflict (see subsection 8.4.3). As such, the list includes a range of infrastructural elements within any of the six alternatives listed below:

- First-order Turning Stations
- Second-order Turning Stations
- Last Technically Feasible Turning Station
- First-order Deviation Points
- Second-order Deviation Points
- Conventional and Unconventional Parking Locations

ii) *The shortlisted line-specific potential conflict solution or dispatching measures*: contains all the conflict solution alternatives that may be implemented to the investigated trains vis-à-vis the potential solution alternatives identified subsection 9.4.2 for the respective line. As such, the list encompasses any of the five elemental conflict solution alternatives listed below:

- Park Train (PT)
- Early Turn Train (ETT)
- Transfer Train (TT)
- Couple Train (CT)
- Decouple Train (DCT)

iii) *The list of potential transition train services to adjust the circulation plan*: contains all potential transition train services for an investigated train as established in subsection 9.4.3. The list encompasses a range of potential transition services obtained from two specific sources:

- Services in the reachability conflict list
- Services within the established interval as part of the DRP operating concept

It must be noted that the list may also include train service for the corresponding line(s), as discussed in subsection 9.4.3.

All in all, the elements isolated within this subsection constitute the range of all handling possibilities to be explored at the vehicle-specific level towards transitioning the disrupted network to stable operations. Furthermore, the elements in each of the lists constitute the foundation for the development of as many PVSCS as possible for every investigated train (see subsection 3.5.2). In the following subsection, the elements are selected and utilized to develop the line-specific conflict resolution alternatives (i.e. PVSCS).

9.5. Development of the PVSCS

The development of the PVSCS for an investigated train $T_{l,s,i}$ is discussed in detail throughout this subsection. The development process of each of the PVSCS is advanced by considering the system's overall approach discussed in subsection 3.5.2, the already established requirements and limitation of the module detailed in subsection 9.2.1 and the structured approach depicted in figure 9.1.

As discussed in subsection 9.2.2, the development of the PVSCS must start with a selection of the elements in the lists of the three basic components that have been isolated for the investigated train (see subsection 9.4). Furthermore, as discussed in subsection 3.5.2 and 9.2.1, the development of the different PVSCS must be conducted through a right-shift rescheduling approach while considering an empty network (i.e. disregarding the interaction of the investigated

train with other vehicles). Additionally, discussed in subsection 9.2.1, the development process must also incorporate the solution approach of each of the predefined conflict solution alternatives detailed in subsection 6.3 (see subsection 9.2.1). As a result, every PVSCS that is generated for an investigated train may contain:

- A line-specific conflict solution(s) to address an existing line-specific conflict
- A specific route and the spatiotemporal information throughout the infrastructural elements (i.e. route within the nodes, arrival and departure times) considering an empty network and abiding by the chosen line-specific conflict-solutions
- A set of transition train services adjusting the circulation plan for every vehicle or vehicle composition constituting a train (see subsection 3.6.2), including the potential involvement with other trains due to coupling or decoupling

More explicitly, as discussed in subsection 3.7.2, a PVSCS is a collection of spatiotemporal aspects, which support the movement of a train throughout the network guided by the implementation of the elemental conflict solutions and complemented by train services in a circulation plan. Taking into account the infrastructural representation used in the dynamic DRP deployment system (see subsection 5.1), a single train PVSCS consists of a string of nodes (i.e. stations stopping points and/or junctions) and links in the enhanced macroscopic infrastructural model (see subsection 5.1), and the specific route taken by the train throughout each node. This information is complemented by the arrival and the departure times of the train from each of the elements.

The development of the PVSCS aligned with the module's structured approach can be summarized in the following steps. First, the starting and objective nodes for the investigated train are established by combining the actual location of a train with the potential conflict solution, as well as the accessible infrastructural elements that have been selected. Second, the string of nodes connecting the starting and objective nodes as well as spatiotemporal information throughout the infrastructural elements (i.e. route within the nodes, arrival and departure times) is established. As discussed in the system's general approach (see subsection 3.5.2), the right-shift rescheduling approach is employed for this purpose. The approach allows to put together a sequence of nodes and links, determines the train's route along with these elements, and reveals temporal information detailing the train's movement throughout the route. The temporal information is derived by taking into consideration any transition between train services that are required to modify the circulation plan of the train, according to the transition train services that have been selected from the isolated list.

As discussed in subsection 9.2.1, since the right-shift rescheduling approach is not aligned with its implementation within a planned disruption-management approach (see subsection 2.3.2) a particular modification would need to be introduced so as to make the existing approach compatible with the dynamic DRP deployment system. Therefore, the necessary modifications would need to be derived before the approach can be utilized for the development of the PVSCS.

In the following subsection 9.5.1, the modifications that need to be introduced to the right-shift rescheduling approach to make it compatible with the PVSCS development are identified and introduced. Later, in subsection 9.5.2, with a compatible approach, the actual development process of the different PVSCS, including the selection of the isolated elements from the lists of the three basic components, is thoroughly explored and discussed.

9.5.1. Modified Right-Shift Rescheduling Approach

The right-shift rescheduling approach was selected over more sophisticated approaches and it is based on the assumption that the best possible solutions will be closely related to the original schedule (see subsection 3.5.2). The approach incorporates the spatiotemporal information from the original schedule (e.g. allocation of tracks or platform tracks and arrival times) to derive an initial solution for the adjustment of a train's schedule. In the structured approach (see subsection 9.2.2), these principles are used to incorporate the necessary spatiotemporal information during the development of the different PVSCS for an investigated train $T_{l_s,i}$. However, since the approach was developed for its use within ad-hoc disruption-management, it is not compatible with planned disruption-management approaches (see subsection 2.3.2 and 2.3.3). This subsection details the necessary modifications to be introduced in the existing approach making it compatible with the dynamic DRP deployment system.

Overall, the right-shift rescheduling ascertains an initial solution of poor quality by maintaining the original schedule; thus, forbidding unplanned stops, maintaining the allocation of routes and platform tracks as well as the order of trains in links and nodes (see subsection 2.3.2). While the core principles of the right-shift rescheduling approach are compatible with this module's structured approach, the existence of a line-specific DRP operating concept must still be supported. Therefore, the right-shift rescheduling approach should not only be aligned with its implementation within a disruption but also compatible with the DRP operating concept respective to the investigated train's line and its already established train's category (see section 7).

To address the identified problem, the right shift rescheduling is implemented as a baseline-PVSCS for every investigated train. The information from the original schedule allows ascertaining the required spatiotemporal information in a baseline-PVSCS, over which the different PVSCS can be generated. In addition, the baseline-PVSCS also adjusts the spatiotemporal information in concordance to the DRP operating concept respective to the investigated train's line and its category.

As a result, to ensure that the baseline-PVSCS is compatible with the disrupted circumstances and the actual condition of the train $T_{l_s,i}$ vis-à-vis its line's DRP operating concept, it is derived in parallel with the train's evaluated category. Under this consideration, the baseline-PVSCS for train $T_{l_s,i}$ is derived as within one of four cases:

- i) *For Yellow trains:* the baseline-PVSCS reflects the spatiotemporal information as found in the train's original schedule, with one exception. For passenger comfort, at nodes where a train transitions from one train service to the next, as detailed by the transition train services chosen for the adjustment of its circulation plan (i.e. turning stations, coupling or decoupling stations), the routes and platform tracks are assigned according to the spatiotemporal information of the train service product of the transition between train services. For example, at turning stations, the platform track scheduled for the train service in the opposite direction (i.e. transition train service – see subsection 3.7.2) prevails in the baseline-PVSCS. Therefore, the route within this node must allow the train to reach the platform track or the platform track group scheduled for the transition train service. If this platform track or platform track group is not accessible from the train's entrance route to the node, a platform track or platform track group is selected such that the train is able to follow the route in the scheduled of the transition train service. Additionally, the temporal

information from the schedule must be modified according to the introduced spatial changes.

- ii) *For Green+, Green and Red+ trains:* the baseline-PVSCS reflects the spatiotemporal information found in the train's original schedule, however, it must also include all of the changes required by its line's DRP operating concept (see subsection 5.3.2). If the DRP operating program fails to provide explicit detail for routes within nodes where the transitions between train services are foreseen to take place during the disruption (e.g. DRP turning stations), the necessary changes due to passenger comfort discussed for the Yellow category must be supported.
- iii) *For Parked Trains:* depending on the affected line to which a parked train is assigned, and its position in the network in relation to the line's DRP operating concept, a parked train can be clustered in the Green, Green+ or Yellow categories. Therefore, the baseline-PVSCS is introduced correspondingly, as detailed in the two previous points.

Since the baseline-PVSCS is, for its most part, derived with the information contained within the original schedule, there are certain limits to its use throughout all the accessible infrastructural elements that can be reached by a given train (see subsection 9.4.1). This is especially the case when trying to ascertain the spatiotemporal information for a baseline-PVSCS throughout the portions of the network that lay outside the train's original schedule. For example, in case the objective node is located outside the commuter railway network and linked through a second-order deviation path, the baseline-PVSCS should be able to guide the development of the PVSCS by establishing the spatiotemporal information beyond the routes established in the original schedule of the train. Therefore, it is necessary to adapt the existing approach so as to handle this limitation.

The rerouting methods discussed in subsection 6.3.4 can be employed to tackle this specific task. However, a much more general and simpler method has been proposed in Oetting et al. (2011), where train itineraries are generated directly based on the attributes of the infrastructural elements in the enhanced macroscopic infrastructure model. This approach relies on the journey times and attributed to the infrastructural elements as a function of the model train of an investigated train (see subsection 3.6.2).

Within nodes not included in the original schedule, especially throughout stations outside the commuter railway network, the selection of routes and platform tracks must be aligned with the rest of the baseline-PVSCS, the driving direction and the operational and technical qualities respective to the model train. Furthermore, in cases where turns are to be conducted on stations outside the commuter railway network, the selection of the platform track must take close consideration on the local operational circumstances at the station (e.g. type of traffic handled by at the station). As detailed in subsection 7.3, the utilization of elements in and around these nodes can be established offline for every specific DRP operating concept or by the use of the enhanced flagging process.

Since it does not seek to explore different routing options and is only applicable if the infrastructural model contains the required information, the above-discussed approach is able to handle the complexity of the routing problem. This approach can be directly implemented, provided that the developed PVSCS will be fixed in later stages, the deviation paths have already been isolated for an investigated train, and the infrastructure model has the required information (see subsection 5.1). Therefore, in the portions of the network not included in the baseline-PVSCS as detailed above, the spatiotemporal information across the nodes and links is determined from

the infrastructure model by utilizing the immediately available infrastructural elements that are compatible with the model train of the investigated train and utilizing the shortest route towards its foresaw end station. Additionally, if the information from other railway traffic is available (see seduction 5.4.2), the route that may have the least influence on the operating situation (i.e. generate occupancy conflicts) may also be ascertained.

The necessary modifications to be included in the right-shift rescheduling approach have been identified and discussed throughout this subsection. All in all, two general modifications to the existing approach have been established so as to make it compatible with the module's requirements. On the one hand, deriving a baseline-PVSCS that takes into consideration not only the spatiotemporal information of the original schedule but also the DRP operating concept of the investigated train's line and the category in which the investigated train has been clustered (see section 7). On the other hand, a framework supporting the establishment of the spatiotemporal information throughout portions of the network not supported by the original schedule. With the modification to the right-shift rescheduling approach identified and addressed, the PVSCS can now be developed.

9.5.2. Development of the PVSCS

As depicted in figure 9.1, the PVSCS for an evaluated train $T_{l_s,i}$ are developed one at a time by systematically combining different elements from the handling alternatives isolated as discussed in subsection 9.4 and guided by the baseline-PVSCS introduced in subsection 9.5.1. As discussed in subsection 9.2.2, the tasks to be fulfilled in the PVSCS development process are: select and combine elements from the three isolated lists (supported by the information available from already developed and verified PVSCS), and ultimately, generate a PVSCS using the baseline-PVSCS. This subsection provides an overview of the process to develop the different PVSCS for an investigated train, as established by the module's structured approach (see figure 9.1).

Aligned with the structured approach, the development of a PVSCS for an investigated train is performed in three steps.

1. The selection and combination of specific elements from the three handling alternatives isolated in subsection 9.4 are conducted. As discussed in subsection 9.2.1, the selection process must incorporate information from the operational verification of the already developed PVSCS.
2. The establishment of the developmental constraints is carried out. This allows ascertaining the framework within which the PVSCS must be developed. The constraints are established in overall by taking into consideration the elements selected from the lists and the solution approaches discussed in subsection 6.3.
3. The actual development of the PVSCS is carried out. The development of the PVSCS is steered by the baseline-PVSCS while abiding by the established constraints. The constraints allow incorporating the necessary modifications to the spatiotemporal qualities and the adjusted circulation plan of the PVSCS.

Furthermore, the development process does not require conducting any further analysis on the developed PVSCS, since the verification of its technical and operational feasibility is conducted in subsequent steps as established by the structured approach in subsection 9.2. The following subtitles provide an overview of the three septs needed to develop a PVSCS for an investigated train $T_{l_s,i}$.

Selection and Combination of Elements in the List

The selection of the elements in the three lists of isolated basic components is the first step in the development of a PVSCS. The selection of the elements in the list would allow establishing one of multiple handling alternatives that can be allocated to the train in order to resolve the line-specific conflicts of its line. As discussed in subsection 9.2.2, in order to make the selection process of elements much more efficient and effective, the selection and combination are supported by incorporating information from the verification of already developed PVSCS, as depicted in figure 9.1. Hence, it is expected that once a PVSCS is developed, information from its verification guides the selection of the subsequent elements from the lists of isolated elements. This subtitle derives the specific process supporting the selection and combination of the elements from the three lists of isolated basic components.

Since the selection of elements is supported by information from already verified PVSCS, the elements being selected at the beginning of the development are particularly important. However, it is still necessary to establish which of the elements in the list should be selected first. For this purpose, it would be beneficial to consider the way in which the elements in the different lists have been isolated.

- The accessible infrastructural elements have been isolated, taking into account the actual location of the investigated train and its ability to reach a given infrastructural element without changing its driving direction (see subsection 9.4.1).
- The potential conflict solution alternatives have been isolated on the basis of the elemental conflict solutions established during the classification of the line-specific conflict per line and side (if applicable) and the infrastructural elements accessible to an investigated train (see subsection 9.4.2). Furthermore, it must be considered that potential conflict solution alternatives have been classified and listed according to the hierarchical structure introduced in subsection 6.4 (see figures 8.4 and 8.5).
- The potential transition train services have been isolated by taking into consideration the train's driving direction, the train services generating a reachability conflict, and a pre-established range of alternatives that can be modified according to the computational effort available (see subsection 9.4.3).

Since the line-specific potential conflict solution alternatives for the investigated train have been isolated by taking into consideration the accessible infrastructural elements, the order in which these elements are selected is of no critical importance, as they should already be compatible with each other. On the other hand, the transition train services that can be selected are highly dependent on the potential conflict solution alternatives that may be selected for the investigated train. This is because a conflict solution alternative would define the transition train services that can be considered (e.g. early turn as opposed to the removal of the train to a parking location). Additionally, the location (i.e. accessible infrastructural element) that is chosen to perform the transition between train services would induce a different effect on the operating situation. This has been evidenced during the establishment of the turn residual in subsection 8.4.5 (e.g. negative turn, positive turn - see subsections 3.6.2 and 3.7.2).

Taking into account the interdependence between the isolated elements explained above, it is possible to derive the following considerations:

- i) The line-specific potential conflict solution alternatives that are selected have a direct influence on the transition train service that can be selected.

-
- ii) The location in the network where the transition between train services is foreseen to be conducted would greatly influence the operating situation of the railway network. Here is where the information from the operational verification of already verified PVSCS would become relevant as it would allow the system to narrow down suitable locations in the network.

With the considerations derived above, the selection and combination are envisioned as a nested process, which is conducted systematically and based on the chosen conflict solution alternative. The selection and combination of the elements are conducted as a nested approach as it would allow to incorporate and process the information from the operational verification process (see subsection 9.7). This entails that the selection starts by selecting a potential conflict solution alternative, then a transition service and finally, an accessible infrastructural element. The selection starts with a potential conflict solution alternative due to consideration *i*) and because the compatibility between the selected measure and the accessible infrastructural element has been already considered during the isolation. The selection continues to choose a transition train service and the accessible infrastructural elements by incorporating the information from subsection 9.7, following consideration *ii*).

As a result, the selection processes foresees that once a potential conflict solution alternative is selected, the subsequent measure in the list may only be selected after all transition services are considered. In the same way, the next transition service in the list may only be considered once all accessible infrastructure elements are considered.

The selection process follows the three steps detailed below:

1. *Selecting a conflict solution alternative*: the elemental conflict solution alternatives in the isolated list are selected and combined one by one (see subsection 9.4.2).
The selection starts with the first shortlisted measure, and before it is combined with any other measure in the list, it must be paired with all transition train services in the shortlist (step 2). The selection must abide with the order in which the measures have been listed. The listed order is compatible with the hierarchical structure utilized for the classification of the line-specific conflicts (see subsection 8.4.3).
The next measure in the list can only be selected once the first measure has been combined with all measures in the list. A measure can not be combined twice with other measures, and the combinations must follow the combinability guidelines detailed in table 6.3.14.
The only exception is in the case where the selected measure entails the parking of train without the need to change its driving direction. In this case, no transition train service is required, only the accessible parking locations that have been isolated for the investigated train (step 3).
2. *Selecting a transition train service*: The services are selected, starting with the conflicting train services listed in the reachability conflict list (if listed) and progress towards those complemented by the DRP operating concept. However, the order in which the potential transition train services is selected is of no relevance (see subsection 9.4.3).
Before the exploration can move from one service to the next, the PVSCS for the selected service must be developed such that it covers all accessible infrastructural elements that can be selected (step 3).

The only exception is in case the selected measure foresees a decoupling of the train. In this case, to provide the system with different alternatives, two train services must be selected in order to be assigned to the decoupling vehicle composition.

3. *Selecting accessible infrastructural elements*: whether at end stations (i.e. DRP turning stations or end station), or any other station where there a transition of services is foreseen, different accessible infrastructural elements can be selected.

The selection of the listed infrastructural elements depends on the selected elemental conflict solution alternative(s), which are further guided by the verification process from subsection 9.7, as detailed below.

- For parking: The PVSCS must be generated for every parking location isolated for the train, as detailed in subsection 9.4.1. The first PVSCS developed starts with the parking location closest to the train's actual location in the network (considering its driving direction).
- For early turns: implementing an early turn in the PVSCS of an investigated train requires narrowing down the best turning station in the network, where the transition (i.e. turn) to the selected train service can be implemented, as discussed in subsection 8.4.5. The PVSCS are developed starting with the train's early turn at the turning station the closest to the disrupted section (among all its isolated turning stations – see subsection 9.4.1). The selection of further accessible infrastructural elements follows the guidelines indicated throughout the two-level operational feasibility verification detailed in subsection 9.7.
- For a transfer between sides: the PVSCS are generated for all accessible deviation paths for an investigated train, starting with the closest deviation point to an investigated train.
- For coupling: the PVSCS that foresee the coupling of an investigated train are developed by first selecting the coupling counterpart train(s) already identified in subsection 8.4.3 and then establishing the best coupling location within the disrupted network.
 - During a complete blockage, the solution alternative is likely combined with an early turn or a transfer, in which case the guidelines for both of these cases must also be observed. The development of the PVSCS starts with the closest station at which an investigated train can couple with its selected coupling counterpart. Further infrastructural elements are selected as established in the guidelines detailed in subsection 9.7.
 - During a partial blockage, the generation of the PVSCS starts with the closest station at which an investigated train can be coupled with its selected coupling counterpart before they reach the critical area (if possible). This reduces the number of trains circulating in the disrupted section. The selection process for further infrastructural elements follows the guidelines established in the feasibility verification detailed in subsection 9.7.
- For decoupling: as with coupling, the best location in the disrupted network must be established.
 - During a complete blockage, the solution alternative is likely combined with an early turn or a transfer, in which case the guidelines for both of these cases must be observed.

-
- During a partial blockage, for a non-divided line, the development of the PVSCS starts at the nearest station after the train has exited the critical area (if possible). The selection process of further infrastructural and elements follows the guidelines established in the feasibility verification detailed in subsection 9.7.

It must be noted that all isolated infrastructural elements for an investigated train that stand beyond the commuter railway network (not including deviation paths between sides for the transferring of trains) are always considered as plausible alternatives for the development of a train's PVSCS. These must be selected once the infrastructural elements within the network have been already handled, particularly following the implementation of an early turn, the coupling and the decoupling of trains.

Having selected the elemental conflict solution alternative(s), the train service(s) to which an investigated train is set to transition (i.e. to adjust the circulation plan) and the accessible infrastructural elements, the developmental constraints can now be established.

Establishment of PVSCS Development Constraints

For every group of elements selected from the lists, the constraints for the development of the PVSCS are established. The constraints must be acknowledged so as to ensure that the PVSCS is developed in such a way it abides with the requirements discussed in subsection 9.2.1. This subtitle details the establishment of the constraints that frame the development of a PVSCS.

The constraints are derived from the elements that have been selected from the lists of isolated basic components, the approaches that have been chosen to develop the PVSCS (see subsection 9.2), the solution approach from the chosen elemental conflict solutions (see subsection 6.3), and the requirements discussed in subsection 9.2.1.

Overall, eight constraints have been identified. The eight elements are detailed below as:

- *Elemental conflict solution alternative(s)*: The implementation of the selected elemental conflict solution alternative(s), whether combined or not, must follow the requirements and solution approach discussed in subsection 6.3.
- *Starting node*: The starting node in the PVSCS must be located. This node is the one the closest to the train's actual location (registered at the deployment time) following its direction of travel (see subsection 5.4).
- *Objective node*: The objective element is determined by combining the information regarding the chosen solution alternative and accessible infrastructural elements.
- *Baseline-PVSCS*: Considering that the starting and objective nodes can be established, the string of nodes connecting these elements and the spatiotemporal information must also be established, as discussed in subsection 9.5.1. In general, this information may be established by taking into consideration the conflict solution alternative (e.g. transference, early turn, etc.), the investigated train's evaluated category, and the use of infrastructural elements not covered in the train's original schedule. Furthermore, the need to rely on the attributes of the infrastructural elements in the enhanced macroscopic modelling technique would also become evident as indicated in subsection 9.5.1.
- *Circulation plan*: The circulation plan associated with the selected transition train service is set to replace the original circulation plan assigned to an investigated train until the end station of the transition train service (see subsection 3.6.2).

- *Baseline-PVSCS for the transition train service*: The baseline-PVSCS considering the above-described constraints must also be acknowledged for the transition train service selected from the list.
- *Estimated disruption length*: The disruption length (t_{EDL}) would mark the moment in time in which the train services in the circulation plan should be able to drive beyond the disrupted section in case of a complete blockage. Imposing such generalization allows simplifying the adjustment to the circulation plan, which must be conducted until the end-of-day operations for every line (see subsection 3.4.2).
- *Train number(s)*: Due to the disruption, the operations in the network may need to recognize the existence of two different sides (see subsection 5.3). Therefore, the need to implement special train numbers to refer to train services of the same line at opposite sides of the disrupted network must be established. The implementation of special train numbers is discussed in subsection 3.6.2 and 5.3.2. Nonetheless, portions of the PVSCS of any removed or incorporated train would also require a special train number to account for their shunting movements throughout the network.
- *Exceptional involvement of other trains*: As per the selected solution alternative (e.g. coupling), the information described above must be defined for all involved trains.
- *Special Consideration for Incorporating a Parked Train*: As discussed in subsection 6.3.2, parked trains also require considering an estimated time for their departure from their respective parking locations.

Having established the developmental constraints, the PVSCS can now be developed.

Development of the PVSCS

The development process incorporates the constraints discussed in the previous subtitle and develops the PVSCS $d_{T_{ts,i}}$. As discussed in subsection 3.5.2, a PVSCS not only constitutes a line-specific conflict resolution alternative that is developed at the vehicle-specific level, but it is also aligned towards addressing the two disruption-management problems addressed by the system, namely the adjustment of the schedule and the circulation plans. As detailed in the module's structured approach, the development of the PVSCS is conducted through the right-shift rescheduling approach modified for its utilization within the dynamic DRP deployment system (i.e. considering a baseline-PVSCS – see subsection 9.5.1). This subsection details the general aspects supporting the development of the PVSCS.

In short, as discussed in subsection 9.2.1, the development of the PVSCS entails establishing the string of nodes that constitute the PVSCS and the spatiotemporal information across each one of the nodes while taking into consideration the adjustment of the circulation plan. The spatiotemporal information and the adjusted transition between train services are derived from the constraints discussed in the previous subtitle and the baseline-PVSCS for the investigated train. However, considering the broad range of possible modifications that need to be established across both the spatiotemporal information in the original schedule and to adjust the circulation plan, there are certain aspects that require special attention during the development of the PVSCS.

Regarding the spatiotemporal adjustments, five aspects have been recognized to require special attention during the PVSCS development process in order to ensure the resulting PVSCS is compatible with the requirements. The five aspects have been derived from the solution approach of every predefined line-specific elemental conflict solution detailed throughout subsection 6.3 (see also subsection 6.4) and the need to incorporate modifications to the originally planned route

of a train due to the existence of the DRP operating concept or the chosen accessible infrastructural element(s) (see subsection 9.5.1).

- *Temporal requirements:* Following the solution approach of the implemented conflict solution (see subsection 6.3), the PVSCS must support all necessary temporal requirements at the relevant nodes across all involved train services (i.e. the investigated train and the selected transition train services). For example, it must adhere to the minimum transfer times for transition train services (e.g. coupling, turning –see subsection 3.6.2) or the minimum time for emptying a train (with and without a change in the driving direction – see subsection 3.6.2). Consequently, the baseline-PVSCS must not only modify the spatiotemporal information in the original schedule in correspondence to the category of the investigated train but also considering the above-explained temporal requirements.
- *Initial delay:* It should be noted whether an investigated train has an initial delay or not. This has been identified in previous modules (see subsection 5.4.2) and must be supported during the development of the PVSCS between an investigated train’s actual location in the network and the objective node.
- *Threading-in and threading-out times:* threading times outside or inside of the commuter railway system cannot be supported at this stage because the PVSCS is conducted considering an empty network.
- *Additional stopping times:* Depending on the nodes traversed through any potential deviation path and the time of day, the train can be scheduled to stop at an intermediate station. Specific stations must be selected so as to include the necessary stopping times in the PVSCS. These stations are selected during the offline identification of second-order elements (see subsection 7.3).
- *Modifying the projected arrival and departure times:* the arrival and departure times to and from each node must be considered with respect to changes established in the baseline-PVSCS. This modification must be consistent with the journey time attributed to the infrastructural model. Having included all the temporal modifications between starting and objective node for an investigated train and securing the adjustment of its circulation plan to the selected transition train service as well as all following services, the times in the PVSCS would be recognized as scheduled times. Henceforth, the arrival and departure times detailed in the PVSCS are treated as scheduled values in order to support the CDCR process once the PVSCS are selected and combined (see subsection 3.5.2).

Regarding the adjustment of the circulation plan of the vehicle or vehicle compositions of the train, three aspects require special attention during the PVSCS development process in order to ensure the PVSCS is compatible with the requirements. The three aspects have been derived in the same way as for the spatiotemporal adjustments; however, in this case, the requirements detailed in subsection 9.2.1 play a preeminent role.

- *Adjustment of the Circulation Plan:* At the end station or in concordance with the selected elemental conflict solution alternative, the circulation between an investigated train and the selected transition train service must be guaranteed, as discussed in the border conditions.

Furthermore, since the transition between the current train service and the transition train service selected from the list only supports this specific circulation, the rest of the circulation plan within the disruption length (t_{EDL}) still needs to be established. As it is expected that stability can be reached by addressing the line-specific conflicts throughout

all the trains of one line, the simplified approach discussed in subsection 9.4.3 is utilized to complement the selection of transition train services and establish the rest of the circulation plan for an investigated train.

By implementing this approach, the following train services added to the circulation plan of the vehicle composition are selected based on the scheduled arrival and departure times at the stations where the DRP operating concept of an investigated train's line foresees a circulation to take place (i.e. end, coupling or decoupling stations). Therefore, depending on the type of circulation taking place at the station, the following three lineaments can be advanced:

- *At DRP turning stations and end stations:* the transition between services is always conducted to the most immediate train service of the respective line, which is scheduled to depart from the station, and that guarantees a positive turn.
- *At coupling and decoupling stations:* the transition between services is upheld or removed as requested by the DRP operating concept.
- *General Limitation:* For all cases described above, the estimated disruption length t_{EDL} vis-à-vis the deployment time $t_{0,TD}$, must be considered. Therefore, once the disruption is expected to be finished (i.e. t_{EDL}), the projection of the train services must resume normal operations as discussed by the PVSCS development constraints. Thus, starting with the train service in an investigated train's circulation plan that has a scheduled departure from the LtfTS beyond the t_{EDL} , the rest of the services included in the circulation plan must match the original schedule.
- *Involvement of other trains due to coupling as a line-specific conflict solution:* Depending on the position of the trains being handled and the station where the coupling is set to take place, an additional waiting time may be introduced for the first train after its arrival at the coupling station and until the arrival of the second train. From the coupling station, the remaining portion of the PVSCS (i.e. until the end station) must be developed according to the selected train service and circulation plan product of the transition (i.e. coupling).
- *Involvement of other trains due to decoupling as a line-specific conflict solution:* Depending on the position of the train being handled and the station in which the decoupling is set to take place, a completely new vehicle composition must be recognized. The new vehicle composition has been assigned an alternative investigation order so that after the decoupling, a PVSCS is generated (see subsection 9.3), and a circulation plan adequately assigned. However, any deficiencies identified during the technical or operational verification processes would affect the viability of both developed PVSCS. Thus, the resulting PVSCS must be handled together as a permanent pair.

9.6. Verification of the Technical Feasibility of PVSCS

Once the PVSCS $d_{T_{ls,i}}$ has been developed, its technical feasibility must be verified, as discussed in subsection 3.5.2 and displayed in figure 9.1. The technical feasibility of all the PVSCS must be verified to determine whether the train is compatible with the technical characteristics of the infrastructural elements along its route (see subsection 3.6.2). This subsection describes the technical verification of each developed PVSCS briefly.

The technical feasibility of each PVSCS is evaluated by distinguishing between absolute and soft exclusion criteria, as in the approach introduced in Brauner (2019) (see subsection 2.3.3). By allowing this distinction, modifications can be made to the PVSCS before they are rejected. The technical verification is especially necessary if the elements have not been already evaluated, as discussed in subsection 7.3.1.

The technical verification is critical for ensuring the practical relevance of the line-specific resolution alternatives (see subsection 3.4.2), especially for portions of the PVSCS outside of the commuter railway network. Although the baseline-PVSCS allows establishing the spatiotemporal characteristics throughout these areas based on the attributes of the modelled infrastructural elements, their technical compatibility must still be verified.

Technical validation is done sequentially for all infrastructural elements in the PVSCS, beginning with the absolute exclusion criteria. Once the PVSCS have been validated for their absolute exclusion criteria, the soft exclusion criteria can be verified. This process involves the systematic identification and modification of smaller technical incongruences for the PVSCS in line with the characteristics of infrastructural elements (if needed). Ultimately, the technical feasibility is confirmed, ensuring that all necessary spatiotemporal modifications are considered before for the operational verification is conducted.

9.6.1. Absolute Exclusion Criteria

Absolute exclusion criteria highlight characteristics of the infrastructural elements whose potential misalignments with those of the model train of an investigated train would be irreversible and render the PVSCS completely impractical. Therefore, any incompatibility between the train and the infrastructural elements following absolute exclusion criteria is conducted first so as to immediately establish the technical unfeasibility of the PVSCS.

Absolute exclusion criteria can occur, among other characteristics, due to: difference in the gauges, incompatible electrification style (e.g. lack of an overhead wire), or crew capability (e.g. if the train driver is able to drive-through the contemplated route). Consequently, if the PVSCS contains elements within its string of nodes and links that fail to fulfill this criterion, the PVSCS must be discarded. However, if no misalignments are identified, the PVSCS can have its soft exclusion criteria verified.

9.6.2. Soft Exclusion Criteria

Through the soft exclusion criteria, the need to develop modifications on the PVSCS because of the presence of smaller inconsistencies between the respective model train and the infrastructure can be ascertained. Some examples of possible soft exclusion criteria include train protection technology and platform lengths. If these misalignments are identified, the spatial and temporal information of the PVSCS must be modified.

For example, if the platform length at a station is not compatible with the model train, a different platform track at the station may be utilized, or eventually, the stop of the train in such station may be removed entirely from the PVSCS.

9.6.3. Summary

Once the technical relevance of the PVSCS has been validated and the necessary spatiotemporal modifications introduced, the operational feasibility of the PVSCS can now be considered. This implies that the next step in the verification process of the PVSCS can be conducted.

9.7. Verification of the Operational Feasibility of PVSCS

As it has been argued in subsection 3.4.2, the PVSCS development must secure that the PVSCS sets are able to cover the broadest range of possible handling alternatives for every train. These alternatives contain the best possible combination of line-specific conflict solution alternative, transition train service, and the accessible infrastructural element, which permit the affected line and, in due course, the whole network to transition to stable operations. While the isolation of the infrastructural elements and the selection of potential handling alternatives discussed in subsection 9.4 has allowed different PVSCS to be developed, the section of the isolated elements does not imply that all PVSCS possibilities can be considered to have operational feasibility (see subsection 3.5.2). This subsection details the verification of the operational feasibility for all the developed PVSCS.

Overall, the verification of the operational feasibility carries particular relevance within the overall PVSCS development as it allows to guarantee that the different PVSCS, which are ultimately included in the PVSCS set for a train, can support the objectives of the dynamic DRP deployment system (see subsection 3.5.2). To secure the developed PVSCS have operation feasibility, their ability to reach a stable operation is examined in detail.

The operational verification process concentrates on assessing the implemented elemental conflict solution alternative, the constraints identified in subsection 9.5.2 and any modification incorporated during the technical validation. Since the ability to reach stable operations is primarily influenced by the transition between train services (Chu 2014 and subsection 2.3.3), the verification process is focused at the locations in the network in which this is likely to take place. These locations are usually the end station of the train services either at stations located the furthest from the disrupted section of those the closest to the disrupted section (in case the trains have a DRP turning station). As a result, the verification of the PVSCS is conducted on two different levels.

The first level is a pre-emptive verification conducted on PVSCS that contains an early turn and focused on the locations closest to the disrupted section. Particular importance is given to the elemental conflict solution alternatives at these locations not because they are the most utilized within disruption-management (see subsection 2.3) but because there is a high likelihood they would engender a delayed service after the turn. The early turns are assessed with the turn residual approach already discussed in subsection 8.4.5 and 3.7.2.

The second level highlights the actual capability of the PVSCS to reduce any engendered delay. While the first level is only verified for PVSCS that foresee an early turn, the second level is conducted for almost all developed PVSCS. The sole exception is found in PVSCS that foresee the removal of the train towards a parking location without a prior change of a train's driving direction.

The following subsection discusses the verification process within each level in detail and provides an overview of guidance and communication throughout the selection process of the elements in the three lists, as discussed in subsection 9.5.2.

9.7.1. Turn Residual

As discussed in subsection 3.7.2, the transition between train services at a specific location of the network after an early turn may be assessed by means of the turn residual. The turn residual permits to verify the operating situation of a PVSCS $d_{T_{l_s,i}}$ in cases where an investigated train is turned at one of its isolated turning stations. This verification level is only applied to PVSCS that include an early turn as one of their conflict solution alternatives, whereas all other PVSCS must have their operational feasibility immediately verified in the subsequent level.

The verification of the operational feasibility at this level focuses on establishing whether the transition of the train to a potential train service at a specific turning station would engender a delayed or an on-time train service. In this way, the turn residual supports the first spatiotemporal verification of the PVSCS. Furthermore, by communicating the results to the guided selection process (see subsection 9.5.2) it is possible to steer the development of PVSCS.

The systematic assessment of the early turn as a solution alternative has already been reviewed in subsection 8.4.5 during the classification of the reachability conflicts. Within this assessment, the turn residual was verified across all accessible turning stations for all trains clustered in the Green or Yellow categories of a given line. This information can be reviewed in the respective turn residual matrixes $TR_{Trc_{l_s}}$ for the conflicting services and does not need to be calculated again. The values can be immediately derived for an investigated train $T_{l_s,i}$ which is set to transition towards one of the conflicting services Trc_{l_s} at turning station TS_a (see subsection 8.4.5).

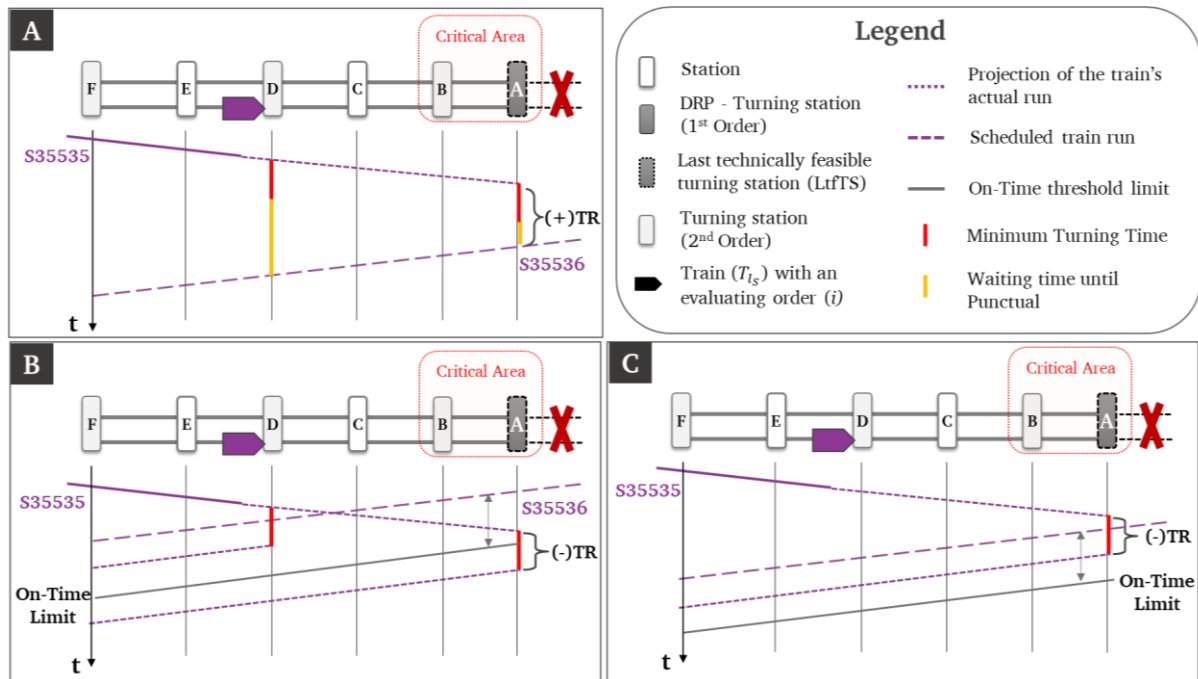

Figure 9.4 Example of turn residuals after early turning an investigated train: A. Positive turn residuals; B. Negative turns with delay; C. Negative turn on-time (by author)

However, for the early turning of trains towards transition services outside of the reachability conflict list, the turn residual still needs to be computed. Therefore, equation 8.20 introduced in subsection 8.4.5, is generalized as detailed in equation 9.1. The equation supports a general approach for the calculation of the turn residual, where an investigated train $T_{l_s,i}$ is early turned at a turning station TS_a and transitioned towards a train service Q . It must be noted that in cases

where the early turn is combined with a decoupling, the turn residual must be ascertained for each transition train service separately.

$$TR_{T_{l_s,i}-Q}^{TS_a} = t_{Sched.Dep}^{TS_a} - t_{Proj.Arr}^{TS_a} - \min t_{Turn} \quad (9.1)$$

Having ascertained the turn residual value, the operational verification and the establishment of the guidelines to be communicated to the selection process in subsection 9.5.2, must be established. Since for early turns, the first PVSCS being developed for an evaluated train is conducted at its isolated turning station located the closest to the disrupted section (see subsection 9.5.2), a set of guidelines based on the turn residual calculated for the PVSCS at this location may be established.

For the resulting turn residuals calculated as in equation 9.1 or derived from the respective matrix $TR_{Trc_{l_s}}$, two general possibilities exist:

- If the resulting turn residual is positive, a positive turn is generated, and the PVSCS can be introduced in the PVSCS set $D_{T_{l_s,i}} \{ d_{T_{l_s,i}}, \dots, z_{T_{l_s,i}} \}$ (see subsection 9.8). An example of this is depicted in figure 9.4-A.

In case the positive turn takes place within the critical area, a burden is being placed on the disruption-management process by idly consuming capacity at critical stations. Hence, as a guideline for the selection process (subsection 9.5.2), no more PVSCS that incorporate the same transition train service must be generated for the early turning at further stations in the critical area (despite they are accessible for the investigated train).

However, one last PVSCS, which foresees the turning of the train to the same transition train service at least one turning station before the critical area (if accessible for an investigated train), must be generated and introduced in the PVSCS set $D_{T_{l_s,i}}$. This last guideline would ensure that an alternative that avoids the train circulating within the critical area is generated. Ultimately, the next transition train service can be selected.

- If the turn residual results in a negative value, its magnitude must be carefully observed. The resulting turn residual must be verified in correspondence to its potential to generate a train that might still be considered on-time (as in equation 8.22).

- If the magnitude falls within the threshold that allows the train to be still considered on-time after its turn (see subsection 3.6.2), the PVSCS can be introduced in the PVSCS set $D_{T_{l_s,i}}$ (see subsection 9.8). An example of this situation is depicted in figure 9.4-C.

However, the early turn of the investigated train and its transition to the same train service at other accessible turning stations may still engender a train service within the on-time threshold; thus, further PVSCS must be developed. As a guideline for the selection process (subsection 9.5.2), PVSCS that feature the early turn of the investigated train to the same transition service must be generated systematically at previous accessible turning stations until the first positive turn is established, or until all accessible turning stations for the train have been verified. All these alternatives, including the one yielding the potential positive turn, are introduced in the PVSCS set $D_{T_{l_s,i}}$.

- If the magnitude falls outside of the threshold that allows the train to be still considered on-time after its turn (see subsection 3.6.2) and the early turn is not

combined with the parking of an investigated train, the next level in operational feasibility verification must be conducted. An example of this situation is depicted in figure 9.4-B.

Furthermore, PVSCS that feature the early turn of the evaluated train towards the same transition train service throughout all remaining accessible turning stations become relevant. Exploring the early turn of the investigated train to the same transition train service throughout all its remaining accessible turning stations may reveal one or more turns that generate an on-time train service (e.g. an early turn in station “D” for the train in figure 9.4-B). Therefore, as a guideline for the selection process (subsection 9.5.2), PVSCS that feature the early turn of an investigated train to the same transition train service must be generated systematically at previous accessible turning stations until the first positive turn is established. For all PVSCS with a turn residual magnitude outside the on-time threshold, the next level in the operational feasibility verification must be conducted. Once the turning station that generates an on-time train is established (if possible), the guidelines in the previous point area applicable.

- If the magnitude falls outside of the threshold that allows the train to be considered on-time after its turn and the PVSCS is combined with the parking of an investigated train, the PVSCS can be introduced in the PVSCS set $D_{T_{IS},i}$ (see subsection 9.8). Furthermore, as a guideline for the selection process, the guidelines detailed in the previous point can be applied (see subsection 9.5.2). However, in this case, only the PVSCS, which generate a train service within the on-time threshold including the first positive turn, is introduced in the PVSCS set and the rest can be discarded. This is the case since no additional benefit is derived from maintaining PVSCS that engender a heavily delayed train outside of the critical area that will be removed from circulation.

9.7.2. Reduce Delay

At this level, the verification concentrates on the situation of an investigated train once it reaches its end station. The verification establishes if the PVSCS is capable of reaching operational stability, or eventually, if further measures are required for this to take place.

The verification determines whether the delay engendered in the PVSCS can be reduced, as displayed by the three examples presented in figure 9.5. The delay within a PVSCS is engendered due to the triplet of elements selected from the lists of isolated elements in subsection 9.5.2 (i.e. dispatching measures, transition train services and accessible infrastructural elements). The verification is possible since the original schedule foresees turning times at end stations (i.e. transition times) that are larger than the minimum turning times required by the guidelines (see subsection 3.6.2). This characteristic makes the schedule more robust and protects it against disturbances in regular operations. Since the PVSCS are generated based on the original schedule (i.e. baseline-PVSCS), the ability to reduce the delay can be immediately verified.

Assessing the ability of a PVSCS to reduce its delay follows a similar process as the one utilized for ascertaining the turn residual. The ability of the PVSCS $d_{T_{IS},i}$ to reduce its delay is based on projecting the conditions after the train has transitioned to the train service detailed within its adjusted circulation plan at its end station.

A train is able to reduce its delay if at the end station, the transition train service (in its adjusted circulation plan – see subsection 9.5.2) is able to depart from the station at least within the on-time threshold t_{Ot} (i.e. $t_{Ot} = -6 \text{ min}$ – see subsection 3.6.2). Therefore, the ability to reduce the delay at the end station S_a (the furthest from the disrupted section) for a transition of train service Q to a train service R is computed as in equation 9.2.

$$t_{Sched.Dep_R}^{TS_a} - t_{Proj.Arr_Q}^{TS_a} - \min t_{Turn} \geq t_{Ot} \quad (9.2)$$

Having ascertained the ability of the PVSCS to reduce its delay, the verification permits to deduce better guidelines to be conveyed to the selection process in subsection 9.5.2. It must be noted that for PVSCS that entail decoupling measures, the ability to reduce the delay must be ascertained for each transition service separately, and the guidelines explained below apply for each of the ascertained results.

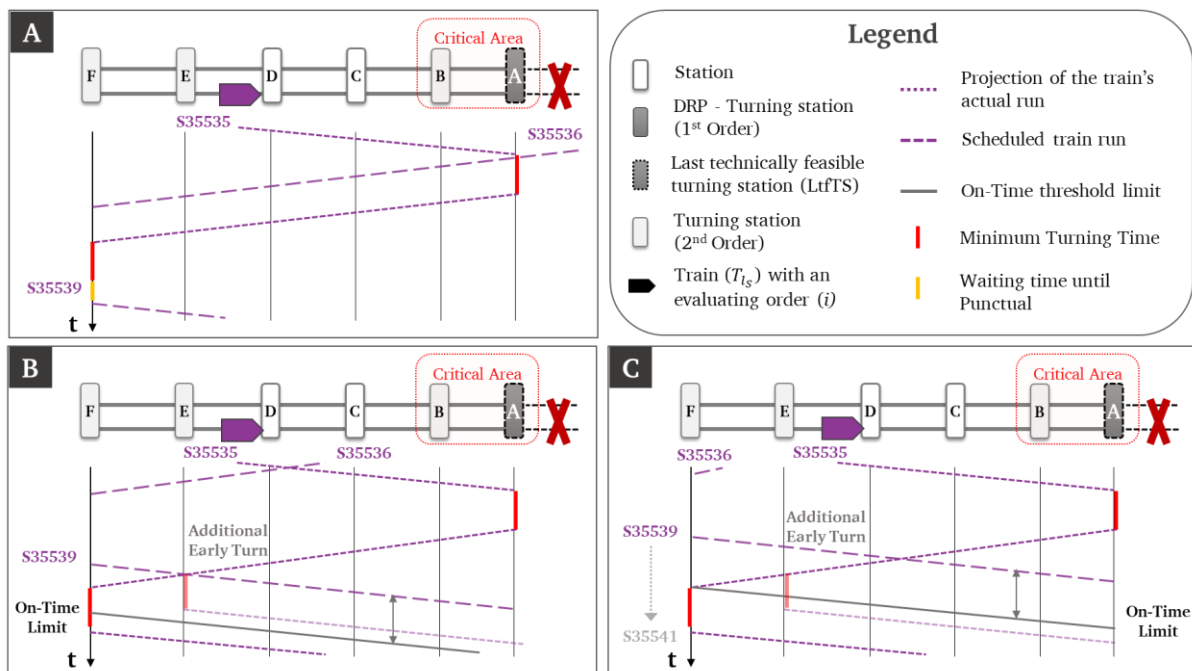

Figure 9.5 Examples of the ability to reduce the delay: A. Complete reduction of the delay at the end station; B. Complete reduction of the delay after an early turn; C. Reduction by an exchange of the train service at the end station (by author)

The guidelines established within this level of the operational verification rely on the guidelines explained in the previous level (if applicable) as a foundation, distinguishing two overall possibilities:

- If the relation in equation 9.2 is satisfied, the generated delay can be reduced. Therefore, the PVSCS can be immediately included in an investigated train's PVSCS set $D_{T_{i_s,i}} \{d_{T_{i_s,i}'}, \dots, z_{T_{i_s,i}}\}$ without any further modifications. These circumstances are depicted in figure 9.5-A. Furthermore, depending on the solution alternatives selected to generate the PVSCS, the guidelines for the selection process (see subsection 9.5.2) stand as follows:
 - For early turns: the guidelines already detailed in the previous verification level (i.e. turn residual) are respected and unaltered.

- *For coupling*: the coupling of an investigated train with the next possible coupling counterpart can be generated. Ultimately, if there are no more coupling counterparts, the next transition train service in the list is selected.
- *For decoupling*: no further PVSCS for the current transition services are required, and the next transition service in the list is selected.
- *For transfers*: the PVSCS for a transfer at the next deviation path can be generated. Ultimately, if there are no more deviation paths, the next transition train service in the list is selected.
- If the relation in equation 9.2 is not satisfied, the delay cannot be reduced. In a final effort to salvage the PVSCS, the ability to reduce the train's delay is verified through the implementation of an additional measure. A standard approach to deal with circulation conflicts is the implementation of an early turn, which in this case would allow for a further reduction of the delay (see subsection 6.3.6). Therefore, the verification is conducted as if the PVSCS foresees an early turn one station prior to the end station (the furthest away from the disrupted section).
 - If the relation in equation 9.2 computed for an early turn one station prior to the end station is satisfied, the PVSCS can be immediately introduced in the train's set $D_{T_{l_s,i}}$ without any further modifications. The PVSCS is not adjusted to include the additional early turn as in figure 9.5-B since this is left to the vehicle-specific CDCR process (see section 11) so as to reflect the actual cost of utilizing the measure within the PVSCS. Furthermore, the guidelines conveyed to the selection process discussed in the previous case are also valid under these circumstances (see subsection 9.5.2).
 - If the relation in equation 9.2 computed for an early turn one station prior to the end station is not satisfied, depending on the conflict solution alternatives in the PVSCS, the guidelines for the selection process (see subsection 9.5.2) stand as follows:
 - *For early turns*: if the early turn has been conducted in the turning station the closest to the disrupted section, the PVSCS is introduced in the PVSCS set without further modification $D_{T_{l_s,i}}$. Simultaneously a copy of the PVSCS is generated, yet in this case, the circulation plan at the end station is modified so that the transition is conducted to the following train service departing from the station. The modified copy is also introduced in the PVSCS set $D_{T_{l_s,i}}$ for the investigated train. Both of the above-discussed circumstances can be appreciated in figure 9.5-C. Preserving the PVSCS with an early turn at the turning station, the closest to the disrupted section ensures that the investigated train's set of PVSCS has at least one PVSCS for every transition train service in the list. However, if the early turn in the PVSCS is conducted at any other isolated turning station (e.g. stations B in figure 9.5-C), the PVSCS can be immediately discarded. The guidelines already detailed in the previous verification level (i.e. turn residual) are respected and unaltered.
 - *For couplings*: the PVSCS must be temporarily saved until the PVSCS for all coupling counterparts is generated. If at least one PVSCS with operational feasibility exists, these are introduced in the PVSCS set for the train

$D_{T_{l_s,i}}$ and all unfeasible PVSCS are discarded. If not, the PVSCS with the least amount of delay at the end station is introduced in the set $D_{T_{l_s,i}}$ without further modification. Simultaneously a copy of the PVSCS is generated, yet in this case, the circulation plan at the end station is modified so that the transition is conducted for the following train service departing from the station. The modified copy is also introduced in the PVSCS set $D_{T_{l_s,i}}$ for an investigated train. Ultimately, the next transition train service on the list can be selected.

- *For decoupling:* the PVSCS is temporarily saved until a PVSCS for all the transition services in the list is generated. If there are PVSCS with operational feasibility, these are introduced in the PVSCS set for the train $D_{T_{l_s,i}}$ and all unfeasible PVSCS are discarded. If not, the PVSCS with the least amount of delay at the end station is introduced in the set $D_{T_{l_s,i}}$ without further modification. Simultaneously a copy of the PVSCS is generated, yet in this case, the circulation plan at the end station is modified so that the transition is conducted to the following train service departing from the station. The modified copy is also introduced in the PVSCS set $D_{T_{l_s,i}}$ for an investigated train.
- *For transfers:* the PVSCS is temporarily saved until a PVSCS throughout all possible transfer paths is generated. If there are PVSCS with operational feasibility, these are introduced in the PVSCS set for the train $D_{T_{l_s,i}}$ and all unfeasible PVSCS are discarded. If not, the PVSCS with the least amount of delay at the end station is introduced in the set $D_{T_{l_s,i}}$ without further modification. Simultaneously a copy of the PVSCS is generated, yet in this case, the circulation plan at the end station is modified so that the transition is conducted to the following train service departing from the station. The modified copy is also introduced in the PVSCS set $D_{T_{l_s,i}}$ for an investigated train.

9.8. PVSCS Set Arrangement

Once the technical and operational feasibility of a PVSCS has been verified and its relevance substantiated, it is introduced in the set of PVSCS for an investigated train, as indicated above. The PVSCS arrangement is the last step within the PVSCS generation process with the purpose grouping the technically and operationally feasible PVSCS for an investigated train $T_{l_s,i}$, and arranging them such that their combination in subsequent modules is simplified.

The generated PVSCS can be arranged within the PVSCS sets by distinguishing different characteristics. Possible characteristics that are relevant for this arrangement, as part of the dynamic DRP deployment system, are: the elements within each of the three lists discussed in subsection 9.5.2 or the operational feasibility of the PVSCS. However, the PVSCS are already developed by a guided combination of the elements in the three lists, as discussed in subsection 9.5.2, which is supported by the verification of the operational feasibility of the PVSCS (see subsection 9.7). Thus, if every developed PVSCS maintains the order in which it was generated as

they are introduced in the PVSCS set, this would inherently derive a purposeful arrangement of the resulting PVSCS sets.

Consequently, the arrangement of the different PVSCS within the PVSCS set is aligned with the selection and combination of the elements in the three lists. At first, the elements are generated following the list of isolated conflict solution alternatives, which are organized according to the line-specific conflict lists. For all elements with the same solution alternative(s), the different PVSCS in the set are further arranged with respect to the transition train service utilized to establish their circulation plan. Finally, for all elements with the same transition service, the PVSCS are further arranged with respect to the accessible infrastructural elements, as indicated in the selection process (see subsection 9.5) and the guidelines established in subsection 9.7.

In due course, the set $D_{T_{l_s,i}} \{d_{T_{l_s,i}}, \dots, z_{T_{l_s,i}}\}$ of arranged PVSCS for an investigated train establishes a subset within the set $D_{l_s} \{D_{T_{l_s,i}}, \dots, D_{T_{l_s,n}}\}$ of PVSCS for all trains servicing line l_s . Ultimately, the set D_{l_s} constitutes a subset within the set of technically and operationally feasible PVSCS for all trains with an investigation order in the disrupted network $D \{D_{l_s}, \dots\}$.

9.9. Closing Remarks

The purpose of this section is to present a close account of the PVSCS development process as part of the repairing heuristic detailed in subsection 3.5.2. Throughout this subsection, the specific processes that constitute the approach for the development of technically and operationally feasible PVSCS for every train have been discussed in detail. The PVSCS within the sets developed for each of the investigated trains can now be selected and combined so as to structure the targeted conflict-free schedule for the disruption.

The process of isolating the potential handling alternatives stands among the key steps within this module (see subsection 9.4). It is in this process that the dynamic DRP deployment system merges the line-specific guidelines of the DRP operating concept of the affected liens with each of the trains in the network. Furthermore, this process is also critical for the adjustment of the overall system to the available computational effort. The lineaments advanced within the subsection can be modified to be more or less restrictive and satisfy the available computation time.

The development and verification processes that have been put together as part of this module's structured approach supported the establishment of PVSCS for all trains in the network while taking into consideration the transitioning of the disrupted network to stable operations. This was done for the most part during the selection of the elements from the lists of isolated handling alternatives utilizing information from already developed and verified PVSCS (see subsection 9.5 and 9.7).

Furthermore, the line-specific DRP operating concept also played an essential role in the establishment of the processes throughout this module. Either by introducing the already classified line-specific conflict list, or establishing the potential transition services for an investigated train, the implemented DRP operational concept can be traced as the main input for this module. Consequently, the PVSCS development process is highly reliant on the existence of the DRP's and any modifications so as to support the generation of the train PVSCS without them would require a completely different approach.

Each verified PVSCS within a train's PVSCS set stands as a possible resolution path to address the line-specific conflicts. While every element that is included in the PVSCS set increases its complexity, the necessary processes have been introduced to secure only the most operational and technically relevant PVSCS are included in each set. The main advantage of the PVSCS development framework proposed in this module lies in the merger of existing and innovative approaches designed to secure only the handling alternatives that are conducive towards stable operations are included in the resulting PVSCS sets.

Although the approaches within each of the PVSCS development processes are aligned with the dynamic DRP deployment system, they can easily be retrofitted to match any implementing field. Therefore, by modifying specific processes to restrict or relax the verification of the generated PVSCS, changes in the complexity threshold can be tackled. This is the case for the baseline-PVSCS, which can be replaced with a more composite rerouting heuristics if ample computational effort is available. On the other hand, if the complexity of the resulting sets is to be further limited (e.g. in order to reduce the computation time of the system), the operational verification of the PVSCS can be made much more stringent by removing or adjusting the on-time threshold limit.

Ultimately, by merging the different processes detailed in this section, the technical and operational quality of the resulting PVSCS sets has been secured. Furthermore, they have been adeptly arranged within PVSCS sets for each of the trains circulating on the network. The arrangement of each of the sets abides with the guided selection of the three elements that constitute a PVSCS (i.e. line-specific elemental conflict solution alternative, transition service, accessible infrastructural elements). As a consequence, the resulting PVSCS within each of the PVSCS sets are ready to be selected and combined in their path towards becoming potential conflict-free schedules. The selection and combination of the different PVSCS in the PVSCS sets of every train are detailed in the following section.

10. Assembly of PVSCS Combinations

10.1. Introduction

The module in charge of the line-specific conflict identification and establishment of potential conflict solutions discussed in section 8 provided an overview of the operating situation for all the lines affected by the disruption. The line-specific conflict list established in section 8 supported the development of a wide range of PVSCS for every train in the network, which have been arranged within PVSCS sets as detailed in section 9. Every train's PVSCS set contains a broad range of alternatives to address the disruption. This module has as its main objective the assembly of PVSCS combinations, as established in subsection 3.5.2 and detailed in subsection 3.5.3. The assembly of PVSCS combinations allows the system to combine one specific PVSCS from the PVSCS set of every train and establish potential handling measures for all trains as a framework for the adjustment of schedule and circulation plan.

Overall, since every PVSCS combination should contain one specific PVSCS from the set of PVSCS of every train circulating in the network, it is possible to foresee the ample number of potential PVSCS combinations that can be generated in this module (see subsection 9.8). The ample number of combinations that can be generated provides the system with the ability to explore different handling alternatives for the different trains. Furthermore, since the different PVSCS for every train have been generated by considering an empty network, the moment they are assembled into a PVSCS combination, conflicts would most certainly be generated. Consequently, this module has two primordial tasks. On the one hand, the module must support the assembly of the PVSCS combinations, while taking into consideration the ample number of combinatorial possibilities. On the other hand, the module must ensure a communication with succeeding processes, namely, the vehicle-specific CDCR process and the assessment modules (see sections 11 and 12, respectively). As discussed in subsection 3.5.2 and detailed in subsection 3.5.3, every assembled PVSCS needs to be fixed (i.e. solve every conflict, making the PVSCS combination conflict-free) and assessed in order to achieve the targeted conflict-free schedule.

The complexity of the problem tackled in this section is not limited to the number of elements contained in the PVSCS sets of every train. Since the module must communicate with the subsequent vehicle-specific CDCR process, the conflicts that are being generated by the assembled PVSCS combination, particularly, within the critical area of the network, must also be taken into consideration. The handling of the queuing trains in the vicinity of the disrupted section is of particular importance for the system (see subsection 3.4.2). As discussed in subsection 2.3.3 and 3.5.2, queuing trains directly affect the ability of the system to reach stability. Furthermore, the focused handling of queuing trains around the LtfTS has been identified in existing disruption-management models as being critical for dealing with the limited capacity of the disrupted network and reducing delay (see subsection 2.3.2). Therefore, the assembly of PVSCS combinations to be established in this section is intended to generate specific PVSCS combinations as part of an ample combinatorial problem, while taking into consideration the composite constraints of handling queuing trains near the disrupted section.

As discussed in subsection 3.5.1, the utilization of metaheuristics is the most adept tool for dealing with the complexity of the problem. A key advantage of metaheuristics is their ability to explore the search space in a more proficient way than standard heuristics. Not only would they allow to deal with the problem's constraints but also incorporate the examination of the fitness of the proposed solution. Therefore, advancing the assembly of the PVSCS combinations utilizing these

methods may support the module's capability to address the complexity of the problem and adjust to the disrupted circumstances.

This section provides the structure for a metaheuristic approach to address the problem of the assembly of PVSCS combinations. The metaheuristic-guided assembly of PVSCS combinations selects and combines the elements in the PVSCS sets of every train in the network, such that they can be fixed until they are conflict-free schedules. Furthermore, considering the second task to be fulfilled by the module, an effective and efficient metaheuristic exploration would work in close connection with the processes that determine the fitness of the assembled combinations (i.e. CDCR and assessment modules – see sections 11 and 12 respectively).

In the following subsections, a structured approach and its respective processes to assemble the PVSCS combinations utilizing the PVSCS sets developed in section 9 are derived and discussed in detail. Initially, in subsection 10.2, an explicit discussion on the module's requirements and limitations supports a much more informed structuring of the module's structured approach. Thereafter, existing metaheuristic approaches are explored, and a structured approach to conduct the combination of the PVSCS is established in subsection 10.3. Later, in subsections 10.4 through 10.6, each of the processes that constitute the structured approach for the assembly of the PVSCS combinations are derived and discussed in detail.

10.2. Requirements and Limitations for the Combination of PVSCS

The assembly of the PVSCS combinations constitutes the beginning of the second step in the two-step repairing heuristic, as discussed in subsection 3.5.2. The PVSCS combinations being assembled through this module are later fixed by the vehicle-specific CDCR process, seeking to deliver the strived conflict-free schedules. This subsection presents a detailed exploration of the requirements and limitations for the assembly of the PVSCS combinations as part of the dynamic DRP deployment system.

Every single train in the network has a set of technically and operationally feasible PVSCS. The assembly of PVSCS combinations entails selecting one element from every train's PVSCS set and combining it with the PVSCS selected from the sets of other trains to produce a candidate schedule, which is made conflict-free in later modules (i.e. fixed). Consequently, the purpose of the assembly of PVSCS combinations is the construction of a series of PVSCS combinations such that the different handling alternatives, which have been established for every train in the network, are combined and explored.

Overall, the assembly of the PVSCS must take into consideration the specific objective of the dynamic DRP deployment system, namely, ensuring that the network is able to transition to stable operations and establishing a conflict-free schedule with sufficient quality to secure its practical implementation. Therefore, while the process for the assembly of PVSCS combinations must support the exploration of as many PVSCS combinations as possible, it must do so by ensuring that the transition to stable operations is supported and the quality of the solutions are sustained (i.e. solving the identified line-specific conflicts).

Furthermore, just as in previous modules, the assembly of PVSCS combinations must be aligned with the general requirements and limitations of the overall system (see subsections 3.3.2 and 3.4.2). Therefore, the PVSCS combination as a process must take care that it allows the system to maintain its general validity while being adjusted to the computational effort respective to its implementing field. These aspects are particularly important for this module since the

metaheuristic PVSCS combination process is the system's main engine in charge of the exploration of the search space so that the chosen DRP may be deployed to the disrupted operations according to the specific objectives (see subsection 3.2.2).

Since subsequent modules in the system (i.e. CDCR process and the assessment) are executed based on the PVSCS combination candidates assembled in this module, the assembly process must also consider both the line-specific operational constraints (e.g. DRP operating concepts) and as many of the infrastructural constraints at the vehicle-specific operational level (i.e. minimum transition times) as possible. In this regard, the assembly process of every PVSCS combination must pay particular attention to the already identified line-specific conflicts and the subsequent spatiotemporal adjustments that are foreseen to take place within the vehicle-specific CDCR process.

Focusing on the line-specific operational constraints entails advancing a robust selection process of each of the PVSCS in the PVSCS set of the different trains so that the line-specific conflicts identified in section 8 are resolved. During the development of the PVSCS sets, the established line-specific conflict solutions have been repeated on different trains of the same line so as to support the exploration of as many handling alternatives as possible. Therefore, since only one PVSCS from the set of PVSCS of every train is introduced in the PVSCS combination, their assembly must ensure that the selected solutions can address the line-specific conflicts of each of the lines.

At the vehicle-specific operational level, the general process of a general CDCR has been discussed in detail throughout subsection 2.2.3 and in the context of the dynamic DRP deployment system in subsections 3.5.2 and 3.5.3. Overall, the CDCR process identifies vehicle-specific conflicts within every assembled PVSCS combination and proceeds with the synchronous resolution of each conflict, incorporating a look-ahead principle. This last consideration indicates that the conflicts are resolved while bearing in mind the influence of possible solution alternatives for trains that are not directly involved in the conflict. Thus, the PVSCS combinations must be assembled so that the CDCR process may handle all the trains in the network (per side if applicable) and support the identification of the best solution alternative to resolve the identified conflicts. As a result, the PVSCS combinations must be complete in the sense that they must contain a PVSCS for every single train assigned an investigation order, as detailed in subsection 9.3.

Likewise, tailoring the CDCR process for disrupted circumstances also entails considering the difficulties under which the dynamic DRP deployment system is being implemented. As discussed in subsection 2.3, handling disrupted train operations in the vicinity of the disrupted section (i.e. critical area - see subsection 3.6.2) is crucial for the system to transition to stable operations. However, the dense service intervals that are typical in the scheduled operations of a commuter railway network, particularly during peak hours, make it highly plausible that several trains will queue before the LtFTS on either side of the disruption. The queuing of these trains is not the result of a misalignment between the performance limitations of the network infrastructural elements and planned operations but an immediate impact of the disruption. This phenomenon has profound relevance for the entire network, given that until the train queue is resolved, trains in the network will continue to accumulate delays (see subsections 2.3.2 and 2.3.3).

Handling train queues within disrupted operations is a problem that may be approached from different aspects. It is possible to merely focus on resolving the occurring conflicts through, for example, existing CDCR processes (see subsection 2.2.3). However, as discussed in subsection 2.3, the handling of queuing trains, particularly within the critical area, would also benefit from

considering different stations around the disrupted section and taking advantage of their layout (e.g. the possibility to turn turns). Therefore, allowing the assembly of the PVSCS combinations to manage and support the handling of queuing trains in front of the LtfTS while considering the infrastructural layout in the critical area would further enhance the ability of the network to transition to stable operations, as detailed in the requirements (see subsection 3.4.2).

The possibility of exchanging the entrance sequences of inbound queuing trains into the station depends on the number of lines linking the LtfTS. Figure 10.1-A shows some general infrastructural layouts and provides a general example of an entrance sequence of trains to the LtfTS. Figure 10.1-B depicts the way in which an initial entrance sequence, established according to the scheduled arrival of the trains to the LtfTS, is modified to generate a new entrance sequence. Although figure 10.1 depicts a complete blockage, the same principle applies to partial blockages. The higher the number of links connecting the LtfTS, the higher the number of entrance sequences that can be generated. By altering the entrance sequence of queuing trains to the LtfTS (i.e. imposing an additional constraint on the subsequent CDCR processes), the operating situation within the critical area can be handled in different ways until the best alternative is established.

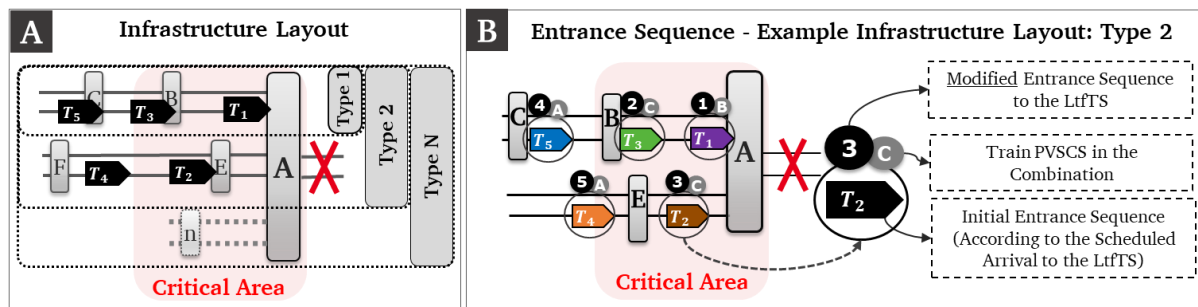

Figure 10.1 Importance of the Infrastructure layout around the LtfTS: A. Generic types of infrastructure layouts; B. Example of the handling of train entrance sequences to the LtfTS for an infrastructure layout type 2 (by author)

Exchanging the entrance sequence of queueing trains in the LtfTS dramatically increases the complexity of the PVSCS combination, as different results can be generated for one single PVSCS combination. While the same principles can be applied to any node (i.e. station or junction) beyond the critical area of the disruption in which different lines intersect paths, this would induce a substantial increase in the complexity of the overall approach and as such an increase of its computational time. Consequently, as the handling of trains within the critical area has a more profound impact on the transitioning of the entire network to stable operations (see subsection 2.3), the standard approach for the dynamic DRP deployment system must focus primarily on the entrance sequences of queuing trains to the LtfTS.

All in all, the PVSCS combination approach to be derived as part of this module must be among other things able to: assemble PVSCS combinations that include a PVSCS for every train circulating in the network per side (if applicable), recognize as well as manage the queuing trains within the critical area and be prepared to handle the complexity introduced by the infrastructural layout. Ultimately, from the requirements discussed throughout this subsection, three sub-problems can be identified:

- i) Assembly of PVSCS combinations that include a PVSCS for every train circulating in the network per side (if applicable) and that purposefully solve the identified line-specific conflicts
- ii) Identification of the queuing trains within the critical area in a PVSCS combination

-
- iii) Handling the queuing trains while considering the infrastructural layout within the critical area

The three sub-problems must be addressed by the module's structured approach.

10.3. Structured Approach for the Combination of PVSCS

The requirements described in subsection 10.2 lay the groundwork for deriving this module's structured approach, supporting the assembly of PVSCS combinations. The structured approach derived in this subsection is mainly focused on addressing the three sub-problems established by the requirements detailed in subsection 10.2.

While the approach must be tailored to address the requirements discussed as part of the dynamic DRP deployment system, it should be noted that the principles behind the core tasks at hand (i.e. assembly of PVSCS combinations, handling the entrance sequence of potentially queuing trains to the LfTS) are not different to any other standard combinatorial problem. Combinatorial processes have been widely researched. Therefore, an overview of the state of the art approaches aimed at addressing the established sub-problems must be performed.

Each of the three sub-problems must be addressed during the assembly of the PVSCS combinations. Therefore, before the general structure for the PVSCS combination is described as part of the dynamic DRP deployment system, this subsection explores existing approaches for each of the three sub-problems in subsection 10.3.1. A structured approach to assemble the PVSCS combinations inspired by the existing approaches established in subsection 10.3.1 is then discussed in subsection 10.3.2.

10.3.1. Existing Approaches

This subsection explores existing approaches for dealing with the assembly of the PVSCS combinations. The approaches considered are aligned with the requirements and the three sub-problems discussed in subsection 10.2.

The following subtitles discuss the existing approaches to address each of the identified sub-problems and identify the feasible alternatives.

Assembly of PVSCS Combinations

As the first and central sub-problem, existing approaches that deal with combinatorial problems within the framework of the PVSCS combination requirements are considered. Particular attention is paid to approaches that are relevant to similar combinatorial problems as those addressed in this module.

Overall, depending on their complexity and their implementation field, combinatorial problems can be addressed through exact and heuristic and metaheuristic methods. However, despite their inability to secure that the best possible solution, the field of complex combinatorial problems has consistently relied on practical metaheuristic techniques for the exploration of a vast search space (Affenzeller and Mayrhofer 2002).

In the context of the PVSCS combination, the search space consists of the number of PVSCS in each of the train's PVSCS sets at its lowest level and, ultimately, the aggregated number of the PVSCS for all trains circulating in the network. Therefore, the search space of the PVSCS

combination is relatively extensive and complex, as can be appreciated in the likely number of PVSCS that may be introduced in a train's PVSCS set discussed throughout section 9.

For practical combinatorial problems with extensive search spaces, there is potentially more than one global optimum solution and significantly more locally optimal solutions (Hillier and Lieberman 2001). It has been argued that there are three prominent types of metaheuristic algorithms that allow addressing complex practical combinatorial problems with extensive search space in a much more effective and efficient manner. These are: Tabu Search, Simulated annealing and Genetic algorithms (Hillier and Lieberman 2001, Affenzeller and Mayrhofer 2002). While the approaches have been introduced in subsection 3.5.1, a brief description of each of them is provided.

- *Tabu Search*: introduced by F. Glover (1989), the method focuses on essential portions of the search space by rendering the least important portions Tabu. The Tabu Search starts by computing one initial solution. Through an iterative technique, it moves from one solution to the next so as to efficiently reach the optimal or near to optimal solution as dictated by the utilized objective function. The key element of the approach is the built-in short term memory of the heuristic that allows it to keep track of recent moves so as to avoid cycling back to already visited areas in the search space (Glover et al. 1993)
- *Simulated Annealing*: introduced by Kirkpatrick et al. (1983), the method is inspired by the physical annealing process, relying on a stochastic optimization technique. The method starts by computing a random initial solution and then moves to the neighbouring solution that better satisfies objective function. However, the best solution is not always selected. There is a probabilistic value that allows the algorithm to occasionally select a different solution, to avoid getting stuck in a local optimum. This value is reduced with each evaluation, decreasing the probability of selecting an inferior solution (Kirkpatrick et al. 1983)
- *Genetic Algorithm*: introduced by J. Holland (1975), the method utilizes a population-model inspired by the principles of “the survival of the fittest” and natural selection. The Genetic algorithm starts by randomly establishing a population, where each individual has its own genetic information that can be evaluated with respect to the objective function. The initial population is replaced by a new generation through crossover and mutation of its best individuals until a termination condition is fulfilled (Holland 1975).

Each of the above-described metaheuristics supports the generation of complete PVSCS combinations as required in subsection 10.2; thus, each of them stands as plausible options for the core of the combination process of the dynamic DRP deployment system. While each of the approaches has its advantages and disadvantages, one of the methods is better aligned with the general limitations of the system. Since Genetic algorithms can handle simultaneously multiple solutions by means of its characteristic population set, it is easy to evaluate more extensive sections of the search space. Whereas the other two algorithms can be retrofitted to support some sort of parallel processing, this feature is already covered in Genetic algorithms, and it does not require further modifications.

Identify Queuing Trains Within the Critical Area in a PVSCS Combination

The second sub-problem focuses on identifying which of the specific PVSCS in the combination steer trains through the critical area, making them interact with other trains in such a way they generate a train queue before the LtFTS. The train queues are only generated since the LtFTS has a

limited capacity to handle all trains that need to be either turned or driven through the station to reach the opposite side. Queuing trains are identified to allow exchanging their entrance sequence to the LtTTS with the purpose of exploring different entrance sequence alternatives that are more conducive towards a transition to stable operations, as argued in subsection 10.2. As discussed in subsection 2.3.3, a DRP can only reach stability if the capacity consumption at its critical elements (e.g. turning stations) is lower or equal than one (i.e. $\rho \leq 1$).

As discussed in subsection 2.2.4, the capacity to handle a certain number of trains within a given time period at a specific location of the network is essentially an evaluation of the performance of the railway facilities under consideration. Overall, three general methods for performance evaluation have been discussed, namely, analytical, constructive or simulation methods (see subsection 2.2.4).

Since every PVSCS combination would include the necessary spatiotemporal information of every train that reaches the critical area, it may be possible to evaluate the capacity consumption (ρ) of the LtTTS utilizing either constructive or analytical methods. However, since the assembled PVSCS combinations still need to be made conflict-free (i.e. fixed) through the CDCR process, the evaluation of capacity would need to track every step taken by the CDCR process and consider the modification induced every time a conflict resolution is introduced.

Consequently, rather than depending on an accurate prognosis of capacity consumption at the LtTTS utilizing existing methods for performance evaluation (see subsection 2.2.4), the train queue within the critical area in a PVSCS combination may be established by advancing a special heuristic approach. The heuristic approach can be based on a series of assumptions that allow establishing potential queuing trains for every assembled PVSCS combination.

For example, it is possible to assume that every train containing the LtTTS in their PVSCS has the potential to form part of the train queue for an investigated PVSCS combination. Utilizing a heuristic approach instead of more formal and exact approaches (as postulated in the example) would also simplify the identification of the queuing trains in front of the LtTTS as part of the structured approach.

Handling the Queuing Trains while Considering the Infrastructural Layout (Dynamic Junction Rescheduling)

Last but not least, existing approaches that address the sub-problem of modifying the entrance sequences of queuing trains to the LtTTS are discussed in this subsection. This sub-problem is similar to the proposed dynamic junction rescheduling problem, investigated by Fan et al. (2012) and later by Eaton et al. (2015).

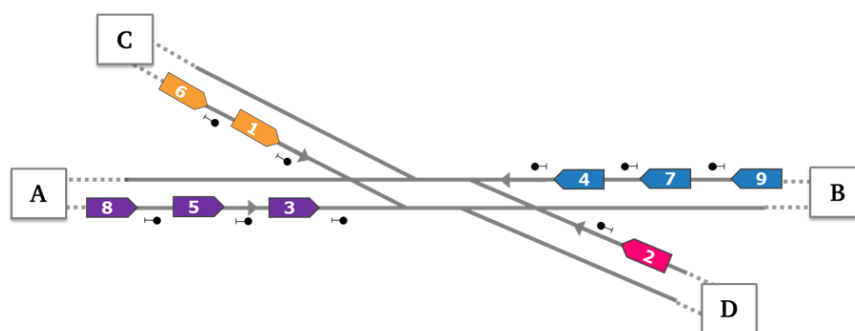

Figure 10.2 Example of the dynamic junction rescheduling problem for nine trains; the colours and numbers represent the sequence constraints between trains on each link connected to the junction (Fan et al. 2012; modified by author)

The work of Fan et al. (2012) proposes a benchmark rescheduling scenario for dealing with a dynamic junction rescheduling problem, in which a conflict-free schedule needs to be derived for all incoming trains affected by a disturbance. Figure 10.2 presents a simplified overview of the benchmark rescheduling scenario addressed by the authors. The assessed scenario consisted of a total of twelve trains distributed across four merging links and four circumstances where different delays were imposed on specific trains. Abiding by the railway operational constraints (i.e. minimum headway times and journey times), the scheduled order of the trains through the junction is systematically adjusted and assessed, to establish which adjusted order delivers the minimum delay.

Overall the junction rescheduling problem also falls within the category of previously discussed combinatorial problems and has been addressed through a series of methods, including metaheuristic algorithms. Fan et al. (2012) endeavoured a systematic assessment of their benchmark scenario using eight different optimization techniques. The methods employed to tackle the problem ranged from exact methods to more complex metaheuristics, namely, brute force algorithms, First Come First Served (FCFS), dynamic programming, decision-tree based elimination, ant colony optimization algorithm, Tabu Search, Simulated annealing, and Genetic algorithms.

The study found that although the best solutions for the twelve trains were computed through exact approaches (i.e. brute force algorithm and the dynamic programming), the computation time was also considerable. Furthermore, since it explored only one solution, the FCFS approach was the quickest vis-à-vis its computational time, yet it provided a suboptimal solution. Nonetheless, the FCFS approach has been highlighted of particular use as a means to acquire a starting solution within the metaheuristic algorithms that have been evaluated. Moreover, the utilization of a Tabu Search algorithm provided the best option among all evaluated metaheuristic algorithms for a trade-off between accuracy and computation time. The main advantage of the Tabu Search was that it improves efficiency through low computation time, as it relied on situation heuristics.

Within the dynamic junction rescheduling problem, the sequence of trains on each incoming link cannot be exchanged, thus imposing a constraint on the resolution process. These sequences cannot be altered since the overtaking of trains driving on the same incoming link is not a possibility. For example, as can be appreciated in figure 10.2, the train sequence on the incoming link from “A” is restricted to 3-5-8 and fixed as such. In its search of a neighbouring solution, the proposed Tabu Search randomly swaps a train pair to create a new sequence through the junction, resulting in a high probability that this will generate unfeasible solutions. For example, if a random swap selects a train pair (3-9) on an initial sequence (1-2-3-4-5-6-7-8-9) through the junction as depicted in figure 10.2, the resulting sequence will be: 1-2-9-4-5-6-7-8-3. The resulting sequence is unfeasible since it presupposes that trains 5 and 8 will drive-through the junction before train 3. Fan et al. 2012, introduced a simple situation heuristic that amends unfeasible entrance sequences (i.e. entrance sequences not aligned with train sequence constraints for each incoming link) resulting from random swaps.

The amending heuristic can be summarized in four steps (Fan et al. 2012, p.30):

0. The candidate train pair to be swapped is randomly selected, the train order in the sequence is swapped, and a potential sequence is generated.
1. The sequence constraints on every incoming link to the junction are acknowledged.

2. Beginning with the first train in the sequence, its feasibility vis-à-vis the sequence constraints of the train's on its corresponding link connected to the junction are assessed.
3. If the train fails to agree with the sequence constraints, it is pushed down the sequence until the first point where it fulfills its constraints.
4. The process returns to step 2 until all trains in the sequence are verified.

One iteration of the amending heuristic proposed by Fan et al. (2012) is depicted in figure 10.3. However, if thoroughly applied to the above-explained example utilizing the layout in figure 10.2 to derive the rest of the sequence constraints for all links, the amended train sequence would result in: 1-2-4-6-7-9-3-5-8.

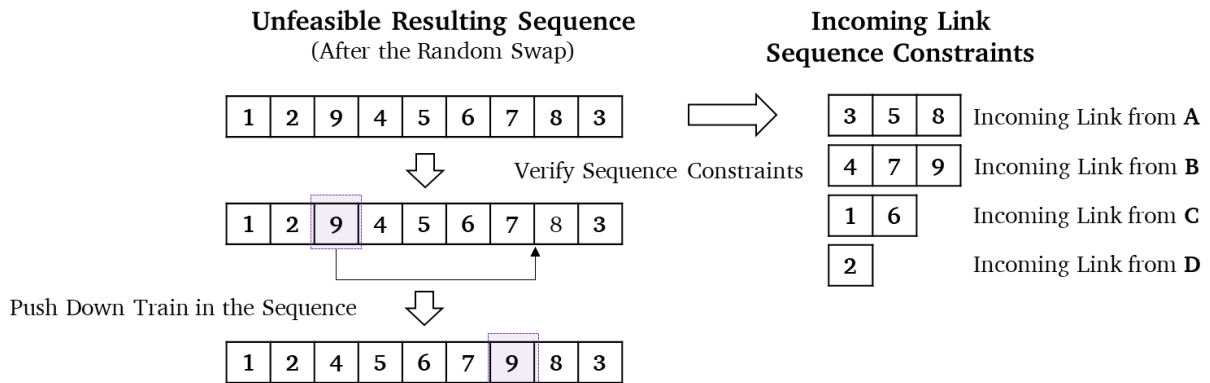

Figure 10.3 Heuristic for amending unfeasible train sequences (Fan et al. 2012; modified by author)

The approaches utilized to address the dynamic junction rescheduling problem addressed in Fan et al. (2012) are highly relevant to the third and final sub-problem dealt with in the PVSCS combination module. Overall, it supports the capability to directly alter the entrance sequence of queuing trains to the LtFTS so that an objective function can be better satisfied.

All in all, the benchmark scenario proposed by Fan et al. (2012), allows generalizing the use of a Tabu Search and its situation heuristic as proficient means to address the third sub-problem. Furthermore, the potential application of FCFS principles for establishing the initial entrance sequence of queuing trains to the LtFTS should be considered.

Summary

In this subsection, an approach has been identified to address each of the three sub-problems identified in subsection 10.2.

- i) Due to the extent of the combinatorial problem being addressed, an existing metaheuristic approach has been chosen for the assembly of PVSCS combinations, namely, a Genetic algorithm. The Genetic algorithm has been chosen due to its ability to handle large population sets and to cover more extensive areas of the search space.
- ii) Since the PVSCS combinations are assembled utilizing specific train PVSCS that need to be fixed by a CDCR, the identification of the queuing trains before the LtFTS is conducted by introducing a heuristic approach.
- iii) For handling the queuing trains while considering the infrastructural layout around the LtFTS, an existing approach that solves a similar problem has been identified. The dynamic junction rescheduling investigated by Fan et al. (2012) and later by Eaton et al. (2015) is utilized as a foundation to manage the entrance sequence of queuing trains to the LtFTS.

The authors discuss the benefits of utilizing a Tabu Search to modify the scheduled sequence through a junction during disturbed operations.

10.3.2. Structured Approach for the Combination of PVSCS

The approaches considered in the previous subsection have laid the groundwork for the establishment of the PVSCS combination process aligned with the requirements detailed in subsection 10.2. This subsection merges the chosen approaches for addressing every single one of three sub-problems and places them in the context of the assembly of the PVSCS combination, thereby providing a structured approach to assemble the PVSCS combinations.

Initially, as with most processes in the dynamic DRP deployment system, the assembly of the PVSCS combinations must first be set to support the disrupted situation (see subsection 5.3). For partial blockages, the PVSCS combinations are assembled for the whole network. In cases of complete blockages or when the DRP operating concept foresees the handling of two different sides, the assembly of PVSCS combinations is performed for each side separately but simultaneously to guarantee that aspects like transfers of trains between sides can be supported on both sides.

Furthermore, the Genetic algorithm is utilized for managing the assembly of individual PVSCS from the sets of PVSCS of every train circulating in the network; thus, it constitutes the foundation of the structured approach as the exploring engine. Additionally, a Tabu Search with its characteristic built-in memory and strategic moves is set to establish an optimal entrance sequence of all potentially queuing trains before the LtfTS from a specific PVSCS combination by paying close attention to the infrastructure layout. It must be highlighted that the Tabu Search can be left aside in cases where the LtfTS has an infrastructure layout type 1, as depicted in figure 10.1. Finally, in order to establish the potentially queuing trains before the LtfTS from a specific PVSCS combination, a heuristic approach must be derived.

There are multiple possible ways to combine the metaheuristic algorithms and derive a general approach for generating the PVSCS combinations. In overall, three general alternatives have been recognized:

- Isolating the combinatorial problems in two different but dependent sub-problems: this alternative handles the assembly of the PVSCS combinations separately from the establishment of the best entrance sequence of potentially queuing trains to the LtfTS. This implies that the Tabu Search algorithm in charge of steering the exploration of different entrance sequences to the LtfTS would be closely related to the CDCR and assessment processes (see sections 11 and 12, respectively) rather than to the Genetic algorithm in charge of assembling the PVSCS combinations. This alternative requires the structured approach to ensure the interaction and communication between the Tabu Search algorithm, the Genetic algorithm and the CDCR process as well as assessment processes.
- Combining both combinatorial problems into one general problem: in this alternative, PVSCS combinations are generated by considering the entrance sequence of queuing trains to the LtfTS. Therefore, the assembly of the PVSCS combinations by means of the Genetic algorithm must be structured so as to simultaneously handle the entrance sequence of potentially queuing trains to the LtfTS. This alternative requires a Genetic algorithm to have the Tabu Search algorithm within its structure.

- Separating the handling of the entrance sequence to the LtfTS between queuing and non-queuing trains: this approach could also be coupled with any of the two options detailed above. As such, the approach not only requires separating the assembly of PVSCS combinations between queuing and non-queuing trains but also the later CDCR and assessment processes. Since the approach fails to fulfill the explicit requirement to generate complete PVSCS combinations (i.e. PVSCS combinations that include all trains - see subsection 10.2), it can be immediately discarded.

Between the two first alternatives, the combination of both problems (second alternative) would derive in a much more complex process without any benefit to the accuracy of the resulting PVSCS combination alternatives. Nevertheless, given that the exploration of the search space would inherently consider the modified entrance sequences of queuing trains to the LtfTS, the computational time can result to be much more reduced. On the other hand, by keeping the algorithms independent from one another, the modular structure of the whole system is upheld, and the computational time deficiencies can be addressed by making the Tabu Search algorithm much more efficient in its dealings with the combinatorial problem.

Among the considered possibilities, the first alternative is utilized to arrange the structure of this module's approach. As a result, the structured approach is constituted by two metaheuristic algorithms and complemented by the establishment of an initial PVSCS combination, as depicted in figure 10.4.

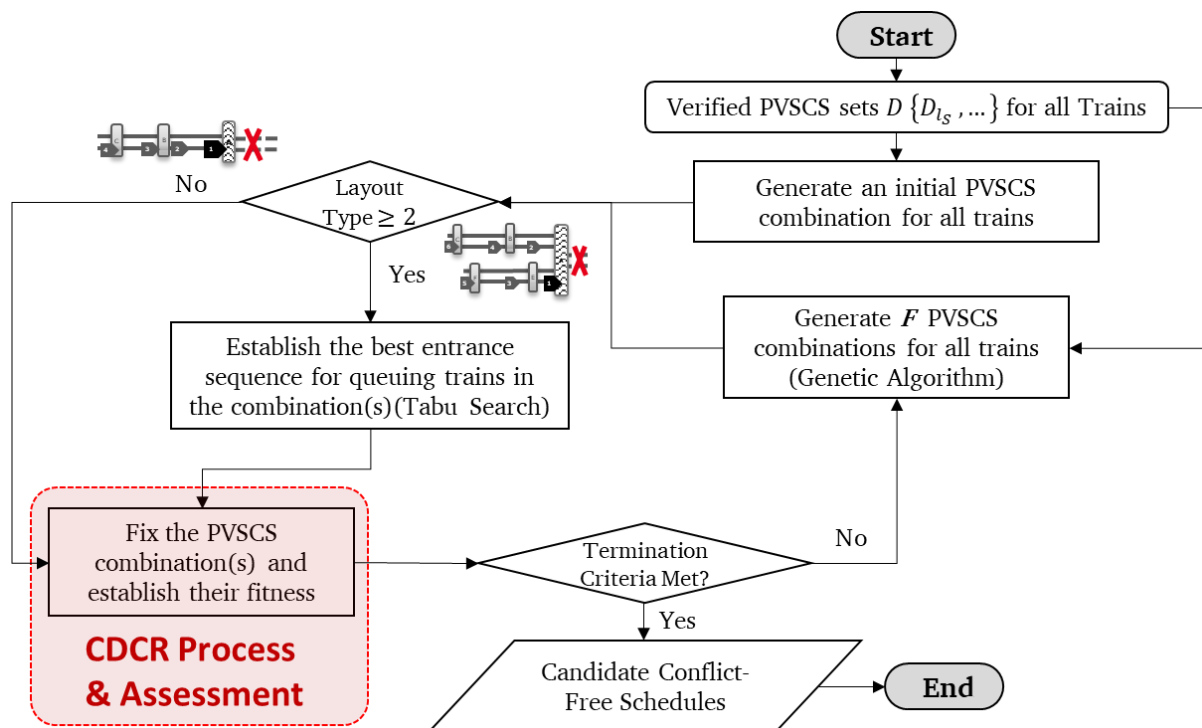

Figure 10.4 Structured approach for the combination and handling of PVSCS (by author)

The general outline of the PVSCS combination process can be divided into three overall steps.

1. As a starting point, an *initial PVSCS combination* (subsection 10.4) is assembled through a guided selection of PVSCS for all trains from their respective PVSCS sets.
2. The *Tabu Search* then refines the initial PVSCS combination (subsection 10.5), exploring an optimal entrance sequence of all potentially queuing trains to the LtfTS. If the

infrastructure around the LtfTS has a layout type 1 (see figure 10.1), the Tabu Search algorithm is not required to establish an optimal entrance sequence (see figure 4). Within the Tabu Search algorithm, the potentially queuing trains are ascertained through a *heuristic approach*, and the exploration of the best entrance sequence starts with an entrance sequence derived utilizing an FCFS principle. Every entrance sequence is transferred to the CDCR process as a constraint that must be utilized during the fixing (i.e. making the PVSCS combination conflict-free) of the PVSCS combination (see section 11). The fitness of the resulting conflict-free PVSCS combination solved utilizing a given entrance sequence is assessed (see section 12) and returned to the Tabu Search algorithm to keep exploring different alternatives (i.e. entrance sequences) (see figure 3.1).

3. The *Genetic algorithm* (subsection 10.6) incorporates the refined *initial PVSCS combination* solution as its upper bound for the development of an initial population of PVSCS combinations. From this point on, the initial population of the Genetic algorithm (i.e. an initial set of assembled PVSCS combinations) evolves, applying the *Tabu Search* algorithm at every step (if needed) to obtain the best possible entrance sequence to the LtfTS for queuing trains in every assembled PVSCS combination. The Genetic algorithm explores the search space by assembling PVSCS combinations until the termination criteria are met. Once the termination criteria are met, all the assembled PVSCS combinations in the Genetic algorithm's current population, contain the candidate conflict-free schedules. This marks the final product of the dynamic DRP deployment system and the achievement of its ultimate objective (see subsection 3.5.3).

The three steps discussed above constitute the structured approach for assembling the PVSCS combinations. Each of the steps is further detailed in the forthcoming subsections laying the groundwork to support the subsequent handling of the PVSCS combinations within later modules of the system. In the first instance, discussed in subsection 10.4, a closer look at the establishment of an initial PVSCS combination (i.e. upper bound) is provided. Thereafter, with the upper bound established, the assembly of the PVSCS combinations by means of the two metaheuristic algorithms is discussed in further detail in subsections 10.5 and 10.6.

10.4. Establishing an Initial PVSCS Combination

The first step within the structured approach for the assembly of PVSCS combinations is the establishment of an initial PVSCS combination. With the help of the initial PVSCS combination, the structured approach is able to establish an upper bound later utilized as a benchmark for the assembly of further PVSCS combinations. This subsection details the process for the establishment of the initial PVSCS combination.

The initial PVSCS combination is particularly relevant to the effectiveness of the structured approach since its fitness is later utilized as a baseline for assembling the PVSCS combinations that constitute the first generation of the Genetic algorithm. Therefore, the selection process for each of the PVSCS in the set $D \{D_{i_s}, \dots\}$ is of critical importance for the assembly of the initial PVSCS combination.

The selection of the PVSCS in the PVSCS set of every train for the establishment of the initial PVSCS combination ought to be conducted in such a way that the resulting PVSCS combination is representative of the whole disruption-management process. Consequently, the establishment of

the initial PVSCS combination requires to derive some guiding principles that allow selecting specific PVSCS from the PVSCS sets of every train.

Subsection 10.4.1 provides a detailed discussion on the guiding principles utilized for the selection of the initial PVSCS combination. Later, the process for a guided PVSCS selection is detailed in subsection 10.4.2.

10.4.1. Deriving the Guiding Principles for the Selection of PVSCS

The establishment of an initial combination should select specific PVSCS $d_{T_{l_s,i}}$ from the PVSCS sets $D_{T_{l_s,i}} \{d_{T_{l_s,i}'}, \dots, z_{T_{l_s,i}}\}$ of each of the trains in the network until one PVSCS has been selected from every subset in the superset $D \{D_{l_s}, \dots\}$. This subsection outlines an approach for the guided selection of PVSCS in the PVSCS sets towards the establishment of the initial PVSCS combination.

It is essential to consider two important aspects during the selection process. First, the PVSCS sets $D_{T_{l_s,i}} \{d_{T_{l_s,i}'}, \dots, z_{T_{l_s,i}}\}$ of each train cover an ample range of possibilities, which complicates the selection of only one representative PVSCS. Second, trying to project the implementation of single PVSCS on the actual operating situation of the network is relatively limited since the interaction with other trains has not been considered during their development (see subsection 9.5). Consequently, it is difficult to establish a basis upon which the guided selection of PVSCS can be advanced.

Any method that deals with the problem of projecting the implementation of single PVSCS would be extremely beneficial for establishing the initial PVSCS combination. A closer consideration of PVSCS development (see section 9) processes, may reveal a specific approach to guide the selection of the PVSCS $d_{T_{l_s,i}}$ from the PVSCS sets $D_{T_{l_s,i}} \{d_{T_{l_s,i}'}, \dots, z_{T_{l_s,i}}\}$.

As discussed throughout subsection 9.5 and 9.8, the development of the PVSCS and their subsequent arrangement in the PVSCS set was conducted through an organized selection and combination of isolated elements in three different lists (i.e. line-specific conflict solution, accessible infrastructural elements and potential transition train services). Overall, the PVSCS have been developed utilizing a selection of the line-specific potential conflict solution alternatives established in section 8. Additionally, the order in which the line-specific potential conflict solution alternatives were chosen to develop the PVSCS for every train was aligned with the order in which the line-specific conflict solution alternatives have been assessed for the classification (i.e. utilizing the hierarchical structure derived in subsection 6.4 – see subsection 8.5). The selection of the further elements that constitute a PVSCS, namely, accessible infrastructural elements and potential transition train services to adjust the circulation plan, were also selected utilizing an organized selection, supported by the operational verification (see subsection 9.7). Ultimately, the arrangement of the PVSCS within each PVSCS set follows the order in which they have been generated (see subsection and 9.8). Therefore, an adept initial PVSCS combination may be derived by concentrating the selection on the elements within every train's PVSCS set which have been arranged at the beginning of the set.

Focusing the selection of the PVSCS on the elements at the beginning of each of the PVSCS sets prioritizes the use of the line-specific elemental conflict solution measures at the top of the hierarchy detailed in subsection 6.4. Thus, the initial PVSCS combination will be developed with a reduced likelihood that it differs substantially from the original schedule. This is due to the fact

that the PVSCS with more complex conflict solution alternatives or that reach infrastructural elements outside of the commuter railway network (see subsection 9.5) are introduced further down the set's arrangement, and as such, are not selected immediately. Consequently, the selection of PVSCS for the initial PVSCS combination is conducted by selecting the first suitable PVSCS from each of the train's sets.

However, when following this approach, two practical obstacles need to be addressed. Primarily, selecting the first PVSCS in each of the train's PVSCS sets does not guarantee that the resulting PVSCS combination will have PVSCS that are compatible with one another (e.g. train services may be considered more than once). Secondly, in view of the first problem, a clear understanding of what constitutes operationally compatible PVSCS combinations is necessary.

Two general rules help to address these two obstacles, as well as the following definition of operational compatibility for PVSCS combinations:

An operationally compatible PVSCS combination: refers to the set of selected PVSCS that establish a PVSCS combination and together abide with the line-specific conflict list, and have a consistent adjustment of their circulation plans.

- Abiding by the line-specific conflict list entails observing that the PVSCS combination is aligned with the identified vehicle availability conflicts of a line. Together the PVSCS in the combination must consider (for their respective lines), the number of trains that are foreseen to be incorporated, removed, coupled, decoupled, exchanged between lines or transferred (see subsection 8.4). Additionally, surpassing the limited availability at a parking location must also be accounted for.
 - Having a consistent adjustment of the circulation plan across all the selected PVSCS in the PVSCS combination entails preventing train service are considered more than once and that the coupling and decoupling of trains are compatible between specific vehicles (e.g. the PVSCS of the coupling trains is carefully selected).
- i) *Rule one:* As discussed above, the investigation order discussed in subsection 9.3 can guide the establishment of the order in which the trains have their PVSCS selected from their PVSCS sets. Therefore, indirectly, the order in which the trains have their PVSCS selected is also dependent on the extent of the disrupted situation (i.e. full or partial blockage – see subsection 9.3).
- ii) *Rule two:* Following the investigation order, the PVSCS are selected within each set, starting from the first PVSCS in the set's arrangement. Before the selected PVSCS is introduced in the PVSCS combination, it is assessed to verify if it is operationally compatible with the PVSCS of the trains already in the PVSCS combination.

Together, the definition and the two rules detailed above provide a structure to guide the PVSCS selection process and assemble an initial PVSCS combination from the superset $D \{D_{I_s}, \dots\}$.

Finally, if the selected PVSCS is not compatible, a guideline for ascertaining which of the trains in the PVSCS combination would keep the first PVSCS and which would need to be assigned a different PVSCS is still required.

10.4.2. Guided Selection Process of PVSCS from the Sets

This subsection details the process used to assemble the initial PVSCS combination. The process is derived following the guiding principles derived in subsection 10.4.1.

Individual PVSCS are selected from the PVSCS set of every train in an iterative process following the already established investigation order (see subsection 9.3). The selected PVSCS of every train is introduced in the PVSCS combination, which results in a set $I_{S,o}$. However, before the selected PVSCS can be successfully introduced in the PVSCS combination $I_{S,o}$ its operational compatibility must be verified as detailed in subsection 10.4.1. The initial combination acquires the sub-index o equals 1 (i.e. $o = 1$). As established in subsection 3.5.2 and 10.1, a PVSCS combination has been successfully assembled when one PVSCS for every train has been introduced in the PVSCS combination $I_{S,o}$, depending on the extent of the disruption (i.e. full or partial blockage), the existence of different sides must also be taken into consideration.

Accordingly, the assembly of the initial PVSCS combination is conducted through an iterative process constituted by the four steps detailed below:

1. Starting with the first train in the investigation order ($T_{l_S,i=1}$), the first PVSCS in its set $D_{T_{l_S,i=1}} \{d_{T_{l_S,i'}}, \dots, z_{T_{l_S,i}}\}$ is selected and introduced in the initial combination $I_{S,o=1}$.
2. The next train in the investigation order $T_{l_S,i+1}$ is then considered and the first PVSCS in its set $D_{T_{l_S,i+1}} \{g_{T_{l_S,i+1}'}, \dots, w_{T_{l_S,i+1}}\}$ is selected. If there are no trains left in the investigation order, the process terminates and the initial PVSCS combination $I_{S,o=1}$ is completed.
3. The PVSCS selected in step 2 is verified to check its operational compatibility with pre-existing PVSCS in the combination $I_{S,o=1}$. The verification process determines whether the selected PVSCS is operationally compatible with the line-specific conflict list for its line and searches for any misalignments with trains already included in the PVSCS combination.
 - If it is found that the selected PVSCS is operationally compatible with the existing PVSCS in the combination, it is introduced in the combination $I_{S,o=1}$ and the process circles back to step 2 (see subsection 10.4.1).
 - If the selected PVSCS is found not to be operationally compatible, the next PVSCS in the set is selected and evaluated. This process is conducted until a fitting PVSCS is identified. Once a PVSCS is identified, the process circles back to step 2. If no PVSCS is found, then step 4 must be conducted.
4. If no PVSCS in the PVSCS set of a train is operationally compatible with the PVSCS already introduced in the PVSCS combination, the search returns to the first PVSCS in the train's set and the search is expanded to include the immediately prior train from the same line in the PVSCS combination. The search of the PVSCS shifts the PVSCS of the prior train to the next PVSCS in its set and the process circles back to step 3.

Given the ample range of possibilities, the likelihood that no PVSCS in the set will match the existing combination is minimal. Nevertheless, with the expansion of the search space discussed in step 4, the proposed selection process is capable of addressing such circumstances.

Furthermore, there are two particular cases in which the above-described process must observe some additional steps. In case a transfer is selected, the operational compatibility must also be assessed for trains on the opposite side. As this process is conducted in parallel for both sides, the

verification can be conducted without further problems. In the case of coupling, the first train assigned with this measure will also immediately lock the first compatible PVSCS of its coupling train(s). In this way, the coupling of trains in the initial combination would be guaranteed with the least computing effort.

Before the initial PVSCS combination $I_{S,o=1}$ can constitute the upper bound for the development of the initial population of the Genetic algorithm; it must be introduced within the Tabu Search algorithm (if needed). If the infrastructure layout is Type 1 (see figure 10.1), the initial PVSCS combination can be immediately fixed and its fitness (R^*) assessed, as detailed in sections 11 and 12.

10.5. Optimal Entrance Sequence – Tabu Search

The Tabu Search algorithm is in charge of handling the entrance sequences of potentially queuing trains to the LtFTS. As discussed in subsection 10.2, in case trains arrive at the LtFTS through more than one link (see figure 10.1), each assembled PVSCS combination $I_{S,o}$ should have different entrance sequences explored. The exploration allows identifying the entrance sequence that delivers the most optimal conflict-free schedule as determined by the CDCR and assessment modules. Relying on a Tabu Search algorithm the objective of this subsection is to derive a logical structure to explore a series of entrance sequences for trains queuing around the LtFTS.

Overall, the proposed logical structure handles already assembled PVSCS combinations $I_{S,o}$, which are either assembled by the Genetic algorithm (see subsection 10.6) or established as the initial PVSCS combination $I_{S,o=1}$ (see subsection 10.4). Nevertheless, the handling of PVSCS combinations must always consider the infrastructural layout around the LtFTS. As discussed in subsection 10.2, Type 1 infrastructure layouts (see figure 10.1) do not require to be handled by this algorithm and can be immediately fixed and assessed as detailed in sections 11 and 12.

As discussed in subsection 10.2, the main objective of the Tabu Search algorithm is the exploration of different entrance sequences for trains queuing before the LtFTS within one single PVSCS combination. Since every explored entrance sequence imposes a constraint within the CDCR process, the assessment would deliver conflict-free schedules with different fitness values (see sections 11 and 12). Choosing the entrance sequence that delivers the best fitness value permits to establish the most optimal entrance sequence of trains to the LtFTS for a given PVSCS combination. As a result, the Tabu Search is a critical process within the Genetic algorithm that is in charge of assembling the different PVSCS combinations (see figure 10.4).

The parallels between the benchmark problem addressed by Fan et al. (2012) and the problem being address in this subsection were discussed in subsection 10.3.1. Moreover, it has also been established that the Tabu Search algorithm to be further developed in this subsection would benefit from including elements of the existing approach. This includes the use of an FCFS principle for establishing the algorithm's initial solution and the incorporation of the situational heuristic to amend the resulting entrance sequences not compatible with the train sequence constraints on each incoming link (see subsection 10.3.1).

While certain elements from the existing approach can be utilized, the core of the metaheuristic still needs to be specially tailored for its incorporation within the dynamic DRP deployment system. Therefore, in this subsection, a special Tabu Search algorithm is generated to guide the exploration

of different entrance sequences for queuing trains to the LtfTS as part of the structured approach for the combination of PVSCS.

The overall structure of the Tabu Search is depicted in the logical structure presented in figure 10.5.

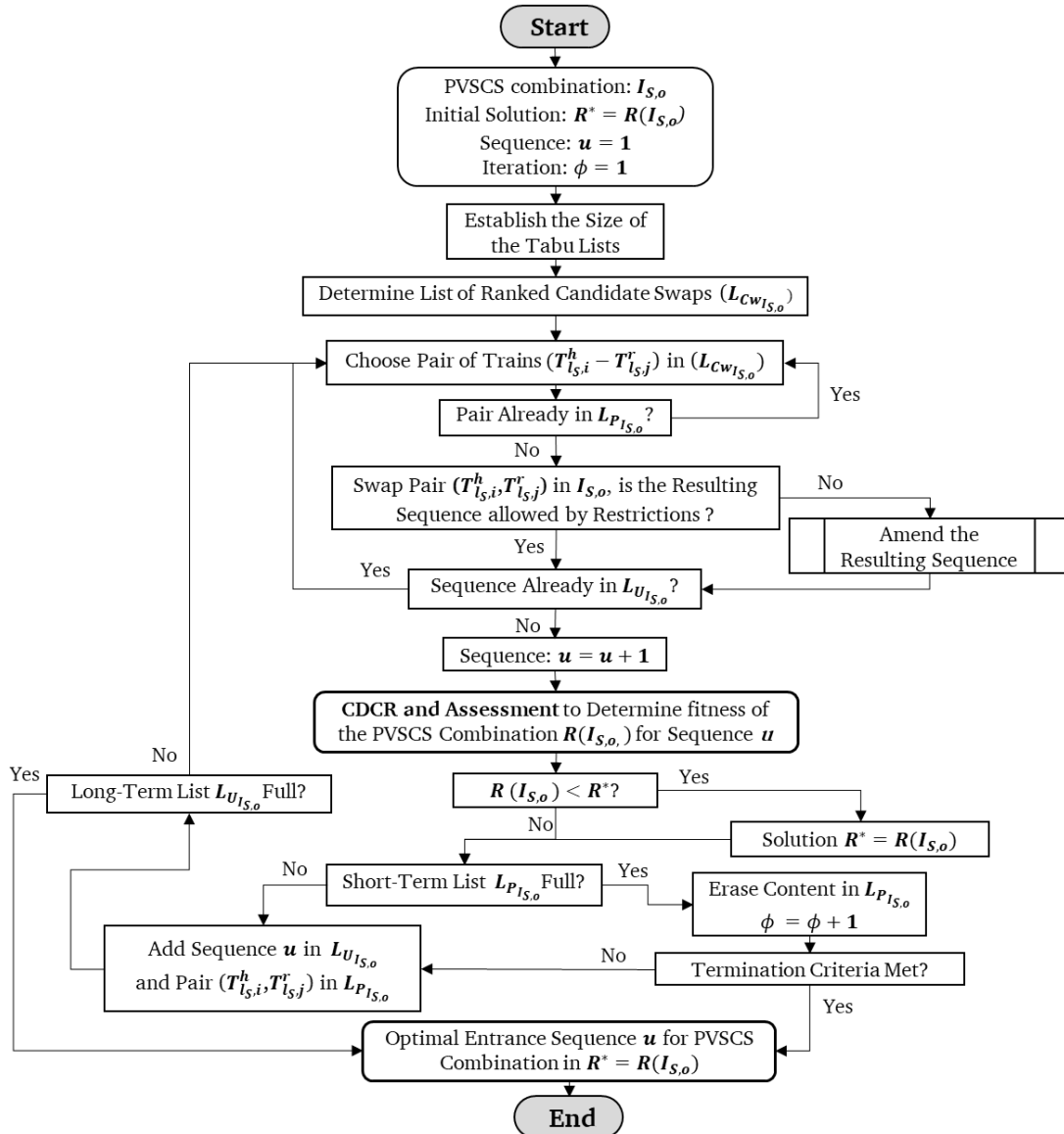

Figure 10.5 Structure of a Tabu Search algorithm for the establishment of the best entrance sequence of potentially queuing trains to the LtfTS (by author)

The exploration of possible entrance sequences of queuing trains to the LtfTS within each PVSCS combination $I_{S,o}$ is steered by the Tabu Search, as summarized in the following ten steps:

1. The fitness of an initial incumbent solution R^* based on an FCFS entrance sequence is computed. The solution is obtained by fixing the PVSCS combination through the CDCR process (i.e. making the PVSCS combination conflict-free - see section 11) whilst respecting the constraints imposed by an FCFS entrance sequence. The fitness of the solution is obtained as detailed in the assessment module (see section 12).
2. The size of two Tabu lists is established, representing the short-term and the long-term memory of the algorithm.

3. The train pairs that can be swapped so as to generate new entrance sequences u are ranked in a list according to the spatiotemporal potentials of the swap.
4. A pair of trains from the ranked list of candidate swaps is randomly selected, and the short-term Tabu list is checked to see if this swap is already recorded. If the swap is on the list, a new pair of trains must be chosen until a swap, which is not on the list is selected.
5. The order of the chosen pair of trains in the last assessed sequence is swapped, and the resulting entrance sequence is verified to ensure that the entrance sequence constraints on every incoming link to the LtFTS are satisfied (see subsection 10.3.1). If the constraints are not satisfied, the situational heuristic proposed by Fan et al. (2012) is used to amend the resulting sequence.
6. The long-term Tabu list is checked for the presence of the resulting entrance sequence u . If the resulting sequence is on the list, the algorithm circles back to step 4.
7. The resulting entrance sequence u of queuing trains to the LtFTS is later employed as a constraint within the CDCR process detailed sections 11. Once the PVSCS combination is conflict-free, the resulting fitness R can then be ascertained, as described in section 12.
8. The fitness R of the fixed PVSCS combination is contrasted against the incumbent R^* . If there is an improvement in the fitness (i.e. $R < R^*$), then the new solution becomes the incumbent.
9. The swap and the resulting sequence are introduced in their respective lists and the algorithm circles back to step 4.
 - If the swap list (i.e. short-term) is full, the list must be erased before the swap is included. Erasing the swap list indicates the end of an iteration and the termination criteria must be verified.
 - If the sequence list (i.e. long-term) is full, the algorithm can be immediately terminated.
10. If the termination criterion is satisfied (i.e. R^* has remained the same after three consecutive iterations), then the Tabu Search has converged and the entrance sequence u in the fixed PVSCS combination $I_{S,o}$ contains an enhanced fitness R^* ; if the termination criterion is not satisfied, the algorithm circles back to step 4.

From the ten steps that constitute the Tabu Search algorithm, five key processes require further detail to secure the entrance sequence u that generates the best fitness as assessed by the evaluation function (see section 12) for every PVSCS combination $I_{S,o}$ can be established.

The five processes start being detailed by a close account of the establishment of the initial entrance sequence (FCFS) discussed in subsection 10.5.1. Later, subsection 10.5.2 describes the process for establishing the long-term and short-term memory of the algorithm. Thereafter, the establishment of a list with ranked candidate swaps is explained in subsection 10.5.3. Next, the selection process of the elements in the ranked list is discussed in detail in subsection 10.5.4. Finally, the termination criteria for the Tabu Search algorithm are covered in subsection 10.5.5.

10.5.1. Establishing the Initial (FCFS) Entrance Sequences for Queuing Trains in a Combination

With a fully established PVSCS combination $I_{S,o}$, either from the initial PVSCS combination (i.e. $I_{S,o=1}$) (see subsection 10.4) or the Genetic algorithm (see subsection 10.6), an initial entrance sequence (i.e. $u = 1$) of the queuing trains to the LtFTS, is determined following an FCFS principle. The initial entrance sequence based on FCFS principles is utilized to establish the initial situation

of the addressed problem and a benchmark to guide the exploration of further entrance sequences. This subsection details the process for determining an initial entrance sequence to the LtfTS for all potentially queuing trains within the investigated PVSCS combination $I_{S,o}$. Additionally, as discussed in subsection 10.3.2, a heuristic approach must also be advanced to establish the potentially queuing trains in front of the LtfTS in the investigated PVSCS combination $I_{S,o}$.

As discussed in subsection 10.3.1, it is not possible to assign an initial entrance sequence exclusively to the queuing trains before the PVSCS combination has been fixed. However, since the entrance sequence to the LtfTS imposes a constraint on the CDCR process, it needs to be determined before the PVSCS combination is fixed. Furthermore, it must be considered that since the PVSCS selected for a given train from its PVSCS set to constitute the PVSC combination can be completely different from another (e.g. rerouting the train outside the commuter railway network in the nearest deviation point vs. turning the train at the LtfTS), the initial entrance sequence has to be established every time a new PVSCS combination is investigated. A heuristic approach is introduced as a way to address this discrepancy, which permits to allocate an entrance sequence to all trains that may potentially be included in the train queue.

To identify the potentially queueing trains within the investigated PVSCS combination $I_{S,o}$, it is necessary to isolate all trains that can be involved in the queue. Therefore, any train that contains the LtfTS in its PVSCS may be considered a potentially queuing train. Nonetheless, since a train can have the LtfTS assigned more than once throughout its adjusted circulation plan, a limit must be established. Thus, only a train's first scheduled arrival at the LtfTS, as detailed by its PVSCS, is taken into consideration. In this way, it may be guaranteed that at least every train's immediate arrival at the LtfTS is considered and the handled sequences are limited in size. However, depending on the computational effort available, this principle can be changed to include a wider or tighter range of trains. For example, a much more restrictive limit could foresee considering the first arrival, but only of trains clustered within the Green and Yellow categories.

Having recognized all potentially queueing trains, the initial entrance sequence ($u = 1$) is established following an FCFS principle. Therefore, following every train's PVSCS in the investigated combination, their scheduled arrival time at the LtfTS would permit to establish the initial entrance sequence ($u = 1$) by arranging the arrival time synchronously. Ultimately with every train in the PVSCS combination assigned a position in the FCFS entrance sequence, the PVSCS combination $I_{S,o}$ with sequence $u = 1$ is established as depicted in the bottom of figure 10.6.

Figure 10.6 depicts an example for the entrance sequence per incoming link q to the LtfTS and the total number of potentially queueing trains H that are being handled. Both features are attained by fixing an initial entrance sequence ($u = 1$) as the initial situation and assigning a fixed order h to every potentially queuing train in the investigated PVSCS combination. The order assigned in the initial situation (i.e. FCFS) to every potentially queuing train $T_{I_{S,i}}^h$ can also be extended to every train's PVSCS $d_{I_{S,i}}^h$ in the investigated PVSCS combination $I_{S,o}$.

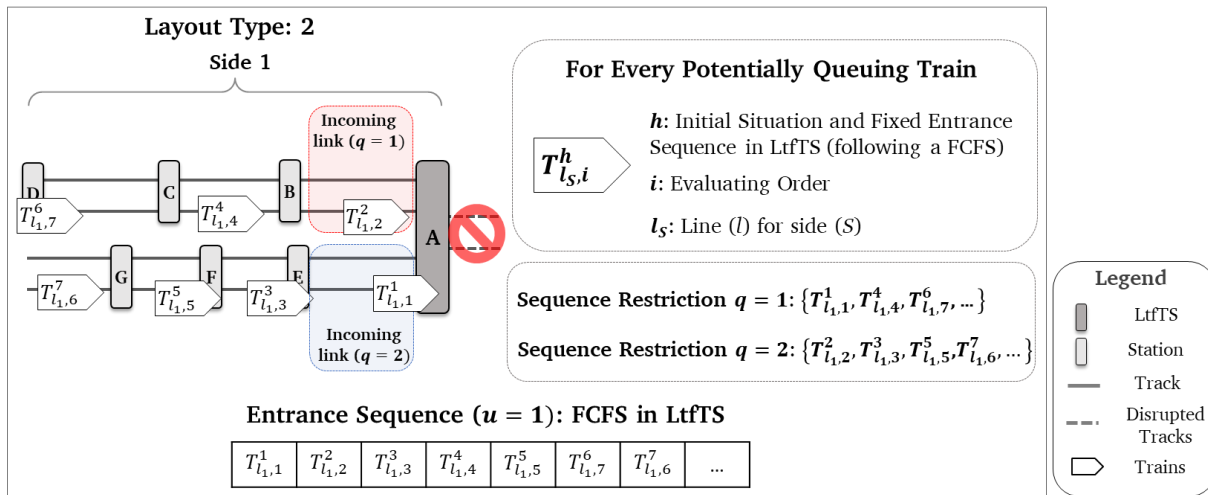

Figure 10.6 Example of an initial entrance sequence of all potentially queuing trains to the LtfTS based on FCFS principle and abiding by the sequence restrictions per incoming link to the LtfTS (by author)

The above-described process allows establishing the initial entrance sequence for queuing trains following an FCFS principle for any PVSCS combination $I_{S,o}$. The initial entrance sequence (i.e. $u = 1$) provides a framework in which all future entrance sequences are generated. Any prospective sequences generated in later iterations of the Tabu Search will exchange the order of the trains based on their position in the initial situation h and constrained by the train sequences on every incoming link q (i.e. no overtaking of trains across the same incoming link).

10.5.2. Determining the Size of the Tabu Lists

The existence of the long and short-term Tabu lists provides the algorithm with its distinctive memory, which allows it to better explore the search space. In the context of the entrance sequences for queuing trains to the LtfTS, the search space is given by the number of swaps and the number of sequences that can be generated. The infrastructural layout and the entrance sequence constraints per incoming link must be considered in order to derive the respective number of swaps and sequences that may be generated. Consequently, the swaps and the entrance sequences, each constitute a fraction of the algorithm's memory. This section details the overall approach to establish the length of the long-term and short-term Tabu lists.

The long-term memory keeps track of the entrance sequences. Once an entrance sequence has been generated and assessed, it is possible to render it Tabu by including it in the sequence list. This would prevent a sequence to be assessed more than once, wasting computation time. The list is defined as long-term since it is not erased as the algorithm is performed, and once it is full, the algorithm must be terminated.

The total number of possible entrance sequences remains as a function of the total number of queuing trains H and the total number of trains per incoming link connecting to the LtfTS H_q . Therefore, the total number of entrance sequences U for a given PVSCS combination $I_{S,o}$ can be computed as in equation 10.1 (see Mladenović 2019). The total number of entrance sequences U represents the total size of the search space.

$$U_{I_{S,o}} = \frac{H!}{H_1! * H_2! * \dots * H_q!} \quad (10.1)$$

Nevertheless, so as to impose further constraints on the algorithm, the length of the long-term memory can be reduced by a parameter X_0 , as detailed in equation 10.2. However, since a termination criterion will be set in place, the size of the long-term Tabu list $L_{U_{I_{S,o}}}$ can be maintained equal to the total size of the search space; thus, $X_0 = 1$. Nevertheless, depending on the computational effort and the number of potentially queuing trains that are being handled, the parameter X_0 can be assigned values between 0.8 and 0.4. This would indicate that if the termination criteria are not met, the algorithm can be terminated once the selected shear of the search space has been explored (Glover et al. 1993). This is only possible if robust exploration strategies for the algorithm are advanced (see subsections 10.5.3 and 10.5.4).

$$L_{U_{I_{S,o}}} = U_{I_{S,o}} * X_0 \quad (10.2)$$

The short-term memory, on the other hand, is constituted by the possible number of swaps between train pairs that can be executed after contemplating the way in which the queuing trains are arranged across the infrastructure. Therefore, this list tracks the actual moves of the algorithm in the search space. As depicted in figure 10.6, there are sequence constraints on every incoming link q that cannot be infringed, since trains will not overtake one another. Therefore, respecting the sequence constraints on the incoming links and the number of trains per link H_q , the total number of swaps $P_{I_{S,o}}$ can be ascertained as in equation 10.3 (Mladenović 2019).

$$P_{I_{S,o}} = \frac{H!}{2(H-2)!} - \frac{H_1!}{2(H_1-2)!} - \dots - \frac{H_q!}{2(H_q-2)!} \quad (10.3)$$

The short-term memory can be allocated a size to explore all possible neighbouring movements, as in equation 10.4. Since the short-term list keeps track of the algorithm iterations, a short-term list that includes all possible swaps would foresee a very exhaustive exploration of the neighbouring solutions.

$$L_{P_{I_{S,o}}} = P_{I_{S,o}} \quad (10.4)$$

Nevertheless, so as to make the algorithm more efficient in its exploration of the search space, the short-term memory can also be truncated. Current applications in permutation problems that allow the swapping of only two members at a time highlight that the short-term Tabu list size should be kept around a quarter of the total elements in the dimension of the problem. However, this number can be further reduced depending on the computational effort available (Tsubakintani and Evans, 1998). Therefore, for practical purposes the size of the short-term Tabu list $L_{P_{I_{S,o}}}$ can be ascertained as a function of the total number of potential queueing trains H , as in equation 10.5.

$$L_{P_{I_{S,o}}} \cong \left\lfloor \frac{H}{4} \right\rfloor \sim \left\lfloor \frac{H}{5} \right\rfloor \quad (10.5)$$

However, contingent on the magnitude of the problem at hand, the short-term candidate list should not be made too small either. Glover et al. (1993), recommend that the short-term list ought not to be reduced beyond 7 to 5 elements. Therefore, the short-term list should be accordingly sized, as detailed by the following equation 10.6.

$$L_{P_{I_{S,o}}} \cong \begin{cases} \left\lfloor \frac{H}{4} \right\rfloor \sim \left\lfloor \frac{H}{5} \right\rfloor, & \text{if } H \geq 30 \\ 7 \sim 5, & \text{if } H < 30 \end{cases} \quad (10.6)$$

10.5.3. Ranking Candidate Swaps in a List

The ranking of the candidate swaps (i.e. moves) allows the algorithm to prioritize movements that have a higher likelihood to derive in a betterment of the incumbent solution. Like this, the computation time can be reduced, and the exploration of the search space can be made more robust by observing the actual operational circumstances of the queuing trains (Glover et al. 1993).

Within the context of the problem being tackled in this section, establishing the best swaps entails identifying which train pairs may derive in a sequence with better fitness as established by the evaluation function. To perform this task, there are multiple determining variables within each of the queuing trains' PVSCS that can be considered. Determining variables like occupancy times or the capacity at the station before and after the swap of a particular pair of trains would be of utter importance. However, the ability to evaluate these determining variables is limited, since the PVSCS combination still needs to be fixed. Therefore, further determining variables within each of the selected train's PVSCS in the combination must be contemplated.

In this regard, the spatiotemporal components of the PVSCS in the combination, which have been contemplated during their development and discussed in subsection 9.5.1, become of relevance. For every pair of trains whose swap abides with the entrance sequence constraints per incoming link q to the LtFTS, the spatiotemporal components of their PVSCS (e.g. routes, arrival, departure times) within the critical area can be easily contrasted.

There are three essential spatiotemporal characteristics within the PVSCS of every pair of trains that can be contrasted. Initially, the closer the trains are scheduled to arrive at the LtFTS as detailed in their PVSCS, the higher the likelihood their swap would benefit the CDCR process, and a better solution for the PVSCS combination can be acquired. Such circumstances take place due to the constraints introduced by the altered sequence that will prevent a train from entering the station, even though it is scheduled to arrive before the previous train in the sequence. Furthermore, by restricting their entrance, swapping trains that not only have a similar arrival time to the LtFTS but also that have the same platform track assigned in their PVSCS may prove to be even more effective. In the same way, swapping the entrance order of trains with conflicting entrance routes through the switching zones to the station may also lead to the establishment of better solutions for the PVSCS combination during the CDCR process (see section 10). The occupancy time of the trains at the platform track can also be utilized to decide if a swap may be beneficial or not. Since the PVSCS have been developed considering an empty network (see subsection 9.2), the occupancy time of the platform track would be a characteristic with the sufficient accuracy to reflect the benefit of a swap.

Conclusively, to rank the candidate swaps, the PVSCS for every pair of trains whose swap abides with the entrance sequence constraints are contrasted to ascertain their spatiotemporal characteristics. After contrasting the spatiotemporal characteristics of the PVSCS of the investigated pair of trains, these can be introduced in the ranked list $L_{CWIS,o}$ of the PVSCS combination. The ranking process may be designed as a hierarchical algorithm that focuses first on the temporal and later on the spatial characteristics of the PVSCS of the investigated train pairs. This is due to the fact that the temporal characteristics would allow a better grasp of the potential betterment to the solution induced by a swap, as discussed above.

The contrasting and ranking process is conducted in seven steps, as detailed below.

1. A temporary set of all train pairs $T_{l_s,i}^h - T_{l_s,j}^r$ whose swap abides with the entrance sequence constraints must be established.
2. A train pair $T_{l_s,i}^h - T_{l_s,j}^r$ is randomly selected from the temporary set.
3. The difference in the scheduled arrival time $a_{T_{l_s,i}^h - T_{l_s,j}^r}$ at the LtfTS for a train pair according to their PVSCS is computed, as in equation 10.7.

$$a_{T_{l_s,i}^h - T_{l_s,j}^r} = \left| t_{Scheduled.Arr}^{TSa}{}_{T_{l_s,i}^h} - t_{Scheduled.Arr}^{TSa}{}_{T_{l_s,j}^r} \right| \quad (10.7)$$

4. The use of the same platform track at the LtfTS for the train pair according to their PVSCS is verified.
5. The existence of conflicting entrance routes for the train pair from the incoming link through the switching zone to their respective platform track is verified. For this, the matrix of reachability (Matrix E), the matrix of conflicts (Matrix K) and the matrix of occupancies (Matrix Z) attributed to the LtfTS, is utilized (see subsections 2.2.2 and 5.1).
6. The train pair is ranked and included in the ranking list $L_{CW_{l_s,o}}$. The train pairs are ranked according to the difference in their scheduled arrival time $a_{T_{l_s,i}^h - T_{l_s,j}^r}$ at the LtfTS, starting with the lowest values.
 - If the values rounded to the minute are equal between train pairs, the existence of a conflicting platform track is the deciding parameter, ranking first the train pair with a conflicting platform track.
 - If none of the train pairs has a conflicting platform track, the existence of a conflicting entrance route to the LtfTS is the deciding parameter. Thus, the train pair with conflicting incoming routes is ranked first.
 - If, until this point, there is no clear tiebreaker for two train pairs, the order in the initial entrance sequence is the deciding parameter. Thus, the train pair that contains the earliest train according to its position in the initial (FCFS) entrance sequence is ranked at the top. This last would ensure that trains closer to the LtfTS are systematically handled first.
7. Circle back to step number 2 until all elements in the set are included in the list $L_{CW_{l_s,o}}$.

10.5.4. Selecting a Pair of Trains from the List

The selection of a pair of trains from the ranked list of swaps $L_{CW_{l_s,o}}$ is a particularly important task to support the effective exploration of the search space by the Tabu Search algorithm. While the list provides with an overview of all possible swaps as it ranks them by their spatiotemporal relevance, the selection of elements in the list can be achieved through different approaches. This subsection provides a detailed discussion on the process of selecting a pair of trains from the list $L_{CW_{l_s,o}}$ in order to generate new entrance sequences u .

At the outset, once the train pair has been selected, as detailed in figure 10.5, their position in the last assessed sequence is swapped, and the resulting sequence is verified to see if it fulfills the sequence constraint on every incoming link. Before the resulting sequence is fixed by the CDCR process, its existence in the long-term Tabu list is verified. The resulting entrance sequence of queuing trains to the LtfTS must be respected during the CDCR process. An example of the selection of the swap and the resulting sequence is depicted in figure 10.7.

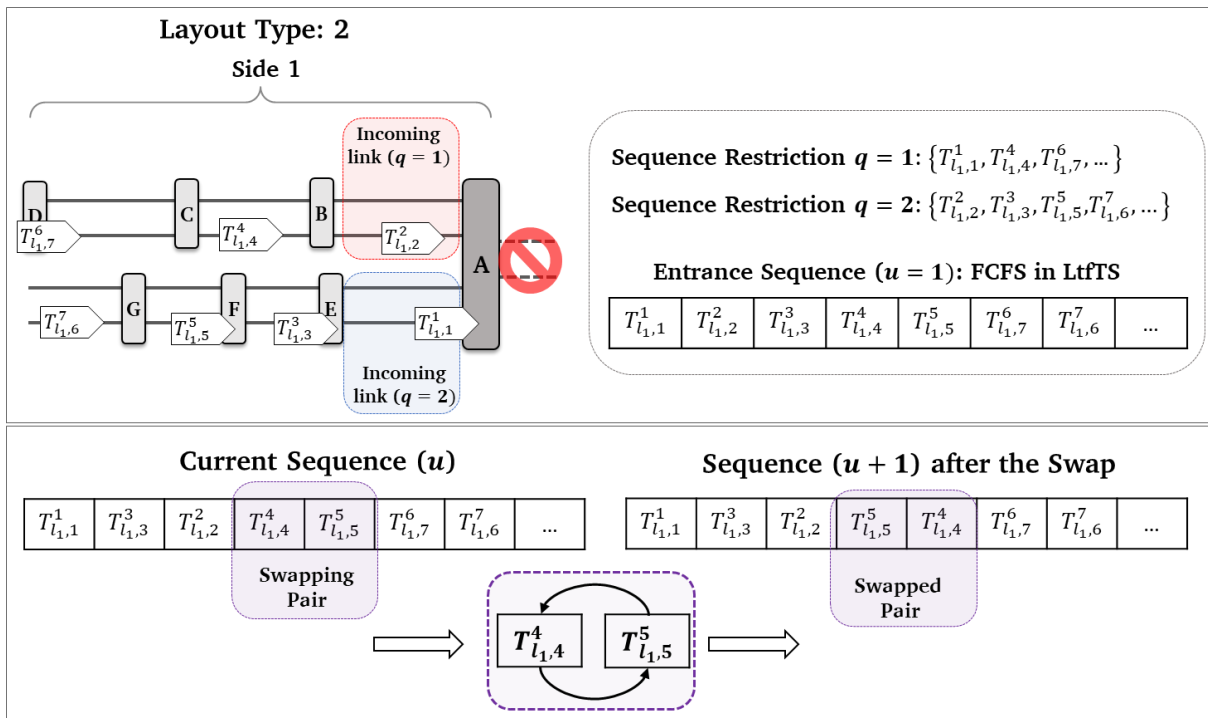

Figure 10.7 Example of the swapping of train pairs in the current sequence for the establishment of a new entrance sequence of potentially queuing trains to the LtFTS (by author)

The approach most often utilized in Tabu Search algorithms to select the next movement is conducted by randomly sampling a subset of only the elite movements from the list of available movements. Later, a subset of regular movements can be randomly selected to finalize the iteration (Glover et al. 1993). Another potential approach would be sampling the elements utilizing a probability distribution function. Furthermore, it is also possible to conduct the selection process by a systematic selection of the elements starting from the top of the list regardless of the iteration. This approach increases the computational time as it would oblige the search to explore less attractive movements. Finally, a random selection of movements may also be considered as an approach.

First, the characteristic approach of the Tabu Search necessitates, among other things, to determine the size of its subsets containing its elite and regular movements. The criterion to establish which elements are considered elite must also be defined before a sample of various elite elements from the ranked list can be extracted.

Second, the establishment of such a criterion, as the one discussed for the characteristic approach of the Tabu Search, is not required if the selection of the elements is conducted by sampling the entire list with a probability distribution function. However, in this last case, it becomes necessary to choose a function that better fits the purpose of selecting the pair of trains within the ranked list and establish the chosen function's respective parameters.

Third, a random selection of movements would be closely related to the one utilized in Simulated Annealing. However, this latter approach would defeat the purpose of ranking the list of best possible moves in the first place.

Consequently, from the three considered approaches, the most feasible approaches to conduct the selection of the elements in the list are: the characteristic approach utilized in the Tabu Search

and the sampling of elements utilizing a probability distribution function. However, some obstacles need to be dealt with for the implementation of each of the approaches.

Although both the characteristic approach used in the Tabu Search and the use of a probability distribution function may allow for a very effective selection process of the elements in the classified list, the accuracy with which a best fitting probability distribution function may be derived is challenging at this point. By selecting the characteristic approach, the need to derive and later calibrate the parameters of a probability distribution function within practical instances can be offset. Therefore, relying on the characteristic approach, the selection of the elements in the ranked list $L_{CW_{IS,o}}$ is advanced by distinguishing between elite and non-elite candidate swaps in every iteration.

Before detailing the selection process of elements in the ranked list based on the characteristic approach used in the Tabu Search, it is necessary to address two specific matters:

- i) A threshold between elite and non-elite swaps in the ranked list $L_{CW_{IS,o}}$ must be established.
- ii) The short-term candidate list must be partitioned in order to accommodate the randomly selected elements of elite and non-elite swaps.

As explained by Glover et al. (1993, p. 19), the establishment of an elite list of candidate moves is built on the assumption that “[...] a good move, if not performed at the present iteration, will still be a good move for some number of iterations. [...] The assumption is that a useful proportion of these transformed moves will inherit attractive properties from their antecedents.”. Additionally, Glover (1995, p.14) highlight that: “Because of the importance TS [Tabu Search] attaches to selecting elements judiciously, efficient rules for generating and evaluating good candidates are critical to the search process.”. Thus, in the case of swapping train pairs, swaps that are ranked on the top of the list are assumed to continuously constitute better alternatives and may be considered elite. This is due to the fact that the higher the difference in the scheduled arrival time $a_{T_{IS,i}^h - T_{IS,j}^r}$, the higher the chance that a swap would result in one of the trains in the swapped pair to wait until the preceding train in the sequence enters the station (see subsection 10.5.3).

To establish a threshold between elite and non-elite swaps, it is necessary to consider the approach for the establishment of the ranked list as detailed in subsection 10.5.3. Overall, the ranked list has been generated by comparing spatiotemporal aspects in the PVSCS of every train pair at the LtFTS. Consequently, a similar approach can be utilized to establish the threshold between elite and non-elite candidate swaps.

One possible approach can focus on the temporal aspect and establish the threshold between elite and non-elite swaps based on the difference between the scheduled arrival of the train pairs ranked on the list. A much more refined approach can establish the threshold not only considering temporal but also spatial aspects of every train pairs’ PVSCS at the LtFTS. While the consideration of both spatial and temporal features would allow refining the establishment of a threshold to distinguish the elite candidate swaps, the primordial features leading the ranking of the list is the difference in the scheduled arrival at the LtFTS of the train pairs.

As a result, the threshold in the ranked list may be established by considering a value that minimizes the potential of generating delayed trains due to the imposition of the entrance sequence constraints in the CDCR process. For this once again the on-time threshold t_{ot} can

become a useful benchmark. While the actual delay of the train during the CDCR process depends on multiple other variables this approach considers that an additional t_{ot} is permissible within the disrupted situation. Therefore, the threshold between elite and non-elite candidate swaps may be located at the last element in the ranked list $L_{CW_{IS,o}}$ that abides with equation 10.8.

$$a_{T_{IS,i}^h - T_{IS,j}^r} \leq t_{ot} \quad (10.8)$$

To establish the total number of elite and non-elite candidate swaps that are randomly selected from the ranked list, the short-term list must be partitioned in two. The partitioning of the short-term list must ensure it can hold a subset for elite candidate swaps and another for non-elite candidate swaps. The size of these subsets must be established by taking into consideration that the algorithm must try to handle the exploration as efficiently as possible while securing that it doesn't get stuck in local optimum. Additionally, bearing in mind the above-described partitioning of the ranked list, it must also be considered that the partition corresponding to the elite candidate swaps in the short-term list would have a significant influence on the results.

Therefore, to support the importance of the computational effort (see subsection 3.3.2), at least half of the train swaps being selected should have an improved likelihood of positively influence the fitness of the combination. By dividing the short-term list equally, the swaps which are in the absolute top of the ranked list would be prioritized without disregarding the potential benefit of the rest. Consequently, as a standard approach for the dynamic DRP deployment system, the size of the short-term list $L_{P_{IS,o}}$ for elite candidate swaps should secure that at least half of the movements that are selected are elite candidate swaps. An example of the size of the elite candidate subset is generalized in equation 10.9, modifying equation 10.6.

$$L_{P_{IS,o}}^{Elite} \cong \begin{cases} \left\lceil \frac{H}{8} \right\rceil \sim \left\lceil \frac{H}{10} \right\rceil, & \text{if } H \geq 30 \\ 4 \sim 3, & \text{if } H < 30 \end{cases} \quad (10.9)$$

The above-proposed standard approach is based on the assumption that half of the movements within one iteration should be selected for train swaps that have a difference in their scheduled arrival time $a_{T_{IS,i}^h - T_{IS,j}^r}$ to the LtFTS under or equal to the t_{ot} . This assumption should be verified through an implementation of the algorithm within an actual disrupted situation and contrasted against different sizes of the elite candidate subset in the short-term list $L_{P_{IS,o}}^{Elite}$. Additionally, depending on the computational effort, the limitations introduced in the above-proposed standard approach can be relaxed to widen the search.

Regardless of the size of the elite candidate subset in the short-term list, the size of the non-elite swaps can be established as detailed in the following equation 10.10.

$$L_{P_{IS,o}}^{N-Elite} = L_{P_{IS,o}} - L_{P_{IS,o}}^{Elite} \quad (10.10)$$

By incorporating the above-described selection process, which is based on the partitioned short-term list that distinguishes between elite $L_{P_{IS,o}}^{Elite}$ and non-elite $L_{P_{IS,o}}^{N-Elite}$ candidate swaps, figure 10.5 ought to be modified as depicted in figure 10.8.

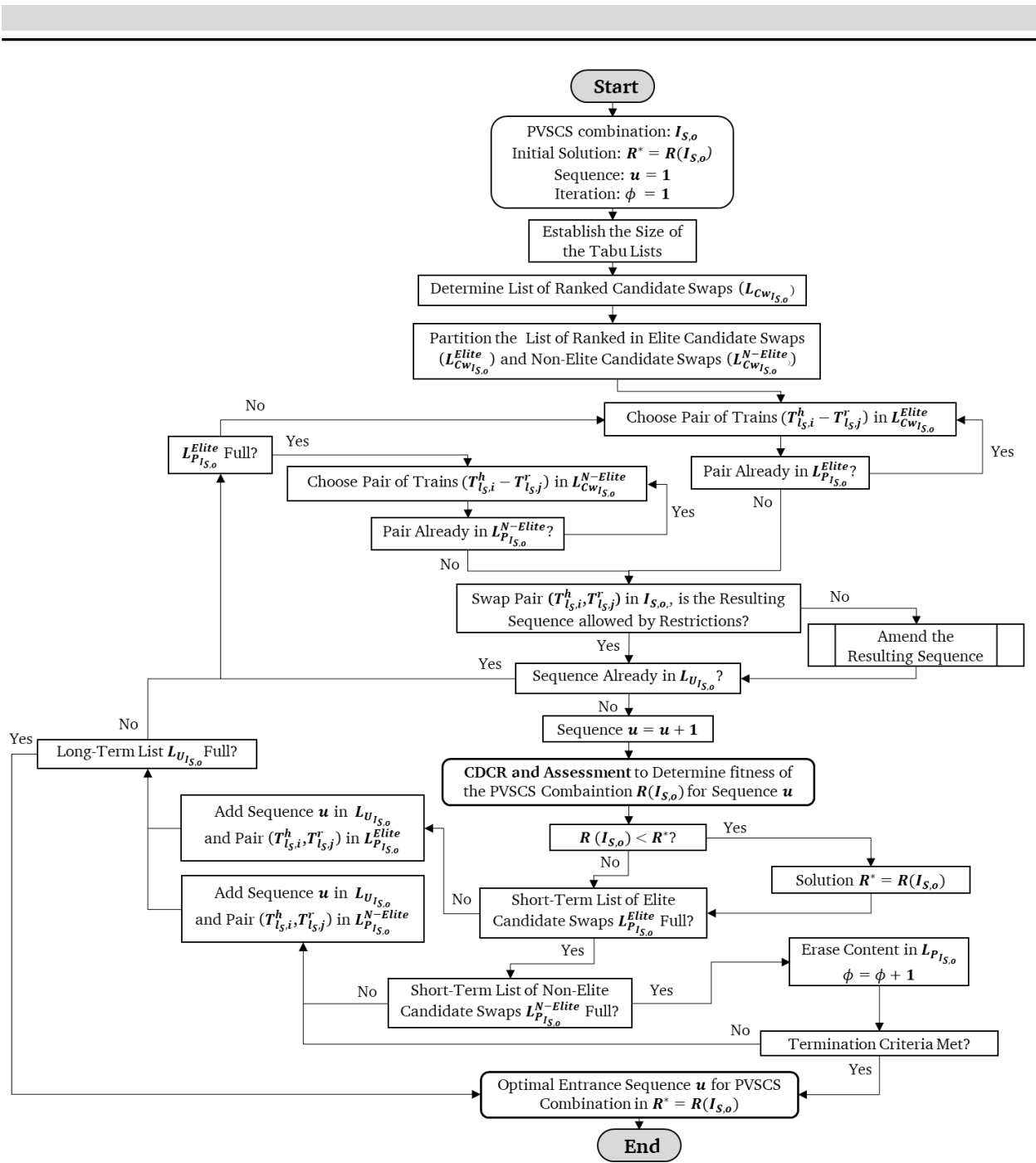

Figure 10.8 Structure of a Tabu Search Algorithm based on a selection of elite and non-elite moves for the establishment of the best entrance sequence of potentially queuing trains to the LtFTS (by author)

Ultimately, the selection of the trains from the $L_{CwI_{S,o}}$ in every iteration is conducted by constantly controlling that there is room available in the subset of elite candidate swaps $L_{P_{I_{S,o}}}^{Elite}$ as part of the short-term list $L_{P_{I_{S,o}}}$. If there is still room available, the pair of trains is randomly chosen from the top of the partitioned ranked list $L_{CwI_{S,o}}$ within the threshold of elite candidate swaps. If there is no more room in the subset $L_{P_{I_{S,o}}}^{Elite}$, the elements beyond the threshold can start being randomly selected and accommodated in the partition $L_{P_{I_{S,o}}}^{N-Elite}$ of the $L_{P_{I_{S,o}}}$.

10.5.5. Termination Criteria

As discussed in subsection 3.5.1, metaheuristic approaches mostly rely on some termination criteria to establish when they have found a solution that falls within the threshold that allows them to assume they have fulfilled their requirements. The termination criterion within a Tabu Search algorithm can be established in several ways.

One possible approach can be to parameterize the best termination criterion and identify one that better satisfies the available computing power. While this can benefit the computation time, it would have a negative effect on the quality of the solutions (Stelzer 2016). Therefore, the termination criteria can be better established by focusing on the execution process of the metaheuristic algorithm.

There are five termination criteria, which are most commonly utilized during the development of Tabu Search algorithms (Glover et al. 1993):

- a limited number of iterations,
- a limited number of iterations without any improvement in the incumbent solution,
- a fixed amount of computational time,
- performing a complete analysis of the search space, and
- terminate once an optimal solution that falls within a threshold value is found.

The movements of the Tabu Search entail the swapping of train pairs to explore the best possible entrance sequence of queuing trains to the LtFTS. Therefore, by favouring swaps that have a higher likelihood to derive sequences with better fitness as established by the evaluation function (see subsection 10.5.4), the fitness of the solution would increase considerably in early iterations. Moreover, the existence of the long-term Tabu list that avoids the algorithm to waste computing effort in revisiting the same solution twice would improve its ability to move around the search space. Therefore, aligned with the general requirements and limitations of the dynamic DRP deployment system (see subsection 3.4.2 and 3.3.2), limiting the number of iterations without improvements may be the best possible approach.

By limiting the number of iterations without improvements, the algorithm would attain a train sequence that already provides an improved handling of the potentially queuing trains in front of the LtFTS before it is terminated. While the solution could still be enhanced, there is a substantial likelihood that the additional effort being invested in this direction may not deliver any further practical relevance. This is the case since detailed and complex solutions may only be marginally applicable during real-time operations.

This criterion has also been utilized during the examination of the benchmark scenario established by Fan et al. 2012. The authors use an interval of five iterations without betterment to decide if to terminate their Tabu Search algorithm. However, despite that benchmark scenario assessed by Fan et al. (2012) is closely related to the Tabu Search detailed in this subsection, it addresses a much simpler problem. Furthermore, the Tabu Search explained within this subsection must function within a Genetic algorithm. Therefore, the interval between iterations is relaxed from the five utilized by Fan et al. (2012) to three iterations. Consequently, if there is no betterment in the incumbent solution after three iterations, the Tabu Search is terminated, and a sufficiently optimum entrance sequence for the PVSCS combination has been found.

10.6. Combination of the PVSCS – Genetic Algorithm

The Genetic algorithm is the principal metaheuristic in the structured approach for the combination of PVSCS. As it has been discussed in subsections 10.2 and 10.3, the wide extent of the dispatching possibilities covered within each of the train's PVSCS sets turns the process of assembling the PVSCS combinations into an extensive combinatorial problem. The Genetic algorithm is in charge of assembling the PVSCS combinations while steering the process towards the identification of a conflict-free schedule that better fits the objective function described in section 12. This subsection discusses and derives the structure of a Genetic algorithm, including a detailed discussion regarding the assembly of the PVSCS combinations within the dynamic DRP deployment system.

The Genetic algorithm to be established within this subsection has as its main objectives the assembly and management of multiple PVSCS combinations, thus, instituting multiple conflict free-schedules at once. As detailed by this module's structured approach, the Genetic algorithm is coupled with the Tabu Search and the fixing as well as the assessment processes, as depicted in figure 10.4 (see subsection 10.3). As a result, the Genetic algorithm constitutes the core process in the whole module, tying together the assembly of the PVSCS combinations, the exploration of the possible entrance sequences of the queuing trains to the LtFTS (if needed) and the fixing as well as the assessment of each of the assembled combinations.

To derive the structure of the Genetic algorithm to be established in this subsection, an overview of a Genetic algorithm's basic components is displayed in figure 10.9.

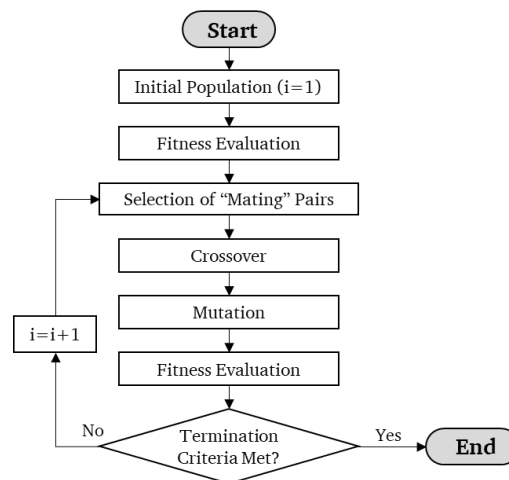

Figure 10.9 Flowchart diagram of a basic genetic algorithm (Yaacoub et al. 2009, modified by author)

First, an initial population of F elements is established. In case of the problem handled in this subsection, the initial population would entail an initial set δ of PVSCS combinations $I_{S,o}$ that must be generated. The PVSCS combinations in the initial population set constitute the algorithm's first generation (i.e. $\delta_{v=1}$) with a total number of F elements. Second, the fitness of every element in the initial population (i.e. PVSCS combinations $I_{S,o}$) must be determined. Third, elements in the initial population (i.e. PVSCS combinations $I_{S,o}$) must be selected and paired together to establish the "mating" pairs. In case of the problem handled in this subsection, a "mating" pair refers to a pair of PVSCS combinations that must exchange their attributes (i.e. PVSCS of specific trains) so that new PVSCS combinations may be generated. There are multiple approaches that can be utilized to establish the "mating" pairs (e.g. Tournament Selection - see Bickel and Thiele 1995). Fourth, a crossover operation must be performed. The crossover operation consists of the merger

of the attributes (i.e. PVSCS of specific trains) contained by the elements in a “mating” pair to generate new elements (i.e. PVSCS combinations) better known as the offspring. Fifth, certain attributes within the offspring must be randomly exchanged in a process referred to as “mutation”. The mutation entails a random alteration (with a very low likelihood) of the attributes of the newly generated elements product of the crossover (i.e. new PVSCS combinations), which allows the algorithm to avoid getting stuck in local optima. Sixth, the fitness of the elements in the new population must be established and a new generation (i.e. δ_{v+1}) is formed.

By aligning the basic components of a basic Genetic algorithm presented in figure 10.9 with this module’s structured approach detailed in subsection 10.3.2, the Genetic algorithm for assembling and managing multiple PVSCS combinations is derived. The resulting overall structure of the Genetic algorithm is depicted by the logical structure presented in figure 10.10.

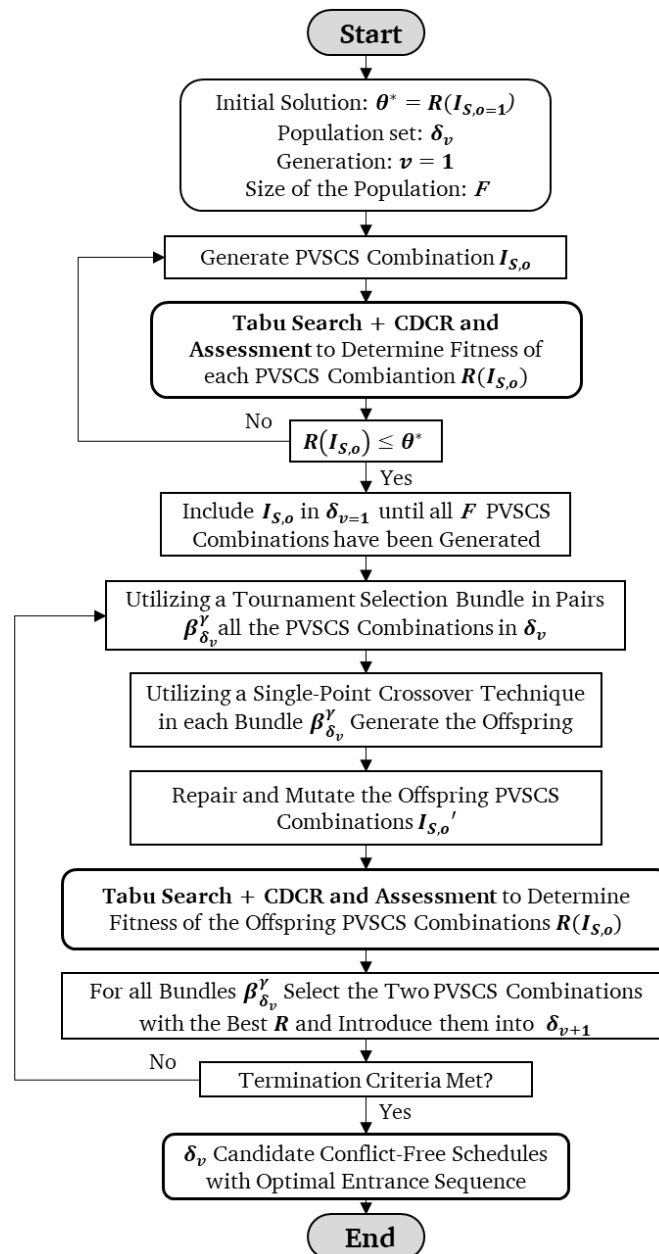

Figure 10.10 Structure of a Genetic algorithm for the development and handling of PVSCS combinations towards the establishment of the strived conflict-free schedules (by author)

The assembly and management processes of PVSCS combinations steered by the Genetic algorithm is summarized in the eight steps detailed below.

1. The fitness of the initial PVSCS combination R is introduced in the algorithm, which has been already ascertained by means of the Tabu Search algorithm $I_{S,o=1}$ or obtained by immediately fixing (i.e. making it conflict-free) and assessing the PVSCS combination $I_{S,o=1}$, as detailed in sections 11 and 12. The fitness of the initial combination constitutes the upper bound θ^* for the establishment of a set of PVSCS combinations as the algorithm's initial population $\delta_{v=1}$.
2. F PVSCS combinations $I_{S,o}$ to be included in the set of the algorithm's initial population $\delta_{v=1}$ are generated. Each PVSCS combination is generated, and their fitness R ascertained either through the Tabu Search algorithm (if needed) or obtained immediately by fixing and assessing the PVSCS combination as detailed in sections 11 and 12. Ultimately, a PVSCS combination $I_{S,o}$ can only be included in the set $\delta_{v=1}$ if its fitness does not exceed that of the upper bound θ^* .
3. The PVSCS combinations in δ_v are bundled in pairs $\beta_{\delta_v}^Y$ utilizing a tournament selection approach.
4. In every bundle $\beta_{\delta_v}^Y$, the paired PVSCS combinations produce two offspring utilizing a single-point crossover technique. The offspring constitute the new PVSCS combinations $I_{S,o}'$.
5. The resulting offspring or new PVSCS combinations $I_{S,o}'$ are verified to ensure they are operationally compatible. The PVSCS combinations that are operationally incompatible must be repaired (see subsection 10.4.1). The combinations are repaired by exchanging and mutating some of the train's PVSCS.
6. Once the resulting offspring prove to be operationally compatible, their fitness is ascertained. The fitness R of each offspring PVSCS combination is ascertained either through the Tabu Search algorithm (if needed) or obtained immediately by fixing and assessing the PVSCS combination as detailed in sections 11 and 12.
7. Within each bundle of now four resulting PVSCS combinations (i.e. mating pairs plus operationally compatible offspring), the two PVSCS combinations with the best fitness are selected to establish the next generation (i.e. δ_{v+1}). The two remaining PVSCS combinations are discarded. Like this, the new generation δ_{v+1} would have the same number of elements as the previous generation.
8. As established in the module's structured approach (see figure 10.4, also figure 10.9) if the termination criteria are satisfied, the conflicts-free schedules within the current δ_v contain the system's candidate solution for the accomplishment of its specific objective. If not, then the algorithm circles back to step 3.

From the eight steps that constitute the Genetic algorithm, four require further detailed so as to provide a more comprehensive overview of the management and assembly of the PVSCS combinations $I_{S,o}$. The following subsection 10.6.1, provides an overview of the generation of the initial population (step 2). Subsequently, the selection process of the members in population to assemble the new PVSCS combinations (i.e. offspring) (step 3) is further detailed in subsection 10.6.2. Thereafter, the two distinctive processes of Genetic Algorithms, namely, the crossover and mutation (steps 4 and 5), are derived in subsection 10.6.3. Finally, the termination criteria utilized to steer the exploration of the Genetic Algorithm and thus, the overall module of PVSCS combination is derived in subsection 10.6.4.

10.6.1. Generating the Initial Population

The establishment of an initial population (i.e. F PVSCS combinations $I_{S,o}$) is the first step in the Genetic algorithm. This subsection discusses the process of assembling multiple PVSCS combinations to constitute the initial population of the Genetic algorithm.

As discussed in subsection 10.4, the process for establishing a PVSCS combination can be complex and it requires to take into consideration aspects like: which of the trains would have a PVSCS from its PVSCS set selected first, and guaranteeing that all individual train PVSCS that constitute the PVSCS combination have operational compatibility (see subsection 10.4.1). Furthermore, aspects that are intrinsic to the algorithm must also be taken into consideration, namely, the number of F PVSCS combinations that need to be generated so as to constitute the initial population. As a result, the most important aspects to take into consideration for the generation of the initial population are:

- the approach utilized to assemble its elements (i.e. PVSCS combinations)
- and the size of the population F .

The approach most often utilized to generate the elements (i.e. PVSCS combinations) in the initial population is through a random selection.

In order to allow a representative sample across all handling options contained in the PVSCS sets of the trains across the network (i.e. the search space) to be extracted, the initial PVSCS combinations can be assembled through a random selection of PVSCS from every train's PVSCS set. Furthermore, so as to avoid assembling PVSCS combinations that would postpone the convergence of the Genetic algorithm, the assembly can be limited by introducing an upper bound.

Regarding the size of the initial population F , the larger the population, the wider the search space that can be explored. However, the time required for the algorithm to converge is significantly increased with the size of the population. It is recommended that for larger and complex problems, the population should be at least the same size as the number of elements in the string (i.e. PVSCS of specific trains) of every member of the population (i.e. PVSCS combination). However, experiments on the convergence of Genetic algorithms indicate an adept exploration size can be ascertained by a size equal to two times the number of elements in the string (Thierens and Goldberg 1994).

In the case of a PVSCS combination, the number of elements in its string is equal to the number of individual PVSCS that are necessary so that the PVSCS combination is successfully assembled. As discussed in subsection 10.4.2, a PVSCS combination has been successfully assembled when one PVSCS for every train has been introduced in the PVSCS combination $I_{S,o}$ while taking under consideration the existence of different sides S due to a complete blockage. Therefore, in each PVSCS combination, the number of elements in the string is equal to the total number of trains τ , per side (if applicable). Therefore, the number of PVSCS combinations F in the initial population can be ascertained by equation 10.11.

$$F = 2 * \tau \quad (10.11)$$

Having established the number of PVSCS combinations that need to be generated, the assembly process can now take place. At the outset, the generation of the initial population must be conducted within the boundary conditions of the problem being addressed. Therefore, a brief overview of the constraints that frame the PVSCS combinations would allow appreciating the

constraints that are required for their assembly. However, this process has already been completed during the establishment of the initial PVSCS combination (see subsection 10.4.1). Therefore, every assembled PVSCS combination must contain all trains with an investigation order (per side if applicable) and prove to be operationally compatible with each other.

Furthermore, the process utilized to generate the initial PVSCS combination can also be utilized to generate the initial population of the Genetic algorithm. Thus, the guided PVSCS selection process detailed in subsection 10.4.2 can be retrofitted with minor effort to conduct the assembly of PVSCS combinations for the initial population.

In the existing process, the selection of PVSCS from the PVSCS sets of every train utilizes the arrangement of the PVSCS set. This entails a systematic selection of PVSCS from the set and a simultaneous verification of their operational compatibility with PVSCS already contained in the PVSCS combination (see subsection 10.4.2). To generate the PVSCS combinations $I_{S,o}$ in the initial population, maintaining the guided selection of the PVSCS following their arrangement within the respective PVSCS sets $D_{T_{l_S,i}} \{d_{T_{l_S,i}'}, \dots, z_{T_{l_S,i}}\}$ is not compatible with the random selection that has been previously discussed. Therefore, in an effort to support the random selection of PVSCS, the guided selection in the existing process must be modified. On the other hand, regardless of the approach utilized to select the PVSCS from the PVSCS sets, the resulting combination still needs to guarantee that the PVSCS are operationally compatible with each other and that the resulting PVSCS combination considers all trains with an investigation order (i.e. complete) per side (if applicable).

As a result, a random selection process of the PVSCS in each of the PVSCS sets is put forward to assemble the PVSCS combinations for the algorithm's initial population. The random selection process refers to a random selection of the PVSCS $d_{T_{l_S,i}}$ in the PVSCS sets $D_{T_{l_S,i}} \{d_{T_{l_S,i}'}, \dots, z_{T_{l_S,i}}\}$ of every train. The random selection is complemented by a verification that makes sure that the selected PVSCS is compatible with the PVSCS of other trains already in the combination.

To conclude the generation of the PVSCS combinations, once these are generated within the constraints discussed above, the resulting combinations must have their fitness established. As detailed in the structured approach, the fitness of the PVSCS combinations is contingent on the infrastructure layout around the LfTS and is ascertained either through the Tabu Search algorithm or immediately as detailed in sections 11 and 12. Ascertaining the fitness allows making sure that the assembled PVSCS combinations abide with the upper bound established by the initial PVSCS combination, as discussed above.

In overall, the four-step PVSCS selection process introduced in subsection 10.4.2 is modified to support a random assembly of the PVSCS combinations for the initial population set $\delta_{v=1}$. The generation of F PVSCS combinations to be included in $\delta_{v=1}$ is conducted by means of the six steps detailed below.

1. Create a new PVSCS combination $I_{S,o+1}$, starting with ($o = 1$) since there already exists an initial combination.
2. Select a random set of sets $D_{l_S} \{D_{T_{l_S,i}'}, \dots, D_{T_{l_S,n}}\}_{l_S}$ that contains the PVSCS sets for all trains for an affected line from the superset $D \{D_{l_S}, \dots\}$.

- If there are no more sets in D , the PVSCS combination $I_{S,o} \{g_{T_{l_S,i}}, \dots, y_{T_{l_S,i}}\}$ is complete, and step 6 must be conducted.
3. Select a random PVSCS set that contains all the verified PVSCS for a train $D_{T_{l_S,i}} \{d_{T_{l_S,i}}, \dots, z_{T_{l_S,i}}\}$ from the current set of sets $D_{l_S} \{D_{T_{l_S,i}}, \dots, D_{T_{l_S,n}}\}$.
 - If there are no more sets in D_{l_S} , the algorithm circles back to step 2.
 4. Select a random PVSCS $d_{T_{l_S,i}}$ from the set $D_{T_{l_S,i}} \{d_{T_{l_S,i}}, \dots, z_{T_{l_S,i}}\}$.
 5. The PVSCS is verified to check if it is operationally compatible with already existing PVSCS in the combination $I_{S,o} \{g_{T_{l_S,i}}, \dots, y_{T_{l_S,i}}\}$. The verification of the operational compatibility verifies if the selected PVSCS $d_{T_{l_S,i}}$ abides with the line-specific conflict list for its line and if there are any misalignments with the trains already included in the PVSCS combination (and if necessary with the PVSCS in the combination on the opposite side – see subsection 10.4.1).
 - If the PVSCS is operationally compatible with the existing PVSCS in the PVSCS combination (and if necessary with the PVSCS in the combination on the opposite side – see subsection 10.4.1), it is introduced in the PVSCS combination $I_{S,o} \{g_{T_{l_S,i}}, \dots, y_{T_{l_S,i}}\}$ and the process circles back to step 3.
 - If the PVSCS is not operationally compatible with existing PVSCS in the PVSCS combination $I_{S,o} \{g_{T_{l_S,i}}, \dots, y_{T_{l_S,i}}\}$, the algorithm circles back to step 4. This process is conducted until a fitting PVSCS $d_{T_{l_S,i}}$ is identified. Once a PVSCS is identified, the process circles back to step 3.
 - If all PVSCS in the set have been verified in the PVSCS set of the respective train, the search is expanded to include one random train from the same line in the PVSCS combination. The search of the PVSCS shifts the PVSCS of the prior train to another random but compatible PVSCS in its set and the process circles back to step 4.
 6. The complete PVSCS combination $I_{S,o}$ must be fixed, assessed and refined within the Tabu Search algorithm (if applicable) to establish its fitness R and compare it with the upper bound θ^* .
 - If the $R \leq \theta^*$, the combination can be introduced in the initial population set $\delta_{v=1}$ and step 7 must be conducted.
 - If the $R > \theta^*$, the combination is discarded and the algorithm circles back to step 1.
 7. The number of elements in $\delta_{v=1}$ is controlled to check if the targeted population limit has been reached.
 - If the members in $\delta_{v=1}$ are less than F , the algorithm circles back to step 1.
 - If the members in $\delta_{v=1}$ are equal to F , the initial population set is complete.

Every assembled PVSCS combination $I_{S,o} \{g_{T_{l_S,i}}, \dots, y_{T_{l_S,i}}\}$ represents a set of PVSCS $d_{T_{l_S,i}}$ with τ elements that must be ordered sequentially in correspondence their investigation order, as detailed in subsection 9.3. Furthermore, if the disruption or the DRP operating concepts forces to recognized more than one side, the assembly of the PVSCS combinations on each side must be conducted in parallel. In this way, the verification process can guarantee that the resulting PVSCS combinations are operationally compatible with each other.

10.6.2. Selection

This subsection discusses the selection process of PVSCS combinations in the current population to establish the so-called “mating” pairs. As discussed above, “mating” pairs refer to a pair of PVSCS combinations from the current population that exchange their attributes (i.e. PVSCS of specific trains) so that new PVSCS combinations can be generated.

There is a broad range of approaches that can be utilized for selecting the different PVSCS combinations from the set δ_v , in order to establish the so-called “mating” pairs. Possible options are Roulette Wheel Selection, Stochastic Universal Sampling, Tournament Selection, Rank Selection, etc. However, as discussed by Blickle and Thiele (1995), achieving a balance between exploring the search space (i.e. random selection of elements in the population) and exploiting the benefit from elements with superior fitness in the population (i.e. guided selection of elements in the population), is critical for structuring a Genetic algorithm. The authors highlight that a good selection process is the one that is able to adjust the likelihood in which elements (i.e. PVSCS combinations) in the population are paired together, also called “selection pressure” (Blickle and Thiele 1995). By adjusting the “selection pressure”, the Genetic algorithm can provide a much more effective exploration of the search space, as it is able to control the diversity of the solutions that are generated. From the different approaches discussed above two of them allow a straightforward adjustment of their “selection pressure”, namely, the tournament selection and the rank selection.

The tournament selection pairs the elements by taking a random sample of α elements from the population and selects the element with the best fitness and introduces it into a pair bundle. The process is conducted until all elements in the population are introduced in a pair bundle. The “selection pressure” (i.e. the degree in which the best solutions are favoured) is adjusted by modifying the number of α elements that are randomly selected over time. The number of elements can be increased to secure that the chosen elements have a better fitness every time it is conducted.

A ranked selection requires that all elements in the population are ranked according to their fitness. The elements are ranked, starting with the element with the worst fitness. A selection probability is assigned utilizing a distribution function. The “selection pressure” (i.e. the degree in which the best solutions are favoured) is adjusted by modifying the parameters in the distribution function over time.

Both the tournament and the ranked selection approaches may allow for a very effective selection of the elements in the population. However, considering the ranked selection approach, the accuracy with which a best fitting probability distribution function and the necessary modifications to adjust the “selection pressure” can be derived at this point in the development of the dynamic DRP deployment system (see subsection 3.3.2), is very challenging. By selecting the tournament selection, the need to derive and later calibrate the parameters of a probability distribution function within practical instances can be offset. Consequently, the standard approach to be utilized in the dynamic DRP deployment system for the selection of the elements in the initial population of the Genetic algorithm would be the tournament selection.

The tournament selection would randomly extract a random sample of α PVSCS combinations from the current population and introduce the one with the better fitness in a pair bundle β_{δ_v} . The process is conducted until all PVSCS combinations in the population are introduced in a pair bundle. As discussed above, the degree in which the best solutions are favoured can be easily adjusted by adjusting the number of elements that are selected as part of α .

The tournament selection process may increase the number of PVSCS combinations being randomly sampled α to adjust the “selection pressure” according to the current iteration of the algorithm. The selection can start with a low number of PVSCS combinations being sampled and then increase the number of elements. This would allow an ample exploration of the search space at the beginning and a gradual transition towards the exploitation of the PVSCS combinations with the better fitness. However, it is still necessary to establish the range of elements α being sampled in every iteration.

According to Bickel and Thiele (1995), nearly half of the PVSCS combinations would be lost for a tournament size beyond 5 elements due to the increased likelihood of the pairing of PVSCS combinations with limited fitness. This means that the information they contained, namely, individual train PVSCS, which would otherwise be utilized to generate new PVSCS combinations will also be lost. Such phenomenon would lead to an increase in the likelihood of getting stuck in local optimum solutions. Therefore, the tournament selection process would start by sampling only two PVSCS combinations (i.e. $\alpha = 2$) to build the respective pair bundles. Later, for every new iteration, the sampling size would be increased by one and not going further than five.

As a result, the selection process is conducted in four basic steps until all elements in δ_v are introduced in a pair bundle $\beta_{\delta_v}^\gamma$. The four steps of the tournament selection process are detailed below.

1. Create a pair bundle $\beta_{\delta_v}^\gamma$, starting with ($\gamma = 1$).
2. Randomly select α elements (i.e. PVSCS combination $I_{S,o} \{g_{T_{1S,i}}, \dots, y_{T_{1S,i}}\}$) from the current population δ_v .
 - If $\begin{cases} 1 \leq v \leq 4; \alpha = v + 1 \\ v > 4; \alpha = 5 \end{cases}$
3. Choose from α , the element with the lowest R and introduce it into $\beta_{\delta_v}^\gamma$.
4. Is the pair bundle $\beta_{\delta_v}^\gamma$ complete?
 - If yes, then create a bundle $\beta_{\delta_v}^{\gamma+1}$ and return to step 2.
 - If no, return to step 2.

10.6.3. Crossover and Mutation

The crossover is conducted for each pair bundle with the sole purpose of creating the new generation of elements (i.e. PVSCS combinations). It does so by interchanging the information between the elements in the pair bundles, thus, creating the offspring (i.e. new PVSCS combinations). Another particular element within Genetic algorithms is the mutation. The mutation process is conducted during the crossover on specific components of the offspring to secure that new information is included in the new elements (i.e. PVSCS combinations) and avoid getting stuck in local minima. The mutation is usually performed according to a general probability value, and if it is set to high, it will randomize the exploration of the search space.

As for the selection process, different approaches can be utilized to conduct the crossover. The most common are: Single-Point Crossover, Multi-Point Crossover, Uniform Crossover (Umbarkar and Sheth 2015). The crossover technique needs to reflect the constraints that outline the development of the new elements (i.e. PVSCS combinations). In this case, the constraints discussed in subsection 10.2, 10.4.1 and 10.6.2, also apply to the development of the PVSCS combinations that will constitute the algorithm’s new generation. Therefore, the crossover technique utilized to

generate the offspring in every bundle $\beta_{\delta_v}^Y$ must support the development of complete and operationally compatible PVSCS (see subsection 10.4.1 and 10.6.1).

Most crossover techniques exchange information between elements (i.e. PVSCS combinations) randomly. In the case of the handled problem, this would mean a random interchange of the PVSCS that constitute each of the “mating” pairs (i.e. PVSCS combinations). However, this will derive in the establishment of new PVSCS combinations that will most certainly be operationally incompatible. Therefore, the likelihood of generating incompatible PVSCS must be reduced and a repairing heuristic introduced to secure that the resulting PVSCS combinations abide by the constraints must be designed. Since the likelihood that the generated PVSCS combinations would need to be repaired due to a potential operational incompatibility would always be present (see subsection 10.4.1), the mutation process (see figure 10.9) can be included within the repairing heuristic as a last resort and practical tool to make the PVSCS combination operationally compatible.

From the existing approaches, the two most utilized and simple to implement are the single point and multipoint crossover techniques (Umbarkar and Sheth 2015). Both of the approaches are depicted in figure 10.11. The single point crossover, which is depicted in figure 10.11-A, randomly locates a point in the string of elements of each of the PVSCS combinations in the pair bundle. Later, the elements in the string to the right of the chosen point are exchanged between the elements. On the other hand, the two-point crossover, which is depicted in figure 10.11-B, randomly locates two different points in the string of elements and exchanges the elements between the two points from one element to another.

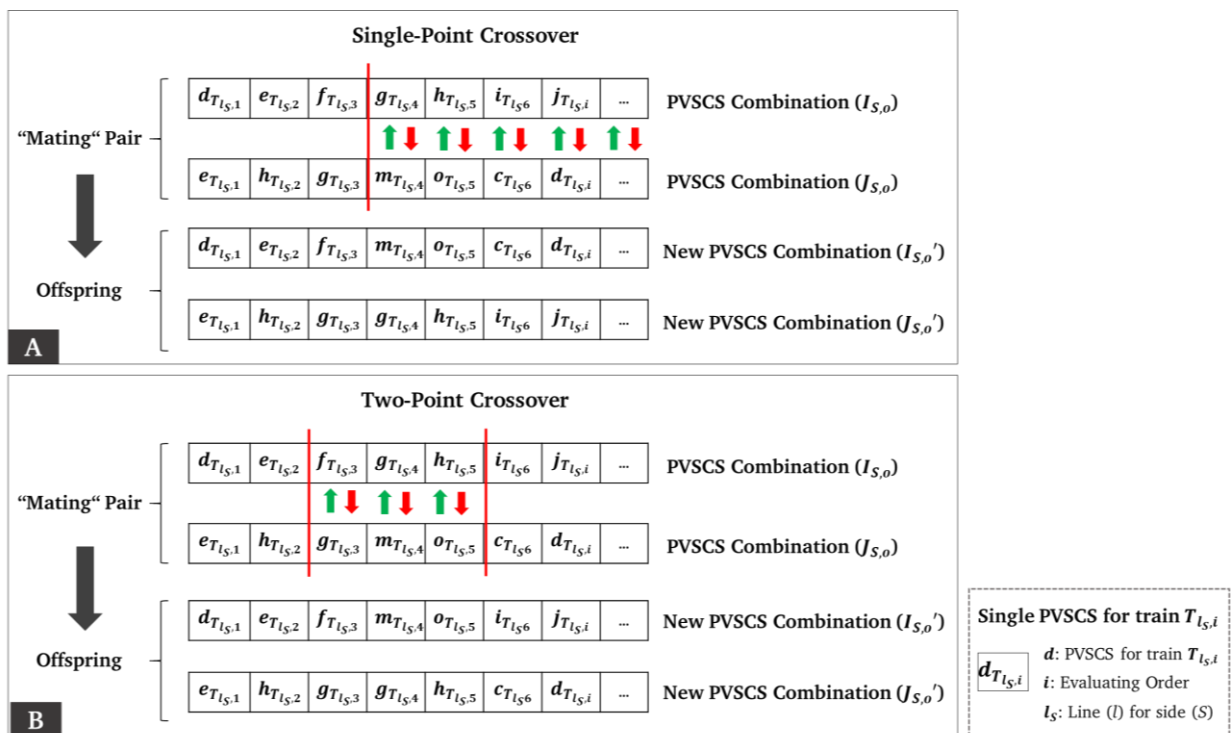

Figure 10.11 Single (A) and two-point (B) cross-over technique implemented on a pair of PVSCS combinations (by author)

To reduce the likelihood of generating unfeasible combinations as well as the complexity of the resulting PVSCS combinations that need to be repaired, the one-point crossover technique is

utilized. The technique will allow obtaining two new elements (i.e. offspring), each with only two sections of their string of elements that must be repaired.

The repairing process of the resulting offspring (i.e. new PVSCS combination) must make sure that all the PVSCS in the PVSCS combination are operationally compatible. However, the repairing process cannot be executed randomly, since this would defeat the purpose of the selection process discussed in subsection 10.6.2. Therefore, the conflicting PVSCS (i.e. exchanged PVSCS in the offspring that are operationally incompatible) in every new PVSCS combinations should be exchanged by trying to minimize the effects of randomizing the crossover process. As during the establishment of the initial PVSCS combination (see subsection 10.4), the solution for this problem may be found in the process with which every PVSCS of each train was developed and introduced into its PVSCS set (see section 9).

As discussed throughout subsection 9.5 and 9.8, the development of the PVSCS and their subsequent arrangement in the PVSCS set was conducted through an organized selection and combination of isolated elements in three different lists (i.e. line-specific conflict solution, accessible infrastructural elements and potential transition train services). During the establishment of the initial PVSCS combination (see subsection 10.4.1), the first possible element in the PVSCS set of every train was of significance. However, at this stage, an approach needs to be derived to decide which of the three elements that constitute the conflicting PVSCS would be worth maintaining so that the selection of another PVSCS from the PVSCS set is not random.

As discussed in subsection 3.5.2, one of the focus of the dynamic DRP deployment system as a decision-support tool is the exploration of the best possible dispatching measure to address the disrupted situation. Therefore, to repair the conflicting PVSCS, PVSCS in the respective train's PVSCS set that allow maintaining the line-specific conflict solution measure (see subsection 9.4.2) must be identified. Thus, for all conflicting PVSCS in the combination, possible PVSCS in their PVSCS set that utilize the same line-specific conflict solution and only exchange the services in their circulation plan or the accessible infrastructural elements can be explored first. The mutation (i.e. random selection of elements in the PVSCS sets) can be conducted if no operationally compatible PVSCS within the above-explained conditions is found.

The repairing approach derived in this subsection can be clarified by the following example. If the PVSCS of two different trains (from the same line) in the PVSCS combination resulting from the crossover have the same transition train service after their early turn (i.e. conflicting), the PVSCS of one of the trains needs to be repaired. Following the repairing approach, the PVSCS set of one of the trains would need to be explored for a different PVSCS that also foresees the early turn of the train, but this time towards a different train service. This would allow making one of the originally conflicting PVSCS to be operationally compatible with the rest of PVSCS in the new PVSCS combination. However, if no PVSCS that allows the train to maintain its early turn can be located, a random selection of PVSCS from the respective train's PVSCS set is conducted as part of the mutation processes.

The crossover, repair and mutation processes are conducted in eight steps for all elements in the pair bundles $\beta_{\delta_v}^Y$ within the current population set δ_v .

1. Select a pair bundle $\beta_{\delta_v}^Y$ from the population δ_v .
 - If there are no more pair bundles, the crossover, repair and mutation processes are complete.

2. Perform a single-point crossover on both of the PVSCS combinations $I_{S,o}$ in the bundle $\beta_{\delta_v}^Y$.
3. Derive the two new PVSCS combinations $I_{S,o}'$ which may still need to be repaired.
4. Select new PVSCS combination $I_{S,o}'$ from the bundle $\beta_{\delta_v}^Y$.
 - If there are no more PVSCS combinations that need to be repaired, the algorithm circles back to step 1.
5. Identify the PVSCS $d_{T_{I_{S,i}}}$ that are not operationally compatible with each other.
 - If there are no operationally incompatible PVSCS in the combination, then $I_{S,o}'$ turns into $I_{S,o+1}$ and the algorithm circles back to step 4.
 - If there are operationally incompatible PVSCS, they are isolated in a temporal subset $\varepsilon_{I_{S,o}'}$.
6. Randomly select one of the conflicting PVSCS $d_{T_{I_{S,i}}}$ from $\varepsilon_{I_{S,o}'}$.
 - If there are no more PVSCS in $\varepsilon_{I_{S,o}'}$ or $\varepsilon'_{I_{S,o}'}$, the algorithm circles back to step 4.
 - If there are no more PVSCS in $\varepsilon_{I_{S,o}'}$, but there is still PVSCS in $\varepsilon'_{I_{S,o}'}$, step 8 (i.e. mutation) must be performed.
7. Identify a PVSCS within the respective train's PVSCS set $D_{T_{I_{S,i}}}$ that maintains the dispatching measure but exchanges the infrastructural elements to make it compatible with the combination $I_{S,o}'$.
 - If a PVSCS has been successfully located, the elements in $\varepsilon_{I_{S,o}'}$ and $\varepsilon'_{I_{S,o}'}$ must be updated since it is possible that more than one element can be removed and the algorithm circles back to step 6.
 - If no PVSCS has been located, the search is expanded to include PVSCS that also exchanges the circulation plan.
 - If a PVSCS has been successfully located, the elements in $\varepsilon_{I_{S,o}'}$ and $\varepsilon'_{I_{S,o}'}$ must be updated since it is possible that more than one element can be removed and the algorithm circles back to step 6.
 - If no PVSCS has been located, the PVSCS is introduced in a set $\varepsilon'_{I_{S,o}'}$, and the algorithm circles back to step 6.
8. A random search in the PVSCS sets for all the remaining elements in $\varepsilon'_{I_{S,o}'}$ is conducted until a PVSCS compatible with $I_{S,o}'$ is found or all the PVSCS in the respective set $D_{T_{I_{S,i}}}$ have been explored. Once a fitting PVSCS is found the elements in $\varepsilon'_{I_{S,o}'}$ are updated.
 - If there are no more elements in $\varepsilon'_{I_{S,o}'}$, the algorithm circles back to step 4.
 - If there are still elements in $\varepsilon'_{I_{S,o}'}$, both combinations $I_{S,o}'$ are discarded, and the algorithm circles back to step 2.

10.6.4. Termination Criteria

Just as for the Tabu Search algorithm (see subsection 10.5.5), different termination criteria can be utilized to conclude the exploration of the Genetic algorithm. In Genetic algorithms, potential termination criteria are (Ghoreishi et al. 2017):

- a limited number of generations,
- a limited number of explored elements,
- a limited computational time,
- the element with the better fitness in the population has reached a predefined value,

-
- and the element with better fitness does not change for a predefined number of generations.

Due to its handling of a broad range of elements, the Genetic algorithms may include more than one stopping criterion. Considering that the Genetic algorithm is the leading exploring engine within the dynamic DRP deployment system, it is particularly important that it is aligned with the computational effort available (see subsection 3.4.2). Thus, above all else, the algorithm must secure an improved likelihood of acquiring solutions that guarantee that the fitness, as established by the evaluation function, improves with a limited computational effort.

To allow a better adjustment of the PVSCS combination assembly process to the available computational effort and avoid premature convergence, the Genetic algorithms utilize two different stopping criteria. The termination criteria being used are: imposing a limit on the number of the explored elements and stagnation in the improvement of the best solution. Together these termination criteria would impose a hard limit on the exploration (i.e. limit the number of explored elements) and a more situation oriented limit that would take into consideration the betterment in the solutions at every iteration.

Since the Genetic algorithm is the leading exploring engine of the whole system, the search must be terminated at some point. The first termination criterion is derived from existing research, which recommends that the total number of explored elements, should not exceed 2^τ , where τ is the number of trains in the combination (Bhandari et al. 2012). Therefore, if the total number of explored PVSCS combinations throughout all the generation exceeds 2^τ , the Genetic algorithm must be terminated.

The second criterion focuses on the stagnation of the best solution's fitness. This principle is similar to the one utilized in the Tabu Search algorithm. However, in this case, the algorithm does not stop until the fitness of the best solution in the current population remained the same after a predefined number of generations. This criterion can be easily adjusted in correspondence to the available computational effort, yet a standard criterion for the dynamic DRP deployment system must be established. To recommend a predefined number of generations, the number of combinations that constitute the population in each generation must be considered. The higher the number of combinations, the fewer the number of generations needed.

Bhandari et al. (2012), generalizes that the maximum number of generations without any betterment can be ascertained as a predefined percentage value (between 20% and 30%) of the generation number in which the best solution was established. Therefore, if the combination with the best fitness was found at the generation ($v = 100$) and it did not change after 30 generations (if 30% is implemented), the algorithm is terminated.

10.7. Closing Remarks

This section provided a detailed discussion regarding the derivation and functioning of the structured approach to assemble the PVSCS combinations utilizing the PVSCS sets for every train developed in section 9. Initially, the specific requirements and limitations for the development of the combinatorial engine as part of the dynamic DRP deployment system have been first discussed. This discussion allowed to identified three sub-problems that needed to be addressed by the structured approach in charge of the assembly of the PVSCS combinations. Further, existing approaches that would allow addressing each of the identified sub-problems have been discussed and adeptly selected. With an understanding of the complexity of the PVSCS combination problem

and a series of potential metaheuristic approaches that could be applied, the structured approach for the PVSCS combination process has been successfully established.

Overall, the proposed approach combines two metaheuristic algorithms, namely, a Genetic and a Tabu Search algorithm, supported by further heuristic principles (e.g. FCFS principles). The proposed approach seeks not only to generate the PVSCS combinations but also manage the exploration of further alternatives as established by the system's general approach. Furthermore, with its structure, the resulting module aligns the Genetic and Tabu Search algorithms with the vehicle-specific CDCR and the assessment modules (see figure 3.1 and sections 11 and 12), constituting the system's exploring engine in its path to deriving the strived conflict-free schedule.

The different processes that have been detailed are explicitly intended to tackle and adapt to the problem complexity — starting with the development of an initial solution that is anticipated to structure a standard solution for the whole disruption-management — followed by the Tabu Search algorithm, whose own structure has been devised to secure efficient and effective handling of the queuing trains enhancing each PVSCS combination that is assembled. Finally, the kernel that brings all together, the Genetic algorithm with its built ability to develop and repair new PVSCS combinations.

Each of the metaheuristic algorithms proposed throughout this section has been carefully structured to abide with the implementing filed of the system; however, specific parameters (e.g. size of the short-term Tabu list, the size of the initial population of the Genetic algorithm or the process supporting the selection of the elements in the population) would profit from being tested within actual circumstances. While the focus of this *Section* is the development of a system's logical structure, the testing within actual circumstances falls out of its scope (see section 3.3.2).

The close interplay between the two metaheuristic algorithms and the vehicle-specific CDCR process, as well as the assessment of the assembled combinations towards their path of becoming conflict-free schedules, has been highlighted throughout the whole section. The following section provides a close account of the handling of the vehicle-specific conflicts for every PVSCS combination assembled through an automatic CDCR process based on the utilization of predefined conflict solution alternatives (see subsection 6.5).

11. Vehicle-Specific Conflict Detection and Resolution (CDCR) Processes

11.1. Introduction

The automatic CDCR process provides the dynamic DRP deployment system with the capability to transform the PVSCS combinations into spatiotemporal conflict-free schedules. As discussed in section 9, the PVSCS for every train is a product of the line-specific conflict identification and establishment of potential conflict solutions derived in section 8. To reduce the complexity during their development, the PVSCS for every train in the network are developed by considering an empty network. The resulting PVSCS for every train are later selected from their respective PVSCS sets and assembled into a series of combinations, as discussed in section 10. This module has the objective to fix at a vehicle-specific level (i.e. solve every conflict, making the PVSCS combination conflict-free) each PVSCS combination that has been assembled in section 10. The fixing process is conducted through an automatic CDCR process that relies on predefined vehicle-specific elemental conflict solutions detailed in section 6 and supported by the assessment module in section 12.

This section describes the necessary processes for the development of conflict resolution alternatives that allow solving the vehicle-specific conflicts for every PVSCS combination assembled in section 10. The approaches are presented with respect to each of the vehicle-specific conflict types handled by the dynamic DRP deployment system, namely, occupancy, infrastructure availability, circulation, and service conflicts (see subsection 3.5.2).

This section first details in subsection 11.2, the specific requirements and limitations for advancing an automatic vehicle-specific CDCR process as foreseen by the dynamic DRP deployment system general method (see section 3.5.2). Thereafter, subsection 11.3 derives the structured approach for conducting an automatic vehicle-specific CDCR process to handle the assembled PVSCS combinations, which are attained either directly from the Genetic algorithm (i.e. infrastructure layout 1 – see figure 10.1) or the Tabu Search algorithm (i.e. infrastructure layout 2 – see figure 10.1). Subsection 11.4 details the portion respective to the conflict identification within the CDCR process derived in subsection 11.3. Subsequently, in subsection 11.5, the development of conflict resolution alternatives for every identified conflict is explained in detail. The development of conflict resolution alternatives relies on the predefined vehicle-specific elemental conflict solution bundles detailed in section 6. Every developed conflict resolution alternative is subsequently assessed, as advanced in section 12.

11.2. Requirements and Limitations for the CDCR Process

This subsection provides an overview of the requirements and limitations to advance the vehicle-specific CDCR process. The requirements described within this section are based on the requirements of the dynamic DRP deployment system (see subsection 3.4.2) and complemented by specific processes that have been advanced in previous modules. A complete overview of the constraints with which the automatic vehicle-specific CDCR process is to be advanced can be secured by considering the specific requirements as well as limitations detailed in subsections 3.4.2, 3.3.2, and the module's alignment with the rest of the dynamic DRP deployment system.

As discussed in subsection 2.2.3, CDCR processes entail four essential steps, namely, conflict identification or detection, conflict classification, sorting of conflicts in a list, and the development of conflict resolution alternatives. Each of these steps must be handled within this module.

Particular attention must be given to the conflict resolution since it requires a set of predefined solution alternatives (see subsection 3.4.2). These measures have already been detailed and clustered into bundles in subsection 6.5 and must be incorporated in this module's overall structure.

The CDCR process must devise specific structures to support the four essential steps across the vehicle-specific conflict types handled by the dynamic DRP deployment system, namely, occupancy, infrastructure availability, circulation and service conflicts (see subsections 3.4.2 and 3.5.2). The only exception being the sorting in the conflicts into one unique conflict list that must be conducted in parallel for all conflicts identified in the PVSCS combination, as detailed already for the line-specific conflicts (see subsection 8.5).

As an automatic process, the CDCR module must support the exploration of the broadest range possible of conflict solution alternatives (including their combination) while upholding the limited computational effort required for the system overall. Furthermore, the exploration of the resolution alternatives for each conflict in the list must not discriminate between trains (see subsection 3.4.2). Such requirement permits to recognize the need to support the synchronous listing and handling of train conflicts and the introduction of the necessary mechanisms to avoid generating potential deadlocks (see subsection 2.2.3).

Moreover, since the selection of the generated resolution alternatives is conducted within the assessment process detailed in section 12, this module must support a communication and direct interchange with the assessment module (see subsection 3.5.2 and 3.5.3). Furthermore, as discussed in subsection 3.5.2, the CDCR module must also support 'look-ahead' capabilities to facilitate the exhaustive assessment of the developed conflict resolution alternatives, which is, in principle, an identification of follow-up conflicts (see subsection 2.2.3).

To secure the alignment of the CDCR process as part of the dynamic DRP deployment system, the module must be able to handle the constraints introduced during the development of the PVSCS combinations (see section 10). Therefore, the Tabu Search algorithm and the constraints it imposes on the entrance sequence of all potentially queueing trains to the LtFTS must be carefully handled within the CDCR process (see subsection 10.5). Besides, it must also be highlighted the importance regarding the handling of trains in the vicinity of the disrupted section and especially within the critical area of the network (e.g. the last two technically feasible turning stations to support the transition of the system to stability - see subsections 2.3.2 and 3.7.2). Therefore, not only the constraints imposed upon the handling of potentially queueing trains must be supported by the CDCR process but also the effective identification and resolution of train conflicts within the critical area.

The CDCR process advanced within this module must also be compatible with the granularity in which the infrastructural elements are modelled. As discussed in subsection 2.2.2, the degree in which the infrastructural elements have been considered and the available attributes for each of the infrastructural elements will most certainly outline the quality of the identified solutions and the computational effort required to generate the resolution alternatives. In the case of the dynamic DRP deployment system, the structured CDCR process must be compatible with the enhanced macroscopic modelling of the infrastructure, as detailed within subsection 5.1.

Whereas the infrastructure modelling is a doormat influence in the computational effort and the quality of the derived solutions, the availability of information from different railway traffic types that circulate throughout the infrastructure is equally important (see section 5). The quality of the

required information so that the system is able to consider these trains has been discussed in subsection 5.4.2. As a result, the CDCR process advanced in this module ought to consider handling different railway traffic types, to the extent that the information is made available to the system.

In the following subsections, the existing approaches and the required adjustments that would allow structuring a CDCR process aligned with the requirements and limitations considered in this subsection are discussed.

11.3. Structured Approach for the CDCR Process

The requirements discussed in subsection 11.2 allow framing the overall approach for structuring a CDCR process able to handle the four vehicle-specific conflicts as part of the dynamic DRP deployment system. However, since most of these matters have been already addressed within the existing research, it is necessary to briefly review the available approaches.

Before the structured approach to conduct the CDCR process on any PVSCS combination is derived, this subsection first discusses existing approaches for each of the four CDCR steps discussed in subsection 2.2.3. Thus, an overview of the available approaches that support this module's requirements and limitations is briefly conducted in subsection 11.3.1. Later, subsection 11.3.2 discusses the establishment of a structured approach for advancing the automatic vehicle-specific CDCR process, relying on the approaches discussed in 11.3.1 as foundation.

11.3.1. Existing CDCR Approaches

This subsection provides an overview of existing approaches that may be utilized for the advancement of a CDCR process as detailed by the requirements and limitations discussed in subsection 11.2. It focuses on approaches discussed in subsection 2.2.3 that support a heuristic automatic CDCR process, utilize predefined elemental conflict solution alternatives and are adjustable or compatible within the infrastructure modelling technique utilized for the dynamic DRP deployment system. The consideration of the existing approaches includes the identification and the development of conflict resolution alternatives for each of the vehicle-specific conflict types addressed in the system. With regards to the identification of conflicts, existing approaches or models able to tackle the classification and the sorting of conflicts in a conflict list are also considered.

Among existing CDCR approaches, the core focus is on the handling of occupancy conflicts, which indirectly consider infrastructure availability conflicts. Some of the most adept approaches discussed in subsection 2.2.3, which allow supporting the handling of occupancy conflicts are presented by Chiang and Hau 1995, Chiang et al. 1998, Şahin 1999, Wegele and Schnieder 2005, Oetting et al. 2011, Oetting et al. 2013 and Neuber 2017.

From the above-highlighted approaches, the most closely related to the requirements and limitations to be supported by this module is the model proposed by Oetting et al. (2011). While it is used for planning purposes, its proposed heuristic CDCR approach is not only based on predefined elemental conflict solution alternatives but also over a similar infrastructure modelling technique as the one utilized in the dynamic DRP deployment system. As it has been discussed in subsection 2.2.3, this asynchronous approach supports the identification, classification, and resolution of occupancy and infrastructure availability conflicts. Of particular importance is the approach's classification of conflicts, which is based on the infrastructural elements in which they occur and the special handling of different conflict classes (including follow-up conflicts).

However, there are still significant modifications that need to be introduced, particularly regarding the capability to support a wider range of elemental conflict solution alternatives and the handling of conflicts within the critical area.

While other models are built over a microscopic handling of conflicts; for example, Oetting et al. (2013) or Şahin (1999)(see subsection 2.2.3), the degree of detail and exact approach utilized to address the occupancy conflicts limit their compatibility with the proposed dynamic DRP deployment system. However, the degree of detail offered by the above-named approaches would allow highlighting certain enhancement potentials to be introduced in the approach presented by Oetting et al. (2011). The remarks made by Oetting et al. (2013), concerning the management of the conflicting paths and follow-up conflicts are particularly relevant. Furthermore, Oetting et al. (2013) also highlight the need to include the establishment of the number and severity of all identified conflicts to support the development of a look-ahead capability in the system and lay the foundation for the subsequent evaluation of the developed conflict resolution alternatives. The understanding behind the severity of conflicts has also been discussed in subsection 3.6.2.

Models that handle circulation conflicts are also available. Existing approaches that would support handling the circulation conflicts as part of the system partially or totally have been discussed in subsection 2.2.3 (i.e. Nielsen 2011, Fekete et al. 2011).

For the handling and resolution of circulation conflicts, the existing structure, which is better aligned with the requirements and limitations discussed in subsection 11.2, is provided by the approach of Fekete et al. (2011). While the model is capable of handling circulation conflicts with adeptness, it relies on an exact approach to address the circulation problems, namely, exact methods directed by a fitness function. Therefore, the identification and solving of circulation conflicts should have an approach specially tailored for the dynamic DRP deployment system, just as the handling of service conflicts.

11.3.2. Structured CDCR Process

This subsection derives a structured approach to conduct a CDCR process at a vehicle-specific level, which is founded over the existing approaches discussed in subsection 11.3.1 and aligned with the requirements discussed in subsection 11.2.

As discussed in subsection 11.2, the structured approach supporting the vehicle-specific CDCR process must be able to conduct the: conflict identification, conflict classification, assortment in a conflict list, and development of conflict resolution alternatives. Moreover, the structured approach to be derived in this subsection bridges these four processes with the four vehicle-specific conflict types addressed as required for the dynamic DRP deployment system (see subsection 3.4.2). Additionally, the structured approach is also in need to support the identification and handling of follow-up conflicts, which would support an enhanced assessment of the conflict resolution alternatives being developed by the CDCR process, as discussed in subsection 2.2.3.

The structured approach starts with conflict identification and classification, where the approach introduced by Oetting et al. (2011) is utilized as the foundation of the overall structure. The existing approach should be merged with specially tailored processes in order to allow identifying conflicts that are not handled by the existing processes, namely, infrastructure availability, circulation and service conflicts (see subsection 11.3.1). Furthermore, as detailed in the requirements (see subsection 11.2), the central characteristic to be advanced in the conflict classification process is its ability to distinguish the temporal characteristic of the identified

conflicts. This would support the synchronous sorting of the identified conflicts in the conflict list, as foreseen in 11.2. However, spatial matters should also be recognized to sharpen the classification, particularly, to distinguish conflicts that take place in the critical area of the network. The critical area is of particular interest since it is the location where a potential queue of trains is most likely to form; thus, it is central for the transition of the network to stable operations (see subsections 2.3.2, 2.3.3 and 3.4.2).

For the development of conflict resolution alternatives, the overall structure is also founded over the approach introduced by Oetting et al. (2011) that focuses on the handling of occupancy conflicts. Thus, the approach needs to be retrofitted with the necessary processes to address specific requirements of the dynamic DRP deployment system and be capable of handling the four vehicle-specific conflict types. Furthermore, a connection with the predefined elemental conflicts solution alternatives detailed in subsection 6.5, should also be guaranteed. As discussed in subsection 3.5.2, the predefined elemental conflicts solution alternatives constitute the foundation for the development of different conflict resolution alternatives for each identified conflicts.

Additionally, as detailed by the system's general approach (see subsection 3.5.2), each of the developed conflict resolution alternatives is in need to be individually assessed through an evaluation function (see section 12). Since this process must be done systematically for every identified conflict in the investigated PVSCS combination, the structured approach must support a systematic communication between the CDCR process and the assessment module (see subsection 11.2). Through the development of the different conflict resolution alternatives, their assessment, and the selection of the best alternative, the strived conflict-free schedules (i.e. fixed) from every investigated PVSCS combination can be achieved (see section 10).

Ultimately, since the overall structure also seeks to incorporate the handling of follow-up conflicts, the approach detailed in Oetting et al. (2013), which simultaneously supports the assessment of the developed conflict resolution alternatives, is of particular importance. Together with the identification of follow-up conflicts, the structure can be advanced to support the establishment of the conflict severity through the development of "probable" conflict resolution alternatives, as discussed in Oetting et al. (2013). With the development of a set of "probable" conflict resolution alternatives to establish the severity of the conflicts, the alternatives must also be communicated to the assessment module. In this case, securing a connection with the assessment module would permit to identify the most fitting alternative within a set of "probable" conflict solution alternatives, and as a result, the establishment of the severity of the identified conflicts (see subsection 2.2.3).

The structured approach guiding the CDCR process to fix the assembled PVSCS combinations $I_{S,o}$, as part of the dynamic DRP deployment system, is depicted in figure 11.1.

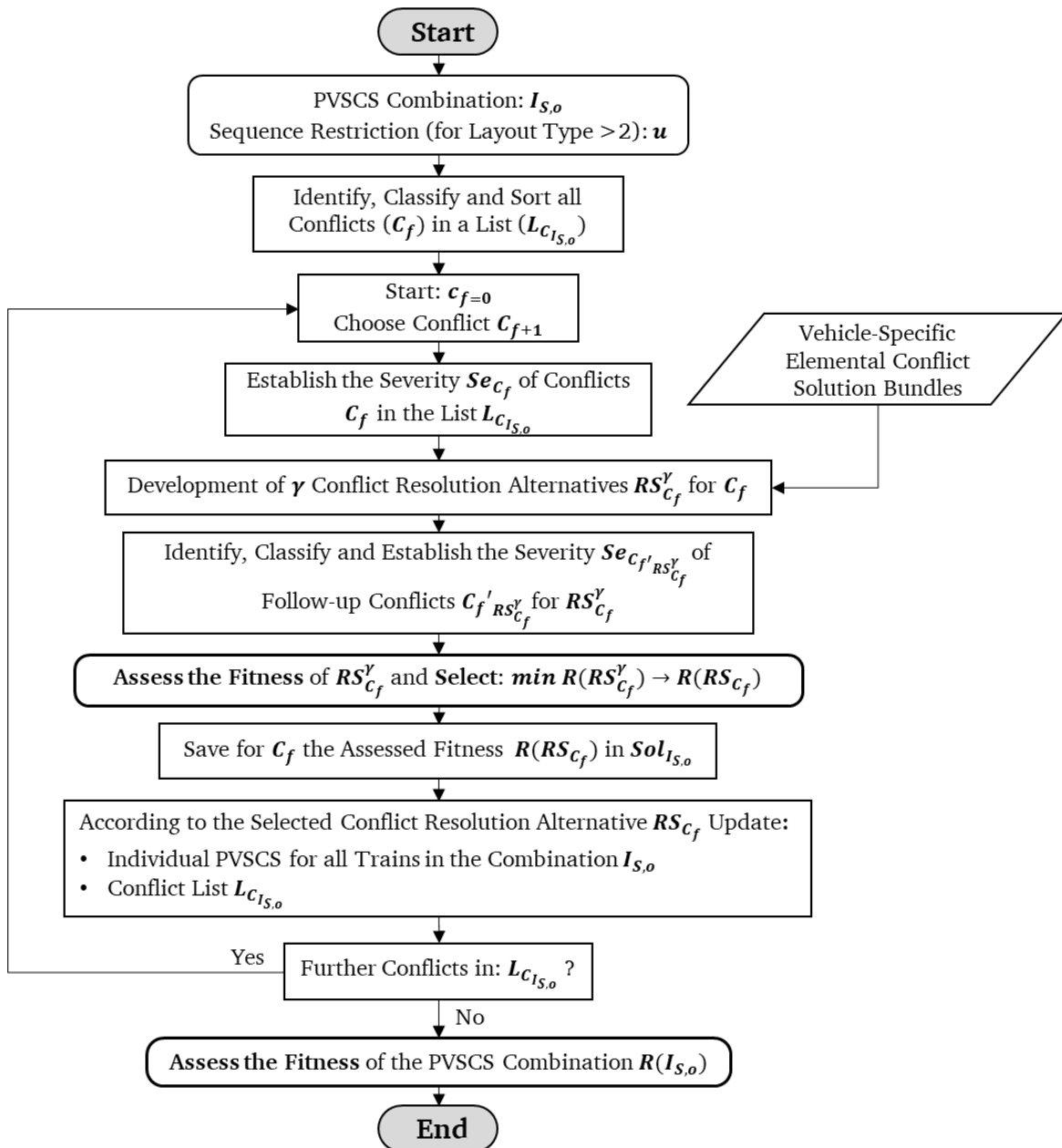

Figure 11.1 Structure of an automatic CDCR process relying on predefined elemental conflicts solution alternatives (by author)

The structured approach to conduct the CDCR process is constituted by eight overall steps, which support the four fundamental conflict identification and resolution processes and ultimately, allow generating the conflict resolution alternatives to fix a PVSCS combination $I_{S,o}$.

1. The CDCR process starts with an identification and classification of conflicts C_f in the PVSCS combination $I_{S,o}$ being handled. The identified conflicts are *sorted* following primarily their temporal occurrence (i.e. synchronously) in a conflict list $L_{C_{I_{S,o}}}$.
2. The first conflict C_f in the list $L_{C_{I_{S,o}}}$ is selected, and the severity Se_{C_f} of every conflict in the list $L_{C_{I_{S,o}}}$ is established so that it can be later assessed, as detailed in section 12.
3. Depending on the conflict type multiple conflict resolution alternatives $RS_{C_f}^y$ for the selected conflict C_f are generated. The conflict resolution alternatives are developed

- utilizing the predefined conflict solution alternatives for vehicle-specific conflicts and its bundled introduced in subsection 6.5.
4. For every conflict resolution alternative $RS_{C_f}^y$, its effects on the operating situation are projected and the follow-up $C_f'_{RS_{C_f}^y}$ are identified and classified. Once the follow-up conflicts are identified their severity is established $Se_{C_f'_{RS_{C_f}^y}}$ so that they can be later assessed as detailed in section 12. As discussed in subsection 3.5.2, supporting the identification of follow-up conflicts is critical for the assessment of resolution alternatives as they provide with a look-ahead on their influence on the operating situation.
 5. The effect $R(RS_{C_f}^y)$ on the operating situation of every conflict resolution alternative $RS_{C_f}^y$ is assessed, as detailed in the assessment module (see section 12).
 6. The conflict resolution alternative with the minimum effect $min R(RS_{C_f}^y)$ as established by the evaluation function detailed in section 12 is selected to solve conflict C_f and saved in the set of chosen conflict resolution alternatives $Sol_{I_{S,o}}$ as $R(RS_{C_f})$.
 7. Each PVSCS for every train in the combination is updated according to the selected RS_{C_f} together with the conflicts in the conflict list $L_{C_{I_{S,o}}}$.
 8. If there are still conflicts C_f in the conflict list $L_{C_{I_{S,o}}}$ the process returns to step 2 and if there are no more conflicts, the fitness of the combination $R(I_{S,o})$ can be established as detailed in section 12.

With the structured approach for the CDCR process established, every PVSCS combination assembled in the previous module can be made conflict-free (i.e. fixed). However, since the dynamic DRP deployment system addresses four different conflict types, the four fundamental CDCR processes embedded within the above-detailed approach require to be derived in much further detail. Therefore, subsection 11.4 provides a much detailed discussion regarding the identification, classification and sorting processes of the four vehicle-specific conflict types for their arrangement in the conflict list $L_{C_{I_{S,o}}}$. Subsection 11.4 also discusses the identification of follow-up conflicts. Thereafter, subsection 11.5 provides further details regarding the development of conflict resolution alternatives for each of the identified conflicts, utilizing the predefined elemental conflict solution alternatives for each of the vehicle-specific conflict types detailed in subsection 6.5. Considering that the establishment of the severity of all identified conflicts depends on the implementation of “probable” conflict resolution alternatives, the severity of the conflicts is also discussed in subsection 11.5.

11.4. Identification of Vehicle-Specific Conflicts and Conflict List Generator

The first three steps within the CDCR process are constituted by the identification of conflicts, their classification, and the establishment of a conflict list for the PVSCS combination $I_{S,o}$ under investigation. This subsection derives each of these processes, including the special handling of follow-up conflicts, which is instrumental for the assessment and selection of the conflict resolution alternatives (see section 12).

As discussed in subsection 11.3, the identification of the conflicts C_f , their classification, and their sorting in the conflict list $L_{I_{S,o}}$ should be conducted through a spatiotemporal contrast of every train’s PVSCS that constitutes the investigated PVSCS combination. A spatiotemporal contrast is necessary as the vehicle-specific CDCR process detailed in figure 11.1 is set to resolve any occurring

conflicts in both time and space across all four conflict types, namely occupancy, infrastructure availability, circulation and service conflicts, so as to develop the targeted conflict-free schedule. The identification of the conflicts C_f in the PVSCS combination is conducted in its entirety at the beginning of the CDCR process and every time a conflict solution has been established RS_{C_f} (see figure 11.1). Furthermore, depending on the infrastructure layout around the LtfTS (see figure 10.1), the PVSCS combination may contain an entrance sequence constraint u that must also be considered (see subsection 10.2).

This subsection initially provides a detailed look at the identification and classification structure for every conflict type (subsection 11.4.1). Later, subsection 11.4.2 describes the sorting of the already identified and classified vehicle-specific conflicts into one synchronous conflict list for the whole PVSCS combination.

11.4.1. Identification and Classification of Vehicle-Specific Conflicts

The identification and classification of the different conflict types are detailed in this subsection. As discussed in subsection 11.3.2, the identification process should be conducted separately for each of the vehicle-specific conflict types by taking into consideration the existing approaches and the system's requirements. Additionally, the classification of the conflicts ought to concentrate on the spatiotemporal characteristics of the identified conflicts and the available conflict resolution possibilities.

During the identification of each of the conflict types, observing their temporal occurrence has been deemed to be particularly important for their sorting in the conflict list (see subsection 11.2). While the temporal occurrence (i.e. time in which the conflict is registered in the system) of a conflict is a central classification aspect for the synchronous CDCR process, spatial aspects have also been recognized as being of importance for the dynamic DRP deployment system (see subsection 11.3). This is the case of the location in the network where the conflicts are identified. Conflicts that take place in the critical area may have particular relevance for the transition of the network to stable operations. Therefore, both the spatial and temporal characteristics of the identified conflicts must be supported for their classification in the conflict list.

The identification and classification of each of the vehicle-specific conflict types being handled within the dynamic DRP deployment system are detailed in the following subtitles.

Identification and Classification of Occupancy Conflicts

As discussed in subsection 2.2.3, occupancy conflicts occur when trains are not able to temporally or spatially follow their schedule, since this would lead to a simultaneous occupation of the same infrastructural element. Aligned with the infrastructural modelling utilized for the dynamic DRP deployment system, occupancy conflicts can take place in any of its three infrastructural elements. These elements are contained in the node-link arrangement and are recognized as tracks in links and switching zones and platform tracks in nodes (see subsection 5.1).

Following similar principles as in the approach proposed in Oetting et al. (2011) (see subsection 2.2.3) and aligned with the attributes from the infrastructural modelling (see subsection 2.2.2), the conflict identification is conducted specifically for each of the basic elements contained in the infrastructural model. Therefore, the identification of occupancy conflicts is conducted separately for links and nodes.

Identification of Occupancy Conflicts on Links

On links, the occupancy conflicts are reduced to two-train conflicts or conflict pairs. This allows removing some of the complexity out of the identification process, which is compensated by considering follow-up conflicts during the assessment and the assessment of the developed conflict resolution alternatives.

An occupancy conflict is identified when the difference in the departure time of trains $T_{l_s,i}$ and $T_{l_s,j}$ from the station S_a adjacent to the assessed link p is minor than the minimum headway time t_{minHT} attributed to the link respective to the model trains (MT) of the trains involved in the conflict. Thus, an occupancy conflict in a link is identified if equation 11.1 is satisfied.

$$t_{Proj.Dep}^{S_a}_{T_{l_s,j}} - t_{Proj.Dep}^{S_a}_{T_{l_s,i}} < t_{minHT}^p_{MT_i-MT_j} \quad (11.1)$$

The minimum headway time $t_{minHT}^p_{MT_i-MT_j}$ can be ascertained as detailed in equation 2.2 introduced in subsection 2.2.2, where the model train MT_i (see subsections 2.2.2 and 3.6.2) and driving direction of each of the conflict partners, are decisive parameters. Ultimately, the temporal occurrence t_{c_f} of an occupancy conflict identified in a link is registered as the earliest projected departure time among the conflict partners, from the station S_a adjacent to the assessed link (p).

Identification of Occupancy Conflicts in Nodes

Occupancy conflicts in nodes are assessed for switching zones and platform tracks without limiting the identification to a two-train conflict approach. Oetting et al. (2011, p. 9) explain: “As groups of station tracks and switching zones usually have more than one service channel in the sense of service theory, it is not sufficient to deal only with two-train-conflicts, as the interactions between the trains are more complex than on lines. Restriction to two trains could lead to endless loops in the algorithm that can be avoided when considering all trains momentarily in the group of track or switching zone.”. Therefore, single and multi over-occupation conflicts are acknowledged, as discussed in subsections 2.2.3 and 3.6.2.

The conflict identification on switching zones is conducted for all trains with a conflicting entrance or exit to and from a node, as evidenced through the matrix of conflicts (Matrix K) respective to the switching zone. For all trains with conflicting routes, a comparison between their arrival or departure times and the minimum headway time computed in the matrix of occupations (Matrix Z) for the respective routes, is conducted (see subsection 2.2.2). For trains arriving in the node, the arrival time at the node is the dominant parameter, and for trains leaving the node, the departure time is of importance. Furthermore, for trains driving out of the node towards the same track, the matrix of occupations (Matrix Z) already takes into consideration the occupancy time of the track's first block section (see subsection 2.2.2).

An example of the identification of an occupancy conflict in the switching zone ω_{S_a} of station S_a between two departing trains $T_{l_s,i}$ and $T_{l_s,j}$ that utilize a conflicting route $K_{\omega_{S_a}}$ can be identified in equation 11.2. An occupancy conflict between these trains is positively identified if equation 11.2 is satisfied.

$$t_{Proj.Dep}^{S_a}_{T_{l_s,i}} + t_{Z_{K_{\omega_{S_a}}}}^{\omega_{S_a}}_{MT_i-MT_j} > t_{Proj.Dep}^{S_a}_{T_{l_s,j}} \quad (11.2)$$

In equation 11.2, if the projected departure time of train $T_{l_s,i}$ from S_a utilizing route $K_{\omega_{S_a}}$ plus the total occupancy time $t_{Z_{K_{\omega_{S_a}}}}^{MT_i-MT_j}$ is higher than the projected departure time of train $T_{l_s,j}$ from S_a utilizing route $K_{\omega_{S_a}}$, an occupancy conflict in the switching zone exists. The total occupancy time $t_{Z_{K_{\omega_{S_a}}}}^{MT_i-MT_j}$ respective to the train combination and driving pattern is determined through equation 2.7 (see subsection 2.2.2).

For a widespread identification of occupancy conflicts in the switching areas, equation 11.2 should be modified according to the driving patterns of the investigated trains, as discussed in subsection 2.2.2. This entails modifying the equation to support the projected arrival or departure time of the trains to and from the nodes to match the respective driving patterns. Ultimately, the temporal occurrence t_{c_f} of an identified occupancy conflict in a switching zone, is registered as the earliest projected departure or arrival time to or from the investigated node amongst the trains involved in the conflict (considering the investigated driving pattern).

In platform tracks, occupancy conflicts are identified following the same principle described for switching areas. However, the total occupancy time $t_{Z_{Pt_{S_a}}}^{MT_i-MT_j}$ for a platform track Pt_{S_a} at a station S_a must be ascertained considering the driving patterns specially detailed for the platform tracks discussed in subsection 2.2.2. Furthermore, the occupancy time may need to be complemented with: a stopping time at the platform track $t_{stop_{T_{l_s,i}}}^{Pt_{S_a}}$, any waiting time that is included due to any previously explored conflicts solutions $t_{w_{T_{l_s,i}}}^{Pt_{S_a}}$, and any transition time t_{Trans} foreseen at the platform track. The type of transition between train services depends on the PVSCS $d_{T_{l_s,i}}$ of train $T_{l_s,i}$, which is contained in the PVSCS combination under investigation (see figure 11.1). The transition types handled within the dynamic DRP deployment system are: turn (t_{Turn}), coupling of trains (t_{Couple}) and decoupling of a vehicle composition ($t_{Decouple}$). All in all, equation 11.2 may be modified to include the necessary complements, as generalized in equation 11.3. An occupancy conflict between trains is positively identified if equation 11.3 is satisfied.

$$t_{Proj.Arr_{T_{l_s,i}}}^{Pt_{S_a}} + (t_{Z_{MT_i-MT_j}}^{Pt_{S_a}} + t_{stop_{T_{l_s,i}}}^{Pt_{S_a}} + t_{w_{T_{l_s,i}}}^{Pt_{S_a}} + t_{Trans_{T_{l_s,i}}}^{Pt_{S_a}}) > t_{Proj.Arr_{T_{l_s,j}}}^{Pt_{S_a}} \quad (11.3)$$

The temporal occurrence t_{c_f} of an identified occupancy conflict at a platform track, is registered as the earliest projected arrival time to the investigated node amongst the trains involved in the conflict (considering the investigated driving pattern).

Across switching zones and platform tracks, the exploration is conducted considering all trains projected to arrive or depart from and to the investigated node. By comparing the respective times and following the above-discussed approaches for each infrastructural element in the node, the single or multi over-occupation of such elements can be established. This has been further explained in subsection 2.2.3.

Identification and Classification of Infrastructure Availability Conflicts

As discussed in subsection 2.2.3, infrastructure availability conflicts take place when trains are not able to spatially follow their schedules due to the unavailability of the infrastructure. In the context of the dynamic DRP deployment system, infrastructural elements can be unavailable due to two main reasons:

- i) The disruption has made entire elements or certain of its attributes unavailable to support the movement of trains, as discussed in subsection 5.4.
- ii) The entrance sequence of potentially queuing trains to the LtfTS, which has been imposed by the Tabu Search to the PVSCS combination $I_{S,o}$, must be respected. Therefore, a potentially queueing train has the elements within the LtfTS temporally unavailable until all prior trains in the sequence u have reached their assigned platform tracks. This is not a typical utilization of the term infrastructure availability conflict, however, upholding the entrance sequence u of the potentially queuing trains to the LtfTS is central for the dynamic DRP deployment system (see subsection 11.2 and 10.5).

Infrastructure availability conflicts must be identified for all trains individually, abiding by the two cases described above.

- Infrastructure availability conflicts are positively identified if the considered train $T_{l_s,i}$ foresees the utilization of an affected infrastructural element or any of its attributes already identified in subsection 5.4.1. In order to support an exploration of potential rerouting alternatives for the affected train, the temporal occurrence t_{C_f} of this kind of infrastructure availability conflicts is registered as the arrival time of the train to the last node in the train's PVSCS before reaching the unavailable infrastructural element. In case the unavailable infrastructural element is located in a node (i.e. platform track or element within the switching zone), the temporal occurrence is registered as the arrival time of the train to the previous node.
- Infrastructure availability conflicts due to the entrance sequence u to the LtfTS are positively identified if the projected arrival time at the LtfTS of a train $T_{l_s,i}^h$ with a PVSCS $d_{T_{l_s,i}^h}$ is not compatible with the established entrance sequence u .

Therefore, a conflict exists if the sequence of projected arrivals π of all potentially queueing trains $T_{l_s,i}^h$ to the LtfTS, which is ordered from the earliest to the latest projected arrival $t_{Proj.Arr}^{LtfTS}$ (recorded at the moment the conflict is being identified), is not identical to the investigated entrance sequence u provided by Tabu Search algorithm for the PVSCS combination $I_{S,o}$. In the sequence of projected arrivals π , every train that fails to abide with the established entrance sequence u is identified as a conflicting train.

The conflict's location is recognized as the LtfTS and the temporal occurrence t_{C_f} is registered as the projected arrival of the conflicting train to the LtfTS.

Identification and Classification of Circulation Conflicts

As discussed in subsections 2.2.3 and 3.6.2, a circulation conflict occurs when the time difference between the arrival of a train service and the scheduled departure of the following train service in the train's adjusted circulation plan is not sufficient to accommodate the minimum transition time (see subsection 3.6.2). As discussed in subsection 3.6.2, the minimum transition time $\min t_{Trans}$ depends on the type of transition that is anticipated in the circulation plan of the assessed train. As discussed for the identification of occupancy conflicts, the transition types handled within the dynamic DRP deployment system are: turn to a service (t_{Turn}) and the coupling (t_{Couple}) as well as the decoupling of trains ($t_{Decouple}$).

Circulation conflicts can also occur due to the lack of assignment of a vehicle composition to a specific train service (see subsection 3.6.2). In the case of the dynamic DRP deployment system,

circulation conflicts deriving from the lack of assignment of vehicle compositions to a train service originate from the PVSCS combination (i.e. the overall inability of a line to address its vehicle availability conflicts) (see subsection 8.4.3). On the other hand, it must be considered that the appointment of more than one train to one train service has already been addressed during the assembly of the PVSCS combination under investigation (i.e. assembly of operationally compatible PVSCS combinations - see subsections 10.4.1, 10.6.1, 10.6.3).

In addition, as part of the requirements of the dynamic DRP deployment system already discussed within the operational validation of the PVSCS (see subsection 9.7.1), positive turns in any of the stations within the critical area during the transition to stable operations may also be problematic. Positive turns at any of these stations require trains to wait until their scheduled departure time. Therefore, positive turns derive in an idle consumption of capacity, which hinders the ability of the system to dissolve the train queue, and consequently, the transition to stable operations (see subsection 2.3.2 and 10.2). In consequence, regardless of the type of transition between train services, namely, turning, coupling or decoupling of trains, all transition types must be verified for transitions between train services throughout stations in the critical area that result in trains waiting for their scheduled departure times.

Consequently, abiding by the three general cases described above, circulation conflicts are identified for all train services in the PVSCS combination $I_{S,o}$ individually, as follows:

- A circulation conflict is positively identified if the difference between the scheduled departure of the train $T_{I_{S,i}}$ from station S_a after its transition from train service Q to R (assigned in the train's adjusted circulation plan) and its projected arrival time to the station is less than the minimum transition time $\min t_{Trans}$. Thus, a circulation conflict exists if equation 11.4 is satisfied.

$$t_{Sched.Dep_R}^{S_a} - t_{Proj.Arr_Q}^{S_a} < \min t_{Trans} \quad (11.4)$$

The temporal occurrence t_{C_f} of the conflict is registered as the scheduled departure time of the transition train service $t_{Sched.Dep_R}^{S_a}$ detailed in the train's adjusted circulation plan. For example, in the case of coupling, the departure time of the resulting vehicle composition after the coupling. Moreover, spatially, the conflict takes place at the infrastructural element (i.e. node), where the transition is projected to take place. It must be noted that this location can change throughout the CDCR process.

- A circulation conflict can also be positively identified if, at the starting station of an investigated train service, there is no vehicle composition available. The temporal occurrence t_{C_f} of these circulation conflicts are registered as the scheduled departure of the conflicting train service from the starting station. In case the conflicting service is included within the affected line's reachability conflicts Trc_{I_S} , the conflict location is derived, as explained in 8.4.4.
- Finally, for transitions scheduled within the critical area, a circulation conflict can be positively identified not only if equation 11.4 is satisfied but also in cases in which the difference is larger than the minimum transition time. As a result, circulation conflicts throughout stations within the critical area are positively identified if equation 11.5, is not satisfied.

$$t_{Sched.Dep_R}^{S_a} - t_{Proj.Arr_Q}^{S_a} = \min t_{Trans} \quad (11.5)$$

This kind of circulation conflict is especially relevant within the dynamic DRP deployment system, as it would allow supporting the faster transition of the disrupted network to stable operations. The temporal occurrence t_{C_f} of this kind of circulation conflicts are registered as the moment the train would begin waiting for its scheduled departure after the transition between train services has been completed. Therefore, the temporal occurrence of the conflict t_{C_f} is registered as the projected arrival time of the train to the station where the transition between train services is scheduled to take place $t_{Proj.Arr}^{S_a}$ plus the minimum transition time, as generalized in equation 11.6.

$$t_{C_f} = t_{Proj.Arr}^{S_a} + \min t_{Trans} \quad (11.6)$$

Finally, depending on the computational effort available, the identification of this kind of circulation conflicts can be further limited within the critical area to focus only on the LtfTS.

Identification of Service Conflicts

Service conflicts are identified as a way to account for the passengers' welfare within the system (see subsection 3.7.2). Service conflicts occur in case the cancellation of a train service at one or multiple nodes generates a service interval considered to be detrimental to the welfare of the affected passengers. Within the dynamic DRP deployment system, the generated service interval should not be larger than the maximum service interval, which is equal to the service interval foreseen in the DRP operating concept for the line respective to the cancelled service (see subsection 3.7.2).

In overall, the identification of service conflicts is conducted following a very similar approach as the one discussed in subsection 8.4.5 for the classification of reachability conflicts. The principles utilized at the line-specific level may be applied at the vehicle-specific level for all trains services. However, since the PVSCS combination being fixed by the CDCR process contains one PVSCS of every train circulating in the network (see subsection 10.6.1), the service intervals can be ascertained with further certainty.

Initially, to ascertain the service interval $t_{SI}^{S_a}$ generated by the cancellation of service Q at the affected station S_a , it is necessary to identify the prior and subsequent train services projected to reach the affected station. With the PVSCS combination $I_{S,o}$ already assembled, it is possible to identify with enough precision the subsequent and prior train services that may reach the affected station. As discussed in subsection 8.4.5 and 3.7.2, the identification is conducted by recognizing the immediately prior and subsequent train services projected to reach the affected station. These train services must contain within their schedules the same end station as the cancelled train service as well as the same stations along their route (see subsection 6.3.13). Furthermore, the projected departure times of both the prior and subsequent train services from the affected station can be derived from observing the operational circumstance of the train services in the PVSCS combination throughout the CDCR process. Therefore, the generated service interval $t_{SI}^{S_a}$ can be ascertained by subtracting the projected departure time from station S_a of the prior train service P from the projected departure time of the subsequent train service R , as detailed in equation 11.7.

$$t_{SI}^{S_a} = t_{Proj.Dep}^{S_a} - t_{Proj.Dep}^{S_a} \quad (11.7)$$

Moreover, the identification of the maximum service interval for a cancellation of train service Q must be done by paying close attention to the existence of cycle variants in the operating program

of the cancelled train service's line and DRP operating concept, as disused in subsection 8.4.5. The cycle variant respective to the end station of the cancelled service must be selected for the establishment of the maximum service interval as detailed in equation 8.26 and generalized in equation 11.8.

$$t_{SI,max_G} = \begin{cases} t_{SI,DRP,l_S,\psi} \\ \dots \\ t_{SI,DRP,l_S,\psi} \end{cases} \quad (11.8)$$

As a result, a service conflict is positively identified if the service interval $t_{SI_Q}^{S_a}$ generated by the cancellation of service Q at station S_a is larger than the maximum service interval $t_{SI,max_{Q,DRP,l_S,\psi}}$, as discussed in subsection 8.4.5 (see equation 8.27) and generalized in equation 11.9.

$$t_{SI_Q}^{S_a} > t_{SI,max_{Q,DRP,l_S,\psi}} \quad (11.9)$$

The above-explained process must be conducted throughout all the stations affected by the cancellation of the train service.

Since the cancellation of a train service can produce different service intervals at each of its affected stations, service conflicts are identified individually for every station. However, considering that they derived from the same conflict resolution alternative, they must be handled altogether. Thus, all service conflicts positively identified throughout more than one station are clustered all together. As a result, the service conflicts positively identified as generalized in equation 11.7 for every affected station are clustered in a set as generalized by equation 11.10.

$$C_f = \{t_{SI_Q}^{S_a}, \dots, t_{SI_Q}^{S_z}\} \quad (11.10)$$

Furthermore, as discussed throughout subsection 6.3.5 and 6.3.10, there are measures which would derive in the need to partially cancel certain train services. For example, the early turning of a train, the coupling of a train, or a transfer to the opposite side in case of a complete blockage (see subsection 6.3.10). It must be noted that with the development of different PVSCS for every train in the network as part of the dynamic DRP deployment system's overall approach (see subsection 3.5.2), service conflicts must also support the implementation of the line-specific conflict solutions on the original schedule. Therefore, the partial or total cancellation of a train service as a result of having these measures implemented within the PVSCS in the combination must be supported.

For that reason, there are two sources that must be considered for the identification of service conflicts in the PVSCS combination $I_{S,o}$ under consideration, as detailed below.

- i) Service conflicts that are generated by the implementation of conflict resolution alternatives during the fixing of the PVSCS combination $I_{S,o}$. In this case, the service conflicts are directly induced during the fixing of a PVSCS combination throughout the automatic CDCR process by the implementation of vehicle-specific elemental conflict solutions (e.g. early turning a train, developing an alternative train service).
- ii) Service conflicts that are generated as the result of implementing line-specific conflict solutions. In this case, the identification of service conflicts can be conducted by taking into consideration different approaches.

For example, considering all stations affected in the original schedule of a train due to the implementation of the PVSCS of every train in the PVSCS combination $I_{S,o}$ being fixed. However, this approach would not take into consideration the disrupted operations, the existence of the DRP operating programs, or the approach behind the dynamic DRP deployment system.

Therefore, an approach that takes into consideration the specific circumstances of every train the moment the system is being deployed in correspondence with the DRP operating concept must be advanced. In order to support these matters, the original cluster of every train identified during the set-up of the DRP operating concept becomes useful once again (see subsection 7.3.2).

As a result, the stations which are affected by the implementation of the line-specific elemental conflict solution of the different train PVSCS in the current combination $I_{S,o}$ can be ascertained as follows:

- *Green+ and Red+ trains* should reach their end station. Thus, any station not contained within the train's PVSCS used to assemble the PVSCS combination under investigation that is contained in the schedule of the train's current train service must be assessed for a service conflict.
- *Green trains* should be able to follow the DRP operating concept of their affected lines. Thus, any station included in the DRP operating program that is not included in the PVSCS used to assemble the PVSCS combination under investigation must be assessed for a service conflict.
- *Yellow trains* should be capable of reaching all the stations in their current train service up to their end station (e.g. LtFTS during a complete blockage), as discussed in subsection 2.3.3. Thus, any station not contained within the train's PVSCS used to assemble the PVSCS combination under investigation that is contained in the schedule of the train's current train service must be assessed for a service conflict.

Finally, under consideration of the structured approach (see subsection 11.3), in order to support the sorting of service conflicts in the conflict list, it is necessary to recognize their temporal and spatial occurrence. As a result, the temporal occurrence t_{C_f} may be registered equal to cancelled train service's scheduled departure from the first station affected by the cancellation. The spatial occurrence of the conflict must be acknowledged across all affected stations.

Identification of Follow-up Conflicts

As established by the structured approach (see figure 11.1), follow-up conflicts C_f' are identified every time a conflict resolution alternative $RS_{C_f}^V$ has been developed. As discussed in subsection 2.2.3, the identification of follow-up conflicts derives from projecting the implementation of the conflict resolution alternative on the actual operating situation.

In overall, there are two underlying differences between already identified and follow-up conflicts:

- First, until a conflict resolution alternative is selected and implemented (see section 12), follow-up conflicts only represent a projection or a 'look-ahead' on the operating situation.
- Second, follow-up conflicts are identified with the purpose of accounting for the changes introduced to the actual operating situation. As discussed in subsection 2.2.3, the changes are constituted by a variation on the number of conflicts identified (i.e. induced conflicts and indirectly resolved conflicts) and their severity (Oetting et al. 2013).

Within the dynamic DRP deployment system, the changes introduced to the actual operating situation are derived as a function of the elemental conflict solution measures involved in the development of the resolution alternatives (see subsection 6.3). Furthermore, depending on the conflict type being addressed by the developed conflict resolution alternative, the changes may concentrate on different aspects of the operating situation (e.g. circulation between train services).

As a result, follow-up conflicts are based over a projection of the operating situation following the prospective implementation of one conflict resolution alternative $RS_{C_f}^Y$ developed to address a particular conflict C_f in the conflict list. The identification of conflicts induced by projecting the conflict resolution alternative on the actual operating situation $C_f'_{RS_{C_f}^Y}$ (i.e. follow-up conflicts) may be conducted through the same methods discussed in previous subtitles in this subsection.

All in all, through the attainment of the induced follow-up conflicts $C_f'_{RS_{C_f}^Y}$, the system is able to acquire an effective look-ahead capability for the assessment of the developed conflict resolution alternatives.

11.4.2. Conflict Sorting and Conflict List Creation

The sorting of the conflicts C_f in the conflict list $L_{I,S,o}$, is conducted for all the identified conflicts regardless of their type. As discussed in subsection 2.2.3, listing all identified conflicts regardless of their conflict type in one single conflict list would allow their synchronous resolution as required in subsections 11.2 and 3.4.2.

The sorting of the conflicts in the list is performed systematically until all conflicts have been arranged in the conflict list. Since it is possible that more than one conflict is registered at the same time, the sorting of conflicts needs to observe other attributes. Additionally, the spatial occurrence of the conflicts also plays an important role within the dynamic DRP deployment system (i.e. conflict that takes place within the critical area), as discussed in subsection 11.2. For this purpose, the structured approach discussed in subsection 11.3 foresees considering not only the temporal occurrence of the conflicts but also the location in the network in which they have been identified while paying particular attention to the critical area of the disrupted network (see subsection 3.6.2).

As a result, the process for sorting of conflicts in the conflict list established in this subsection considers three orders of relevance. At the outset, the sorting of the identified conflicts first considers the temporal occurrence of the identified conflicts. Later, the spatial characteristics, more specifically, the location of the identified conflict in the network vis-à-vis the disrupted section is taken into consideration. Finally, to further differentiate between conflicts that take place within the critical area, conflicts that have a direct influence on capacity consumption at the LfTS are considered as more important. This would allow to further reinforce the handling of potentially queuing trains in the network as their handling may be of relevance for the whole network (see subsection 2.3.3 and 10.3.1).

With the spatiotemporal characteristics of each of the identified conflicts already established, their sorting in the list can be performed immediately. The sorting is conducted abiding by the three orders of relevance, as detailed below.

-
- i) The first level observes the temporal occurrence t_{C_f} of the conflicts and arranges all the identified conflicts in the list from the earliest to the latest occurrence.
 - ii) The second level recognizes all conflicts with the same temporal occurrence and concentrates on their spatial occurrence. Conflicts are further arranged vis-à-vis their distance to the disrupted section, listing at the top conflicts that transpire the nearest to the disrupted section (i.e. LtTTS). This would inherently give further relevance to the conflicts within the critical area.
 - iii) Finally, for conflicts that occur in the same location, those that engender the capacity of the LtTTS are listed first. This entails listing at the top occupancy and circulation conflicts.

Finally, since conflicts must be updated every time a conflict resolution is selected (see figure 11.1), the sorting of the conflicts in the list is done accordingly. This entails that not only the spatiotemporal characteristics of the identified conflicts are updated, but also existing conflicts can be removed or added to the list.

11.4.3. Summary

Each of the specific processes developed within this section is focused on the identification of the vehicle-specific conflicts within the PVSCS combination under investigation. The processes advanced in this subsection are set to identify and classify each of the four conflict types handled by the dynamic DRP deployment system. All identified conflicts are ultimately sorted in a conflict list following three different sorting levels, which prioritizes the sorting based on the temporal occurrence.

Furthermore, the approaches advanced within this section have also been tailored to identify conflicts that derive from the system's overall approach and allow supporting the proficient handling of the disrupted operations. This is the case of service conflicts and also infrastructure availability conflicts due to a conflicting entrance sequence to the LtTTS.

Moreover, the general approach for the identification of follow-up conflicts has also been briefly discussed. These are instrumental for the assessment and selection process (section 12) of the conflict resolution alternatives developed in the following subsections.

Finally, the approaches advanced within this section are also valid for handling the information from other types of railway traffic and other railway companies. Depending on the extent to which the information is available (i.e. schedule and circulation plans) occupancy, infrastructure availability and circulation conflicts can be identified. However, since the purpose of the dynamic DRP deployment system is to utilize the information of other types of railway traffic to find better solutions for the commuter railway trains that are being rerouted outside the commuter railway network, limiting the handling of these trains to occupancy conflicts may be sufficient (see subsection 3.3.2)

With the conflicts identified, classified and sorted in a synchronous conflict list, the following subsection advances the structured development of the conflict resolution alternatives.

11.5. Development of Vehicle-Specific Conflict Resolution Alternatives

The development of the different conflict resolution alternatives discussed in this subsection is derived according to the requirements discussed in subsection 11.2 and the structured approach detailed in subsection 10.3. Thus, it seeks to merge the predefined elemental conflict solution

alternatives for all four conflict types with their solution approaches discussed in subsections 6.3 and 6.5 in order to solve the identified conflicts. In this way, the development of the different conflict resolution alternatives across all four conflict types, namely occupancy, infrastructure availability, circulation and service conflicts, can be conducted as foreseen in the structured approach (see figure 11.1).

In the previous step, the spatiotemporal aspects of the different PVSCS of every train contained within the PVSCS combination $I_{S,o}$ under investigation allowed to identify and classify different conflicts C_f within the conflict list $L_{I_{S,o}}$. While the temporal occurrence of the identified conflicts is central for their handling within a synchronous CDCR process, the spatial circumstances behind their occurrence are also relevant. Since the handling of trains within the critical area (e.g. queuing trains) is essential to ensure the transition to stable operations, conflicts identified across infrastructural elements within the critical area are particularly significant. Therefore, special attention must be given to the spatiotemporal characteristics of the identified conflicts in order to secure the effectiveness and efficiency of the process for the development of the conflict resolution alternatives γ .

This subsection closes the loop on the CDCR process by detailing the development of the conflict resolution alternatives $RS_{C_f}^\gamma$ for each of the vehicle-specific conflict types handled within the dynamic DRP deployment system. Furthermore, the framework for the handling of follow-up conflicts is further expanded within this subsection by providing the means to derive the “probable” conflict resolution with which the severity of the conflicts is ascertained.

Overall, the subsection is divided into five parts. Subsection 11.5.1 discusses the development of conflict resolution alternatives for occupancy conflicts. Subsection 11.5.2, utilizes the same structure detailed in 11.5.1 and introduces the necessary modification to address the two kinds of infrastructure availability conflicts (see subsection 11.4.1). Subsections 11.5.3 and 11.5.4 provide a detailed account of an innovative approach for the development of conflict resolution alternatives for circulation and service conflicts. Finally, subsection 11.5.5 makes use of the structures introduced to develop the conflict resolution alternatives of every conflict type and discusses the development of the “probable” conflict resolutions to support asserting the severity of the identified conflicts.

11.5.1. Development of Conflict Resolution Alternatives for Occupancy Conflicts

The process supporting the development of resolution alternatives $RS_{C_f}^\gamma$ for occupancy conflicts detailed in this subsections is to be designed so as to focus on the effective and efficient development of resolution alternatives, while taking into account the need for a special handling of conflicts within the critical area (as required in subsection 11.2). This subsection provides further insight into the development of resolution alternatives to address the occupancy conflicts C_f identified in the conflict list $L_{I_{S,o}}$ of the PVSCS combination $I_{S,o}$ being fixed.

At the outset, the conflict resolution process relies on the predefined bundles of elemental conflict solution alternatives derived in subsection 6.5 (see subsection 3.5.2). The details behind the implementation of each of the elemental conflict solution alternatives have been discussed throughout section 6 and must be considered for the resolution of occupancy conflicts. Furthermore, these elemental conflict solution alternatives must be introduced in the general conflict resolution approach proposed in Oetting et al. (2011), which outlines the development of

the conflict resolution alternatives for occupancy conflicts in this module, as discussed in subsection 11.3.

An overview of the elemental conflict solution alternatives for occupancy conflicts can be appreciated in figure 6.5. The figure contains the four elemental conflict solution alternatives listed below, including the possibility to combine each other as a means to enhance the overall quality of the resulting resolution alternatives.

- Shifting trains in time - STT (see subsection 6.3.8)
- Rerouting trains – RRT (see subsection 6.3.11)
- Early turning trains – ETT (see subsection 6.3.6)
- Combination of alternatives

The ability to combine the elemental conflict solution alternatives has been ascertained during the establishment of their bundle (see table 6.3). As a result, every train involved in the conflict can have developed at least seven conflict resolution alternatives. The complexity behind the development of different resolution alternatives can be further advanced by the infrastructural situation at hand. For every measure, there is the possibility to generate more than one plausible conflict resolution alternative by considering different infrastructural elements. However, the number of resolution alternatives to be explored at once can also be limited by considering the operational circumstances in which the occupancy conflict takes place. The adept selection of the elemental conflict resolution measures and the infrastructural elements utilized to effectively and efficiently address the identified occupancy conflict constitutes the most significant challenge to be dealt with in this subsection.

For the resolution of occupancy conflicts in the conflict list $L_{I_s,o}$ the already discussed partition between conflicts in nodes and conflicts on links is maintained. As discussed in subsection 2.2.3, maintaining this separation allows a guided implementation of conflict resolution alternatives; thus, an effective and efficient conflict resolution process. The following subtitles provide a detail description regarding the development of the conflict resolution alternatives for occupancy conflicts on links as well as nodes, also distinguishing between conflicts that occur inside and outside of the critical area.

Development of Conflict Resolution Alternatives for Occupancy Conflicts on Links

As discussed in subsection 2.2.3, Oetting et al. (2011) propose a simple approach for the development of conflict resolution alternatives for occupancy conflicts that take place on links. However, the generalization and streamlining of this approach within the CDCR process would not satisfy the dynamic DRP deployment system's requirements, since it would dismiss the development of suitable resolution alternatives, particularly, within the critical area. On the other hand, the conflict resolution approach proposed by Oetting et al. (2013) would deliver more exhaustive exploration of resolution alternatives by taking into consideration further characteristics of the conflicting situation and a more extensive range of solutions (e.g. rerouting) (see subsection 2.2.3). However, since the approach introduced by Oetting et al. (2013) is advanced on a microscopic infrastructure modelling technique (see subsection 2.2.3), it is not immediately compatible with the dynamic DRP deployment system (see subsection 5.1).

Considering that the CDCR process must be conducted for all the PVSCS combinations generated by the previous module (see section 10) and that there may be an extensive number of conflicts which need to be solved due the consideration of an empty network during the development of

each PVSCS (see section 9), a hybrid approach that merges both existing approaches is more compatible with the module's requirements. A hybrid approach would permit to differentiate between different areas of the network and permit to derive a much more exhaustive process for the more relevant areas (i.e. critical area – see subsection 3.6.2).

On the one hand, a more straightforward process established to solve conflicts outside the critical area would support an effective handling of conflicts in most parts of the network. On the other hand, given the relevance of the critical area for the whole disruption-management (see subsection 2.3), a much more exhaustive and robust exploration of solution alternatives and the conflicting situation may still be advanced within the critical area.

As a result, a simplified development of conflict resolution alternatives may support addressing occupancy conflicts on links outside the critical area, which may also be enhanced to maintain a prompt but effective resolution of the identified conflicts. Furthermore, a limited version of the exhaustive development of conflict resolution alternatives can be advanced to address occupancy conflicts on links within the critical area. Such an approach would support the resolution of the train queue before the LtTTS, secure the transition of the network to stable operations, and reassure the development of not only conflict - but a deadlock-free schedule. Both of these approaches are detailed below.

Outside the Critical Area

For links outside the critical area, the development of conflict resolution alternatives maintains a simple structure while at the same time supports the development of various conflicts resolution alternatives for the two-train occupancy conflicts C_f .

To address occupancy conflicts on links outside the critical area, two (i.e. RRT, ETT) conflict resolution alternatives may be used as a complement to the exploration of resolution alternatives based solely on the shifting the conflict partners in time (see subsection 2.2.3, Oetting et al. 2011).

Initially, while the rerouting of a train (RRT) may prove useful to address occupancy conflicts, it requires a spatial exploration of different routing possibilities across nodes and links. Under these circumstances, the measure generates a considerable risk of deriving new multi over-occupation conflicts within the nodes. The likelihood of inducing new occupancy conflicts is particularly high within commuter railway operations due to its usually dense operating programs (see subsection 2.2.1), predominantly, throughout the core area of the network (see subsection 3.6.2). Thus, to limit the overall complexity of the problem, the rerouting of trains can be discarded as a possibility. Furthermore, the robust influence of the early turning of trains (ETT) on the operating situation of the network is enough motive to dismissed its usage outside of the critical area (see subsection 6.3.6).

As a result, outside of the critical area, occupancy conflicts between trains are resolved simply by considering the shifting of trains in time (STT), similarly to the approach introduced by Oetting et al. (2011).

The conflict resolution alternatives for occupancy conflicts on links outside the critical area are generated utilizing the two generic steps detailed below.

1. STT: When both trains drive in the same direction, the departure time from the node adjacent to the conflicting link of the latest conflict partner is shifted in time. Thus, a waiting time t_w is assigned to the train until the minimum headway time for the

corresponding track $t_{min HT}$ is respected (see equation 11.1). When trains drive in opposite directions (i.e. single track operations), the departure time of the latest conflict partner from its respective node adjacent to the conflicting link is shifted in time. A waiting time t_w is assigned until the minimum headway time for the corresponding track $t_{min HT}$ is respected (see equations 11.1).

2. The measures are implemented as detailed in step 1 on the remaining conflict partner.

However, for occupancy conflicts in which the conflict partners drive in opposite directions (i.e. single track operations), either because there is only one track available or the infrastructure layout requires such operations, some exceptions must be considered. Under these circumstances, to improve the quality of the resolution alternatives and reduce the likelihood of engendering a potential deadlock, the generation of resolution alternatives is expanded not only to both conflict partners but also in space. Therefore, for the three steps discussed above, the following three remarks must be observed:

- i) If possible, the entrance of the earliest partner to the node adjacent to the conflicting link is shifted in time. This would add a waiting time t_w at the end of the previous link adjacent to the node (considering the driving direction of the handled train), and support the utilization of the switching zones after the platform tracks for the conflict partner driving in the opposite direction. The magnitude of the waiting time t_w is established so that the departure of the latest conflict partner from the node adjacent to the investigated link is conflict-free; thus, avoiding conflicts in the switching zones or platform tracks (only considering the conflict partners) and considering equations 11.2 and 11.3.
- ii) The measure is implemented as detailed in i) on the remaining conflict partner.
- iii) If there are no feasible conflict resolution alternatives generated until this point, the exploration must include the node previous to the one adjacent to the conflicting link.

Inside the Critical Area

Inside the critical area, occupancy conflicts on links play a decisive role in supporting the dissolution of the train queue; therefore, for the transition for the disrupted network to stable operations. Regardless of the existence of a total or partial blockage, an exploration of the conflict resolution alternatives that can be developed must be much more exhaustive.

The number of links within the critical area is much smaller when compared to the total number of links across the whole network. Consequently, a much thorough exploration of conflict resolution alternatives can be supported. Under these circumstances, the three elemental conflict solution alternatives in the bundle structured to address occupancy conflicts may be utilized to develop the conflict resolution alternatives for links inside the critical area.

Nonetheless, the elemental conflict solution alternatives are, for the most part, measures that must be applied within nodes; in consequence, the likelihood that they engender new occupancy conflicts in the nodes arises. As discussed in subsection 2.2.3, the handling occupancy conflicts within nodes can be a complicated procedure due to the existence of multi over-occupation conflicts. The situation is exacerbated if the three elemental conflict solution alternatives are combined for every partner in the conflicting pair, and all available infrastructural elements are considered for the development of the conflict resolution alternatives. Therefore, the enhancement of the approach introduced by Oetting et al. (2011) to support the development of conflict resolution alternatives for links in the critical area can be conducted in multiple ways.

Initially, the approach can consider all three elemental conflict solutions and generate different resolution alternatives by including in parallel the interaction with other trains within the node. This approach would entail that the conflict resolution alternatives for the two-train occupancy conflict are established by dealing systematically with conflicts on links and nodes. Under these circumstances, the resolution of conflicts on links will result in long computational loops as it would require conducting the conflict solution within the nodes in the same step.

On the other hand, a more straightforward approach can be advanced by generating general solutions and restricting their effects on the operating situation to follow-up conflicts that can be easy to assess (i.e. single over-occupation). This approach can widen the possibilities to handle the conflicts without requiring a complex structure, leaving the follow-up conflicts in the node to be handled in a separate conflict resolution step.

The generation of the resolution alternatives can be advanced following both approaches as a function of the computational requirements imposed on the system. The development of the conflict resolution alternatives depending on the computational effort is advanced in the four generic steps detailed below.

1. STT: The implementation of a shift in time is conducted as explained for links outside the critical area and including remarks number *i*), *ii*) and *iii*).
2. The measures are implemented as detailed in steps 1 on the remaining conflict partner.
3. RRT: As detailed in subsection 6.3.11, for every conflict partner different the entrance and/or existing routes throughout the node (i.e. including changes in the platform tracks), which allow to solve the conflict and at the same time guarantee the train is able to reach the subsequent nodes detailed in its PVSCS, are explored. The exploration of the routing possibilities relies on the node's matrix of reachability (i.e. Matrix E, see subsection 5.1.1). Therefore, the rerouting possibilities are explored across both nodes adjacent to the conflicting link (including different routes through the link as well). Rerouting alternatives that require utilizing specific tracks generally utilized in the opposite driving direction but are technically capable of supporting the desired movement (i.e. count with the adequate signalling) may also be explored. However, in this case, a verification of the train's capability to follow its PVSCS throughout the subsequent nodes is of critical relevance.
 - Conflict resolution alternatives that allow the rerouting of the conflict partners without generating any single or multi over-occupation conflicts in the node are directly generated.
 - Since their effect on the operating situation can be immediately assessed during the assessment process through the follow-up conflicts (see section 12), conflict resolution alternatives that still generate new single over-occupation conflicts in the nodes are allowed as long as no conflict-free free option exists.
 - Alternatives that derive multi over-occupation conflicts may be either limited or depending on the computational effort, the steps for conflict resolution in nodes can be conducted.
4. ETT: Due to its robust influence on the operating situation (see subsection 6.3.69, the implementation of the measure must be operationally justified. Therefore, the conflict resolution alternatives that incorporate this measure must fulfill the following requirements:
 - a) The occupancy conflict must take place in a link previous to a LtFTS or between any of the turning stations within the critical area.

- b) If both conflict partners drive towards the LtFtS, the measure can only be applied to the latest partner in the two-train conflict.
- c) If the partners in the two-train conflict drive in opposite directions, the measure can only be applied to the member driving towards the LtFtS.
- d) The waiting time t_w assigned to the train affected by the measure to solve the conflict (computed as in step 1 or 3), must be larger than the minimum turning time $\min t_{Turn}$.

Under the circumstances detailed above, the early turn, as described in subsection 6.3.6, can be generated as a conflict resolution alternative. Overall the implementation of the measure requires, securing the entrance of the train to the station, assigning a platform track where it can conduct the change in its driving direction and appoint the necessary transition time (i.e. minimum turning time) according to the number of drivers in the train (see subsection 5.4.2).

- The measure can be combined with the rerouting of the train (RRT) in order to explore the different platform track alternatives that support the turn and allow the train to support and fulfill its PVSCS.
- Alternatives in the previous point which generate follow-up conflicts within other trains in the node can be refined by combining them with step 1 (STT) on each of the conflict partners to avoid new conflicts in the respective nodes.
- Alternatives that engender multi over-occupation conflicts can be immediately discarded or depending on the computational effort, the steps for conflict resolution in nodes can be conducted.

Development of Conflict Resolution Alternatives for Occupancy Conflicts in Nodes

Developing conflict resolution alternatives within nodes can be a potentially complex task. Between switching zones and platform tracks, trains cannot be assigned a waiting time to respect the minimum headway time. Therefore, limiting the exploration of resolution alternatives to the handling of two trains would require many or even endless iterations (see Oetting et al. 2011). As discussed in subsection 2.2.3, the approach proposed by Oetting et al. (2011) handles all trains involved in an occupancy conflict within the node in parallel by distinguishing conflicts between single and multi over-occupation of the node elements.

On the other hand, the proposed structure does not support all the elemental conflict solution alternatives handled by the system, nor it is able to deal with the queuing trains within the critical area. By maintaining the difference between the handling of conflict in nodes inside and outside of the critical area (as with track elements), the approach from Oetting et al. (2011) can be retrofitted to support a wider array of elemental conflict solution alternatives. The enhancement of the structure proposed by Oetting et al. (2011) is detailed in the following subtitles.

Outside the Critical Area

The development of the conflict resolution alternatives within the nodes is conducted for conflicts within any of the elements that constitute the node; thus, the switching zones entering the node, its platform tracks and switching zones leaving the node. As discussed in subsection 2.2.3, the process of developing conflict resolution alternatives is performed differently depending on the operating situation in which the conflict has taken place, namely, single or multi over-occupation.

In the case of single over-occupation (see subsection 3.6.2), the existing framework solves the conflicts for a two-train conflict with a shift in time, the rerouting of the conflicting trains or a combination of these strategies. However, aligned with the CDCR process as part of this module, the following conflict resolution alternatives may be considered: STT, RRT and ETT. While the first two measures are already included in the existing approach (see subsection 2.2.3), the early turn may be introduced as a complement.

As discussed for links outside the critical area, due to its robust influence on the operational circumstances of the network (i.e. its robustness), implementing an early turn of trains (ETT) to address occupancy conflicts is not operationally justifiable as elemental conflict solution alternative.

The development of conflict resolution alternatives to address single over-occupation conflicts in nodes outside the conflict area is advanced based on the two generic steps detailed below.

1. STT: The implementation of a shift in time is meant to assign waiting times t_w at the entrance of the station (i.e. end of the link adjacent to the node – at the home signal) or at the platform track. This alternative must be explored individually for every train involved in the conflict, depending on the driving direction of the trains. The trains are individually shifted in time so as to respect the minimum headway time respective to the model trains of the affected infrastructural element.
2. RRT: The exploration of different routes for every train involved in the conflict is conducted in the investigated node. The investigation of different routing alternatives includes the use of following tracks generally utilized in the opposite driving direction, which require an additional verification on the subsequent node. The routing alternatives (i.e. including changes of the platform tracks) within the node must guarantee that the conflict partners can fulfill the rest of their PVSCS. If routing alternatives in the node have been ascertained, but these engender follow-up conflicts with other trains, they can be further refined by combining the RRT with step 1 (STT) affecting only the trains involved in the conflict.

Ultimately, if there are no feasible conflict resolution alternatives generated (i.e. all derive in new single or multi over-occupation conflicts, despite the refinement of the solutions), the exploration must be expanded in space to include the node previously visited by each of the conflict partners. All solutions generated up until that moment must be discarded, and new resolution alternatives are developed.

In the case of multi over-occupation, the process is conducted as discussed subsection 2.2.3 and complemented by the elemental conflict resolution alternatives detailed above. However, since it is possible that no conflict-free solutions can be generated for all the trains involved in the multi over-occupation conflict by only handling the conflicting trains, the solutions that induce conflicts with up to one train (i.e. single over-occupation) are further processed in the same step, and the rest can be discarded. These conflicts are handled as single over-occupation conflicts within the same step. The conflict resolution alternatives must remove at least one of the trains from the multi over-occupation conflict. If no conflict resolution alternatives allow doing so, the exploration must be expanded in space to include the node previously visited by each of the train involved in the multi over occupation conflict (Oetting et al. 2011).

Inside the Critical Area

Inside the critical area, the same principles discussed for nodes outside the critical area are applicable; however, the elemental conflict resolution alternatives are complemented by an early turning of trains. Therefore, depending on the operating situation, the ETT can be applied and combined with other conflict resolution alternatives (i.e. EET+STT; EET+RRT; EET+RRT+STT).

Complementing the two generic steps detailed for the development of the conflict resolution alternatives in nodes outside the critical area, the ETT is incorporated in the bundle of elemental conflict solutions. Incorporating the ETT will support the development of a broader range of possible conflict resolution alternatives; thus, an additional step must be considered.

3. ETT: As discussed during the implementation of the early turn to address occupancy conflicts on links within the critical area, due to the robust influence of the elemental conflict solution on the operational circumstances of the disrupted network, the alternative ought to be implemented under specific circumstances:
 - a) The occupancy conflict must take place in a node within the critical area that is not the LtfTS. However, if occupancy conflict takes place in the LtfTS, the measure can only be utilized to generate resolution alternatives and under the condition that exploration of solutions is expanded to the previous node.
 - b) The measure can only be applied to trains involved in single or multi over-occupation conflicts that drive towards the LtfTS.
 - c) The waiting time t_w assigned to the train at the platform track or at the entrance of the node (i.e. end of the link adjacent to the node – at the home signal) in order to solve the current conflict must be larger than the minimum turning time $\min t_{Turn}$.

Under the circumstances detailed above, the early turn, as described in subsection 6.3.6, can be generated as a conflict resolution alternative. Ultimately, all of the concluding observations that have been made for implementing the ETT to solve conflicts on links must also be considered.

11.5.2. Development of Conflict Resolution Alternatives for Infrastructure Availability Conflicts

Given that infrastructure availability conflicts may consider the unavailable infrastructure element as being permanently occupied, the development of their conflict resolution alternatives can acquire similar principles as the overall approach explained for occupancy conflicts (see subsection 6.5.1). Therefore, the development of resolution alternatives for occupancy conflicts detailed in subsection 11.5.1 can be modified to support permanently occupied elements and the handling of one-train conflicts. Furthermore, the existing approach can also be modified to support the second kind of infrastructure availability conflicts (i.e. conflicting entrance sequence to the LtfTS). This subsection derives an approach for the development of resolution alternatives $RS_{C_f}^Y$ to address both kinds of infrastructure availability conflicts C_f identified in the conflict list $L_{I_{S,o}}$ of the PVSCS combination $I_{S,o}$ being fixed.

At the outset, the conflict resolution process relies on the predefined elemental conflict solution alternatives derived in subsection 6.5 for occupancy and infrastructure availability conflicts. As the implementation of the elemental conflict solution measures is foreseen to be performed similarly

to the approach already established for occupancy conflicts, the resolution of infrastructure availability conflicts maintains the distinction between links and nodes. However, for this specific conflict type, the location of the conflicts in correspondence to the disrupted section is not of particular relevance for neither of the infrastructure availability conflict kinds.

The following subtitles provide a detail description of the required modifications to be included in the existing structure, guiding the development of conflict resolution alternatives for occupancy conflicts. The modifications are detailed to address both kinds of infrastructure availability conflicts (i.e. unavailable infrastructural elements and the upholding of the entrance sequence to the LtTS) throughout links and nodes.

Development of Conflict Resolution Alternatives for Unavailable Infrastructural Elements

Addressing the unavailable infrastructural elements entails, including the necessary spatial and temporal modifications to the conflicting trains so that they can support their established PVSCS in the PVSCS combination. These modifications, just as the for occupancy conflicts, are detailed distinguishing between links and nodes. However, since this conflict type cannot be solved by solely exploring temporal alternatives (e.g. STT), the more exhaustive structure advanced to resolve occupancy conflicts in elements within the critical area is utilized regardless of the actual location of infrastructure availability conflicts in the network.

Development of Conflict Resolution Alternatives for Infrastructure Availability on Links

For unavailable track elements on links, the overall approach detailed to address occupancy conflicts in tracks within the critical area requires minor modifications to support the development of the conflict resolution alternatives (see subsection 11.5.1).

Infrastructure availability conflicts cannot be resolved by introducing only temporal modifications in the affected train's schedule. Therefore, from the four generic steps that were initially necessary to address occupancy conflicts on links within the critical area, only two steps are required to develop the conflict resolution alternatives for infrastructure availability conflicts.

1. RRT: An exploration of different routes within the node that guarantee that the affected train is able to fulfill the rest of its PVSCS, is conducted. The rerouting alternatives are explored in the node previous to the link in which the conflict has been identified. Rerouting alternatives that involve tracks across links that are generally utilized in the opposite driving direction must also have the train's route in the subsequent node verified to make sure that it can fulfill its PVSCS.
 - Conflict resolution alternatives that allow the rerouting of the conflict partners without generating any single or multi over-occupation conflicts in the node are directly generated.
 - Alternatives that derive in conflicts within nodes can be refined by combining the RRT with an STT, as detailed in steps 1 and 2, to address occupancy conflicts on links within the critical area. However, these measures must only be applied to the investigated train.
 - Conflict resolution alternatives that still generate new single over-occupation conflicts in the nodes are allowed as long as no conflict-free free option exists.
 - Alternatives that derive multi over-occupation conflicts may be either limited or depending on the computational effort, the steps for conflict resolution in nodes can be conducted.

-
2. ETT: The conflict resolution alternatives that incorporate this measure are limited to the following circumstances:
 - a) The infrastructure availability conflict must take place in a link previous to the LtfTS or between any of the turning stations within the critical area.
 - b) The affected train must be driving towards the LtfTS.
 - c) The waiting time t_w assigned to the train (computed as in step 1, immediately above) in order to solve any follow-up conflict due to the rerouting of the train must be larger than the minimum turning time $\min t_{turn}$.

Under the circumstances detailed above, the early turn, as described in subsection 6.3.6, can be generated as a conflict resolution alternative. This entails securing the entrance of the train to the turning station adjacent to the conflicting link (i.e. at the home signal), assigning a platform track where it can conduct the change in its driving direction and appoint the necessary transition time (i.e. minimum turning time) according to the number of drivers in the train (see subsection 5.4.2). The measure can be combined with the rerouting of the train (RRT) in order to explore the different platform track alternatives that support the turn and allow the train to fulfill its PVSCS.

- Alternatives explored in the previous point that generate follow-up conflicts within other trains in the node can be refined by combining them with step 1 (STT) to address occupancy conflicts on links in order to avoid or limit the acuteness of follow-up conflicts in the respective node.
- Alternatives that engender multi over-occupation conflicts can be immediately discarded or depending on the computational effort available, the steps for conflict resolution in nodes can be conducted.

Development of Conflict Resolution Alternatives for Infrastructure Availability in Nodes

For unavailable elements within nodes, the resolution of infrastructure availability conflicts must follow the established structure of addressing single and multi over-occupation conflicts as described for occupancy conflicts. However, the development of the conflict resolution alternatives merges the approaches for nodes inside and outside of the critical area. This results in a two-step process, supporting the development of conflict resolution alternatives to address infrastructure availability conflicts in nodes.

1. RRT: Different the entrance and existing routes through the node (i.e. this includes changes of the platform tracks) that allow to solve the conflict and guarantee the train to reach the subsequent node in its PVSCS are considered. The exploration of rerouting alternatives also includes the use of tracks within links that are generally utilized in the opposite driving direction, which require an additional verification on the subsequent node. If possible routes in the node have been ascertained, but these engender follow-up conflicts with other trains, they are furthered refined by combining them with a shift in time (STT) and abiding by the framework to handle occupancy conflicts in nodes.
2. ETT: Due to its robust influence on the operational circumstances of the network, this elemental conflict resolution alternative ought to be implemented under the following circumstances:
 - a) The infrastructure availability conflict must take place in a node within the critical area that is not the LtfTS. However, if infrastructure availability takes place in the

LtFtS and no feasible conflict solutions have been able to be developed, the measure may be implemented in the previous node.

- b) The measure can only be implemented to trains that drive towards the LtFtS.
- c) The waiting time t_w assigned to the turning train at the platform track or at the entrance of the node (i.e. end of the link adjacent to the node – at the home signal) in order to solve any follow-up conflict due to the implementation of the RRT must be larger than the minimum turning time $\min t_{turn}$.

Under the circumstances detailed above, the early turn, as described in subsection 6.3.6, can be utilized to develop conflict resolution alternatives to address the conflict. The measure can be combined with the rerouting of the train (RRT) in order to explore the different platform track alternatives that support the turn and allow the train to support and fulfill its PVSCS.

- Alternatives explored in the previous point that generate follow-up conflicts within other trains in the node can be refined by combining them with a shift in time (STT) in order to avoid or limit the acuteness of follow-up conflicts in the respective node.
- Ultimately, any follow-up occupancy conflicts derived by implementing this measure must be conducted, as part of the framework to handle occupancy conflicts in nodes.

Development of Conflict Resolution Alternatives to Uphold the Entrance Sequence to the LtFtS

Addressing infrastructure availability conflicts due to the conflicting entrance sequences to the LtFtS entails introducing the necessary spatial and temporal modifications to the conflicting trains so as to abide with the established sequence u in the combination $I_{S,o}$. The development of conflict resolution alternatives has as its sole objective establishing different alternatives for a train whose projected arrival at the LtFtS generates a conflict with the entrance u in the PVSCS combination $I_{S,o}$ under investigation (see subsection 11.4.1).

The conflict resolution alternatives must ensure that train $T_{l_s,i}^{h-1}$ with an order $(h-1)$ in the sequence u , arrives at the LtFtS before the conflicting train $T_{l_s,j}^h$ with an order h in the sequence u (see subsection 10.5). Thus, the arrival of the conflicting train $T_{l_s,j}^h$ at the LtFtS must be postponed.

The minimum time the conflicting train needs to be postponed $t_{w_{T_{l_s,j}^h}}$ so that that the conflict may be resolved is derived as detailed in equation 11.11. The $t_w^{LtFtS}_{T_{l_s,j}^h}$ is calculated for a projected arrival of the conflicting train at the LtFtS calculated at the moment in time the conflict has been identified (see subsection 11.4.1). Therefore, during the development of the conflict resolution alternatives, any changes in the driving and stopping patterns of the conflicting train and their influence in the journey time must be taken into consideration.

$$t_{Proj.Arr_{T_{l_s,i}^{h-1}}}^{LtFtS} - t_{Proj.Arr_{T_{l_s,j}^h}}^{LtFtS} = t_w^{LtFtS}_{T_{l_s,j}^h}; \text{ where if } \begin{cases} t_w_{T_{l_s,j}^h} \geq 0, \exists \\ t_w_{T_{l_s,j}^h} < 0, \nexists \end{cases} \quad (11.11)$$

Since the conflict location is always located at the LtFtS, the exploration of solutions starts at the entrance of the LtFtS, utilizing the structures established to address the infrastructure availability

conflicts in nodes. For this, the following three generic steps, each focusing on the implementation of a particular conflict solution alternative, are conducted:

1. STT: The entrance to the LfTS is postponed by shifting the conflicting train in time. A waiting time t_w at the end of the link adjacent to the LfTS, at the platform track in the node previous to the LfTS or at any other location, which given the actual operating circumstances, reduces the likelihood to induce a follow-up conflict, is introduced in the train's schedule. The waiting time t_w being introduced to solve the conflict must take into account the changes in the journey time of the affected (if no stop at the chosen location was previously foreseen in the schedule of the affected train).
2. RRT: In order to identify a waiting location for the conflicting train that does not engender follow-up conflicts, different routes throughout the node previous to the LfTS are explored. The explored routes must guarantee that the affected train is able to reach all the nodes established in its PVSCS. The exploration also includes the use of tracks through links normally utilized in the opposite driving direction and that must be additionally verified on the subsequent node.

For the rerouting alternatives, the necessary waiting time t_w as establish in equation 11.11 can be assigned at the platform track or at the end of the adjacent link. However, any potential changes in the journey time due to the modification in the train's route or the stopping patterns must be supported.

If possible routes through the node have been ascertained, but these engender follow-up conflicts with other trains, they are refined by shifting the conflicting train in time. The waiting time appointed to the train by implementing the STT measure must also be taken into account when calculating the necessary waiting time to resolve the conflict.

Ultimately, if any follow-up occupancy conflicts are created within the node due to the rerouting, the framework to handle occupancy conflicts in nodes must be conducted.

3. ETT: Due to the robust influence on the network's operating situation, an early turn conflict ought to be implemented under the following circumstances:
 - a) The waiting time t_w assigned to the train at the platform track in the node previous to the LfTS in order to solve the conflicting entrance sequence, is larger than the minimum turning time $\min t_{Turn}$.

Under the circumstances detailed above, the early turn, as described in subsection 6.3.6, can be generated as a conflict resolution alternative. The measure can be combined with the rerouting of the train (RRT) in order to explore the different platform track alternatives that support the turn and allow the train to support and fulfill its PVSCS.

- Alternatives explored in the previous point that generate follow-up conflicts within other trains in the node can be refined by combining them with an STT in order to avoid or limit the acuteness of follow-up conflicts in the respective node. This shift in time must be considered when calculating the necessary waiting time to solve the conflict.
- Applying the early turn would remove the train from the sequence. This remark is valid for the implementation of an early turn to any potentially queuing train within the critical area, regardless of the conflict being handled.
- Ultimately, any follow-up occupancy conflicts derived by implementing this measure must be handled as part of the framework to solve occupancy conflicts in nodes.

11.5.3. Development of Conflict Resolution Alternatives for Circulation Conflicts

The development of resolution alternatives for circulation conflicts $RS_{C_f}^y$ is also aligned with the fulfillment of the requirements discussed in subsection 11.2. At the outset, due to the nature of the conflict, the alternatives are developed at nodes having as a foundation the elemental conflict solution alternatives for circulation conflicts advanced in subsection 6.5.2. This subsection provides a detailed discussion regarding the development of the conflict resolution alternatives to address circulation conflicts C_f identified in the conflict list $L_{I_{S,o}}$ of the PVSCS combination $I_{S,o}$ as part of the DRP deployment system.

An overview of the elemental conflict solution alternatives for circulation conflicts can be appreciated in figure 6.6. Figure 6.6 contains the five elemental conflict solution alternatives listed below, including the possibility to combine these measures to enhance the overall quality of the resulting conflict resolution alternatives.

- Shifting trains in time - STT (see subsection 6.3.8)
- Rerouting trains – RRT (see subsection 6.3.11)
- Early turning trains – ETT (see subsection 6.3.6)
- Developing an alternative train service – ATS (see subsection 6.3.12)
- Cancellation of a train service – CS (see subsection 6.3.5)
- Combination of alternatives

The ability to combine the elemental conflict solution alternatives has been ascertained during the structuring of their bundle discussed in subsection 6.5. The only limitation is the CS, which can only be implemented when combined with an ATS, as it is linked to the cancellation of train services product of the PVSCS combination (i.e. partial or total cancellation of train services, see subsection 11.4.1 – Identification of Service Conflicts). Therefore, for every train service involved in a circulation conflict, there is the possibility to develop at least eleven conflict resolution alternatives. However, just as with occupancy conflicts, the infrastructural situation at hand can further advance the complexity of the search space.

The development of the conflict resolution alternatives for circulation conflicts is derived following the same principles as for occupancy conflicts. Thereby, the differentiation between the handling of the conflicts inside and outside of the critical area is also utilized to address circulation conflicts. However, since circulation conflicts occur only in nodes, there is no need to differentiate between nodes and links.

The following subtitles detail the development process of the conflict resolution alternatives to address circulation conflicts inside and outside the critical area. The procedures are further detailed to highlight the specific requirements for each of the three kinds of circulation between train services handled by the system: turning, coupling, and decoupling (see subsection 11.4.1).

Development of Conflict Resolution Alternatives for Circulation Conflicts Outside the Critical Area

Outside of the critical area, the development of conflict resolution alternatives for circulation conflicts can consider all five of the above-discussed elemental conflict solution alternatives. However, the combination of these alternatives for circulation conflicts does not follow the same principles as in occupation conflicts. In this case, the specific kind of circulation conflict plays an important role (see subsection 11.4.1). Utilizing the solution approaches discussed for each of the

five elemental conflict solutions alternatives (i.e. STT, RRT, ETT, CS and ATS) detailed in subsection 6.3, a general outline of the elemental conflict solution alternatives employed for the development of the conflict resolution alternatives to solve each of the three kinds of circulation conflicts is detailed below.

- For circulation conflicts taking place throughout the whole network between two or more train services, only three elemental conflict solution alternatives from the bundle are available (i.e. STT; RRT; ETT). These elemental solutions can be combined as per the constraints discussed above.
- For circulation conflicts due to the lack of available vehicle compositions product of the PVSCS combination, only the CS can be applied (see subsection 6.3.5).
- Finally, considering that the additional capacity utilization would contravene the desired transitioning to stable operations, circulation conflicts engendered by positive transitions (e.g. positive turns) can only be found in elements within the critical area. Therefore, just as the ETT in occupancy conflicts, the robust influence of utilizing an ATS on the operational circumstances would limit its applicability and render it relevant only to support the effective transference of the system to stable operations. Therefore, within the dynamic DRP deployment system, utilizing an ATS is not deemed suitable to address circulation conflicts outside the critical area.

The development of the conflict resolution strategies is advanced utilizing the above-detailed elemental conflict solution alternatives and explicitly advanced for each of the three kinds of circulation conflicts handled in the dynamic DRP deployment system (see subsection 11.4.1).

Circulation Conflicts for Turning Services

To address circulation conflicts between a train and the train service in its adjusted circulation plan, the exploration of conflict resolution alternatives can be conducted in the four generic steps detailed below.

1. STT: The train service product of the transition is shifted in time until its departure time from the station satisfies equation 11.4. Thus, the waiting time t_w assigned to the train service product of the transition must be made equal to the projected arrival at the station of the train service before the transition plus the minimum transition time (i.e. minimum turning time $\min t_{turn}$) (see equation 11.4). It must be noted that the minimum turning time is dependent on the number of drivers on the train (see subsection 5.4.2).
2. RRT: Different route options (i.e. including changes of platform tracks) inside of the turning station can be explored to reduce or resolve the circulation conflict. However, the explored routes must guarantee that all train services involved in the transition, as detailed by the circulation plan (i.e. before and after the transition between train services), can support their PVSCS in the PVSCS combination being fixed. If possible routes in the node have been ascertained, but these engender occupancy follow-up conflicts with other trains, they can be refined by implementing utilizing an STT.
 - Conflict resolution alternatives that generate new single over-occupation conflicts in the nodes are allowed since their impact on the operating situation can be immediately assessed during the selection process through the follow-up conflicts (see section 12).

- Alternatives that derive multi over-occupation conflicts can be either limited or depending on the computational effort available, the steps for conflict resolution in nodes can be conducted.
3. ETT: Due to the robust influence of the elemental conflict solution alternative on the operating situation of the disrupted network, it can only be implemented under specific operational circumstances. In the case of circulation conflicts, ETT can be implemented:
- if equation 9.2 is not satisfied (see subsection 9.7.2).

Under the circumstances detailed above, the early turn, as described in subsection 6.3.6, can be generated as a conflict resolution alternative in the turning station before the end station initially foreseen for the conflicting circulation. The measure can be combined with the rerouting of the train (RRT) as detailed in step 2, to explore the different platform track alternatives that support the transition of the train services and allow the involved trains to support and fulfill their PVSCS. If possible routes in the node have been ascertained, but these engender occupancy follow-up conflicts with other trains, they can be refined by shifting the assessed trains in time (STT). Ultimately, alternatives that generate new single or multi over-occupation conflicts must be addressed as part of the framework to handle occupancy conflicts in nodes.

With the PVSCS combination already developed and all the available and potential vehicles accounted during the line-specific conflict identification module (see section 8), the only possibility to address circulation conflicts due to the lack of vehicles is through the cancelling of the conflicting train service. The development of the conflict resolution alternatives to solve this kind of circulation conflicts is conducted independently from the four steps detailed above, in one additional step.

4. CS: The cancellation of the train service must be conducted by taking into consideration the existence of a complete or a partial blockage affecting the network in addition to the affected line's DRP operating concept (see subsection 5.3). This information makes it possible to establish the section of the conflicting train service that needs to be cancelled. Therefore, the CS is applied by recognizing the following operational circumstances:
- If the train service is part of the line's set of reachability conflicts rc_{l_s} , it is cancelled from the disrupted section until the end station detailed in its original schedule.
 - If the train service is included in the line's DRP operating concept, which also foresees a deviation of all train services to overcome the complete blockage, the train service must be cancelled in its entirety, recognizing the route throughout the deviation as described in the DRP operating concept.
 - If the train service is included in the line's DRP operating concept, which also foresees the line being isolated in two different sides, the service is cancelled within the recognized portions of the line as described in the DRP operating concept (i.e. from DRP turning station the closest to the disrupted section to the end turning station the furthest from the disrupted section).

Circulation Conflicts for Coupling or Decoupling Train Services

For the development of conflict resolution alternatives for coupling or decoupling of trains outside the critical area, a similar structure as for turning trains can be maintained. However, specific modifications must be included depending on the type of transition being handled.

At the outset, the transition time to be respected in this case is the respective minimum coupling or decoupling times, depending on the transition being handled. Furthermore, in the case of both coupling or decoupling of train services, an early turn (ETT) provides no operational benefit to solve circulation conflicts with this type of transition. Therefore, it is not considered as an elemental conflict solution strategy.

While circulation conflicts that involve the decoupling of a train service can easily follow the first two generic steps detailed above for the development of conflict resolution alternatives without significant modification, circulation conflicts that involve the coupling of train services require individual attention.

Of particular relevance for the coupling of train services is the order of the vehicle or vehicle compositions involved in the coupling process, which can have a substantial impact on the overall operating situation of the network. If maintaining the order of the resulting vehicle compositions in the train service product of the transition (i.e. coupling) is essential, the arrival of the involved train services involved in the circulation conflict at the station must be observed. Therefore, once the arrival of a train service to the coupling station has been recognized as a risk to the order of the vehicle composition in the train service product of the transition (i.e. it arrives before the other vehicle composition(s)), the train must be shifted in time so that the arrival order at the station is maintained. This requirement must be introduced to the system as a function of its importance for the network's operations and the desired computational effort. If it is deemed essential, it can be addressed similarly as for infrastructure availability conflicts product of conflicting entrance sequences to the LtfTS without the use of an ETT (see subsection 11.5.2).

Development of Conflict Resolution Alternatives for Circulation Conflicts Inside the Critical Area

The complexity behind the development of conflict resolution alternatives to address circulation conflicts can also be adjusted to the location of the conflicts in the disrupted network, as it was the case for occupancy conflicts. Therefore, the development of conflict resolution alternatives within the critical can be generated utilizing a similar structure as the one discussed for nodes located outside the critical area, yet expanded to abide with the requirements discussed in subsection 11.2.

While the general structure can be maintained, its capability to support the disrupted network's transition to stable operations must also be enhanced. Therefore, the above-discussed structure is enhanced to include the development of an alternative train service (ATS). The ATS allows the special handling of train services that consume capacity at stations inside the critical area with already limited capacity (due to a potential queue before the LtfTS). Consequently, the development of conflict resolution alternatives for circulation conflicts in the critical area introduces an additional step (step 5) to the four already discussed in the structure for circulation conflicts outside the critical area.

5. ATS: As discussed in subsection 6.3.12, the measure may be applied in stations within the critical area and in cases where a positive transition between train services is identified (i.e. positive transitions, see subsection 11.4.1). Therefore, alternative train services may be developed as conflict resolution alternatives if the difference between the projected arrival of the train to the transition station and the scheduled departure of the train from the station is larger than the minimum transition time, as detailed in equation 11.12.

$$t_{\text{Scheduled.Dep}}^R S^a - t_{\text{Proj.Arr}}^S S^a > \min t_{\text{Trans}} \quad (11.12)$$

Abiding by the circumstances detailed above, alternative train services can be implemented as described in subsection 6.3.12. Their development would allow the train service to be removed from the critical area before its scheduled departure time.

As discussed in 6.3.12, the measure starts by establishing the beginning and end nodes between which the alternative train service needs to be developed. The starting node is inherently the station where the circulation conflict has been identified. Nevertheless, the end node and the route between these elements must still be identified either by advancing some general principle or utilizing an existing method. In overall, two paths can be followed to conduct the development of the alternative train service:

- Introducing an existing model as the ones discussed in subsection 2.2.3 or 2.3.2. While the implementation of existing approaches would inherently secure the task is completed, they would need to be adapted to deal with the dynamic DRP deployment system.
- The alternative train service can also be developed utilizing existing principles within the dynamic DRP deployment system and incorporating the requirements and overall solution approach discussed in subsection 6.3.12.

A similar approach as the one utilized to frame the system's method can be implemented (see subsection 3.5.2). Therefore, alternative train services can be developed by including right-shift rescheduling principles and guided adjustments on the affected train's PVSCS utilized in the PVSCS combination under investigation. In this way, the alternative train services may be generated supporting both spatial and temporal properties.

The PVSCS of the train service product of the conflicting circulation can be shifted negatively in time to support the immediate departure of the train service from the station while abiding by the minimum transition time. However, it is still necessary to establish the portion of the route in the PVSCS that needs to be negatively shifted in time. Consequently, a general heuristic that explores the spatiotemporal aspects that need to be modified in the PVSCS of the train so as to develop the alternative train service and that can be adjusted to the existing computational effort are established in four general steps.

- First, a special train number must be selected for the development of the alternative train service (see subsection 5.3.2).
- Second, respecting the minimum transition time, the PVSCS of the transition train service being affected by the measure is negatively shifted in time between the starting node (i.e. LtFTS) and the first node outside of the critical area. This implies that the original schedule of the affected train service is utilized as a baseline to project the early removal of the train service from stations within the critical area.
- Third, an exploration of follow-up occupancy conflicts along the negatively shifted route is conducted and combined with further measures to support a much more refined development of the alternatives (i.e. different alternative train services) for the train.

To limit the complexity, only an RRT is utilized on the affected train for the exploration of different routing alternatives across nodes and links. Additionally, an STT can be included to derive a much more detailed exploration of alternatives. The exploration of routing alternatives for the

train is done similarly as in subsection 11.5.1 by limiting the exploration to alternatives that derive in single over-occupation conflicts, and that can be solved by an STT appointed to the affected train. Depending on the computational effort available, multi over-occupation and affecting other trains may also be permitted; however, all conflicts need to be solved within the same step to avoid generating follow-up conflicts that cannot be addressed due to the train's negative shift in time.

Every routing variant within and between nodes, which allows the affected train service to reach all the stations originally foreseen in the train's PVSCS constitute an individual conflict resolution alternative. However, if, until this point, no routing option has been successfully identified, the development of the alternative train service is focused only on the route detailed in the train's PVSCS.

Due to the parallel implementation of the RRT and STT in the development of the alternative train service alternatives, the departure time of the affected train service in every alternative, and at every node affected by the negative shift must be controlled against the departure time of the affected train from the same node detailed in its original PVSCS. If during the development of the alternative train service there are alternatives in which the affected train service is projected to depart from a node after the departure time detailed in its PVSCS for the same node, the development of the alternative train service for that alternative is terminated at the arrival of the train service to such node. This is the case since the original train service can be reinstated from such node. However, if an alternative is terminated before the affected train has even left the LtfTS, the alternative should be eliminated. The alternative is eliminated as it is not able to solve the conflict. If all alternatives have been eliminated, the positive turn of the train is solved by simply permitting the train to wait until its scheduled departure time.

- Fourth, for variants that have reached the first node outside the critical area without being terminated, the exploration of further nodes can be conducted if no platform tracks, where the affected train service may wait for its originally scheduled departure without engendering follow-up multi over-occupation conflicts, has been found. The exploration of further nodes may be conducted until a suitable waiting location at a node has been found or until the departure from a node is projected after the departure time detailed in the train's original PVSCS for the corresponding node.

With the four general steps detailed above, different resolution alternatives utilizing the ATS as an elemental conflict solution alternative can be developed.

11.5.4. Development of Conflict Resolution Alternatives for Service Conflicts

As detailed by the available conflict solution alternatives to address vehicle-specific conflicts (see subsection 6.5.3), addressing the service conflicts $C_f = \{t_{SIQ}^{S_a}, \dots, t_{SIQ}^{S_z}\}$ identified in the conflict list $L_{I_{S,o}}$ for the PVSCS combination $I_{S,o}$ is reduced to the implementation of one single conflict solution alternative (i.e. the transference of the passengers' waiting time - TPW). Therefore,

following the measure's requirements and the overall solution approach detailed in subsection 6.3.13, passengers' waiting time is transferred to the subsequent service in every station where the cancellation of train service has generated a service conflict. This subsection details the overall approach to generate the conflict resolution alternative to address the service conflicts across all stations affected by the identified conflict C_f .

During the identification of service conflicts, it has been explained that the cancellation of a train service can affect more than one station at a time. Therefore, for every cancellation of a train service, it is possible that there is more than one service conflict identified. As discussed in subsection 11.4.1, service conflicts are clustered in a set $C_f = \{t_{SI_Q}^{S_a}, \dots, t_{SI_Q}^{S_z}\}$, which all require to be address at the same time.

As a result, regardless of the number of affected stations by the service conflict and the location of these stations, the development of the conflict resolution alternatives is conducted following the four consecutive steps detailed below:

1. The service conflict across all affected stations are recognized $\{t_{SI_Q}^{S_a}, \dots, t_{SI_Q}^{S_z}\}$.
2. The involved train services in each affected station recognized during the identification of the service conflict $t_{SI_Q}^{S_a}$, namely, prior, subsequent and any train services previously linked to the cancelled train service are incorporated.
3. A link between the cancelled and subsequent train services (i.e. $\overline{Q-R}$) at every affected station is secured (see subsection 6.3.13). This would allow keeping track of the transferred waiting times of passengers between these two services during the resolution of further service conflicts in the CDCR process.
4. The passengers' waiting time t_{pw} at every affected station is computed and transferred to the already identified subsequent train service.

As discussed in subsection 6.3.13, the passengers' waiting time that must be transferred to the subsequent train service R at the affected station S_a is computed by the difference between the projected departure time of the subsequent service $t_{Proj,Dep_R}^{S_a}$ and the timespan covered by the maximum service interval $t_{SI,max_{Q,DRP,l_s,\psi}}$ measured from the departure of the prior train service P from the affected station.

Ultimately, the passengers' waiting time $t_{PW,Q-R}^{S_a}$ to be transferred from the cancelled train service Q to the subsequent trains service R at each of the affected stations S_a can be computed as in equation 11.13.

$$t_{PW,Q-R}^{S_a} = t_{Proj,Dep_R}^{S_a} - (t_{Proj,Dep_P}^{S_a} + t_{SI,max_{Q,DRP,l_s,\psi}}) + \sum t_{PW,O-\overline{Q}}^{S_a} \quad (11.13)$$

Equation 11.13, also takes into consideration all the passengers' waiting time that may have been transferred to the cancelled train service Q at the affected station S_a by any previously linked service O .

11.5.5. Establishing the Severity of the Identified Conflicts

Having detailed the specific approaches for the development of conflict resolution alternatives across each conflict type handled by the dynamic DRP deployment system, it is now possible to establish their severity. Since the establishment of conflict severity allows to support the system's look-ahead capability, it stands as a key component within both the CDCR and the assessment

modules. This subsection details the establishment of the conflict severity Se for every conflict C_f identified in the conflict list $L_{I_s,o}$ and also every follow-up conflicts C_f' product of the projection of a conflict resolution alternative $RS_{C_f}^Y$ on the operating situation (see subsection 11.4.1) .

As discussed in subsection 3.5.2, there are different ways to ascertain the conflict severity regardless of the nature of the conflicts (i.e. follow-up or an already listed conflict). In the case of the dynamic DRP deployment system, as it is founded over the simplified approach introduced by Oetting et al. (2013), the severity is ascertained by means of the establishment of a “probable” conflict resolution alternative to solve the investigated conflict (see subsection 3.6.2 and 11.3). Within the proposed system, the “probable” conflict resolution alternative, may be derived from exploring a range of the conflict resolution alternatives, which may be developed utilizing the approaches detailed in the previous four subsections.

Furthermore, while it is possible to ascertain the severity of all conflicts and utilize it to support the advancement of the look-ahead capability of the system, certain conflict types may be strategically left out of the analysis. Depending on the computational effort available and the implementing field of the system, certain conflict types may become more important than others. To ascertain the relevance of the four different conflict types handled in the system, the system requirements would provide with the necessary insight (see subsection 3.4.2). For example, occupancy conflicts are central for adjusting both the schedule and circulation plans and have a significant influence on the capacity consumption. Therefore, if the requirements of the system what to be upheld, occupancy conflicts play a critical role in any look-ahead capability of the system. Another example may be found by considering service conflicts, as they are the only means within the system that is set to exclusively uphold passengers’ welfare. As the standard approach for the dynamic DRP deployment system, all the conflict types should have their severity established.

As discussed above, the severity of the conflict C_f is established by generating “probable” conflict resolution alternatives $RS_{C_f}^{YSe}$, which must be subsequently assessed so that one can be selected (see section 12). The conflict resolution alternatives for the establishment of the severity $RS_{C_f}^{YSe}$ are developed by utilizing a limited range of elemental conflict solutions and based on the approaches for each of the conflict types handled by the system. Thus, the severity of an identified conflict Se_{C_f} embodies a set of “probable” conflict resolution alternatives $RS_{C_f}^{YSe}$, which must be assessed and selected in later instances. The same is true for follow-up conflicts C_f' ; in this case, the conflicts stand as a projection of the implementation of an already developed conflict resolution alternative $C_f' RS_{C_f}^Y$ and their established severity also consists of a set $Se_{C_f' RS_{C_f}^Y}$ of “probable” conflict resolution alternatives $RS_{C_f' RS_{C_f}^Y}^{YSe}$, which must be later assessed and selected (see section 12).

This subsection details a simplified approach to establish the severity of every conflict type handled by the dynamic DRP deployment system. The simplified methods are described for every conflict type in the following five subtitles.

Severity of Occupancy Conflicts

As has been previously discussed, the establishment of the conflict severity is based on the implementation of a “probable” conflict resolution alternative. Thus, the establishment of the occupancy conflicts’ severity is aligned with the approaches discussed in subsection 11.5.1. In this

subtitle, the necessary means to establish the severity of occupancy conflicts are advanced within the framework of the already detailed development of conflict resolution alternatives.

At the outset, it is essential to mention that more than one approach has been introduced to support the development of conflict resolution alternatives to address occupancy conflicts. The underlying difference between these approaches consists of the development of conflict resolution alternatives to resolve occupancy conflicts in nodes versus conflicts on links and the handling of occupancy conflict as a function of their location in the network, namely, inside or outside the critical area.

Since establishing the conflict severity entails generating “probable” conflict resolution alternatives not to solve the conflict as such, but to acquire information regarding the acuteness of the conflict, the exploration of solution alternatives does not need to be as rigorous as for the actual resolution of the conflict. Additionally, limiting the complexity would also allow acquiring the desired information faster, particularly in cases where several conflict types are being handled simultaneously. Therefore, to simplify the process for the establishment of the severity of occupancy conflicts, the “probable” conflict resolution alternative development processes distinguishes the type of infrastructural elements in which the conflict has been identified. However, the process does not make any distinction regarding its location in the network. Consequently, the establishment of the severity of occupancy conflicts consists of two different approaches: one for conflicts on links and another for conflicts in nodes.

Establishing the Severity of Occupancy Conflicts on Links

For the development of conflict resolution alternatives to tackle occupancy conflicts on links, two different approaches are available: one for links inside the critical area and another for links outside the critical area. Due to its simplicity and capability to provide an overview of the spatiotemporal adjustments required to address occupancy conflict, regardless of the driving direction of the conflict partners, the approach derived for the development of conflict resolution alternatives to solve occupancy conflicts on links outside the critical area is utilized for the establishment of the conflict severity (see subsection 11.5.1).

Overall, the selected approach is constituted by a shift of trains in time (STT) as its elemental conflict solution alternative. As a result, the development of the “probable” conflict resolution alternatives $RS_{C_f}^{Y_{Se}}$ or $RS_{C_f'RS_{C_f}^Y}^{Y_{Se}}$ to establish the severity of occupancy conflicts on links is based on

the approach detailed for the development of conflict resolution alternatives for links outside the critical area (see subsection 11.5.1).

Establishing the Severity of Occupancy Conflicts in Nodes

As with occupancy conflicts on links, there are also two different approaches available for the development of elemental conflict resolution alternatives for occupancy conflicts in nodes (i.e. inside and outside the critical area). However, as discussed in subsection 11.5.1, addressing occupancy conflicts in nodes also requires making a distinction between single and multi over-occupation. Due to the complexity behind multi over-occupation conflicts, single and multi over-occupation conflicts can be considered as two different kinds of conflicts. Therefore, the establishment of the severity of occupancy conflicts in nodes requires the introduction of two different approaches.

In the case of single over-occupation, due to its simplicity and adeptness, the approach detailed to developed conflict resolution alternatives to address occupancy conflicts in nodes outside the

critical area stands as an adept alternative. The approach utilizes the shift of a train in time (STT) and the rerouting of a train (RRT), as its elemental conflict solution alternatives.

As a result, for developing the “probable” conflict resolution alternatives $RS_{C_f}^{Yse}$ or $RS_{C_f'RS_{C_f}}^{Yse}$ to establish the severity of single over-occupation conflicts in nodes, the approach detailed for the development of the conflict resolution alternatives for nodes outside the critical area is utilized (see subsection 11.5.1). Under this approach, the severity would be established through the development of “probable” conflict resolution alternatives that foresee the shift of the conflict partners in time (STT), their rerouting within the node (RRT) and further specifications to account for the local circumstances.

In the case of multi over-occupation, the approach utilized to develop the conflict resolution alternatives to address this conflict kind in nodes outside the critical area is used. The approach is, in principle, similar to the one advanced to resolve single over-occupation conflicts. However, to address multi over-occupation conflicts, the approach foresees the potential handling of trains that are indirectly involved in the conflict (see subsection 11.5.1). Therefore, a special approach must be advanced to support the establishment of the severity of this conflict kind within nodes.

At the outset, the severity of occupancy conflicts with multi over-occupation in nodes is based on the same principles as in the case of single over-occupation; thus, the same framework can be utilized. However, in case that no conflict-free resolution alternatives are generated, the projected handling of indirectly involved trains must also be supported. Therefore, the implementation of elemental conflict solution alternatives on these trains needs to be considered for the subsequent assessment of the “probable” conflict resolution alternatives.

Furthermore, as discussed in subsection 2.2.3 and 11.5.1, it is possible that despite the handling of indirectly involved trains, the exploration of resolution alternatives does not yield a conflict-free solution for all involved trains. In this case, the first approach foresees the removal of at least one train from the multi over-occupation conflict, leaving the rest to be handled in subsequent steps (see subsection 11.5.1). The establishment of the conflict severity must reflect such circumstances; hence, alternative solutions to support this matter must be identified.

One alternative may be the establishment of a fictitious resolution alternative that does not take the interaction with other trains into consideration but at the same time, reflects the degree of the multi over-occupation conflict. Another alternative may consist of changing the understanding of conflict severity to handle this specific kind of occupancy conflict. Finally, it would also be possible to consider a combination of different understandings that support the establishment of the conflict severity.

Changing the understanding behind the conflict severity may potentially be considered as a possibility from the implementation of a “probable” conflict resolution alternative to, for example, the degree in the overlapping of the occupancy times. However, the utilization of another understanding must support the need for a generalized and uninformed establishment of the conflict severity within every single conflict types handled by the system. Consequently, it is not feasible to modify the understanding behind the conflict severity to facilitate the handling of one specific conflict kind. Therefore, the first alternative is utilized to establish the conflict severity, where a fictitious resolution alternative is developed, yet this alternative must reflect the acuteness of the induced operating situation.

As a result, for developing the “probable” conflict resolution alternatives $RS_{C_f}^{Yse}$ or $RS_{C_f'RS_{C_f}^Y}^{Yse}$ to establish the severity of multi over-occupation conflicts in nodes is based on the same principles as in the case of single over-occupation. However, in this case, the following remarks must be considered for the development of the “probable” conflict resolution alternatives:

- i) If no conflict-free resolution alternatives are generated for all involved trains, the projected handling of indirectly involved trains must also be supported. These trains must be considered as directly involved trains for the assessment of the “probable” conflict resolution alternatives.
- ii) If no conflict-free resolution alternatives are generated despite the handling of indirectly involved trains, the resolution alternative, which allows the maximum reduction in the degree of multi over-occupation, is chosen as a baseline. The remaining trains within the over-occupation conflict are provided with a fictitious conflict resolution alternative. This alternative foresees the shifting of the trains in time (STT) without allowing them to be rerouted within the node. Therefore, restricting the solution alternative to the STT would allow to adeptly reflect the severity of the multi over-occupation conflict.

Severity of Infrastructure Availability Conflicts

Considering that the establishment of conflict severity is based on the implementation of a “probable” conflict resolution alternative, the approaches introduced in subsection 11.5.2 would allow ascertaining the severity of infrastructure availability conflicts. This subtitle provides the necessary means to establish the severity of infrastructure availability conflicts within the framework guiding the development of its conflict resolution alternatives.

Overall, infrastructure availability conflicts within the dynamic DRP deployment system distinguish between two conflict kinds, namely, conflicts due to unavailable infrastructural elements and conflicts devised to uphold the entrance sequence to the LtTS (see subsection 11.4.). An approach for establishing the severity of both kinds of infrastructure availability conflicts is advanced within this subtitle.

As with occupancy conflicts, the approach for the development of conflict resolution alternatives distinguishes between the infrastructural element (i.e. node or link) in which the infrastructure availability conflict has been identified. Furthermore, since the inherent focus of one of the conflict kinds is centred around the LtTS, the location of the conflicts within the network are indirectly considered. Therefore, the establishment of the severity of infrastructure availability conflicts consists of three different approaches: one for unavailable infrastructural elements within links, another for unavailable infrastructural elements within nodes and one observing the entrance sequence of trains to the LtTS. These approaches are discussed in detail in the following three subtitles.

Establishing the Severity of Infrastructure Availability Conflicts on Links

Overall, the development of the conflict resolution alternatives to address infrastructure availability conflicts on links relies fundamentally on the rerouting of the train (RRT) and the early turn of the train (ETT). In both cases, the elemental conflict solutions are complemented by the shift of the train in time (STT) so as to better accommodate the actual operating situation.

To further support the establishment of the conflict severity through a simplified and generalized approach, the elemental conflict solution alternatives that induce further follow-up conflicts are restricted. Since the early turn of the train (ETT) has a substantial influence on the robustness of the network (see subsection 6.3.6), the severity of the conflict is established only through an implementation of the rerouting of the train (RRT) and its shift in time (STT).

As a result, for developing the “probable” conflict resolution alternatives $RS_{C_f}^{Yse}$ or $RS_{C_f'RS_{C_f}^Y}^{Yse}$ to establish the severity of the conflicts addressed in this subtitle, the approach detailing the development of conflict resolution alternatives for infrastructure availability on links is utilized (see subsection 11.5.2). From the detailed approach, only *Step 1* is considered. Ultimately, under this approach, the severity would be established through the development of “probable” conflict resolution alternatives that foresee the shift of the train in time, its rerouting and further specification to account for the local operating circumstances.

Establishing the Severity of Infrastructure Availability Conflicts in Nodes

Overall, the development of the conflict resolution alternatives to address infrastructure availability conflicts in nodes relies on the same elemental conflict solution alternatives to the approach detailed for addressing conflicts on links.

As a result, for developing the “probable” conflict resolution alternatives $RS_{C_f}^{Yse}$ or $RS_{C_f'RS_{C_f}^Y}^{Yse}$ to establish the severity of the infrastructure availability conflicts addressed in this subtitle, the approach detailing the development of conflict resolution alternatives for infrastructure availability in nodes is utilized (see subsection 11.5.2). From the detailed approach, only *step 1* is considered. The second step foresees the early turning of the train (ETT), and it is left aside as it introduces substantial influence on the robustness of the network (see subsection 6.3.6). Ultimately, under this approach, the severity would be established through the development of “probable” conflict resolution alternatives that foresee the shift of the train in time, its rerouting and further specification to account for the local operating circumstances.

Establishing the Severity of Infrastructure Availability Conflicts to Support the Entrance Sequence to the LtTTS

In overall, the development of the conflict resolution alternatives to address infrastructure availability conflicts to uphold the entrance sequence of queuing trains to the LtTTS, entails as elemental conflict solution alternatives: the shift of the train in time (STT), the rerouting of the train (RRT) and the early turn of the train (ETT).

As argued in the previous approaches, the elemental conflict solution alternatives that induce further follow-up conflicts are restricted. Therefore, to establish the severity of the conflict handled in this subtitle, the approach is limited to the implementation of the rerouting of the train (RRT) and its shift in time (STT).

As a result, for developing the “probable” conflict resolution alternatives $RS_{C_f}^{Yse}$ or $RS_{C_f'RS_{C_f}^Y}^{Yse}$ to establish the severity of the conflicts addressed in this subtitle, the approach detailing the development of conflict resolution alternatives to uphold the entrance sequence to the LtTTS is utilized (see subsection 11.5.2). From the detailed approach, only *Step 1 and Step 2* are considered. Ultimately, under this approach, the severity would be established through the development of

“probable” conflict resolution alternatives that foresee the shift of the train in time, its rerouting and further specifications to account for the local operating circumstances.

Severity of Circulation Conflicts

As with the previous conflict types, the establishment of circulation conflicts’ severity is founded over the approaches supporting the development of its conflict resolution alternatives (see subsection 11.5.3). This subsection provides the necessary means to establish the severity of circulation conflicts as part of the framework guiding the development of its conflict resolution alternatives.

Overall, the dynamic DRP deployment system handled a specific kind of circulation conflict in addition to the standard circulation conflicts (see subsection 2.2.3). The additional circulation conflict supports the identification of positive turns during the transition to stable operations in stations within the critical area (see subsection 11.4.). This subtitle provides an approach for the establishment of the severity of all circulation conflicts handled by the system.

Since circulation conflicts only take place within nodes, it is not necessary to advance distinct approaches as for previous conflicts types. Therefore, the severity of circulation conflicts is established under one single approach, which counts with lineaments to account for the positive turns.

The development of conflict resolution alternatives to address circulation conflicts involves six elemental conflict solution alternatives. The elemental conflict solution alternatives are: the shift of trains in time (STT), the rerouting of a train (RRT), the early turn of a train (ETT), the cancellation of train services (CS) and the development of an alternative train service (ATS).

As argued in the previous approaches, the elemental conflict solution alternatives that induce further follow-up conflicts are restricted. Therefore, to establish the severity of circulation conflicts, the approach is limited to the implementation of a shift of the train in time (STT) and the rerouting of the train (RRT). In the case of circulation conflicts due to positive turns, since the development of an alternative train service (ATS) is restricted, the necessary waiting time until the train’s scheduled departure must be accounted as the “probable” conflict resolution alternative (see subsection 11.5.3).

As a result, for developing the “probable” conflict resolution alternatives $RS_{C_f}^{Yse}$ or $RS_{C_f'RS_{C_f}^Y}^{Yse}$ to establish the severity of circulation conflicts, the approach detailing the development of its conflict resolution alternatives for every transition type handled by the system is utilized (see subsection 11.5.3). From the detailed approach, only *Step 1* and *Step 2* are considered. The steps are restricted to foresee the combination of only the two elemental conflict solution alternatives, namely, an STT and RRT. Ultimately, under this approach, the severity would be established through the development of “probable” conflict resolution alternatives that foresee the shift of the train in time, its rerouting and further specifications to account for the local operating circumstances and the transition type (i.e. turning, coupling and decoupling).

Severity of Service Conflicts

As with the previous conflict types, establishing the severity of service conflicts is founded over the approaches that have already been described for the development of its conflict resolution alternatives (see subsection 11.5.4). This subsection provides the necessary means to establish the

severity of service conflicts as part of the already existing framework guiding the development of its conflict resolution alternatives.

Overall, as discussed in subsection 11.4.1, service conflicts are identified across every station that has been affected by the cancellation of a train service, and the resulting conflicts are clustered together. Additionally, service conflicts are solved through the transference of the passengers' waiting time to a subsequent service within every affected station (TPW).

As a result, for developing the “probable” conflict resolution alternatives $RS_{C_f}^{Yse}$ or $RS_{C_f'RS_{C_f}^Y}^{Yse}$ to establish the severity of service conflicts, the approach detailing the development of its conflict resolution alternative is utilized (see subsection 11.5.4). From the detailed approach, every step in the process must be considered. Ultimately, the severity of service conflicts would be established through the development of “probable” conflict resolution alternatives that foresee the transference of the passengers' waiting time at every station where a service conflict has been identified.

11.5.6. Summary

This section has detailed the development of conflict resolution alternatives for the conflicts identified across all four vehicle-specific conflict types handled within the dynamic DRP deployment system. The simple and scalable approach presented by Oetting et al. 2011, has been utilized as the basis for the structure used to develop conflict resolution alternatives. This approach, which focuses solely on the handling of occupancy conflicts, has provided the logical framework necessary to advance the respective processes for all four vehicle-specific conflict types. Additionally, the clear distinction between the handling of conflicts in line and node elements, and between single and multi over-occupation conflicts for occupancy conflicts supported by the existing approach was of critical importance for deriving the specific processes within this subsection.

Notwithstanding, a wide range of different and new approaches have been developed to allow the development of resolution alternatives for different conflict types, thus supporting the fixing of the PVSCS combinations under consideration. In this regard, the approaches presented in this subsection make a distinction between conflicts that transpired both inside and outside of the critical area. Since conflicts in the critical area have a higher potential of affecting the whole network, a much comprehensive development of conflict resolution alternatives was required within this area. The distinction between handling of conflicts inside and outside the critical also allowed the development of conflict resolution alternatives to focus on the computational effort. Additionally, the adjustment of the computational effort has been highlighted throughout the structuring processes.

Furthermore, the proposed structured approach also benefited from the incorporation of a broader range of elemental conflict solution alternatives and their combinatorial possibilities as detailed in subsection 6.5. Ultimately, unique approaches have been advanced to complement the handling of exiting conflicts (e.g. conflicting entrance sequences to the LtfTS as part of infrastructure availability conflicts) as well as supporting the systems ability to address entirely new conflicts (e.g. service conflicts) to accommodate specific aspects of the disruption-management addressed by the system and support its requirements (see subsection 3.4.2).

Finally, this subsection also established a concrete approach to establish the conflict severity for every conflict type handled by the dynamic DRP deployment system. However, as discussed in subsection 11.5.5, depending on the computational effort, the specific conflict types selected to support the look-ahead property can be specially selected.

With the automatic development of the conflict resolution alternatives, their systematic assessment and selection, as depicted in figure 11.1, can now be conducted.

11.6. Closing Remarks

This section sets to explain the development of conflict resolution alternatives at the vehicle-specific level towards enabling PVSCS combinations to become conflict-free schedules. After identifying the specific requirements and limitations to be imposed to the module as part of the overall dynamic DRP deployment system, a structured approach based on pre-existing models has been successfully derived.

The structured approach derived in this section supports the four essential tasks of an automatic and heuristic CDCR process (see subsection 2.2.3), namely, the identification, classification, sorting, and development of resolution alternatives. At its core, the proposed approach entails the automatic identification and resolution of conflicts by means of the implementation of predefined vehicle-specific elemental conflict solutions (see also section 6) and a communication with the assessment module (section 12).

Overall, the vehicle-specific CDCR process foreseen as part of the system's general approach (see subsections 3.5.2 and 3.5.3) has been successfully derived and explained throughout this section. The detailed automatic vehicle-specific CDCR process has the capability to fix any PVSCS combination until it is conflict-free, which ultimately allows deriving the strived conflict-free schedules. The proposed CDCR process also supports incorporating the constraints established by previous processes supported in the system, namely, the Tabu Search algorithm, which allows upholding the quality and practical relevance of the solutions. Finally, a robust approach supporting a look-ahead property by means of the identification of follow-up conflicts and the establishment of the conflict severity has also been successfully included in the CDCR process proposed in this section.

The proposed automatic CDCR process handles all four vehicle-specific conflict-types supported by the dynamic DRP deployment system, as established by its requirements. Compared to similar approaches (e.g. Oetting et al. 2013), the processes detailed within this section are set to cover a broader range of different conflict types; namely, occupancy, infrastructure availability, circulation and service conflicts (see subsection 3.7.2). Additionally, the approach details a structure that can be adjusted in line with the situational complexity (i.e. inside and outside the critical area) and available computational effort. The automatic development of a series of resolution alternatives has been made possible through the incorporation of existing (e.g. Oetting et al. 2011) and original processes that allow the handling of different conflict types while acknowledging their relevance for transitioning the disrupted network to stable operations.

Throughout this section the elemental conflict solution alternatives detailed in section 6.5 and their combination are described step-by-step, supporting their implementation within the framework of the proposed approach. Depending on the implementation requirements, any of the considered elemental conflict solution strategies may be altered or removed from its respective bundle. The implementation of these solutions has been carefully supported and guided by

approaches and heuristics for the effective and efficient development of a wide range of resolution alternatives. The effectiveness of the processes has been further enhanced by ensuring that the development of conflict resolution alternatives can be easily adjusted to match the desired quality of the overall solutions as well as the computational effort available (see subsection 11.5).

The following section is in charge of assessing every conflict resolution alternative developed to address the conflicts identified for the PVSCS combination under consideration. The assessment allows the CDCR to determine the best conflict resolution alternative for every identified conflict and systematically, derive a conflict-free schedule with a fitness value that can be returned to the PVSCS combination assembly module in section 10 (see figures 10.5 and 10.10).

12. Assessment of Conflict Resolution Alternatives and Fixed PVSCS Combinations

12.1. Introduction

The assessment module supports the capability of the CDCR process detailed in section 11 to assess and choose a conflict resolution amongst all alternatives which have been developed to address an identified conflict in the conflict list of a PVSCS combination under investigation. Additionally, once the CDCR process has resolved every identified conflict, the module also supports the capability to assess the resulting fitness of the conflict-free PVSCS combination under investigation and return it to the respective algorithm detailed in section 10.

As discussed in subsection 3.5.2, the module is of central relevance as it supports the system's general approach in two ways. On the one hand, it allows the required CDCR process to achieve its objective of fixing the PVSCS combinations (i.e. resolving all conflicts until they are conflict-free), which simultaneously permits the dynamic DRP deployment system to attain its specific objective (see subsection 3.2.2). On the other hand, the assessment process constitutes the main bridge between the different modules in the system as it transforms the results from the CDCR process, refines them and provides the metaheuristic algorithms guiding the arrangement of the PVSCS combinations with the necessary information to guide the exploration of the search space (i.e. fitness of the PVSCS combinations) (see figures 10.5 and 10.10). Consequently, considering the distinction between different operational levels guiding the dynamic DRP deployment system's overall approach (see subsection 3.5.2 and 3.5.3), the assessment module is the final step, taking into consideration all the disruption-management actions handled from module 8 to 11 in order to address the disrupted situation and match the selected DRP operating concept with the actual disruption.

The assessment module receives two different types of inputs from previous modules (see figure 11.1). The first type of input is constituted by a set of conflict resolution alternatives from the CDCR process, which includes the set of "probable" conflict resolution alternatives for the establishment of the conflict severity of all the identified conflicts and follow-up conflicts. Additionally, the module also receives the resulting conflict-free PVSCS combination, once all the vehicle-specific conflicts have been resolved (i.e. fixed PVSCS combination). In overall, as established in subsection 3.5.2 and depicted in figure 3.1, the assessment module has as its main objective the automatic evaluation of every conflict resolution alternative developed by the CDCR process and establishing the fitness of the resulting conflict-free PVSCS combinations (i.e. fixed).

The assessment module must be able to automatically assess every conflict resolution alternative generated by the CDCR process while supporting the look-ahead capabilities, as discussed in the system requirements (see subsection 3.4.2). The look-ahead capabilities are handled by considering the severity of the conflicts that must be supported within the assessment module, as established in section 11. Furthermore, as discussed in subsection 3.5.2, the assessment module must be able to evaluate a conflict resolution alternative regardless of the conflict, which is being solved and establish a general evaluation function that allows considering the induced effect on the operating situation. Additionally, as foreseen in subsection 3.5.2 (see figure 3.1), the assessment must be able to summarize the effects of every conflict resolution alternative utilized in the CDCR process to fix the PVSCS combination under investigation and ascertain the fitness of the conflict-free PVSCS combination so that it can be returned to the metaheuristic algorithms (see section 10).

Moreover, the conflict resolution alternatives at both the line and vehicle-specific operational levels have been developed utilizing a set of elemental conflict solutions (see section 9, section 11 and section 6). Every elemental conflict solution alternative that has been utilized to develop every train's PVSCS and the conflict resolution alternatives within the CDCR process has been evaluated by means of a structured approach discussed in section 6 (see subsections 6.6.2 and 6.3). The structured evaluation included the identification of the determining variables to evaluate the effects of every elemental conflict solution on the operating situation of a disrupted commuter railway network. The assessment module should utilize the already identified determining variables to establish the required evaluating function.

Throughout this section, a structured approach that allows the module to fulfill its general objectives as part of the dynamic DRP deployment system is derived. An evaluation function is first established, which supports an evaluation not only of the conflict resolution alternatives developed in the CDCR process but also the PVSCS combinations as a whole. With the evaluation function at the core of the assessment module, its interplay with the already existing approaches guiding the development of conflict resolution alternatives in section 11 and the PVSCS combinations in section 10 is safeguarded.

In the following subsections, the module supporting the assessment of both the conflict resolution alternatives developed by the CDCR process in section 11 and the PVSCS combinations, are derived and described with precise detail. At the outset, subsection 12.2 provides a detailed discussion on the context and the arrangement of a structured approach to conduct the assessment within the lineaments detailed in subsection 3.5.2. Subsection 12.2 merges the determining variables of every elemental conflict solution alternative utilized in the system (identified in subsection 6.3) with existing assessment approaches discussed in subsection 2.2.3, to lay the groundwork and establish the evaluation function and the module's structured approach. Later, subsection 12.3 provides a thorough discussion of the assessment structure behind every determining variable that constitutes the evaluation function and detailing the particular operational attributes and decision units. Thereafter, subsection 12.4 discusses refines and further details the process to ascertain the fitness of the PVSCS combinations, which are based on the structured approach introduced in 12.2.

12.2. Structured Approach for the Assessment of the Conflict Resolution Alternatives

The assessment module is the concluding step within both the CDCR process and the assembly of PVSCS combinations. On the one hand, the module supports the evaluation of the developed conflict resolution alternatives, as discussed in subsection 11.5 and detailed in figure 11.1. On the other hand, it also supports the ability to evaluate the fitness of the PVSCS combinations generated in section 10. Therefore, the approach guiding the assessment module within the dynamic DRP deployment system is structured in such way that it is not only aligned with the CDCR process (see section 11) but also acquiring and conveying the necessary information to the metaheuristic algorithms in charge of assembling the PVSCS combinations and exploring the optimal entrance sequence of potentially queuing trains to the LfTS (see section 10.5 and 10.6). This subsection derives a structured approach that supports conducting the assessment of both the conflict resolution alternatives developed by the CDCR process, and ultimately, the fitness of the conflict-free PVSCS combinations, abiding by the overall system's requirements.

As discussed in subsection 3.5.2, to conduct the automatic evaluation of the conflict resolution alternatives developed by the CDCR process in section 11 and the fitness of an already conflict-

free PVSCS combination, an evaluation function must be established. Therefore, before deriving this module's structured approach, the evaluation function must be positively established.

As described in subsection 3.5.2, the evaluation function is envisioned as a modular arrangement constituted by a series of determining variables *DV*. A modular arrangement would allow a flexible configuration of the determining variables which are to be weighed and normalized so that they can be easily added, removed and compared with one another (see subsection 3.5.2). As a result, so that all the effects of the assessed conflict resolution alternative or conflict-free PVSCS combination can be added together, the evaluation function would be constituted by a series of determining variable that are evaluated utilizing the same point of view (e.g. temporally) and weighted so that it may be immediately combined with the evaluated effects from the other determining variables in the function. By structuring the evaluation function in this way, the assessment approach may adeptly support the automatic selection of the conflict resolution alternatives developed in the CDCR process and, ultimately, the establishment of every PVSCS combination's fitness.

The determining variables for every elemental conflict solution utilized across both line-specific and vehicle-specific operational levels have already been established throughout section 6.3. The determining variables have been established by contemplating the solution approach of every elemental conflict solution alternative across both of the operational levels (i.e. line-specific and vehicle-specific) handled within the dynamic DRP deployment system (see subsection 6.3). As explained by the structured evaluation approach introduced in subsection 6.2.2, a close consideration of the solution approach allows grasping the spatiotemporal effects on the operations and further attributes that become relevant for both the operations and passengers' transport matters. The structured evaluation approach detailed in subsection 6.2.2 categorized every determining variable within three different types of influences, namely, temporal, spatial, look-ahead, and other measure-specific effects that influence the operations of the railway system or the disruption-management (i.e. Malus).

From the fourteen elemental conflict solution alternatives introduced at the line and vehicle-specific operational levels and evaluated by the approach introduced in subsection 6.2.2, a total of ten determining variables have been identified. The ten determining variables listed below have been established by gathering the determining variables for every elemental conflict solution alternative evaluated along with subsection 6.3 and summarizing them in the list presented below.

- Train delays (Temporal)
- Changes of platform tracks (Spatial)
- Changes of routes (Spatial)
- Changes of scheduled turning stations (Spatial)
- Number of cancelled stops (Malus)
- Train Service Cancellations (Malus)
- End-of-day imbalances (Malus)
- Follow-up occupancy conflicts (Look-Ahead)
- Follow-up circulation conflicts (Look-Ahead)
- Follow-up service conflicts (Look-Ahead)

As established in the systems general approach (see subsection 3.5.2), the conflict resolution alternatives developed to resolve conflicts across both operational levels, namely, every PVSCS combination at the line-specific and the set of conflict resolution alternatives at the vehicle-specific

level, have been developed utilizing the elemental conflict solutions evaluated in subsection 6.3. Therefore, it is possible to ascertain that the ten determining variables listed above cover all the effects that may have been induced throughout the assembly and fixing of the generated PVSCS combinations and ultimately contained within the resulting conflict-free PVSCS combination. Accordingly, the ten determining variables lay the groundwork for structuring the evaluation function required by the system's overall approach.

From lineaments detailing the structuring of the evaluation function discussed above, the ten determining variables recognized in subsection 6.3 must be assessed from the same point of view. This entails utilizing the same decision units to describe their effects on the operating situation. During the evaluation throughout subsection 6.3, four types of influences have been established, namely, temporal, spatial, look-ahead, and other measure-specific effects that influence the operations (see subsection 6.2.2). In existing approaches (see subsection 2.2 and 2.3), the determining variables are mainly assessed from a temporal point of view given that delay is utilized as an alternative to assess the quality of service. Therefore, the ten determining variables may be distinguished in two different clusters. Firstly, there are determining variables that may be intrinsically expressed temporally, namely, the induced train delay. The rest are determining variables which may require establishing an operational attribute that can either be temporally quantifiable or calibrated to be expressed as a time equivalent attribute. Therefore, each of the ten determining variables in the list requires an evaluation approach to support the handling of its effects as outlined by the strived evaluation function's structure. Nonetheless, it must be considered that there are existing approaches that support the assessment of some of the ten determining variables in the list.

Having introduced the potential determining variables, the evaluation function, and in due course, the overall approach guiding the assessment module can be derived. This subsection first acknowledges the most relevant approaches presented in subsection 2.2.3, which would allow establishing an approach for the handling of the determining variables identified in subsection 6.3. An overview of these approaches is discussed in subsection 12.2.1. Ultimately, subsection 12.2.2 discusses and derives the evaluation function and the structured approach for conducting the assessment on both the conflict resolution alternatives developed in section 11 as well as the fitness of the PVSCS combination to be returned to the respective metaheuristic algorithm in section 10.

12.2.1. Existing Assessment Approaches

In subsection 2.2.3, existing assessment techniques for heuristic CDCR process have been discussed. The most relevant of these approaches are proposed by Oetting et al. (2011), Oetting et al. (2013), DB Netz (2017). This subsection provides a brief discussion on the existing approaches for the structuring of this module's evaluation function.

As it has been discussed in subsection 2.2.3, the three approaches mentioned above put forward similar evaluation frameworks, establishing modular evaluation functions within the context of heuristic as well as automatic CDCR processes. The evaluation functions within the existing approaches are established in overall by the handling of three determining variables:

- *Expected relative-time change* of all directly involved trains in the conflict resolution alternative, which focuses on the induced changes on every trains' delay.
- *Change in the projected operating situation*, which allows accounting for the fluctuations in the operating situation induced by a prospective implementation of a conflict resolution

alternative. This determining variable is focused on the resulting follow-up conflicts, providing the assessment with a look-ahead capability.

- *Changes of platform track*, which is mainly focused on its effects on passengers' welfare.

The first determining variable, namely, changes in the train's projected relative-time, support in one single determining variable, the evaluation of all the spatiotemporal effects induced by conflict resolution alternatives on the projected relative-time (i.e. the amount of delay, see subsection 3.6.2) of all directly involved trains. These changes are weighted with respect to the train's actual delay and priority respective to its model train (see subsection 2.2.3). The approach introduced in DB Netz (2017), provides a very detailed account to conduct the weighting of the expected relative-time change of every involved train utilizing a weighting function, which has been described in subsection 2.2.3.

The second determining variable, namely, changes in the projected operating situation, has been partly introduced and discussed in section 11. The determining variable is founded over the approach proposed by Oetting et al. (2013), which relies on the severity of conflicts to evaluate the changes in the projected operating situation induced by the potential implementation of a conflict resolution alternative (see subsection 2.2.3). As discussed in subsection 11.5.5, the severity of conflicts is ascertained through the implementation of a "probable" conflict resolution alternative; therefore, it allows a temporal evaluation of the generated follow-up conflicts, enhancing the assessment and selection of the developed conflict resolution alternatives.

The third and last determining variable, namely, changes in the platform track, allows considering the spatial modifications induced by the conflict resolution alternatives on the passengers' welfare and include them in the evaluation. The approach introduced in DB Netz (2017), handles this non-temporal attribute through calibrated penalty values (see subsection 2.2.3). The penalty values are calibrated so that they may be expressed temporally and differentiate between the model train's priority as well as a change of the platform track between entirely different platforms versus a simple change to a different edge of the same platform.

Having an overview of the existing approaches that support an evaluation within the context of an automatic CDCR process, the evaluation of the determining variables identified during the establishment of the elemental conflict solution alternatives can be derived much thoroughly. A thorough consideration would permit to build on existing knowledge as much as possible. This implies establishing which of the determining variables may be evaluated through existing approaches, which need to be adjusted, and which require an entirely new evaluation approach.

The ten determining variables derived throughout subsection 6.3 are arranged in table 12.1 according to the type of influence recognized by the approach introduced in subsection 6.2.2. Table 12.1 details for every identified determining variable, the existing evaluation approaches that may support their evaluation and the utilized decision units to express their effects on the operating situation. Furthermore, in table 12.1, the dynamic DRP deployment system is also acknowledged as a potential framework that may be utilized to support the evaluation of an identified determining variable (e.g. handling of service conflicts).

Table 12.1 Summary of the handling of the ten determining variables identified from the examination of the predefined elemental conflict solution alternatives across both line-specific and vehicle-specific operational levels in correspondence to existing approaches (by author)

Type	Determining Variables	Existing Evaluation Approaches		Resulting Determining Variable
		Approach	Decision Units	
Temporal	Train delay	Establish the expected relative-time change from a projected implementation of conflict resolution alternative	Expected relative-time changes	Expected relative-time changes
Spatial	Changes in routes			
Spatial	Changes of platform tracks	Penalize the changes of platform tracks considering the effects on its users	General time equivalent penalty value/ To be established	Changes of platform tracks
Spatial	Changes of turning stations	To be established		Changes of turning stations
Malus	End-of-day imbalance	To be established		End-of-day imbalances
Malus	Train service cancellation	To be established - (framework provided by the handling of service conflicts as part of the dynamic DRP deployment system)		Cancelled train services
Malus	Number of cancelled stops			
Look-Ahead	Follow-up occupancy conflicts	Evaluate the changes in the projected operating situation induced by the projected implementation of a conflict resolution alternative	Severity and number of identified and follow-up conflicts (Expressed in Min. or Sec.)	Changes in the projected operating situation
Look-Ahead	Follow-up circulation conflicts			
Look-Ahead	Follow-up service conflicts			

In the last column of table 12.1, the ten determining variables initially identified throughout subsection 6.3, have been clustered and reduced into six modular elements. The resulting determining variables detailed in the last column of table 12.1 have been derived by taking into account the way in which the existing evaluation approaches allow to evaluate the effects of conflict resolution alternatives on the operating situation. In the same way, the lack of existing evaluation approaches to evaluate the effects of certain determining variables (e.g. end-of-day imbalance) has also been identified. The clustering of the ten initial determining variables identified throughout subsection 6.3 into the six resulting determining variables displayed in the last column of table 12.1 has been conducted as follows:

- Firstly, train delays and changes in routes can be clustered together and handled as foreseen by the expected relative-time change as supported by existing approaches (e.g. Oetting et al. 2013).
- Second, as discussed in subsection 11.3, the handling of the follow-up conflicts as the system's required look-ahead capability is addressed by contemplating the change in the projected operating situation.
- Third, the influence introduced by the changes of platform tracks on the users is handled individually as in the existing approaches (e.g. Oetting et al. 2013).
- Fourth, the framework built in the dynamic DRP deployment system to handle service conflicts within the context of planned disruption-management makes it possible to address any effect that involves the cancellation of any train service. Since service conflicts

are identified and solved for every single station affected by a cancellation of a train service from a passengers' perspective (see subsections 6.3.13 and 11.5.4), the evaluation of a train service cancellation and the number of cancelled stops can be evaluated together in one determining variable.

- Fifth, two determining variables, namely, the changes of turning stations and the end-of-day imbalances, do not count with an existing framework that would support their assessment as part of an automatic CDCR process or fulfill the requirements of the dynamic DRP deployment system (see subsection 3.4.2). Therefore, a completely new approach must be advanced to support their handling within the assessment module.

The six resulting determining variables are of central importance for the establishment of the assessment module as they hold the potential to establish the module's evaluation function as foreseen in the general approach (see subsection 3.5.2 and 12.1).

Having identified relevant existing approaches and established potential determining variables that may constitute the modules within the evaluation function, the module's structured approach can be derived.

12.2.2. Structured Approach for the Assessment

The structured approach introduced within this module is set to provide a framework to support the assessment of the conflict resolution alternatives developed by the CDCR process in section 11, and the establishment of every PVSCS combination's fitness (see section 10). This subsection provides an overview of the module's resulting evaluation function derived from the existing approaches discussed in subsection 12.2.1 and an assessment process aligned with the dynamic DRP deployment system requirements (see subsection 3.4.2).

Due to the nature of the dynamic DRP deployment system's overall approach, there are two key capabilities to be supported by this module's structured approach. On the one hand, the assessment module must establish processes for evaluating the conflict resolution alternatives developed within the CDCR process, and on the other, it must support ascertaining the fitness of the fixed PVSCS combination.

Following a logical order, the structured approach starts with the assessment of the conflict resolution alternatives developed in the CDCR process, as the means to support fixing the PVSCS combinations. Therefore, this first portion of the assessment focuses on evaluating the overall effect on the operating situation of every conflict resolution alternative developed to address conflicts on the PVSCS combination's conflict list. Its explicit purpose is supporting the automatic CDCR process by assessing the effect of every conflict resolution alternative on the operating situation, thus, supporting the selection of one alternative amongst all conflict resolution alternatives that may be developed to resolve the identified conflict (see subsection 11.5).

The approach then conducts a final evaluation by gathering the changes introduced during the fixing process and includes the assessment of further operational attributes to establish the fitness of the whole PVSCS combination. The complementary operational attributes have not been handled in the CDCR process, and result from particular line-specific elemental conflict solution alternatives that have been utilized to develop every trains' PVSCS included the combination. Once established, the fitness of the whole PVSCS combination can be returned to its respective process, either to the Genetic algorithm detailed in subsection 10.6 or the Tabu Search algorithm specified in subsection 10.5.

As discussed in subsection 12.2.1, each of the six determining variables DV has the potential to represent a module within the resulting evaluation function. As established through table 12.1, every DV focuses on a specific effect on the operating situation of the disrupted network. However, since the assessment module has the objective to perform an automatic assessment of every conflict resolution alternative developed by the CDCR process and later establish the fitness of the resulting conflict-free PVSCS combinations, the evaluation function must be able to distinguish between these two general tasks. Therefore, the evaluation function is established according to the necessary tasks that must be fulfilled throughout the assessment.

The first portion of the assessment is built over an evaluation function that allows assessing the conflict resolution alternatives as part of the CDCR process. From the six available determining variables discussed in subsection 12.2.1 and under consideration of the system's general approach (see subsection 3.5.2 and figure 3.1), four parameters may be singled out. The four parameters are singled out on the basis of their ability to cover the assessment of the conflict resolution alternatives developed by the vehicle-specific CDCR process utilizing vehicle-specific elemental conflict solutions (see subsection 6.5). The first determining variable (DV_1) focuses on assessing the expected relative-time change induced by the conflict resolution alternative on all directly involved trains. The second determining variable (DV_2) assesses the change in the projected operating situation induced by the prospective implementation of the conflict resolution alternative. The third determining variable (DV_3) concentrates on assessing the changes on the platform tracks of all directly involved trains induced by the conflict resolution alternative. Finally, the fourth determining variable (DV_4) takes into consideration any train service cancellation that may be introduced by a conflict resolution alternative. However, the process for the handling of the service conflicts as discussed in section 11, demands the determining variable to assess both the induced train service cancellations product of a conflict resolution alternative and train service cancellations product of the line-specific elemental conflict solution alternatives utilized to develop the PVSCS combination (see subsection 11.5 and 11.4). Finally, the two remaining parameters are left to be included in the second portion of the assessment. This is the case since the assessment of these parameters would benefit from all changes introduced in the PVSCS combination during the fixing process and are not critical during the vehicle-specific CDCR process.

With the four determining variables singled out, the effect R of every conflict resolution alternative $RS_{C_f}^Y$ developed to address a conflict C_f in the list $L_{C_{1s,o}}$ may be ascertained. As a result, the evaluation function to be utilized within the first portion of the assessment is a generalized version of equation 2.8 introduced in subsection 2.2.3., where the effect of a conflict resolution alternative $R(RS_{C_f}^Y)$ results (see equation 12.1) from simply adding the four weighted w_i determining variables DV_i , as foreseen by the system's general approach (see subsection 3.5.2).

$$R(RS_{C_f}^Y) = \sum_{i=1}^{i=4} w_i * DV_i \quad (12.1)$$

The second portion of the assessment utilizes as a foundation, the already assessed effect on the operating situation of all conflict resolution alternatives $R(RS_{C_f})$ selected during the fixing of the PVSCS combinations. Nonetheless, it complements this information through the assessment of two remaining determining variables determined in subsection 12.2.1. The first complementary determining variable (DV_5) focuses on assessing changes of turning stations introduced in the PVSCS combination during their development (see subsection 9.4). The last complementary determining variable (DV_6), includes in the assessment, the induced end-of-day imbalances in the

whole PVSCS combination. This last determining variable is particularly important to bring the adjustment of the circulation planning under consideration; thus, support all disruption-management problems addressed by the dynamic DRP deployment system. Consequently, as generalized in equation 12.2, the fitness of the PVSCS combination under consideration $R(I_{S,o})$ results from accumulating the assessed effects of all conflict resolution alternatives $R(RS_{C_f})$ utilized for fixing the PVSCS combination and the two complementary weighted determining variables also aligned with the system's general approach (see subsection 3.5.2).

$$R(I_{S,o}) = \sum_{C_f=1}^{C_f} R(RS_{C_f}) + \sum_{i=5}^{i=6} w_i * DV_i \quad (12.2)$$

With the respective evaluation function to be utilized in every portion of the assessment positively established, the actual structure of the approach guiding the assessment can be advanced. The structured approach proposed in this subsection advances the two required processes individually. It does so by acknowledging the need to allow the PVSCS combinations to be fixed entirely before its overall fitness can be ascertained.

As a result, the structured approach guiding the assessment of the conflict resolution alternatives $RS_{C_f}^\gamma$ developed by the CDCR process as part of the dynamic DRP deployment system is depicted in figure 12.1.

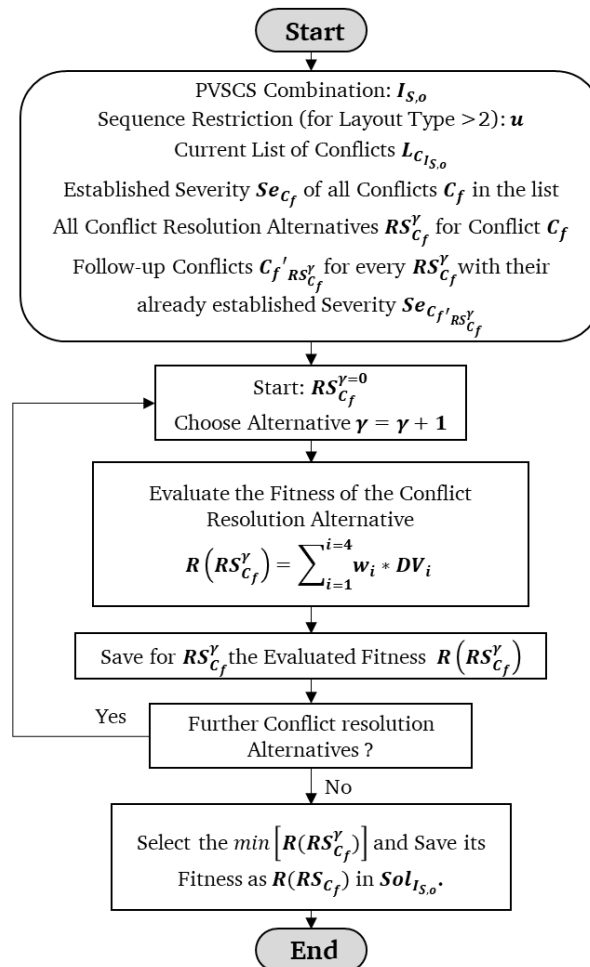

Figure 12.1 Structure for evaluating the effect on the operating situation of conflicts resolution alternatives, as part of an automatic CDCR process (by author)

The structured approach to evaluate the conflict resolution alternatives developed by CDCR process for fixing of a PVSCS combination $I_{S,o}$ is constituted by five steps. Overall, the approach is aligned with the structured approach guiding the CDCR process (see figure 11.1) and supports not only the assessment but also the selection of the conflict resolution alternative among all alternatives that may have been developed to address a listed conflict. Therefore, it is structured in such a way that it assesses the conflict resolution alternatives for one conflict at a time, as detailed by the structured approach guiding the CDCR process.

1. The CDCR process starts by acknowledging and including all necessary information from the CDCR process. Overall, this implies: the conflict currently being handled C_f , the conflict list $L_{C_{I_{S,o}}}$, the set of all “probable” conflict resolution alternatives to establish the severity of every conflict in the list Se_{C_f} (see subsection 11. 5.5) and all conflict resolution alternatives $RS_{C_f}^Y$.
2. Starting with alternative ($\gamma = 0$), the first conflict resolution alternative $RS_{C_f}^{\gamma+1}$ is selected. Together with the resolution alternative, the respective follow-up conflicts $C_f'_{RS_{C_f}^Y}$ and the set of all “probable” conflict resolution alternatives to establish the severity of all follow-up conflicts $Se_{C_f'_{RS_{C_f}^Y}}$ (see subsection 11. 5.5), is acknowledged.
3. The assessed effect $R(RS_{C_f}^Y)$ of the selected conflict resolution alternative $RS_{C_f}^Y$ is ascertained utilizing the evaluation function generalized in equation 12.1.
4. If there are further resolution alternatives $RS_{C_f}^Y$ that have not been assessed, the process returns to step 2, otherwise step 5 is conducted.
5. The conflict resolution alternative with the best-assessed effect $\min R(RS_{C_f}^Y)$, as established by the evaluation function, is selected and saved for the assessed C_f as $R(RS_{C_f}^Y)$ in the set $Sol_{I_{S,o}}$.

With the systematic assessment of every conflict resolution alternative developed in the vehicle-specific CDCR process and the selection of the best alternatives (see section 11 – figure 11.1), the PVSCS combinations may be completely fixed and made conflict-free. At this juncture, the fitness of the resulting conflict-free PVSCS combination can be ascertained.

As depicted in figure 12.2, the approach employs the elements in the set of chosen conflict resolution alternatives $Sol_{I_{S,o}}$, which holds the assessed effect of every conflict resolution utilized to fix the PVSCS combination. Relying on the evaluation function detailed in equation 12.2, it establishes the fitness $R(I_{S,o})$ of the conflict-free PVSCS combination.

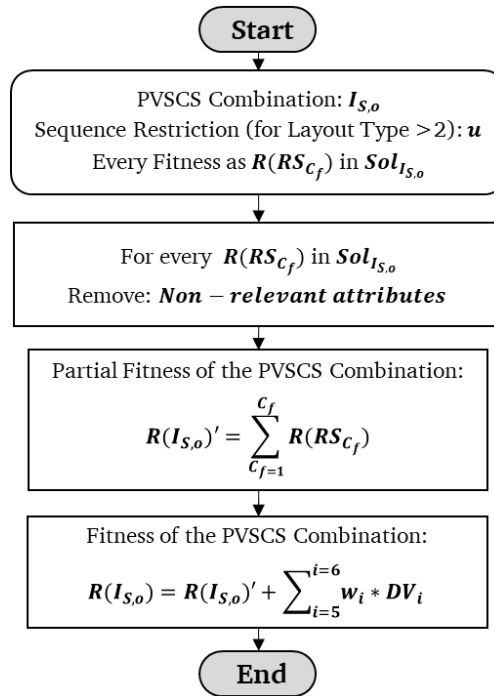

Figure 12.2 Structure for evaluating the fitness of every conflict-free PVSCS combination as part of the dynamic DRP deployment system (by author)

The structured approach foreseen to ascertain the fitness of the PVSCS combination is constituted in five steps. In contrast to the previous process, the evaluation of the PVSCS combination's fitness is independent of the CDCR process; therefore, it does not focus on a single conflict but on the whole PVSCS combination.

1. The assessed effect $R(RS_{C_f})$ of every conflict resolution alternative utilized to fix the PVSCS combination contained in the set $Sol_{I_{S,o}}$, are acknowledged.
2. Since the assessed effect of every conflict resolution alternative utilized to solve the PVSCS combination reflects the influence of the alternative on the operating situation at the moment it has been developed, certain non-relevant attributes may be removed (e.g. the change in the projected operating situation). Thus, to ascertain the fitness of the whole PVSCS combination as accurately as possible, the non-relevant attributes from every $R(RS_{C_f})$ are identified and removed.
3. By adding the refined effect of every conflict resolution alternative $R(RS_{C_f})$ established in step 2, the partial fitness of the PVSCS combination $R(I_{S,o})'$ may be ascertained.
4. Incorporating the results from the complementary evaluation function as detailed in equation 12.2 to the partial fitness of the PVSCS combination $R(I_{S,o})'$, the actual fitness $R(I_{S,o})$ of the PVSCS combination is established.
5. Once the fitness for the combination is established $R(I_{S,o})$ it can be returned either to the Genetic algorithm and/or the Tabu Search (see subsection 10.6 and 10.5, respectively).

The two processes detailed above constitute the structured approach to support the assessment of the conflict resolution alternatives developed in the CDCR process and, ultimately, of the whole PVSCS combinations. While they have been advanced individually, the processes are inherently interrelated. The same is true for the evaluation functions that have been structured and implemented within each one of the processes (see equations 12.1 and 12.2). Nevertheless, the evaluation framework for assessing the effects of every determining variable still requires to be

derived within the context of the dynamic DRP deployment system. By the same token, once the effect of the conflict resolution has been established, the non-relevant attributes still need to be explicitly identified to support a more accurate assessment of the fitness of PVSCS combinations. The following subsections provide a detailed look at each one of these matters.

In the first instance, subsection 12.3 provides a closer look at the evaluation approach of the six determining variables within the context of the existing approaches discussed in subsection 12.2.1. Thereafter, the assessment of the PVSCS combination's fitness aligned with the process detailed in figure 12.2 and supported by the information provided in subsection 12.3, is discussed in further detail throughout subsection 12.4.

12.3. Determining Variables for the Assessment of the Conflict Resolution Alternatives and the PVSCS Combination

The ten determining variables identified in subsection 6.3 have been contrasted against existing approaches, and ultimately, clustered into six resulting determining variables. This subsection provides a detailed account regarding the attributes and general evaluation structure of every single one of the six determining variables utilized in the evaluation function and supporting both assessment processes discussed in subsection 12.2.

At the outset, from the six determining variables, only the three may benefit from frameworks provided by existing approaches to establish their general evaluation structure. The rest are foreseen either utilize structures provided by the dynamic DRP deployment system (i.e. train service cancellation) or derive a completely new assessment structure (i.e. changes of turning stations and induced end-of-day imbalances).

The characteristics and potential attributes to be considered within each of the determining variables foreseen within the assessment module have been considered in subsection 12.2. However, the evaluation approach, attributes, and decision units utilized to establish the assessment of the determining variables must be explicitly detailed. The following subsections provide an in-depth look at the assessment of the six determining variables utilized within the evaluation function.

12.3.1.EP1 – Evaluation of the Expected Relative-Time Changes

This determining variable concentrates on evaluating the expected relative-time changes across all directly involved trains in a conflict resolution alternative $RS_{C_f}^Y$. As discussed in subsection 3.6.2, the expected relative-time change of a train originates from the difference between a train's projected relative-time before the implementation of a conflict resolution alternative and its projected relative-time after the implementation of a conflict resolution alternative. This subsection provides a very detailed discussion and derives an assessment approach that allows assessing the expected relative-time changes in the conflict resolution alternatives developed in the CDCR process part of the dynamic DRP deployment system's approach.

As discussed in subsection 2.2.3 and 12.2.1, existing approaches, which would support an assessment of the expected relative-time changes within an automatic CDCR framework, are available. Approaches like the one introduced in DB Netz (2017), support an evaluation of the expected relative-time change for trains involved in a conflict resolution alternative developed to address conflicts in disturbed operations. The evaluation approach proposed by the DB Netz

(2017) relies on a weighting function to ascertain the expected relative-time changes on every train directly involved in the conflict. The characteristics of the weighting function have been discussed in subsection 2.2.3.

However, as argued in subsection 12.2.2, the implementing field and central objective of the dynamic DRP deployment system is not compatible with the implementing field in which existing approaches are deployed. The existence of disrupted operations and the implementation of a planned disruption-management approach impairs the ability to uphold the dispatching objectives under which the existing approaches have been advanced (see subsection 2.2.3). During disrupted operations, different objectives become preeminent. Punctuality, as well as the restitution of the originally scheduled operations, ceases to be a priority, which is exchanged by an efficient and effective use of capacity and the achievement of stable operations in the shortest possible time (see DB Netz RIL-420 2017). Consequently, and particularly relevant to evaluate the expected relative-time changes in a disruption, utilizing the magnitude of a train's delay as well as its priority (see subsection 2.3.3) to weigh the established changes may not allow reflecting the actual quality of the conflict resolution alternatives.

A closer consideration of the disruption-management would lay the groundwork to establish a much more suitable approach to assess the determining variable. As discussed in subsection 2.3.3, at the beginning of the disruption, there is a very high probability that trains in the commuter railway network driving towards the disrupted section would experience a substantial increase in their delay. As it has been further detailed in subsection 10.2, the handling of these trains is critical for the transitioning of the network to stable operations. At the same time, there are trains in the most distant locations of the network vis-à-vis the disrupted section, which have not been affected by the cause of the disruption. At some point throughout the disruption-management, trains with a significant delay and whose handling may directly influence the stability of the network are bound to enter in conflict with trains that are less or not delayed at all. Therefore, if the requirements of the dynamic DRP deployment system (see subsection 3.4.2) are to be supported, the evaluation of the expected relative-time changes should not be weighted based on the magnitude of delay or the priority of the trains involved in the conflict resolution alternative.

All in all, structuring the determining variable to assess the expected relative-time changes of the conflict resolution strategies as part of the dynamic DRP deployment system ought to be specially tailored to support the discussed requirements in subsection 3.4.2. Consequently, the evaluation of the expected relative-time changes must support an objective account of the assessed conflict resolution alternatives inside a disruption-management framework (i.e. adjustment of the schedule and circulation plans). In this regard, special attention must be given to the utilization of a planned disruption-management approach and the primordial objective for its implementation, namely, the capability of the system to reach the stable operations (see subsection 2.3).

The following subtitle proposes an approach to evaluate the expected relative-time changes along the lineaments detailed as part of the dynamic DRP deployment system.

Proposed Approach to Evaluate the Expected Relative-Time Changes

While existing approaches that allow an evaluation of the expected relative-time changes within a CDCR process are based on weighting the established changes according to the actual train delay and its priority, other operational attributes must be considered to complement the evaluation during disruptions. The identification of additional operational attributes that may be utilized to complement the evaluation implies taking into consideration both the disruption-management

problems addressed by the system and the need to support the disrupted railway network's transition to stable operation.

To identify further operational attributes, a closer consideration of the system's requirements discussed in subsection 3.4.2 would provide a solid starting point. Initially, the system must have general validity and must be able to address two disruption-management problems, namely, the adjustment of the schedule and the circulation plans. Furthermore, as discussed in subsection 3.4.2, the system is also required to ensure the transition to stable operations. In this regard, it must be considered that while the relative-time increases, a train's capability to fulfill its circulation plan without any modification is reduced. Additionally, it must be considered that in commuter railway operations, the density of the service intervals and the limited time available between circulation operations makes the circulation plan of a train particularly vulnerable to significant relative-time changes. Therefore, the expected relative-time change may have a direct influence not only on the trains directly affected by the conflict resolution alternative but also on the train services detailed in each affected trains' adjusted circulation plans. Consequently, it can be assumed that the expected relative-time changes would play a relevant role in: the adjustment of the schedule, the adjustment of the circulation plans, and the transitioning of the network to stable operations.

As a result, the effects of the expected relative-time changes on the affected trains' circulation plan may be an adept operational attribute to complement the evaluation structure of the determining variable developed in this subsection.

An approach to assess the transition of trains to stability during the disruption has already been advanced during the development of the PVSCS; more specifically, by the verification of their operational feasibility (see subsection 9.7). Taking into consideration the effects of the expected relative-time changes on the circulation plans of all directly involved trains, under a similar approach as in the verification of the PVSCS on subsection 9.7, would allow considering both of the disruption-management problems addressed by the system, and at the same time, the network's transition to stable operations.

To evaluate the effects of the expected relative-time changes on the circulation plan of all directly involved trains, the ascertained relative-time changes can be projected onto the transitioning train services appointed by each train's adjusted circulation plan. Accordingly, the resulting evaluation structure of the determining variable would entail, on the one hand, an assessment that focuses on ascertaining the expected relative-time changes of each involved train, and on the other hand, a projection of the established changes on the train services on their circulation plans. With this approach, the evaluation of the determining variable can support the assessment of the transitioning to stable operations and both of disruption problems covered by the dynamic DRP deployment system.

As a result, the evaluation framework of the determining variable to assess the expected relative-time changes is constituted by two different operational attributes. A first attribute that focuses on ascertaining the expected relative-time changes ΔRT of all trains directly involved in the conflict resolution alternative being assessed. This portion of the determining variable is similar to existing approaches (i.e. Oetting et al. 2013, DB Netz 2017). A second attribute that projects the expected relative-time changes $\Delta RT_{Circulation}$ on the transition train services appointed in the circulation plan of all trains directly involved in the conflict resolution alternative. These parameters are additively linked together, as generalized in equation 12.3.

$$DV_1 = \sum_i \Delta RT_{T_{IS},i} + \Delta RT_{Circulation} \quad (12.3)$$

The evaluation of the determining variable is generalized in equation 12.3, which allows performing an immediate evaluation of the relative-time changes and their impact on the transition to stable operations of all directly involved trains.

The following subtitles, provide a closer look at each of the portions that constitute the determining variable of the expected relative-time change.

Evaluate the Expected Relative-Time Change of all Directly Involved Trains

To evaluate the expected relative-time change generated by the conflict resolution alternative $RS_{C_f}^Y$, the spatiotemporal changes introduced by the conflict resolution alternative must be accounted for each of the directly involved trains. As discussed in subsection 12.2.2, the approach described in subsection 2.2.3 can be utilized to ascertain the expected relative-time changes on these trains. This subtitle briefly discusses the process necessary to ascertain the expected relative-time change, which is generalized from the existing approach provided by DB Netz (2017).

Overall, to establish the expected relative-time changes, two matters are of the utmost importance. First, establishing the temporal modifications introduced by the assessed conflict resolution alternative on the directly involved trains (see subsection 3.6.2). Second, as discussed in subsection 2.2.3, the expected relative-time changes of every involved train must be ascertained throughout all relative-time measuring points, as discussed in subsection 2.3.3 and 3.6.2.

A brief discussion regarding the means to ascertain the temporal changes throughout the relative-time measuring points within the context of the dynamic DRP deployment system is introduced.

At the outset, the expected relative-time change for each train consists of both temporal and spatial modifications introduced by the elemental conflict solution alternative(s) utilized during the development of the assessed $RS_{C_f}^Y$ (see subsection 11.5). As summarized in table 12.1, both temporal and spatial modifications are considered simultaneously since both have an influence on the relative-time change of a train.

By including the temporal modification introduced by the conflict resolution alternative on each of the directly involved trains, their relative-time changes are projected in the system. These projections must be registered at every relative-time measuring point (DB Netz RIL-420, 2017 - see subsection 3.6.2). In the case of the dynamic DRP deployment system, due to the utilized infrastructural modelling, these points are acknowledged at every possible stopping position of the train (i.e. end of track and platform tracks at stations). Furthermore, to further align the approach with the evaluation structure of the determining variable, the relative-time measuring points can be further detailed depending on the specific situation of each conflict resolution alternative and the computing effort available. It is possible to analyze the expected relative-time changes introduced by the resolution alternative throughout every relative-time measuring point in the train's route from the element utilized to implement the conflict resolution alternative. Another option is to restrict the elements, for example, only at the stations where passenger exchange is to be conducted as in D'Ariano (2008).

Regardless if all or only certain elements are assessed, at every considered relative-time measuring point, the expected relative-time change $\Delta RT_{T_{IS},i}$ must be ascertained. The expected relative-time

change $\Delta RT_{T_{l_s,i}}$ can be ascertained utilizing equations 2.9, 2.10 and 2.11 described in subsection 2.2.3. These equations are generalized for their use in the dynamic DRP deployment system as detailed in equations 12.4, 12.5 and 12.6.

$$\Delta RT_{T_{l_s,i}} = \Delta t_{Proj-RS_{C_f}^Y-T_{l_s,i}} - \Delta t_{Proj-T_{l_s,i}} \quad (12.4)$$

$$\Delta t_{Proj-T_{l_s,i}} = t_{Proj-T_{l_s,i}} - t_{Sched-T_{l_s,i}} \quad (12.5)$$

$$\Delta t_{Proj-RS_{C_f}^Y-T_{l_s,i}} = t_{Proj-RS_{C_f}^Y-T_{l_s,i}} - t_{Sched-T_{l_s,i}} \quad (12.6)$$

In equation 12.4, the expected relative-time change $\Delta RT_{T_{l_s,i}}$ for train $T_{l_s,i}$ as part of the conflict resolution alternative $RS_{C_f}^Y$ derives from the difference between the projected relative-time $\Delta t_{Proj-RS_{C_f}^Y-T_{l_s,i}}$ product of implementing the conflict resolution alternative and the actual projected relative-time $\Delta t_{Proj-T_{l_s,i}}$. The actual projected relative-time $\Delta t_{Proj-T_{l_s,i}}$ for train $T_{l_s,i}$ is acquired as in equation 12.5; where the train's scheduled arrival, departure or drive-through time $t_{Sched-T_{l_s,i}}$ is subtracted from the actual projected arrival, departure or drive-through time $t_{Proj-T_{l_s,i}}$ from, to, or at, the assessed relative-time measuring point.

Furthermore, the projected relative-time change product of implementing the conflict resolution alternative $\Delta t_{Proj-RS_{C_f}^Y-T_{l_s,i}}$ for train $T_{l_s,i}$ is acquired as in equation 12.6; where the train's scheduled arrival, departure or drive-through time $t_{Sched-T_{l_s,i}}$ is subtracted from the projected arrival, departure or drive-through time product of implementing the conflict resolution alternative $t_{Proj-RS_{C_f}^Y-T_{l_s,i}}$ from, to, or at, the assessed relative-time measuring point.

Since according to the existing approach discussed in subsection 2.2.3, more than one relative-time measuring point is analyzed for every train, it is necessary to establish an approach in order to ascertain the resulting $\Delta RT_{T_{l_s,i}}$. For this, the following approach is proposed by the German infrastructure manager guideline RIL-420 (DB Netz RIL-420 2017):

- i) Compute an average value of $\Delta RT_{T_{l_s,i}}$ across all analyzed relative-time measuring points.

However, the following approaches can also be considered:

- ii) Compute a weighted average of $\Delta RT_{T_{l_s,i}}$ in correspondence to the distance in which the change has been introduced.
- iii) To account for the worst operating situation, the $\Delta RT_{T_{l_s,i}}$ that generates the maximum change with the actual projected situation may also be utilized.
- iv) Focus on the $\Delta RT_{T_{l_s,i}}$ at the end station in order to consider the recorded delay at the end of the trains service and support its projection on the transition train service appointed in its circulation plan.

Since the expected relative-time change must be able to reflect the actual effect of the conflict resolution alternative on the operating situation as discussed in the final paragraph of the previous subtitle, it is recommended to use the approach i) proposed by DB Netz RIL-420 (2017) to ascertain a consistent representation of the expected relative-time changes. This approach would also

support the capability of projecting every train's expected relative-time changes on the train services specified by their circulation plan.

Moreover, depending on the implementing field (e.g. in cases where there is an interaction between passenger trains and freight trains) if the priority of the involved trains is relevant, the relative-time changes $\Delta RT_{T_{ls,i}}$ may be affected by the weighting values advanced in the approach introduced by DB Netz (2017) and discussed in subsection 2.2.3. However, as discussed in the previous subtitle, and considering the system requirements (see subsection 3.4.2), it is recommended to leave the ascertained relative-time changes completely unaffected.

All in all, the expected relative-time change $\Delta RT_{T_{ls,i}}$ for all the trains involved in the conflict resolution alternative $RS_{C_f}^Y$ are ascertained as discussed throughout this subtitle.

Evaluate the Expected Relative-Time Change in the Circulation Plan

The effects on the transition train services detailed in the circulation plan of all directly involved trains are utilized to complement the evaluation of the expected relative-time changes. As discussed in subsection 9.7, the ability to generate an on-time train service after the transition between train services is of utter importance for facilitating the network's ability to reach stable operations. This subtitle discusses the means to project the expected relative-time changes, which have been ascertained as in the previous subtitle, onto the transition train service appointed by the circulation plan of every train directly involved in the conflict resolution alternative.

Initially, it is necessary to establish the number of transition train services in the circulation plan that are to be considered. While there is not a limit on the number of transitions between train services that may be taken into account, the evaluation is limited to the first transition train service in every train's circulation plan. While further transition train services can be included, only the first transition train serviced is considered in order to reduce the uncertainty during the assessment.

Under the proposed approach, the attribute being assessed focuses on projecting the expected relative-time changes $\Delta R_{T_{ls,i}}$ on the immediate transition train service of every train directly involved in the conflict resolution alternative. The projection of these changes must be held for all three types of circulation between train services handled in the dynamic DRP deployment system, namely: turning, coupling and decoupling. As generalized in equation 12.7, the influence of the expected relative-time changes on every type of circulation contained by all directly involved trains in the conflict resolution alternative is added to establish the $\Delta RT_{Circulation}$.

$$\Delta RT_{Circulation} = \sum_Q \Delta RT_{Turn,Q} + \sum_R \Delta RT_{Coupling,R} + \sum_P \Delta RT_{Decoupling,P} \quad (12.7)$$

The expected relative-time change acquired in the previous subtitle for every directly involved train in the conflict resolution alternative is projected to its transition train service Q , as established by its adjusted circulation plan. The expected relative-time change across all transition train services is added to establish the expected relative-time change throughout the circulation plan $\Delta RT_{Circulation}$ of all directly involved trains.

The expected relative-time changes for every transition train services involved in the conflict resolution alternative may be established as already detailed by equation 12.4. Introducing minor

modification to equation 12.4, the expected relative-time changes for every transition type handled by the dynamic DRP deployment system may be generalized as detailed in equation 12.8.

$$\Delta RT_{Coupling,R} = \Delta RT_{Turn,Q} = \Delta RT_{Decoupling,P} = \Delta t_{Proj-RS_{C_f}^Y-Q} - \Delta t_{Proj-Q} \quad (12.8)$$

Equation 12.8, supports the capability to project the expected relative-time change on every transition train service Q (e.g. for a turn $\Delta RT_{Turn,Q}$) appointed by the circulation plan of a directly involved train $T_{l_s,i}$ in the conflict resolution alternative $RS_{C_f}^Y$. Utilizing the case of a turn $\Delta RT_{Turn,Q}$ as an example, the projection of the expected relative-time change of a train $T_{l_s,i}$ on its immediately appointed transition train service Q results from a difference between the projected relative-time product of implementing the conflict resolution alternative $\Delta t_{Proj-RS_{C_f}^Y-Q}$ and the actual projected relative-time Δt_{Proj-Q} .

Moreover, the projected relative-time product of implementing the conflict resolution alternative $\Delta t_{Proj-RS_{C_f}^Y-Q}$ is acquired as in equation 12.6. In equation 12.9, the scheduled departure time of the transition train service from the station after the transition between services has taken place $t_{Sched.Dep-Q}$ is subtracted from the projected departure time product of implementing the conflict resolution alternative $t_{Proj.Dep-RS_{C_f}^Y-Q}$ from the station. In the same way, the actual projected relative-time Δt_{Proj-Q} is acquired as in equation 12.5; where the train's scheduled departure time $t_{Sched.Dep-Q}$ is subtracted from the actual projected departure time $t_{Proj.Dep-Q}$ from the station after the transition has taken place (see equation 12.10).

$$\Delta t_{Proj-RS_{C_f}^Y-Q} = t_{Proj.Dep-RS_{C_f}^Y-Q} - t_{Sched.Dep-Q} \quad (12.9)$$

$$\Delta t_{Proj-Q} = t_{Proj.Dep-Q} - t_{Sched.Dep-Q} \quad (12.10)$$

Since this portion of the determining variable, namely, the $\Delta RT_{Circulation}$, computes expected relative-time changes, the respective relative-time measuring points where the evaluation is conducted must be established. There are different considerations that may be advanced to establish which relative-time measuring points to consider. On the one hand, it is possible to consider only the station where the transition is being conducted. Another approach can concentrate on all the measuring points along the transition train service's route.

While considering all possible measuring points may lead to a somewhat more accurate evaluation, the evaluation focuses solely on the transition between the train services. Furthermore, any negative effect induced by the projected relative-time changes throughout the transition train service's route would be handled as follow-up conflicts in later steps of the CDCR process. Therefore, there would be little to no benefit in ascertaining the projected information throughout a series of measuring points. As the standard approach, it is recommended that the expected relative-time changes for the transition train services are assessed only at the station where the transition is being conducted. This can be later adjusted, depending on the computational effort and following the system's implementation in actual disrupted situations.

On another note, as discussed in subsection 2.3.3, Chu (2014) sustains that the minimum turning times cannot always be respected during disrupted operations. An approach must be put forward so as to account for the stochastic nature of the projected transition between train services during

disrupted operations. Efforts aimed in this direction would allow developing a much more representative projection of the expected relative-time changes on the transition train services.

To take into account the stochastic nature of the transition between train services, a supplement transition time can be introduced during the projection of every scheduled transition between train services. Utilizing a similar approach as the one utilized in subsection 9.7, the expected relative-time changes and their projection on the transition train services have been generalized in equations 12.9 and 12.10. Equation 12.11, allows ascertaining the projected departure time product of implementing the conflict resolution alternative $t_{Proj.Dep-RS_{C_f}^Y-Q}$ by adding the minimum transition time $min t_{Trans}$ and a supplement transition time $t_{Trans.Add}$, to the projected arrival of train $T_{l_s,i}$ to the station where the transition must take place product of implementing the conflict resolution alternative $t_{Proj.Arr-RS_{C_f}^Y-T_{l_s,i}}$. In the same way, equation 12.12 allows ascertaining the actual projected departure time $t_{Proj.Dep-Q}$ from the station by adding the minimum transition time $min t_{Trans}$ and a supplement transition time $t_{Trans.Add}$ to the actual projected arrival time of train $T_{l_s,i}$ at the station where the transition is scheduled to take place $t_{Proj.Arr-T_{l_s,i}}$.

$$t_{Proj.Dep-RS_{C_f}^Y-Q} = t_{Proj.Arr-RS_{C_f}^Y-T_{l_s,i}} + min t_{Trans} + t_{Trans.Add} \quad (12.11)$$

$$t_{Proj.Dep-Q} = t_{Proj.Arr-T_{l_s,i}} + min t_{Trans} + t_{Trans.Add} \quad (12.12)$$

One last verification must be conducted to ensure that the projection abides with the scheduled departure of the transition train service from the station where the transition is being assessed. As the last step required to project the expected relative-time change on the immediate transition train service of a directly involved train, both the projected departure time product of implementing the conflict resolution alternative $t_{Proj.Dep-RS_{C_f}^Y-Q}$ and the actual projected departure time $t_{Proj.Dep-Q}$ must be contrasted against the scheduled departure time of the trains service $t_{Sched.Dep-Q}$ from the station. As a result, the following cases must be recognized:

- If the $t_{Proj.Dep-RS_{C_f}^Y-Q}$ calculated as in equation 12.11 or the $t_{Proj.Dep-Q}$ calculated as in equation 12.12, are larger than the scheduled departure time of the train service $t_{Sched.Dep-Q}$ from the station; then, the values do not need to be modified.
- If the $t_{Proj.Dep-RS_{C_f}^Y-Q}$ calculated as in equation 12.11 or the $t_{Proj.Dep-Q}$ calculated as in equation 12.12, are lower or equal to the scheduled departure time of the train service $t_{Sched.Dep-Q}$ from the station; then the values acquire the value of the $t_{Sched.Dep-Q}$.

The supplement transition time $t_{Trans.Add}$ must be explicitly recognized for every transition type. As discussed in subsection 2.3.3, a detailed statistical evaluation of the actual turning time required for trains during disrupted operations has been introduced in Chu (2014). The analysis distinguishes between turns with one and with two drivers available on the train and provides supplements that can be added to the minimum turning time during disruptions (see subsections 2.3.3 and 3.6.2). However, no similar analysis has been found in the case of coupling or decoupling of trains.

The recommended values for the supplement transition time $t_{Trans.Add}$ are displayed in table 12.2, where the minimum transition times discussed in subsection 3.6.2 are also provided for comparative purposes.

Table 12.2 Supplement transition times (by author)

Transition type	Minimum Transition Time ($\min t_{Trans}$)	Supplement Transition time ($t_{Trans.Add}$)
Turn	1 Driver: $\min t_{Turn} = 6 \text{ min}$	1 Driver: $t_{Turn.Add} = 3 \text{ min}^*$
	2 Drivers: $\min t_{Turn} = 2 \text{ min}$	2 Drivers: $t_{Turn.Add} = 3 \text{ min}^*$
Coupling	$\min t_{Coupling} = 5 \text{ min}$	Information not Available
Decoupling	$\min t_{Decoupling} = 3 \text{ min}$	Information not Available

* Values established in Chu (2014, p.103).

Table 12.2 details for every transition type handled in the dynamic DRP deployment system, both the minimum transition time (see subsection 3.6.2) and the recommended supplement transition time. The minimum transition times are included to facilitate the comparison between the minimum transition time and the recommended supplement transition times. For the coupling and decoupling, no statistical analysis exists to date that permits to establish the actual coupling or decoupling times during disrupted situations. However, it must be considered that the actual coupling time is highly influenced by the probability of delay in any of the trains involved in the coupling process.

Summary

The approach proposed in this subsection supports the evaluation of the expected relative-time changes as part of the dynamic DRP deployment system. The resulting determining variables allow assessing the expected relative-time changes on all directly involved trains in the conflict resolution alternative and their effects on their adjusted circulation plans.

Furthermore, the projection of the expected relative-time changes on the transition train services has been supported by including a supplement transition time value. The recommended supplements allow the approach to take into consideration the stochastic nature of the projected transition between train services during disrupted operation. However, the supplements for coupling and decoupling operations between train services could not be ascertained, as a detailed statistical evaluation of the actual turning time required for trains during disrupted operations still needs to be conducted.

12.3.2.EP2 – Changes in the Projected Operating Situation

This determining variable concentrates on providing the system with its required look-ahead capability within the CDCR process. As discussed in subsection 3.5.2, supporting the look-ahead capability in the system entails ascertaining the change in the projected operating situation induced by a conflict resolution alternative and utilizing the obtained information as part of the assessment.

Overall, there are different approaches to assess the change in the projected operating situation induced by a conflict resolution alternative. As discussed in subsection 11.3.2, within the dynamic DRP deployment system, the induced change derives from ascertaining the fluctuation in the number and severity of the conflicts in the list vis-à-vis the follow-up conflicts induced by the

prospective implementation of a conflict resolution alternative. This subsection provides a detailed discussion and derives a determining variable that allows to include the ascertained change in the projected operating situation of every conflict resolution alternative developed in the CDCR process as part of the overall dynamic DRP deployment system's approach.

As discussed in subsection 2.2.3, existing approaches may be utilized to ascertain the change in the projected operating situation within a CDCR framework. However, the evaluation structured in this subsection has been already established in section 11 and supported by the CDCR process (see section 11, figure 11.1). The evaluation approach has been structured along with the principles outlined in Oetting et al. (2013), which proposes ascertaining the changes induced in the projected operating situation by comparing the situation before and after a prospective implementation of the conflict resolution alternative $RS_{C_f}^Y$ being assessed. Therefore, the changes in the projected operating situation are essentially a comparison between the number and the severity of the conflicts before and after the prospective implementation of a conflict resolution alternative. The assessment utilizes the information of conflict severity as the attribute to structure its evaluation approach.

Within the CDCR process, the severity of all conflicts in the conflict list has already been established as a set Se_{C_f} , which may contain several "probable" conflict resolution alternatives $RS_{C_f}^{Yse}$ (see subsection 11.5). However, the "probable" conflict resolution alternatives $RS_{C_f}^{Yse}$ in the set still need to be assessed so as to support the selection of the most suitable alternative and, ultimately, establish the magnitude of the conflict severity. Furthermore, every conflict resolution alternative $RS_{C_f}^Y$ that is developed as part of the CDCR process, is projected on the operating situation and its follow-up conflicts are identified (see subsection 11.4.). The severity of the induced follow-up conflicts have also been established as a set $Se_{C_f', RS_{C_f}^Y}$ of "probable" conflict resolution alternatives $RS_{C_f', RS_{C_f}^Y}^{Yse}$ that, as in the previous case, still require an assessment to support the selection of the best possible alternative (see subsection 11.5).

Consequently, before the change in the projected operating situation can be assessed, the "probable" conflict resolution alternatives in each set must have their effects assessed. The assessment allows to identify the "probable" conflict resolution alternative with the minimum effect on the operating situation, and the rest of the alternatives can be deleted. In due course, the assessed effect of the chosen "probable" conflict resolution alternative would constitute the magnitude of the conflict severity, regardless if it is a conflict in the list or a follow-up conflict. Once the magnitude of the conflict severity has been established, the induced change in the projected operating situation of the conflict resolution alternative $RS_{C_f}^Y$ can be assessed.

An evaluating structure that supports an assessment of the changes in the projected operating situation has already been detailed in subsection 2.2.3. As it has been discussed in the model introduced by Oetting et al. (2013), the expected change in the projected operating situation acknowledges that change must stem from comparing the difference in the severity before and after the projection of a conflict resolution alternative $RS_{C_f}^Y$ on the operating situation. To align the approach with the framework already introduced in subsection 11.3.2 and support its implementation in the dynamic DRP deployment system, equation 12.13 utilizes the principles detailed in Oetting et al. (2013) to generalize the evaluation of the changes in the projected operating situation.

$$DV_2 = \Delta OS = OS_{Proj-RS_{C_f}^y} - OS_{Proj} \quad (12.13)$$

The determining variable focuses on assessing the induced change in the projected operating situation ΔOS after a prospective implementation of the conflict resolution alternative $RS_{C_f}^y$ under consideration. The change in the projected operating situation is attained through the difference between the actual projected operating situation OS_{Proj} and the projected operating situation induced by a prospective implementation of the conflict resolution alternative $OS_{Proj-RS_{C_f}^y}$.

As a result, from all considerations detailed thus far, an evaluation of the changes in the projected operating situation as part of the overall assessing framework would entail two general tasks (see figure 11.1). Firstly, it is still necessary to ascertain the effects of all the “probable” conflict resolution alternatives within the conflict severity sets, which permits to establish the actual magnitude of every conflict’s severity. Secondly, with the severity of all listed and follow-up conflicts established, the change in the projected operating situation may be assessed, as generalized in equation 12.13.

The following subtitles provide a general discussion on the two general tasks that support evaluating the induced change in the projected operating situation by the conflict resolution alternative under consideration.

Assessing the Effect of the “Probable” Conflict Resolution Alternatives

The evaluation of the “probable” conflict resolution alternatives $RS_{C_f}^{ySe}$ and $RS_{C_f'RS_{C_f}^y}^{ySe}$ in the sets Se_{C_f} and $Se_{C_f'RS_{C_f}^y}$ is detailed in this subsection. The evaluation allows ascertaining the magnitude of every identified conflict’s severity. This subtitle provides further detail regarding the means to establish the magnitude of every conflict’s severity, regardless if it is a conflict in the list or a follow-up conflict.

Assessing the effects of the “probable” conflict resolution alternatives within each established set is, in principle, no different task than assessing the fitness of any other conflict resolution alternative handled within this module. However, the main difference dwells in the fact that this assessment needs to be conducted every time a conflict resolution alternative has been selected and every time a conflict resolution alternative has been developed (see subsection 11.3.2, figure 11.1). Therefore, depending on the computational effort available, the assessment may be adjusted accordingly.

Potential adjustments have been initially discussed during the development of the “probable” conflict resolution alternatives in subsection 11.5.5. It has been argued that certain conflict types can be left out of the assessment so as to make it more attuned with the computational effort available; however, it has also been pointed out that to guarantee the effectiveness of the dynamic DRP deployment system all conflict types should be supported.

Overall, all the determining variables that support the CDCR process (i.e. EP: 1, 3 and 4) may be utilized to assess the “probable” conflict resolution alternatives (see subsection 12.2.2). However, taking into consideration the objective for ascertaining the conflict severity (see subsection 2.2.3), certain parameters would inherently acquire particular relevance. Between the three available determining variables, number 1 allows evaluating the expected relative-time change (i.e. DV_1), number 3 supports an assessment regarding the change of platform tracks (i.e. DV_3), and number

four focuses on train service cancellations (i.e. DV_4). Determining variables 1 and 4 are indispensable to account for the operational and passenger related effects introduced by the “probable” conflict resolution alternatives. DV_1 would be enough to ascertain the fitness of the resolution alternative from an operational perspective. However, due to the system’s requirements detailed in subsection 3.4.2, DV_4 must also be included in the assessment. Therefore, as part of the dynamic DRP deployment system, it is recommended that the severity of a given conflict reflects the evaluation supported by DV_1 and DV_4 . The remaining determining variable (i.e. DV_3), may be included in the evaluation depending on the needs of the implementing field of the system.

As a result, the assessed effects of the “probable” conflict resolution alternatives $R(RS_{C_f}^{Yse})$ or $R(RS_{C_f'RS_{C_f}}^{Yse})$ may be ascertained as generalized in equation 12.14. Equation 12.4 details a uniformed approach to assess the effects of the “probable” conflicts resolution alternatives for both listed and follow-up conflicts simultaneously (i.e. regardless of the set Se_{C_f} and $Se_{C_f'RS_{C_f}}^{Y}$), incorporating all three determining variables discussed above.

$$R(RS_{C_f}^{Yse}) = R(RS_{C_f'RS_{C_f}}^{Yse}) = w_1 * DV_1 + w_3 * DV_3 + w_4 * DV_4 \quad (12.14)$$

Since all the determining variables are weighted and deliver an assessment from a temporal perspective, the effects of the “probable” conflict resolution alternatives $R(RS_{C_f}^{Yse})$ or $R(RS_{C_f'RS_{C_f}}^{Yse})$ can be immediately utilized to select the best possible element in the set. As with any regular conflict resolution alternative, the best conflict resolution alternative is identified by extracting the element with the minimum assessed effect on the operating situation. Ultimately, the magnitude of every conflict’s severity SE_{C_f} or $SE_{C_f'RS_{C_f}}^{Y}$ is ascertained as generalized in equations 12.15 and 12.16.

$$SE_{C_f} = \min Se_{C_f} \quad (12.15)$$

$$SE_{C_f'RS_{C_f}}^{Y} = \min Se_{C_f'RS_{C_f}}^{Y} \quad (12.16)$$

Having established the means to establish the magnitude of the severity for both the conflicts in the conflict list C_f and follow-up conflicts $C_f'RS_{C_f}^{Y}$, the changes in the projected operating situation may now be fully assessed.

Evaluation of the Changes in the Projected Operating Situation

As generalized in discussed in subsection 12.2.1, evaluating the changes in the projected operating situation is ascertained by comparing the projected operating situation before and after the prospective implementation of the conflict resolution alternative under consideration. This subtitle derives and details the evaluation structure of a determining variable that allows assessing the changes in the projected operating situation induced by a prospective implementation of the assessed conflict resolution alternative $RS_{C_f}^{Y}$.

Generalized in equation 21.13, the change in the projected operating situation can be ascertained through the difference between the actual projected operating situation OS_{Proj} and the projected operating situation induced by a prospective implementation of the conflict resolution alternative $OS_{Proj-RS_{C_f}^Y}$. As discussed in subsection 2.2.3 and 11.3.2, the operating situation is ascertained by the number and severity of all conflicts recognized in the system at a definite moment in time. Equation 12.17 provides an overview and further specifies the evaluation of the changes in the projected operating situation. Initially, the operating situation is ascertained by adding the severity of all identified conflicts. In case of the actual projected operating situation OS_{Proj} , this entails the severity SE_{C_f} of every conflict currently found in the conflict list. In the case of the projected operating situation induced by a prospective implementation of the conflict resolution alternative $OS_{Proj-RS_{C_f}^Y}$, this entails the severity $SE_{C_{f'}RS_{C_f}^Y}$ of every identified follow-up conflicts. Ultimately, by attaining the difference between the aggregated values of both projected and actual operating situations, the change in the projected operating situation is finally established.

$$DV_2 = \Delta OS = OS_{Proj-RS_{C_f}^Y} - OS_{Proj} = \sum_1^{C_{f'}} SE_{C_{f'}RS_{C_f}^Y} - \sum_1^{C_f} SE_{C_f} \quad (12.17)$$

Assessing the induce change in the projected operating situation by the conflict resolution alternative under consideration $RS_{C_f}^Y$ as specified in equation 12.17 would entail that the ascertained severity of all conflicts in the list is equally relevant in the evaluation. Nonetheless, as it has been discussed in subsection 2.2.3, the severity of the conflict resolution alternatives may be weighted to account for the distance in time between the conflict C_f being addressed by the conflict resolution alternative under consideration $RS_{C_f}^Y$ and every subsequent conflict in the list.

In Sulyok (2018), the severity of every conflict is weighted in correspondence to the temporal distance to the conflict addressed by the conflict resolution alternative under consideration. The approach is introduced within the context of a real-time CDCR decision-support system targeted at supporting the evaluation of a series of conflict resolution alternatives utilized to address disturbed operations. The approach acknowledges the existence of a simulation interval and a horizon for conducting the conflict identification. The considerations regarding the need to weigh the conflict severity in time are based on the effort required by a dispatcher to handle the conflicts. The weighting function is arranged as a decreasing linear function in time. Thus, the more distant in time, the conflicts are from the conflict currently being addressed, the lower they are weighted as the dispatchers are considered to have a longer time to react to the situation.

However, in the case of the dynamic DRP deployment system, the considerations regarding the need for a weighting function are founded over different considerations like the one proposed in Sulyok (2018). The considerations advanced in the proposed approach concentrate on the effect that the conflict resolution alternative $RS_{C_f}^Y$ under consideration has on the projected operating situation (i.e. severity) of conflicts which are further distant in time. Thus, due to the imminent handling of subsequent conflicts, the relevance or weight of the severity of a given conflict can be reduced vis-à-vis its temporal distance to the conflict currently being handled.

Currently, there is no existing study that supports the establishment or provides an approach to ponder the influence on subsequent conflicts after the prospective implementation of a conflict resolution alternative (see Sulyok 2018). Therefore, different alternatives may be considered to

structure a weighting function that allows taking into consideration a reduction in the relevance of a conflict's ascertained severity depending on its temporal distance to the conflict addressed by conflict resolution alternative under consideration $RS_{C_f}^Y$.

Initially, since the function must represent a decaying relevance in time, a linear or a negative exponential function may constitute adept alternatives. Further function types may also be considered (e.g. logarithmic decay). However, a comprehensive and generalized representation of the change in relevance can be supported by structuring the weighting function utilizing a simple approach, such as those provided by functions with linear or negative exponential properties.

Furthermore, the operational environment addressed by the dynamic DRP deployment system may be utilized to support the structuring and calibration of the weighting function so as to allow an objective assessment of the induced change in the projected operating situation. Consequently, the approach guiding the CDCR process and assessment modules as part of the overall dynamic DRP deployment system is taken into consideration, and six considerations introduced. The six considerations described below lay the groundwork to derive the weighting function.

- i) A sufficiently accurate parameter to ascertain the distance between conflicts may be acquired through the already established temporal occurrence t_{C_f} (i.e. time in which every conflict is registered in the system) of every conflict identified by the CDCR process (see subsection 11.4).
- ii) The system's handling of disrupted operations implies that the total number of conflicts being identified at once is likely to be elevated. Thus, the higher the number of conflicts that need to be handled in the subsequent steps, implies that the severity should reduce at a much more considerable rate.
- iii) The estimated disruption length t_{EDL} stands as an essential temporal quantity within the dynamic DRP deployment system. This is the case since the system must be able to ensure the network reaches stability and remains stable during the disruption. Consequently, the estimated disruption length t_{EDL} may constitute a relevant temporal reference to establish the horizon for projecting the changes in the operational environment.
- iv) The estimated disruption length t_{EDL} would also provide a hint regarding the extent and complexity of the disruption. For longer lengths, it may be considered that the disruption is prone to cause a higher number of conflicts (particularly at the beginning of the disruption). Therefore, the weighting function must be calibrated accordingly.
- v) The weight regarding the severity of conflicts that occurred at the same time to the conflict addressed by conflict resolution alternative under consideration $RS_{C_f}^Y$ is equal to 1.
- vi) To calibrate the weighting function, an important benchmark is considered to be the temporal distance at which the weighting function would render an ascertained conflict severity to be only half as relevant as the one that is registered to take place at the same time (i.e. weight is equal to 0.5).

With the six considerations discussed above, the weighting functions may now be structured and calibrated. First, the registered temporal occurrence t_{C_f} (i.e. time in which the conflict is registered in the system) of every identified conflict is acknowledged. The temporal occurrence t_{C_f} allows ascertaining the temporal distance between every conflict in the list (or follow-up conflict) and the conflict addressed by conflict resolution alternative under consideration $RS_{C_f}^Y$. The temporal occurrence of the conflict addressed by conflict resolution alternative under consideration $RS_{C_f}^Y$ is

henceforth recognized as $t_{C_f^{U.C}}$. Therefore, the temporal distance between conflicts $t_{Dis_{C_f-C_f^{U.C}}}$ may be ascertained as detailed in equation 12.18.

$$t_{Dis_{C_f-C_f^{U.C}}} = t_{C_f} - t_{C_f^{U.C}} \quad (12.18)$$

Having ascertained the temporal distance, the structure of both a linear and negative exponential function can be derived and subsequently calibrated. As discussed above, while other functions may be considered to represent the decaying relevance of the severity of a conflict in time, two general alternatives can be easily established through linear and negative exponential functions. However, the effectiveness of the proposed representations and, in fact, of any other mathematical representation can only be fully determined through their implementation within actual cases, which is recognized as one of the limitations of the system (see subsection 3.3.2).

Supported by consideration *i*), the weighting function can be expressed as a function of the ascertained temporal distance between conflicts $t_{Dis_{C_f-C_f^{U.C}}}$. Furthermore, according to consideration number *v*), the y-intercept should be located in 1, as this point would indicate a temporal distance between conflicts $t_{Dis_{C_f-C_f^{U.C}}}$ equal to 0, where the weight of the conflict severity is equal to 1. The overall arrangement of both linear and exponential functions following considerations *i*) and *v*) are depicted in figure 12.3.

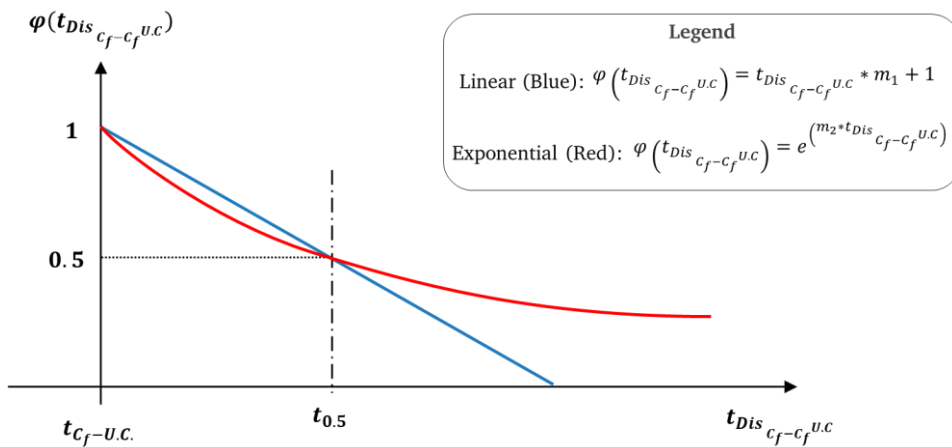

Figure 12.3 Proposed conflict severity weighting functions (by author)

The first alternative is constituted by the linear weighting function, as depicted in figure 12.3 and generalized in equation 12.19. In this case, the weighting function is expressed a linear decay of the weight of the ascertained conflict severity as a function of the temporal distance between conflicts $t_{Dis_{C_f-C_f^{U.C}}}$.

$$\varphi\left(t_{Dis_{C_f-C_f^{U.C}}}\right) = t_{Dis_{C_f-C_f^{U.C}}} * m_1 + 1 \quad (12.19)$$

The function's slope m_1 is the parameter that must be calibrated according to the framework introduced by the considerations described above. According to consideration *vi*), the calibration is guided by time $t_{0.5}$, which represents the temporal distance in which the function weighs the severity of a conflict half as much as a conflict which occurs simultaneously to the conflict addressed by conflict resolution alternative under consideration $RS_{C_f}^V$. A generalized approach to acquire the function's slope and support its calibration is detailed in equation 12.20.

$$m_1 = \frac{-0.5}{t_{0.5}} \quad (12.20)$$

The time $t_{0.5}$ can be introduced manually, depending on the implementing field. However, to calibrate the time $t_{0.5}$ certain generalizations can be introduced. Initially, as discussed in consideration *iv*), the estimated length of the disruption may play a relevant role in supporting the calibration. As expected, the higher the value of $t_{0.5}$, the lower the decay in respect to the temporal distance. Equation 12.21 is proposed to incorporate the length of the disruption, expressing it as a function of time $t_{0.5}$. Equation 12.21 supports the establishment of $t_{0.5}$ by dividing the squared value of a calibrating time t_{cal} by the estimated disruption length t_{EDL} . The larger the calibrating time t_{cal} , the lower the rate of the decay in the severity of the conflict with respect to the temporal distance.

$$t_{0.5} = \frac{t_{cal}^2}{t_{EDL}} \quad (12.21)$$

Consideration *iv*) can provide further insight to derive the calibrating time t_{cal} . It has been suggested that for longer estimated disruption lengths, the complexity of the disruption would be greater, and the number of conflicts being generated would also be elevated. With a higher number of conflicts being generated, the ascertained severity of a conflict should decay faster in time. Furthermore, according to consideration *iii*), the system must be able to project and account for the changes in the operating situation at the very least until the disruption has concluded (i.e. projecting horizon). Therefore, implementing considerations *iii*) and *iv*) on equation 12.21, the calibrating time t_{cal} can be derived.

Initially, by replacing equation 12.21 in equation 12.20, the slope of the resulting linear function can be established. The slopes for a linear conflict severity weighting function can be expressed as a function of the estimated disruption length t_{EDL} and the calibrating time t_{cal} . Figure 12.4 provides a summary of the slopes of a series of resulting linear conflict severity functions derived for estimated disruption lengths t_{EDL} equal to 60, 90, 150, 180, 210 and 240 minutes and utilizing seven different calibrating times t_{cal} . The maximum disruption length being assessed is $t_{EDL} = 240 \text{ min}$, since this value already doubles the average disruption length of 1.8 hours detailed by Jespersen-Groth et al. (2009, p. 400).

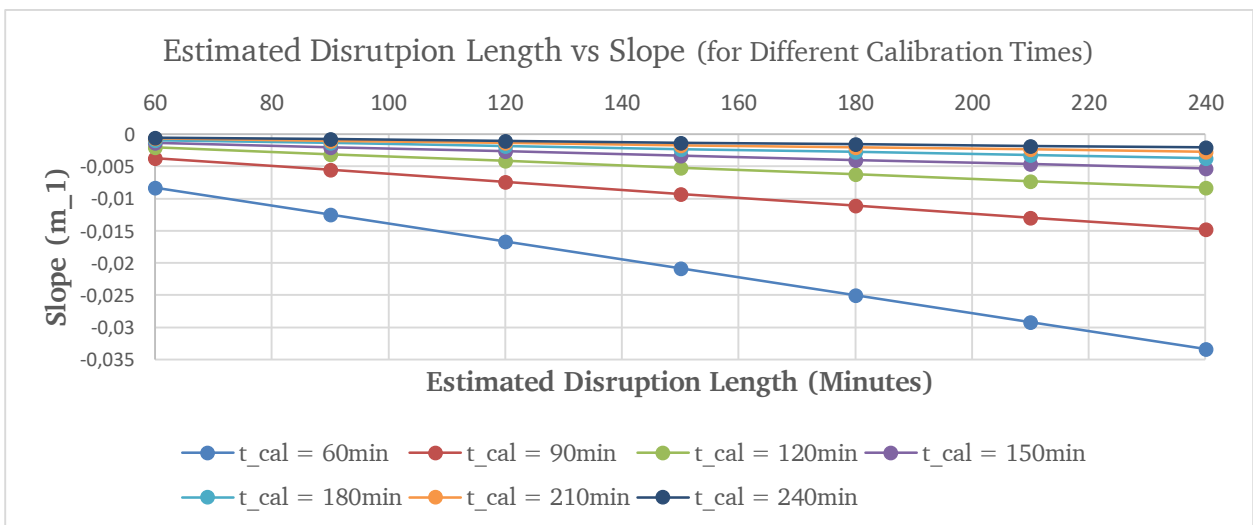

Figure 12.4 Changes in the slope of different linear conflict severity weighting functions for different disruption lengths and calibrating times (by author)

From figure 12.4, it is possible to appreciate there is a substantial difference in the slopes of the linear function between a calibrating time of 60 minutes against a calibrating time of 120 minutes or 180 minutes. For example, if the calibrating time is equal to 60 minutes and the disruption length is estimated as 120 minutes (average length – see Jespersen-Groth et al. 2009), the slope m_1 would be equal to -0.017. On the other hand, utilizing a calibrating time of 120 min for the same disruption length (i.e. 120 minutes), the slope m_1 would be equal to -0.004. Furthermore, abiding with consideration *iii*), the linear functions should be able to account for the severity of conflicts at least within the estimated duration of the disruption (i.e. projecting horizon). Therefore, the x-intercept of the linear function derived from different calibrating times becomes essential. By ascertaining the x-intercept for the worst case being considered (i.e. a disruption length $t_{EDL} = 240 \text{ min}$), the severity of the conflicts cannot cover the full length of the estimated disruption length for calibrating times t_{cal} below 180 minutes. For example, utilizing a calibrating time t_{cal} of 60 minutes, the severity of the conflicts for a distance of $t_{Dis_{c_f-c_f^{U.C}}}$ equal to 30 minutes, would already be equal to 0 (i.e. the x-intercept).

As a result, in case of the dynamic DRP deployment system, the calibrating time t_{cal} is recommended to be equal to 180 minutes since it would allow deriving a linear function that allows to account for above-average disruption lengths and still provide an increase in the slope for longer disruption lengths. For example, if the calibrating time t_{cal} is equal to 180 minutes and the disruption is estimated to last 120 minutes (i.e. average length), for a temporal distance between conflicts $t_{Dis_{c_f-c_f^{U.C}}}$ equal to 60 minutes, the conflict severity would be weighted as 0.89.

The second alternative is constituted by a negative exponential function, as depicted in figure 12.3 and generalized in equation 12.22. In this case, the weighting function contemplates an exponential decay in the weight of the ascertained conflict severity as a function of the temporal distance between conflicts $t_{Dis_{c_f-c_f^{U.C}}}$.

$$\varphi \left(t_{Dis_{c_f-c_f^{U.C}}} \right) = e^{(m_2 * t_{Dis_{c_f-c_f^{U.C}}})} \quad (12.22)$$

As with the slope in the linear function, the parameter m_2 must be calibrated within the framework introduced by the six considerations made in previous paragraphs. In this case, the calibration is also guided by the time $t_{0.5}$. The means to determine the parameter m_2 and further support its subsequent calibration is detailed in equation 12.23.

$$m_2 = \frac{\ln(0.5)}{t_{0.5}} \quad (12.23)$$

Establishing the time $t_{0.5}$ follows the same principles as the ones discussed for the linear function. The value can be introduced manually in correspondence to the local requirements or ascertained by means of equation 12.23. To facilitate the comparison between the proposed linear function, the same input values are utilized. Therefore, for the recommended t_{cal} equal to 180 minutes, a disruption which is estimated to last 120 minutes and a temporal distance between conflicts $t_{Dis_{c_f-c_f^{U.C}}}$ equal to 60 minutes, the conflict severity would be weighted by 0.86. Nonetheless, the benefit of the exponential function is that due to its change in slope it is able to cover any disruption length regardless of the calibrating time being utilized. Therefore, to abide with consideration *iv*), the calibrating time t_{cal} can be reduced from the 180 minutes recommended for the linear function up to 120 minutes. It is not recommended that the calibrating time t_{cal} is reduced beyond 120

minutes since the weight of the conflict severity for a temporal distance near the end of a disruption in the considered worst-case scenario (i.e. disruption lengths approaching 240 minutes) would tend to 0.

Due to the proposed structure of the weighting functions, the linear function would give a higher weight to the conflict severity until $t_{0.5}$. Beyond $t_{0.5}$ the linear function would continue a systematic decay until it intercepts the X-axis. On the other hand, the change in slope in the exponential function would allow supporting a much milder change in weight of the conflict severity's relevance (see figure 21.3). Therefore, due to the flexibility with which the exponential function can fulfill the six consideration made above, the dynamic DRP deployment system utilizes as standard approach the proposed exponential function to support weighting the ascertained conflict severity as a function of the temporal distance between conflicts $t_{D_{c_f-c_f^{u.c}}}$.

$$DV_2 = \sum_1^{c_{f'}} \left(SE_{c_{f'} RS_{c_f}^y} \right) * \varphi \left(t_{Dis_{c_{f'}-c_f^{u.c}}} \right) - \sum_1^{c_f} \left(SE_{c_f} \right) * \varphi \left(t_{Dis_{c_f-c_f^{u.c}}} \right) \quad (12.24)$$

Ultimately, equation 12.24 can be modified to include the means to weight the ascertained conflict's severity in correspondence to its temporal distance to the conflict addressed by conflict resolution alternative under consideration $RS_{c_f}^y$.

Summary

The approach proposed in this subsection supports the evaluation of the change in the projected operating situation as part of the dynamic DRP deployment system. The resulting determining variable allows assessing the induced changes in the projected operating situation by a prospective implementation of a conflict resolution alternative (i.e. look-ahead capability), relying on the framework introduced in subsection 11.3.2.

Finally, considering further requirements of dynamic DRP deployment system, namely, ensuring the transition to stable operations, the weighting function proposed in this subsection can be specially calibrated for all potentially queuing trains before the LtfTS (see subsection 10.5). For this purpose, the calibrating time of the weighting function can be adjusted to provide a much milder decline in the weight of the conflict severity, for example, utilizing a calibrating time t_{cal} of 150 minutes or 180 minutes instead of the 120 minutes recommended for the exponential function.

12.3.3.EP3 – Changes of Platform Tracks

This determining variable concentrates on evaluating the changes of platform tracks in every conflict resolution alternative $RS_{c_f}^y$ being put forward in the previous module (section 11). As advanced within the existing approaches, the changes of platform tracks have a strong influence on the passengers' perception regarding the quality of the operations. Therefore, this subsection details the establishment of an evaluation approach that can be conducted from a temporal point of view in such a way that is representative of the influence on the affected passengers at the stations, as established by the requirements of the system (see subsection 3.4.2).

As discussed in subsection 12.2.1, existing approaches that evaluate the changes of platform tracks do so by introducing a calibrated time equivalent penalty value or malus. This penalty value is calibrated as a function of the model train, its priority, and distinguishing between a change of the

platform track to an entirely different platform versus a simple change to a different edge of the same platform (see subsection 2.2.3). Sulyok (2018), on the other hand, recommends the utilization of a different and less subjective approach to assessing the changes of platform tracks. The proposed assessment relies on the platform exchange time for passengers (see subsection 3.6.2) at the affected station as an alternative attribute.

As a result, two different approaches for the determining variable can be recognized. On the one hand, the determining variable as a calibrated time equivalent penalty value, and on the other hand, the determining variable based on operational attributes that may not require to be calibrated to be time equivalent.

Deriving the evaluation framework to assess the determining variable as a generalized penalty value for the whole system entails that the evaluation parameter can be uniformly assessed at any point in the system without any further modification. Nonetheless, this approach requires additional context-dependent steps to conduct the calibration in correspondence to the system's implementation environment. Alternatively, the determining variable may be evaluated by an operational attribute that utilizes context-specific attributes (e.g. the platform exchange time for passengers), which would inherently support a much more objective assessment. However, this approach requires access to additional information, which must be gathered before the system can perform the evaluation.

The disadvantages of assessing the platform track changes by means of a generalized penalty value, as foreseen in existing approaches, can be summarized in two aspects. First, a penalty value that is calibrated depending on the model train or the train priority would not only be subjective but would result in a rigid structure that is applied generally without taking into consideration the context-specific circumstances. Second, the calibration of the penalty values in existing approaches is conducted as a function of the model train or its priority (see subsection 2.2.3), which would inherently assume that passengers utilizing different train services are influenced by the measure in different ways. This assumption is not necessarily valid. It must be considered that passengers who utilize long-distance or express services may also need to utilize a commuter or regional service on the same trip to reach a transference location or final destination.

Depending on the computational effort available, a calibrated time equivalent attribute can be utilized as the least complicated approach. However, in order to support the general validity of the dynamic DRP deployment system and the fulfillment of its requirements (see subsection 3.4.2), the determining variable for the change of a platform track is advanced so as to incorporate the minimum platform exchange time for passengers ($\min t_{P.Ex.}$) in its evaluation structure. Therefore, considering the implementation process of the dynamic DRP deployment system and the relevance of passengers' perception in the evaluation, a change in the platform track is evaluated by distinguishing between two different instances.

- i) The change of platform track cannot be communicated to the passengers on time: in this case, the influence is particularly detrimental to the passengers' welfare since they are not able to react on time to the operational changes. Here, the system's deployment time $t_{0,TD}$, as well as the minimum communication time $\min t_{Comm}$ acquire an important role. Therefore, if the minimum communication time to the passengers $\min t_{Comm.Pass}$ plus the minimum platform exchange time for passengers $\min t_{P.Ex.Pt_{S_a}-Pt'_{S_a}}$ from the origin platform track Pt_{S_a} to the objective platform track Pt'_{S_a} is larger than the difference

between projected departure time $t_{Proj.Dep}^{S_a}_{T_{l_s,i}}$ of the affected train from the station S_a where the platform track has been changed and the system's deployment time $t_{0,TD}$, the platform track change cannot be communicated on time. This relation has been generalized in equation 12.25.

$$t_{Proj.Dep}^{S_a}_{T_{l_s,i}} - t_{0,TD} < \min t_{P.Ex.Pt_{S_a}-Pt'_{S_a}} + \min t_{Comm.Pass} \quad (12.25)$$

It must be noted that the minimum communication time to passengers is not the same as the minimum communication time ($\min t_{Comm} \neq \min t_{Comm.Pass}$). As discussed in subsection 2.3.3, once an operational decision has been made, it is first relayed to the relevant staff members. Ultimately, the staff communicates the necessary information to the passengers - in this case, at the stations. Thus, the communication time to passengers stands at the end of the communication chain.

- ii) The change of platform track can be communicated to the passengers on time: in this case, the effects of the change are not as detrimental to the passengers' welfare. Therefore, by modifying equation 12.26 accordingly, the ability to communicate the change of platform can be ascertained.

$$t_{Proj.Dep}^{S_a}_{T_{l_s,i}} - t_{0,TD} \geq \min t_{P.Ex.Pt_{S_a}-Pt'_{S_a}} + \min t_{Comm.Pass} \quad (12.26)$$

The change of a platform track for every affected train $T_{l_s,i}$ within a conflict resolution alternative $RS_{C_f}^Y$ is evaluated depending primordially on the minimum platform exchange time for passengers and the ability to communicate on time the changes of platform tracks to the passengers. The passenger platform exchange time $t_{p.Ex.T_{l_s,i}}^{Pt'_{S_a}}$ between the origin platform track Pt_{S_a} to the objective platform track Pt'_{S_a} is ascertained as in equation 12.27, taking into consideration the two instances detailed above.

$$t_{p.Ex.T_{l_s,i}}^{Pt'_{S_a}} = \begin{cases} \min t_{P.Ex.Pt_{S_a}-Pt'_{S_a}} + \left(\min t_{P.Ex.Pt_{S_a}-Pt'_{S_a}} + \min t_{Comm.Pass} - \left(t_{Proj.Dep}^{S_a}_{T_{l_s,i}} - t_{0,TD} \right) \right), & \text{if } i) \\ \min t_{P.Ex.Pt_{S_a}-Pt'_{S_a}}, & \text{if } ii) \end{cases} \quad (12.27)$$

All in all, if the change of the platform track can be communicated on time, the determining variable takes into account only the minimum platform exchange time for passengers $\min t_{P.Ex.Pt_{S_a}-Pt'_{S_a}}$ between the platforms. The temporal magnitude of the attribute would inherently consider the fact a platform track has been exchanged either to a different platform or simple to another edge of the same platform. Ultimately, if the change cannot be communicated in time, the determining variable considers an additional penalty, which takes into account the magnitude of the temporal misalignment between the minimum platform exchange time, the communication time and the train's departure from the station.

As a result, to evaluate the changes in platform tracks, the passenger exchange time between platforms $t_{p.Ex.T_{l_s,i}}^{Pt'_{S_a}}$ for all affected trains can be aggregated. The evaluation of the determining variable is generalized in equation 12.28, which penalizes the platform track changes in the conflict resolution alternative by aggregating the passenger exchange time between platforms (see equation 12.27) for all platform changes and affected trains.

$$DV_3 = \sum_i \sum_a t_{p.Ex.T_{LS,i}}^{Pt's_a} \quad (12.28)$$

The above-explained approach can only be implemented if values for the minimum platform exchange time for passengers are available for every station. This information can be handled as a station-specific matrix of minimum platform exchange times for all passengers between every platform track utilized for passenger exchange. Since this information is often not available on infrastructure models focused on managing operations, its availability in the system must be preemptively guaranteed. However, if the information is not available, generic passenger exchange values can be established by following the differentiation of an exchange between entire platforms or only edges of the same platform.

12.3.4.EP4 – Cancelled Train Services

The determining variable discussed in this subsection concentrates on assessing the cancellation of train services within the conflict resolution alternatives $RS_{C_f}^y$ developed in section 11. As part of the dynamic DRP deployment system, the cancelled train services have been identified as service conflicts, clustered to account for all affected stations and resolved by transferring the passengers' waiting time at the respective stations. Following this approach, transferring passengers' waiting time to a subsequent train service is the only conflict resolution alternative that can be generated to address and trace the cancellation of train services (see subsection 6.3.13). This subsection discusses and derives a determining variable to assess the conflict resolution alternatives that are developed by the CDCR process to address every positively identified service conflicts during the fixing process of the PVSCS combination.

At the outset, a summary of the handling of train service cancellations would allow establishing the evaluation structure to assess the determining variable. Within the CDCR process, the cancellation of train services is handled through an identification of service conflicts (see subsection 3.5.2). These train services may have been cancelled either totally, partially, or at certain stations, as discussed in subsection 11.4.1. The identification of service conflicts is conducted not only after a conflict resolution strategy that foresees their cancellation has been chosen but also as a product of the implementation of the line-specific conflict solution alternatives utilized to develop the train's PVSCS included in the combination being assessed.

Moreover, to solve the service conflicts product of the cancellation of a train service throughout a given number of affected stations, the CDCR process implements the only elemental conflict resolution alternative, which is aimed at accounting for this particular conflict type (see subsection 6.3.13). The conflict resolution alternative has been structured from a passengers' perspective and involves the transference of their waiting time at every station where a service conflict has been positively identified. As discussed in subsection 6.3.13, this allows not only to account for the cancellation of the train service on the serviceability of the network but also to trace the cancelled train service. Since there is only one conflict resolution alternative being generated, the determining variable may be assessed by the already ascertained effect on the serviceability of the network.

Furthermore, it must be noted that service conflicts have also been utilized to complement the evaluation of changes in the projected operating situation. Their utilization within this determining variable allows to include any possible train service cancellations as part of the system's look-ahead capability (see subsection 12.3.2).

As discussed in subsection 12.2.2, to structure an evaluation approach, its ability to assess the effects of each developed conflict resolution alternatives on the operating situation of the network is essential. Moreover, the assessment must be able to express its results temporally or adjusted to be time equivalent, so that it can be compared with other determining variables. Therefore, different approaches can be put forward to evaluate the cancellation of train services. Possible approaches may be advanced along with an evaluation of the relative change in the number of stations reached by the train service (i.e. the number of affected stations versus stations still being serviced) and calibrate them as a time equivalent penalty value. However, while the evaluation approach to assess the determining variable can be structured from the bottom-up, the already existing an arguably robust approach supporting the handling of service conflicts may be considered.

The conflict resolution alternative to address the service conflicts generated by the cancellation of a train service provides a very detailed account of the effect on its users. Therefore, the foundation provided by the handling of the service conflicts focused on the passengers' welfare may constitute a robust framework to structure the determining variable. Furthermore, the main operational attribute being handled as the by-product of the conflict resolution alternative is the passengers' waiting time with a station-specific granularity; therefore, the considered attribute is already expressed temporally. Additionally, since the framework is already ingrained within the dynamic DRP deployment system's approach, it would add little to no further complexity.

Accordingly, the evaluation approach to assess the cancellation of train services builds upon the existing framework utilized to handle the identified service conflicts. As a result, the evaluation approach to assess the cancellation of train services utilizes the transferred passengers' waiting time generated in every affected station. The transferred passengers' waiting time is ascertained by taking into consideration the actual operating situation at each one of the stations in which the train service has been cancelled (see subsection 11.5.4). The key to this process is the identification of a prior and subsequent train services to determine the induced service interval and the magnitude of the transferred waiting time. Thus, it is possible to distinguish the scope of the induced passengers' waiting time for every station affected by the cancellation of the train service (see subsection 3.7.2 and 6.3.13). Ultimately, considering that the ascertained passenger's waiting time intends to reflect the affected passengers' welfare at the station (induced waiting time at the affected station for the next train service), it may not need to be affected by any weighting parameter.

At last, the evaluation approach can assess every conflict resolution alternative by simply adding the induced passengers' waiting time across all stations affected by the cancelled train service. The resulting evaluation structure of the determining variable is generalized in equation 12.29, where the passengers' waiting time $t_{PW,Q-R}^{S_a}$ at station S_a due to the cancelling of train service Q , which is transferred to a subsequent train service R , is added for all affected stations (see subsection 11.5.4).

$$DV_4 = \sum_{S_a}^{S_z} t_{PW,Q-R}^{S_a} \quad (12.29)$$

The above-explained approach can be implemented for the whole system without any restriction. Due to the detailed exploration of the operating situation induced by the cancellation of a train service throughout each of its affected stations, it supports a very detailed evaluation.

12.3.5.EP5 – Changes of Turning Stations

This determining variable concentrates on the changes of the turning stations assigned to trains as part of their PVSCS vis-à-vis the turning station foreseen by their lines' DRP operating concept. Overall, changing a train's turning station entails a transference of the operational burden (i.e. occupancy of the platform track used for turning the train) towards the host station, which may have also been directly affected by the cause of the disruption. Therefore, assessing the changes in turning stations stands as an essential complement for ascertaining the fitness of the PVSCS combinations. This subsection discusses the structuring of an evaluation approach that allows assessing the changes of turning stations within the PVSCS combination under consideration.

At the outset, assessing both the change of turning stations and the cancellation of train services allows taking into consideration modifications introduced in the planned route of a train. In consequence, it is necessary to emphasize the difference between these two determining variables.

On the one hand, the cancellation of a train service evaluates the inability of a train to reach one or more stations along its route due to: a deviation from its route and the partial or total cancellation of the train service (see subsection 12.2 and 12.3.4). Furthermore, train service cancellations are assessed through the framework provided by the handling of service conflicts, considering its effects on passengers' waiting time.

On the other hand, the changes on a train's turning station concentrate on the deviation of a train towards turning stations that are not at all foreseen in the DRP operating concept of their lines. Therefore, changes in turning stations occur as part of the exploration and consideration of the accessible infrastructural elements during the development of a train's PVSCS, as discussed in subsection 9.4. Therefore, while changes of turning stations that take place within the planned routes of the affected trains are evaluated within the CDCR process (e.g. after the implementation of an early turn to address a circulation conflict), the utilization of turning stations outside the network can only be ascertained by contemplating the specific PVSCS of every train in the PVSCS combination. Consequently, as detailed in the overall structure (see subsection 12.2), evaluating the changes of turning stations entails contemplating measures introduced at the line-specific level; thus, for the whole PVSCS combination.

The use of turning stations not foreseen in the DRP operating concept, particularly outside the commuter railway network and during a complete blockage, may allow a faster transition of the commuter railway network to transition to stable operations. However, the turning of the train would intrinsically have a negative effect on the capacity consumption in and around the host station. Therefore, this determining variable requires advancing an effective evaluation structure that allows assessing the operational burden transferred to the host station due to the unforeseen turning of trains at their platform tracks.

The evaluation structure of this determining variable can be arranged utilizing different approaches. One alternative is to follow a similar strategy as the one utilized in existing approaches assessing the changes in platform tracks (see subsection 12.2). Structured in this way, the evaluation of the determining variable results in a time equivalent penalty value that must be calibrated before it is generalized for the whole system. Another option is to consider the utilization of existing yet relevant operational attributes that may be expressed temporally (e.g. subsection 12.3.4). These parameters can be immediately generalized for the whole system and support a less subjective assessment of the changes in the turning station.

If selected, the first option requires the establishment and calibration of different time equivalent penalty values to support assessing the operational burden transferred to the host station. This approach may involve deriving single penalty values to account for as many operational attributes at the host turning station as possible. Conversely, as discussed in the structuring of previous determining variables (see 12.3.3 and 12.3.4), exploring different operational attributes that are aligned with the overall aim of the assessment and can be expressed temporally allows securing a more generalized and detailed evaluation of the operating situation.

The second approach would support the ability to cover a broader range of operating situations. Furthermore, it would also allow deriving an evaluation structure for the determining variable based on attributes that can be intrinsically expressed temporally, and if carefully selected, they do not need to be calibrated. Consequently, the second approach is chosen to evaluate the changes in turning stations within the PVSCS combination.

The resulting evaluation structure is detailed in the following subtitles. Initially, since it has not been explicitly established until this point, a detailed account of the process that allows identifying the changes in the turning station within each of the train's PVSCS in the combination must be established. Later, an evaluation structure based on operational attributes that are aligned with the overall aim of the assessment is derived and discussed in detail.

Identification of Changes in Turning Station

The changes in the turning stations of every train's PVSCS in the PVSCS combination have not been identified until this point. In order to support the evaluation of the changes in the turning station within the entire PVSCS combination, each of the train's PVSCS in the PVSCS combination under investigation must be assessed.

As discussed in section 7 and subsection 2.3.3, the actual location of trains in the network during the deployment of the DRP operating concept allows determining their ability to follow their line-specific DRP operating concept. As a result, any principles utilized to identify changes of turning stations cannot be uniformly applied across all the trains' PVSCS in the PVSCS combination.

In order to take into consideration the operating situation of every train in correspondence to its actual location in the network during the system's deployment time $t_{0,TD}$, the train clusters ascertained in subsection 7.3 may be utilized. Therefore, changes in the turning station on every train's PVSCS vis-à-vis its category can be identified in the three cases detailed below.

- i) *For Green+ and Red+ trains:* these trains drive away from the disruption and must reach their end stations before following their lines' DRP operating concepts. Thus, they should be able to reach any DRP relevant infrastructural or first-order element (see subsection 7.3). As a result, any turn foreseen in their PVSCS at turning stations not included in their line's DRP operating concept is acknowledged as a change in their turning station.
- ii) *For Green trains:* since these trains are able to follow their lines' DRP operating concepts, any turn in a station not foreseen in the DRP operating concept or along the route corresponding to its current train service, is acknowledged as a change in the turning station.
- iii) *For Yellow trains:* as discussed in subsection 2.3.3, these trains can not follow their affected lines' DRP operating concepts, yet they should be able to reach all the stations foreseen within their actual train service up to their end station (i.e. LtfTS during a complete blockage). Therefore, any turn conducted in a station not foreseen along the route

corresponding to its current train service is acknowledged as a change in the turning station.

Consequently, to identify existing changes in the turning station within the PVSCS combination, the train clusters of each of the affected lines must be incorporated (see subsection 7.3). As a result, the existence of changes in turning stations in the PVSCS $d_{T_{l_S,i}}$ of every train $T_{l_S,i}$ within the PVSCS combination $I_{S,o}$ under investigation, is established following the five steps detailed below.

1. All the PVSCS $d_{T_{l_S,i}}$ in the already fixed combination $I_{S,o}$ under investigation and the train categories for all the lines l_S are acknowledged.
2. Starting with PVSCS $d_{T_{l_S,i=0}}$, the next PVSCS $d_{T_{l_S,i+1}}$ in the combination $I_{S,o}$ is selected.
 - If there are no more PVSCS $d_{T_{l_S,i}}$ in $I_{S,o}$, the identification process of the changes in turning stations is terminated.
3. The train cluster in which train $T_{l_S,i}$ can be found is established by examining all train clusters $\{R + l_S, G + l_S, Y_{l_S}, G_{l_S}\}$ of its respective line l_S .
4. The turning station TS_a utilized to turn the train in the current $d_{T_{l_S,i}}$ is established.
5. The turning station TS_a utilized to turn the train in the current $d_{T_{l_S,i}}$ is compared to the turning station as defined by the three cases detailed above with the aid of the infrastructural elements established in subsection 5.3 for every line.
 - If the TS_a is not compatible with the principles detailed in the respective case, the turning station, specifying the platform track Pt_{S_a} and the additional turning train $T_{l_S,i}$, is included in a temporal set of differing stations $TS_{I_{S,o}}^{dif}$ for the combination $I_{S,o}$. The process can return to step 2.
 - If the TS_a is compatible with the principles detailed in the respective case, the process returns to step 2.

Ultimately, all the turning station changes for the combination $I_{S,o}$ have been established in the temporal set $TS_{I_{S,o}}^{dif}$.

Structuring of the Determining variable for Changes in the Turning Station

The changes in the turning station are evaluated for all PVSCS $d_{T_{l_S,i}}$ in the combination registered in $TS_{I_{S,o}}^{dif}$, as established by the process described in the previous subtitle. In this subtitle, the evaluation structure of the determining variable to assess the operational effects of changing a train's turning station is derived and discussed.

As it has already been established in subsection 12.2, the structured approach calls for the consideration of existing operational attributes, which may be expressed temporally. Overall, the objective of assessing the changes in turning stations is to ascertain the operational burden which has been transferred to the host turning station by the unforeseen turning of one or multiple trains at their platform tracks. Therefore, to evaluate the transferred operational burden induced by an unexpected utilization of a platform track at a host turning station, two attributes as potential alternatives may be taken into consideration.

-
- i) The first alternative focuses on assessing the induced waiting time (i.e. change in delay) for all trains directly affected by the unforeseen turning of a train at the platform track in the host station.
 - ii) The second alternative focuses on assessing the consumed capacity by the unforeseen turning of a train at a platform track in a host station and its effects on the quality of service (see subsection 2.2.4).

The first alternative would entail establishing the induced relative-time change across all directly affected trains product of an additional turning of a train at the platform track in the host station (see subsection 12.3.1). Ascertaining this attribute entails the identification of the induced waiting time (i.e. consecutive delay) for all affected trains at the host station; thus, supporting a very accurate and detailed assessment of the operational burden being transferred to the host station. To derive the evaluation structure of the determining variable focused on the assessment of this attribute, the operating information from other types of railway traffic and other railway companies is of critical importance (see subsection 5). If this information is available and since at this point the PVSCS combination would have been completely fixed (i.e. conflict-free), the induced waiting time throughout all affected trains can be accurately ascertained for every element in $TS_{I,S,o}^{dif}$. The waiting times in each case may be acquired by identifying and isolating the induced relative-time changes of all trains at the host station affected by the additional turning of trains registered in $TS_{I,S,o}^{dif}$ and aggregate them into one single value. Nevertheless, employing this attribute to derive the evaluation structure of the determining variable would render the assessment highly dependant on the availability of the operating information from other types of railway traffic and other railway companies (see subsection 5).

The second alternative contemplates assessing the capacity consumption by the turning of additional trains at a platform track in the host station and reflecting this on the quality of service. Different approaches may be utilized to assess the capacity consumption of an infrastructural element and place it in the context of its quality of service (see subsection 2.2.4). Since the extent to which the operating information of other railway traffic available cannot be guaranteed, possible approaches, which are carried at the scheduling level, may be utilized to circumvent this issue. While using these approaches would limit the accuracy of the assessment, particularly when compared to the one that can be achieved by the first alternative, it would still allow the system to carry out the assessment regardless of the availability of the operating information of other types of railway traffic.

From the two alternatives discussed above and considering that the system already counts with an evaluation approach to conduct the assessment (see subsection 12.3.1), the first alternative would be the option that introduces the least complexity and burden to the overall system. Structuring the evaluation around the induced waiting times would secure an evaluation with sufficient accuracy through a simple structure. However, since the availability of the information regarding other types of railway traffic cannot be guaranteed, a more robust approach should need to be secured. Therefore, to derive the evaluation structure of the determining variable as part of the requirements and limitations of the dynamic DRP deployment system (see subsections 3.3.2 and 3.4.2), the capacity consumption of the platform track utilized to turn the train in the host station and its effect on the quality of service are the recommended as the standard approach to assess the changes in turning stations.

Two approaches may be considered to evaluate the performance (i.e. the capacity consumption) of a given infrastructural element at the scheduling level. The first approach is advanced along with the constructive method detailed in the UIC Code 406 (2013), which has been briefly discussed in subsection 2.2.4. The second approach is an analytical method based on the work of Schwanhäußer (1974) and queuing models, which has also been briefly introduced in subsection 2.2.4.

Both of the approaches are discussed next, and ultimately, one is selected as the standard evaluation approach to assess this subsection's determining variable.

First approach – Constructive Method

The first approach is based on the compression method detailed in the UIC Code-406 (UIC 2013, p. 28) for platform tracks within a node. The method allows ascertaining the capacity consumption for every individual platform track, as introduced in subsection 2.2.4. Overall, the capacity consumption of a platform track is calculated by ascertaining the share of the occupancy time of all trains scheduled to occupy the platform track within a defined time period. Additionally, under this method, time rates must be added to the occupancy time of all trains. The values for the additional time rates have been detailed in table 2.2.

The necessary input variables must be first established to implement the existing method as part of the dynamic DRP deployment system's framework, namely, the occupancy time of all trains, a defined time period and the additional time rates.

Initially, it must be considered that at this juncture, the PVSCS combination under investigation would be already conflict-free (see subsection 12.2). Therefore, the arrival and occupancy time of every train registered in $TS_{I_s,o}^{dif}$ are immediately available for their utilization. Likewise, the occupancy time of all trains that are scheduled to utilize the platform track within the defined time period may be acquired from the host station's original schedule. The defined period of time t_{def} may be appointed depending on the actual implementing field. However, in order to cover all potential train services within the peak hour, it is recommended that the defined time period t_{def} is not assigned a length of less than 240 min (4 hours) from the moment the system is being deployed $t_{0,TD}$ (see subsection 2.2.4).

Therefore, by acknowledging all train services scheduled to utilize the platform track within a defined time period t_{def} of 240 min and adding the occupancy time of the train registered in $TS_{I_s,o}^{dif}$, the occupancy time of all trains can be ascertained.

The occupancy time t_z^T of the platform track Pt_{s_a} for every train T is ascertained as supported by the infrastructural model (see equation 11.3; subsection 11.4.1). The occupancy time for all trains scheduled to utilize the platform track within the defined time period and including the additional train can be ascertained as generalized in equation 12.30. Overall, the occupancy time of the platform track must distinguish if the trains which are foreseen to utilize the platform track either stop, drive through the station without a stop or conduct a transition between train services. The transition between train services inherently includes the turning of the additional or any other train, and any coupling or decoupling operation that is conducted at the platform track under consideration (see subsection 11.4).

$$t_Z^{Pt_{sa}} = \sum_T t_Z^{Pt_{sa}} \quad (12.30)$$

As a result, the capacity consumption of the platform track at the host station can be ascertained by means of equation 2.13 (see subsection 2.2.4). To support its implementation in the dynamic DRP deployment system, equation 2.13 is generalized as detailed in equation 12.31, where an additional time rate of 100% from table 2.2, is implemented.

$$\rho^{Pt_{sa}} = \frac{t_Z^{Pt_{sa}} * 2}{t_{def}} \quad (12.31)$$

Equation 12.31 allows ascertaining the capacity consumption of a platform track $\rho^{Pt_{sa}}$ at the host station by dividing the occupancy time for all trains $t_Z^{Pt_{sa}}$, which is multiplied by the additional time rate, through the defined time period t_{def} . By introducing an additional time rate of 100%, the occupancy time is multiplied by 2 (see equation 2.13).

Finally, the resulting $\rho^{Pt_{sa}}$ must reflect its influence on the quality of service after including the turn of an additional train at the platform track. Under this method, the quality of service is considered through recommended standardized limit values for the concatenated capacity consumption ρ_{Lim} . The standardized values have been detailed in table 2.3 in subsection 2.2.4 separately for switching zones and platform track. The recommended limit values for the capacity consumption in platform tracks are between 0.4 and 0.5.

The establishment of the determining variable's evaluation structure based on the assessed attribute concludes with a contrast of the induced effects in the capacity consumption product of the unforeseen turning of the train in the host station against the recommended limits. Therefore, if a value of $\rho_{Lim} = 0.5$ is utilized as the threshold, any assessed capacity consumption values $\rho^{Pt_{sa}}$ that falls within the threshold can be penalized differently as those that surpass the threshold. However, it must be considered that within the current method, any capacity consumption under 1 would entail that there is still available capacity, and no queue is being generated. Therefore, since the assessment is conducted within the context of disrupted operations, depending on the relevance of the station and the quality of service that wants to be upheld, values until $\rho_{Lim} = 1$ are still be considered acceptable.

The first approach would allow deriving an evaluation structure that inherently takes into consideration the magnitude of the additional train's turning time at the platform track in the host station. However, the approach has one significant limitation. Due to the lack of operating information regarding other types of railway traffic, the actual arrival time and departure times of the trains at the platform track remains only a conjecture. Since the approach is founded over a constructive method, the uncertainty regarding the arrival and departure time of a train at the platform track would broadly limit its use. The inaccuracy produced by conducting the assessment with only one train may be tolerated. However, if more than one train is to be added simultaneously, the actual arrival time of the train becomes essential for the compression of the schedule.

Second approach – Analytical Method

As in the constructive method, the second approach also allows taking into consideration all train services that are scheduled to utilize the platform track in the host station; however, in this case, the train order is no longer relevant and replaced by principles advanced within queuing models.

As discussed in subsection 2.2.4, queuing models are based overall on mean service times \bar{t}_B and mean inter-arrival times \bar{t}_A with their respective coefficients of variation, both as a function of the capacity consumption ρ .

To implement the existing method as part of the dynamic DRP deployment system's existing framework, the necessary means to ascertain the capacity consumption must be established. The means to acquire the capacity consumption ρ within the queuing model have already been discussed in subsection 2.2.4.

The capacity consumption for a single-channel waiting system, as it is assumed to be the platform track under consideration, can be ascertained as in equation 2.14 (see subsection 2.2.4). The platform tracks can be assumed as a single-channel waiting system as no more than one train can occupy it at the same time. The equation is generalized to support its implementation within the dynamic DRP deployment system, as detailed in equation 12.32.

$$\rho^{Pt_{s_a}} = \frac{\lambda}{\mu} \quad (12.32)$$

Equation 12.32 derives the capacity consumption at the platform track Pt_{s_a} in question by dividing the arrival rate λ by the service rate μ .

Since the analysis is carried out at a station located anywhere in the network outside the commuter railway system where different types of railway traffic are handled, it may be assumed that there are multiple access routes to the infrastructural element in question. In this regard, the inter-arrival times can be considered exponentially distributed with a variation coefficient of 1. Therefore, the arrival rate λ at the platform track can then be ascertained as in equation 12.33.

$$\lambda = \frac{r_T}{t_{def}} \quad (12.33)$$

Equation 12.33 derives the arrival rate λ by dividing the total number of trains r_T foreseen to utilize the platform track under consideration within the defined time period t_{def} . As discussed in the previous approach the number of trains r_T scheduled to utilize the platform track within the defined time period may be acquired through the host station's original schedule. In order to cover all potential train services within the peak hour, it is recommended that the defined time period t_{def} is not assigned a length of less than 240 min (4 hours) (see subsection 2.2.4). The number of trains can be complemented by all additional trains registered in $TS_{Is,o}^{dif}$ and that are expected to utilize the platform track Pt_{s_a} at the host turning station. Together the scheduled and additional trains constitute the total number of trains r_T foreseen to utilize the platform track within the analysis.

Furthermore, the service rate can be ascertained as the inverse of the mean service time (see subsection 2.2.4). In this case, the mean service time \bar{t}_B constitutes the mean occupancy time $\bar{t}_Z^{Pt_{s_a}}$ of all the trains that are expected to utilize the platform track Pt_{s_a} under consideration. Equation 12.34 generalizes the means to ascertain the service rate μ as part of the dynamic DRP deployment system.

$$\mu = \frac{1}{\bar{t}_Z^{Pt_{s_a}}} \quad (12.34)$$

As discussed in the previous method, the occupancy time $t_{Z T}^{Pt_{S_a}}$ of the platform track Pt_{S_a} for every train T is ascertained as supported by the infrastructural model and distinguishing between stopping, non-stopping, and trains that conduct a transition between train services (see equation 11.3). To ascertain the mean occupancy time $\bar{t}_Z^{Pt_{S_a}}$ for all trains foreseen to utilize the platform track, slight modifications are introduced to equation 12.30.

$$\bar{t}_Z^{Pt_{S_a}} = \frac{\sum_T t_{Z T}^{Pt_{S_a}}}{r_T} \quad (12.35)$$

Equation 12.35 permits to ascertain the mean occupancy time $\bar{t}_Z^{Pt_{S_a}}$ of the platform track in question by dividing the sum of the occupancy time of the platform track of every single train foreseen to occupy the platform track within the defined time period by the total number of trains r_T .

As a result, merging equations 12.35 with 12.34 in equation 12.33, the capacity consumption of the platform track $\rho^{Pt_{S_a}}$ at the host station under consideration can be ascertained by means of equation 12.36.

$$\rho^{Pt_{S_a}} = \frac{\bar{t}_Z^{Pt_{S_a}} * r_T}{t_{def}} \quad (12.36)$$

Ultimately, to reflect the influence of the ascertained capacity consumption on the platform track's quality of service, the principles discussed in Schwanhäuser (1974) acquire particular importance. As discussed in subsection 2.2.4, the effects on the quality of service can be reflected directly on the number of trains occupying the infrastructure, where the higher the number of trains, the higher the sum of unscheduled waiting times that are induced during the operating process (see figure 2.4). In figure 2.4, a limit is reached where the induced waiting times due to the introduction of additional trains tend to infinity (Hansel and Pachl 2014). In terms of the capacity consumption, by turning additional trains in the platform track, the unconsumed capacity initially available due to the pre-emptively foreseen buffer times would be utilized. The utilization of this capacity would, in turn, affect the quality of service and the sum of unscheduled waiting times being generated (Schwanhäuser 1974). Therefore, the ascertained or induced capacity consumption can be put in relation to the remaining capacity after including the turning of the additional trains to evidence the effects on the remaining buffer time t_p . The ascertained or induced capacity consumption can be put in relation to the residual capacity, as generalized in equation 12.37 (see Schwanhäuser 1974, p. 49, 78).

$$\frac{\bar{t}_Z^{Pt_{S_a}} * r_T}{t_p} = \frac{\rho^{Pt_{S_a}}}{1 - \rho^{Pt_{S_a}}} \quad (12.37)$$

Consequently, equation 12.37 allows ascertaining the effect on the quality of service induced by the turning of the trains in the platform track at the host station. Aligned with figure 2.4, figure 12.5 provides an overview of the operational burden shifted to the platform track at the host station, by depicting the effects in the capacity consumption (originally available vis-à-vis induced) after turning the additional trains in the platform track. In the figure, as the induced capacity consumption approaches to 1, the relation between induced capacity consumption and the remaining capacity would tend to infinity.

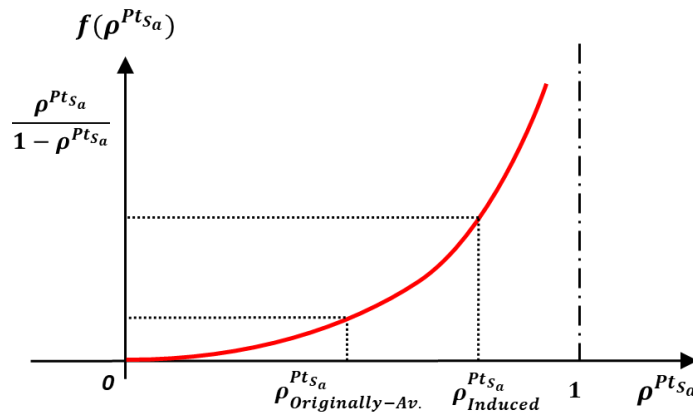

Figure 12.5 Induced changes in capacity consumption (by author)

The above-discussed approach supports assessing the capacity consumption at platform tracks in the host station and the effect this has on the quality of service after foreseeing the turn of one or more trains that have had their original turning station changed.

Structure of the Evaluation Function

Depending on the implementing field of the system, each of the approaches introduced in this subtitle can be utilized to assess the capacity consumption to evaluate the changes in turning stations. However, a standard approach to finally establish the evaluation structure of this subsection's determining variable must be established. By taking into consideration the advantages and disadvantages of the proposed approaches and their ability to support the system's limitations and requirements, one of the approaches to evaluate the changes in turning station must be selected.

The constructive approach takes into consideration the order of the trains as they occupy the platform track under investigation. The order and the occupancy time of the trains utilizing the platform track is ascertained from the schedule and complemented with information from the additional train(s) contained in the set $TS_{I_{S,o}}^{dif.}$. While the information in the schedule (under consideration that the operating information from other types of railway traffic and other railway companies is not available) allows computing the capacity consumption of the platform track, the results may have limited relevance. This is because the arrival and departure time of trains from the investigated platform track due to any conflict between trains, which might occur as additional or scheduled trains access and leave the turning train station where the platform track is being investigated, may lead to a potential change in the assessed train order and the total occupancy time. As discussed in subsection 2.2.4, the analytical approach does not require a constructed schedule. Therefore, any changes in the train order due to potential conflicts are not as relevant, as for the constructive approach. Due to the additional robustness of the analytical approach regarding a possible system limitation, it is recommended as the standard approach to assessing changes in turning stations within the dynamic DRP deployment system.

To evaluate the effects of the operational burden shifted to the platform track at the host station, the initial operating situation at the platform track (i.e. scheduled) is subtracted from the induced operating situation (i.e. considering the additional trains) as generalized in equation 12.38. Initially, equation 12.38 ascertains the induced operating situation by computing the total occupancy time $t_{zT}^{Pt_{S_a}}$ of the platform track Pt_{S_a} in the host station S_a considering all trains $T_{I_{S,o}}$

(including the additional trains as established in the set $TS_{I_s,o}^{dif}$) within the defined time period t_{def} that is then multiplied by the relation between induced capacity consumption $\rho_{I_s,o}^{Pt_{S_a}}$ and the remaining capacity consumption (i.e. $1 - \rho_{I_s,o}^{Pt_{S_a}}$). Later, the initial operating situation, which it is computed analogically as the induced operating situation but only considering the trains foreseen in the schedule, is subtracted. Finally, the same must be conducted for every platform track Pt_{S_a} across the different host stations as established by the set $TS_{I_s,o}^{dif}$.

$$DV_5 = \sum_{Pt_{S_a} \in TS_{I_s,o}^{dif}} \left(\sum_{T_{I_s,o}} t_{Z T}^{Pt_{S_a}} * \left(\frac{\rho_{I_s,o}^{Pt_{S_a}}}{1 - \rho_{I_s,o}^{Pt_{S_a}}} \right) - \sum_{T_{Sched.}} t_{Z T}^{Pt_{S_a}} * \left(\frac{\rho_{Sched.}^{Pt_{S_a}}}{1 - \rho_{Sched.}^{Pt_{S_a}}} \right) \right) \quad (12.38)$$

Ultimately, the assessment of $\rho^{Pt_{S_a}}$ has been generalized in equation 12.38; however, to apply the framework within the evaluation structure, a specific case must be recognized. In cases where either due to the additional number of trains or the length of their projected occupancy time a capacity consumption higher than one (i.e. $\rho^{Pt_{S_a}} \geq 1$) is induced, the penalty must be given a value equal to $\rho^{Pt_{S_a}} = 0.999$. Under this consideration, the occupancy time of all trains would be severely penalized, rendering the respective PVSCS combination unfeasible.

Summary

In this subsection, a determining variable to assess the changes in the turning station within the PVSCS combination has been derived and detailed. The determining variable supports the assessment of the PVSCS combination under investigation, concentrating on the influence generated by the turning of trains on platform tracks at stations which are not foreseen in the DRP operating concept of their lines. These effects have been assessed by evaluating the induced capacity consumption of the platform track and its influence on the quality of service.

The evaluation structure for this section's determining variable has been entirely derived from the bottom-up. Different alternative approaches have been considered to establish the evaluation structure. In this regard, it has been decided to opt for considering different operational attributes that can be expressed temporally. Furthermore, a series of alternative attributes have been considered, and the alternative that would allow conducting the assessment regardless of the availability of information has been selected (i.e. information from other railway traffic operations). Finally, multiple approaches that would enable assessing the selected attributes have been put forward, and in due course, the alternative that better aligns with the system's requirements and limitations has been recommended to be utilized as the standard approach to assess. As a result, this section's determining variable focuses on evaluating the occupancy time of the platform track based on its influence on the induced capacity consumption after including the trains which have assigned a change of their turning station (see equation 12.38).

12.3.6.EP6 – End-of-Day Imbalances

This determining variable concentrates on assessing the end-of-day imbalance throughout all PVSCS in the combination that occurred due to the adjustment of the circulation plan. As discussed in subsections 2.2.3 and 2.3.2, dealing with the end-of-day imbalances is critical for supporting the scheduled operations of the railway network on the next day. This subsection details the

structuring of an evaluation structure for assessing any end-of-day imbalance within the PVSCS combination under investigation.

As discussed in subsection 2.3.2, the end-of-day imbalances are identified by conducting an end-of-day vehicle inventory on every line in the commuter railway network. The inventory is conducted at the end stations of all train services and registering every vehicle that finalized its duties at the investigated stations (see subsection 3.6.2). This information is compared to the original circulation plan of every vehicle or vehicle composition to establish the need to conduct any additional shunting movements and reallocate the vehicles that are not compatible with the operations scheduled for the next day.

While resolving the end-of-day imbalances is not in the scope of the dynamic DRP deployment system (see subsection 3.4.2), they are central to evaluate the effects of the adjustment of the circulation plan for each of the train's PVSCS in the PVSCS combination. Therefore, the assessment of the end-of-day imbalances must be supported to better reflect the actual fitness of the conflict-free PVSCS combination under investigation (see subsection 12.2.2).

Since the adjustment of the circulation plans is appointed during the development of the trains' PVSCS (see subsection 9.4.3), the end-of-day imbalance may be assessed for the whole PVSCS combination and not as the product of the vehicle-specific conflict resolution alternatives advanced in the CDCR process (see section 10). Moreover, as part of the dynamic DRP deployment system, the end-of-day imbalance may be engendered not only through the appointment of different transition train services but also through the implementation of line-specific elemental conflict solution alternatives (e.g. incorporating an external train). Therefore, it may be considered that there is a high probability that different vehicles within the selected trains' PVSCS would generate end-of-day imbalances as part of the PVSCS combination under investigation.

To structure the evaluation approach of this subsection's determining variable, the assessment must first support the identification of vehicles throughout all the affected lines that generate an end-of-day imbalance. Furthermore, since the dynamic DRP deployment system does not address this problem directly, the determining variable must not only allow an objective evaluation of the end-of-day imbalances generated by single vehicles but also consider the possibility that dispatchers may address this problem once the modified circulation plan as part of the conflict-free schedule has been implemented.

As discussed for the structuring of previous determining variables, two general approaches have been considered to establish the evaluation structure of the determining variable so that it is able to assess the operating situation from a temporal perspective. Namely, structuring it as a calibrated time equivalent penalty value or utilizing existing attributes that support a temporal evaluation of the operating situation. In this case, given the limitations of the system to solve the end-of-day imbalances, it would be complicated to structure and calibrate a time equivalent penalty value, despite its ability to reduce the complexity of the problem at hand. Therefore, conducting an exploration of existing attributes that can be utilized to assess the end-of-day imbalance would allow not only to generalize its evaluation but also provide a foundation to include a consideration of the dispatchers' capability to react to the engendered problem.

The evaluation structure of the determining variable is derived in the following subtitles. As with the change of turning station, the explanation starts by establishing a process to determine the vehicles that generate an end-of-day imbalance. Later, a discussion on the evaluation structure to assess the identified end-of-day imbalances is presented.

End-of-day Vehicle Inventory

As briefly explained in subsections 2.2.3 and 2.3.2, there are existing approaches that allow identifying vehicles that induce an end-of-day imbalance as a product of readjusting the circulation plan within a disruption (e.g. Nielsen et al. 2012). Furthermore, it is also argued that for determining the station in which each vehicle is projected to finalize its duties, the essential operational attributes are: an adjusted schedule and the disruption length.

In the case of the dynamic DRP deployment system, the already fixed PVSCS combination provides with the adjusted scheduled, whose circulation plans have already been established through an estimation of the disruption length as an input t_{EDL} (see subsection 9.5.2). Therefore, to establish the process that allows identifying the vehicles that generate an end-of-day imbalance, the approach relies on a projection where each vehicle is set to finalize its duties and where an end-of-day inventory must be conducted (see subsection 3.6.2).

Consequently, the end-of-day imbalance in every train's PVSCS is identified by conducting an end-of-day inventory, comparing the projected end station of every vehicle as established in the modified circulation plan, versus its originally scheduled end station. This approach relies on the input information recognized for every train, as discussed in 5.4.2.

As a result, for every train's PVSCS $d_{T_{l_s,i}}$ in the combination $I_{S,o}$ an end-of-day inventory is conducted, considering every single vehicle $\vartheta_{T_{l_s,i}}$ in the composition. The end-of-day inventory concentrates on every vehicle $\vartheta_{T_{l_s,i}}$ in the PVSCS $d_{T_{l_s,i}}$ and verifies three characteristics: the existence of an imbalance, the time in which the vehicle has started ($t_{SD,\vartheta_{T_{l_s,i}}}$) and finalized its duties ($t_{FD,\vartheta_{T_{l_s,i}}}$) and the parking location appointed to the vehicle. The process is conducted in the six steps detailed below.

1. All the PVSCS $d_{T_{l_s,i}}$ in the already fixed combination $I_{S,o}$ and the vehicles $\vartheta_{T_{l_s,i}}$ in the combination are incorporated.
2. Starting with PVSCS $d_{T_{l_s,i=0}}$, the next PVSCS $d_{T_{l_s,i+1}}$ in the combination $I_{S,o}$ is selected.
 - If there are no more PVSCS $d_{T_{l_s,i}}$ in $I_{S,o}$, the identification process of the end-of-day imbalances terminates.
3. For every $\vartheta_{T_{l_s,i}}$ in the vehicle combination, the station S_a in which the vehicle is projected to finalize its duties as detailed in the adjusted circulation plan and the station S_a' in which it is projected to finalize its duties as detailed in the original circulation plan are established.
 - If $S_a \equiv S_a'$, then no end-of-day imbalance is induced, and the process returns to step 2.
 - If $S_a \neq S_a'$, an end-of-day imbalance exists, and the process must continue to steps 4, 5 and 6.
4. The time at which in which the vehicle $\vartheta_{T_{l_s,i}}$ finalizes its duties $t_{FD,\vartheta_{T_{l_s,i}}}$ is recognized as the scheduled arrival time to the projected station S_a of the train, which contains the vehicle in its composition. The time at which the vehicle $\vartheta_{T_{l_s,i}}$ started its duties $t_{SD,\vartheta_{T_{l_s,i}}}$ is recognized as the scheduled departure time from the origin station of the first train service the vehicle was appointed to.

5. The parking location at which the vehicle must be shut down, as detailed in the original schedule, must also be recognized.
6. The time at which the vehicle $\vartheta_{T_{I_s,i}}$ finalizes and starts its duties as well as its parking location is stored in a temporal set $\vartheta_{I_s,o}$ that tracks the end-of-day imbalance for PVSCS combination $I_{s,o}$ under investigation. Later, the process must return to step 2.

Finally, all the vehicles that generate an end-of-day imbalance in the combination $I_{s,o}$ have been gathered in the temporal set $\vartheta_{I_s,o}$.

Structuring the Determining variable for the End-of-day Imbalances

With all the vehicles that generate an end-of-day imbalance in the combination $I_{s,o}$ positively identified and clustered in the set $\vartheta_{I_s,o}$, the evaluation can be conducted. Under the selected approach, the determining variable to assess the effects of having vehicles within the PVSCS combination that generate an end-of-day imbalance ought to be structured based on existing operational attributes. The attribute to be considered should be aligned with the aim of the determining variable, preferably expressed temporally, and reflect the capability of dispatchers to react to the engendered problem once has become manifest.

Considering that dispatchers still have the opportunity to address the end-of-day imbalances by implementing additional measures (see subsection 2.2.3), the evaluation structure can be advanced to reflect the last opportunity in which the situation may be addressed before it affects the operations on the next day. Therefore, one adept option might be to align the determining variable with the need to implement additional shunting movements to secure that all vehicles reach their scheduled parking location for their shutdown.

Following this approach, it is assumed that if no measures are implemented before the conflicting vehicles finalize their duties, an additional shunting movement would be the last option to guarantee the next day operations are not affected. To transform the need of an additional shunting movement into a temporal equivalent attribute, the journey time between the station S_a in which an affected vehicle is projected to finalize its duties (according to its adjusted schedule and circulation plan) and the parking location assigned by its original plan is proposed as an adept option. This value would provide an overview of the severity of the induced imbalance by reflecting the time a vehicle requires to reach its scheduled parking location. For example, if a vehicle finalizes its duties in a station close to its originally scheduled parking location, the penalty will be inherently milder than that of a vehicle that needs to traverse the entire commuter railway network to reach its parking location.

The benefit of the above-described approach is that it is based on an operational attribute (i.e. journey time) that can be generalized throughout the whole network and is inherently expressed temporally (i.e. journey time). However, since it assumes that no other measure has been taken until the last possible instant, it still needs to be complemented with the necessary means to account for any pre-emptive reaction on behalf of the dispatchers.

Whereas the journey time between the end station and the parking location of every vehicle in $\vartheta_{I_s,o}$ would secure a temporal equivalent attribute to evaluate the end-of-day imbalance; the means to account for any pre-emptive reaction on behalf of the dispatchers must still be established. The dispatchers' pre-emptive reaction may be accounted for by weighting the journey time between the end station and parking location. The weighting function φ can be calibrated to affect the

resulting journey (i.e. the additional shunting movement) time so that it reflects its probability of occurrence. This approach would inherently entail conducting a risk assessment, where the probability of occurrence of a particular event is multiplied by its related damage or cost.

As a result, equation 12.39 generalizes the evaluation of the effects introduced by the end-of-day imbalances on the PVSCS combination under investigation. The evaluation of the determining variable focuses on every vehicle $\vartheta_{T_{LS,i}}$ in the set $\vartheta_{LS,o}$ and relies on the journey time between the station S_a where the vehicle is projected to finalize its duties and its scheduled parking location to penalize the end-of-day imbalance. The journey time results from the difference between the projected departure $t_{Proj.Dep}^{S_a}_{\vartheta_{T_{LS,i}}}$ of the vehicle from the station S_a and the projected arrival of the vehicle to its scheduled parking location $t_{Proj.Arr}^{Parking}_{\vartheta_{T_{LS,i}}}$. Ultimately, the journey time is multiplied by a penalty value derived from a weighting function $\varphi(t_{FD,\vartheta_{T_{LS,i}}})$. The penalty value may be expressed as a function of the time in which the vehicle $\vartheta_{T_{LS,i}}$ finalizes its duties.

$$DV_6 = \sum_{\vartheta_{T_{LS,i}} \in \vartheta_{LS,o}} \left(t_{Proj.Arr}^{Parking}_{\vartheta_{T_{LS,i}}} - t_{Proj.Dep}^{S_a}_{\vartheta_{T_{LS,i}}} \right) * \varphi \left(t_{FD,\vartheta_{T_{LS,i}}} \right) \quad (12.39)$$

For the establishment and calibration of the weighting function $\varphi(t_{FD,\vartheta_{T_{LS,i}}})$ it is necessary to take into consideration the assumptions that guided the structuring of the determining variable. These assumptions can be summarized in two points:

- i) Dispatchers are able to implement further measures to tackle the generated end-of-day imbalance after the circulation plan has been adjusted.
- ii) The engendered end-of-day imbalances must be addressed in the last instance through the implementation of an additional shunting movement to direct the vehicle to its scheduled parking location after the finalization of its duties $t_{FD,\vartheta_{T_{LS,i}}}$.

Consequently, the penalty value derived from the weighting function can be advanced taking into account that the closer the moment in which the adjusted circulation plan comes in action to the moment the vehicle finishes its duties, the lower the probability that a dispatcher would be able to react and prevent the need for an additional shunting movement. In the case of the dynamic DRP deployment system, the moment in which the circulation plan has been adjusted would be somewhat equal to the system's deployment time $t_{0,TD}$. Thus, the weighting function is set to reflect the time in which a vehicle finalizes its duties $t_{FD,\vartheta_{T_{LS,i}}}$ vis-à-vis the time in which its circulation plan has been adjusted $t_{0,TD}$.

For the actual establishment of the weighting function, it remains necessary to recognize its boundaries and constraints following the considerations detailed above. Here, four events acquire particular relevance. First, the system's deployment time $t_{0,TD}$, as the time in which the circulation plan is modified. Second, the time in which the vehicle finalizes its duties $t_{FD,\vartheta_{T_{LS,i}}}$ within the framework of the adjusted circulation plan. Third, the time in which the vehicle started its duties $t_{SD,\vartheta_{T_{LS,i}}}$, as established by its original schedule. Finally, the disruption length t_{EDL} .

Having recognized these four events, it is possible to derive the weighting function boundaries and derive its constraints. Initially, the adjustment of the circulation plan of a vehicle can only take

place between the start $t_{SD,\vartheta_{T_{LS,i}}}$ and finish $t_{FD,\vartheta_{T_{LS,i}}}$ of its duties. Therefore, these values constitute the temporal boundaries of the considered problem. Moreover, the probability that an additional shunting movement needs to be implemented increases until $t_{FD,\vartheta_{T_{LS,i}}}$, where it becomes equal to 1. Furthermore, as discussed in subsection 2.3, throughout the disruption-management, a significant load is shifted to the dispatchers. Therefore, it is possible to assume that if $t_{FD,\vartheta_{T_{LS,i}}}$ falls between the $t_{0,TD}$ and the estimated end of the disruption t_{EDL} , the probability that an additional shunting movement needs to be scheduled may be assumed to be equal to 1.

At this juncture, it becomes necessary to ascertain the adequate means to explain the variation in the probability that an additional shunting movement needs to be scheduled within the above-discussed temporal boundaries. However, before a particular function type can be selected to represent the variation in the probability, it is necessary to locate the origin of such variation. Overall, it can be considered that the x-axis is utilized to describe temporal parameters and the y-axis to describe the probability of occurrence of an additional shunting movement. The origin of the function may be located either at the origin or displaced along the positive quadrant of one or both axes. Thus, the following four alternatives are considered:

- At the origin: it implies that the probability of occurrence of an additional shunting movement is present the moment the vehicle starts with its duties despite the lack of an adjustment to its circulation plan.
- Displaced along the y-axis (i.e. probability): it implies that despite the vehicle has not started its duties, there is a probability that additional shunting movement needs to be scheduled when it finalizes its duties.
- Displaced along the x-axis (i.e. time): it implies that the probability of occurrence of an additional shunting movement tends to zero until an extraordinary event becomes manifest (e.g. a disruption).

Depending on the operational circumstances that want to be explained, different explanations can be advanced to justify every single one of the possibilities described above. Nevertheless, the chosen alternative must be aligned with the context in which the weighting function is being established. Consequently, since dispatchers are particularly prepared to address any disturbance that may occur during the operations before the disruption has occurred, it may be assumed that the probability of occurrence of an additional shunting movement would tend to be non-existent until an extraordinary event becomes manifest. As a result, within the implementing field of the dynamic DRP deployment system, the probability that an additional shunting movement would need to be scheduled starts to rise once the circulation plan has been adjusted (i.e. at $t_{0,TD}$). Therefore, the origin of the function may be considered as being displaced along the x-axis.

Moreover, to explain the rise in the probability that an additional shunting movement would need to be scheduled, different function types may be utilized. As with the establishment of the origin, different function types can be considered (e.g. linear, exponential, cumulative frequency curve, etc...). However, finding a solely theoretical derivation of the function that allows an accurate representation of the attribute under consideration runs the risk of being highly faulted. Therefore, not only for the establishment of the function but also the assumptions utilized to guide its development, a thorough validation based on actual operational data, as the one conducted in subsection 4.4, is necessary.

While the structuring of the dynamic DRP deployment system is focused within the establishment of its logical structure (see subsection 3.3.2), the calibration of the function within actual operative instances is not possible at this juncture. On the other hand, to support the immediate implementation of the dynamic DRP deployment system, a standard approach to compensate for the lack of actual operational information is established. Therefore, an interval function is utilized to allow establishing the weighting function as part of the evaluation structure of the determining variable derived in this subsection.

As a result, utilizing the above-described considerations as an outline, a constant interval function is established. The function abides with the time limits as well as the discussed constraints and focuses on penalizing vehicles that generate an end-of-day imbalance and at the same time, are projected to finalize their duties within the disrupted operations. Generalized in equation 12.40, the weigh $\varphi(t_{FD,\vartheta_{T_{LS},i}})$ can be expressed as a function of the time in which vehicle $\vartheta_{T_{LS},i}$ finalizes its duties.

$$\varphi(t_{FD,\vartheta_{T_{LS},i}}) = 1 + \begin{cases} 0; & \text{if } t_{FD,\vartheta_{T_{LS},i}} > t_{0,TD} + t_{EDL} \\ 1; & t_{0,TD} \leq t_{FD,\vartheta_{T_{LS},i}} \leq t_{0,TD} + t_{EDL} \end{cases} \quad (12.40)$$

In equation 12.40, two intervals are recognized. Initially, no additional penalty affects the journey time of an additional shunting movement, if the time in which the vehicle finalizes its duties $t_{FD,\vartheta_{T_{LS},i}}$ is larger than the estimated end of the disruption (i.e. $t_{0,TD} + t_{EDL}$). Lastly, the function penalizes the journey time with an additional value if the time in which the vehicle finalizes its duties $t_{FD,\vartheta_{T_{LS},i}}$ occurs between the system's deployment time $t_{0,TD}$ and the estimated end of the disruption (i.e. $t_{0,TD} + t_{EDL}$).

Summary

In this subsection, a determining variable to assess the end-of-day imbalances has been carefully derived and discussed. The determining variable supports the evaluation of the PVSCS combination, concentrating on the effects of the adjustment of the circulation plan. These effects have been explained as the induced end-of-day imbalances. If not addressed, the influence of the disruption would be echoed to the network's operations on the next day.

Considering that the handling of this matter falls outside the scope of the dynamic DRP deployment system, the evaluation focuses on a projection of the direct of operating situations that may be generated. To this end, the determining variable proposed in this subsection assesses the induced end-of-day imbalance of every single vehicle based on the projected journey time necessary to reach their scheduled parking locations after the finalization of their duties.

The determining variable also foresees the need to weigh the journey time, since it is recognized that a dispatcher would still have the chance to address the situation after the disruption has ended. However, due to the lack of operation information, an interval function has been put forward. The interval weighting function penalizes vehicles projected to generate an end-of-day imbalance and that finalize their duties during the disruption.

12.3.7. Summary

The evaluation structures of each of the determining variables detailed and derived within this subsection constitute the core of the assessment module. The resulting evaluation structure of each

determining variable derives from taking into consideration the requirements and objectives of the system as well as the framework provided by existing approaches.

Overall, the framework provided by the existing approaches discussed in subsection 12.2.1, have been utterly beneficial in some cases and had a very limited relevance on some other cases. For example, the existing structures supporting the evaluation of the expected relative-time changes (i.e. Oetting et al. 2013 and DB Netz 2017) have proven to be limited within the context of disrupted operations. As a result, a different approach, and most importantly, different weighting mechanisms needed to be put forward (see subsection 12.3.1). On the other hand, the existing evaluation approach providing support for the assessment of the expected change in the projected operating situation has been instrumental for the evaluation of the determining variable. Furthermore, the existing approach supporting the evaluation of the changes in platform tracks (i.e. DB Netz 2017) has been left aside, and a different attribute (i.e. minimum platform exchange time for passengers) has been utilized to generalize the assessment.

The evaluation structure of the last two determining variables, namely, the assessment of changes in the turning stations and the induced end-of-day imbalances, have been completely derived from the bottom-up. These two determining variables have been specially tailored to form part of the modular structure of the system's evaluation functions. Their evaluation structure has been derived after exploring different alternatives and a consideration of potential operational attributes.

On another note, the weight w_i for every determining variable DV_i still needs to be established (see equations 12.1 and 12.2). However, since the development of the dynamic DRP deployment system is aligned with the establishment of its logical structure and not with its testing in actual operating environments (see subsection 3.3.2), at this juncture, it is not practically feasible to derive the actual weight w_i of every determining variable. However, a standard approach and general lineaments may be put forward to support their subsequent calibration within actual operating environments.

Depending on the implementing field, one alternative may be considering specific determining variables to have further relevance in the assessment than others. Establishing the weight of each determining variable under this consideration would discriminate certain attributes over others, which would remove the objectivity from the assessment and compromise the effectiveness of the system's overall approach. Therefore, utilizing this approach to establish the weight of the determining variables is not recommended. On the other hand, the resulting magnitude of the assessed attributes and the determining variables within different operating environments may be also be utilized as an approach to establish their weigh.

It must be considered that the temporal magnitude acquired from every single module can vary significantly. An example of this is the transferred passengers' waiting time across a certain number of stations versus the expected relative-time that can be generated within one single conflict resolution alternative. Establishing the weight of each determining variable under this approach would allow a much more objective and precise appreciation of each attribute within the function, an aspect which is aligned with this module's general objectives (see subsection 3.2.2 and subsection 12.2). Therefore, this last approach is recommended as the system's standard approach to steer the calibration and determine the weight of every determining variable within actual operating environments.

Furthermore, within the framework introduced by the proposed approach to determine the weight of every determining variable within actual operating environments, it might be possible to

establish some benchmark weights for the determining variables. Initially, the foundation of the evaluation function is provided by the first two determining variables, which are to be left unaffected (i.e. $w_i = 1$), particularly, considering that DV_2 has already been weighted within its own module. Therefore, the rest of the determining variables may be calibrated according to the relative magnitude of their assessed attributes within a disrupted situation vis-à-vis the first two determining variables as the prime indicator of the delay induced in the system.

Finally, having discussed the evaluation structure of every determining variable in thorough detail, the fitness of every conflict resolution alternative and the PVSCS combination can be ascertained as detailed by the structured approach described in subsection 12.2.2.

12.4. Assessment of PVSCS Combinations

As detailed in the structured approach to conduct the assessment of the PVSCS combinations in subsection 12.2.2, once the conflict resolution alternatives have been evaluated and selected, these are saved for the PVSCS combination. At this juncture, the PVSCS combination under investigation would be completely fixed (i.e. conflict-free). Later, the assessment is complemented by assessing the two complementary determining variables that become relevant once the PVSCS combination has been completely fixed (i.e. DV_5 and DV_6 – see subsection 12.2.2). This subsection provides further detail into the process required to conclude the assessment of the PVSCS combinations and derive its general fitness $R(I_{S,o})$.

At the outset, as depicted in figure 12.2, the fitness $R(RS_{C_f})$ of every conflict resolution alternative utilized to fix the PVSCS combination requires additional handling to remove non-relevant attributes. The removal of the non-relevant attributes from the fitness of every conflict resolution alternative used to fix the PVSCS combination allows deriving a much more representative understanding of their actual effects on the operating situation of the network after they have been chosen. Thereafter, the evaluation of the PVSCS combination is complemented by an assessment of the last two determining variables. As discussed in subsection 12.2.2, DV_5 and DV_6 focus on changes of the turning station for the PVSCS combinations and the resulting end of the day imbalance as the product of the adjustment of their circulation plans.

As detailed in figure 12.2, the refined fitness of every conflict resolution alternative allows ascertaining the so-called partial fitness of the PVSCS combination (this time as a conflict-free schedule). The approach guiding the establishment of the partial fitness of the PVSCS combination has been detailed in subsection 12.2.2; however, the removal of the non-relevant attributes still needs to be further clarified. Therefore, subsection 12.4.1 provides a much more detailed discussion regarding the process utilized to ascertain the partial fitness $R(RS_{C_f})'$ of the PVSCS combination under investigation. This process is complemented in subsection 12.4.2. by a brief discussion on the final process utilized to ascertain the actual fitness of the PVSCS combination.

12.4.1. Partial Fitness of the PVSCS Combination Following the CDCR Process.

The partial evaluation of the PVSCS combination is conducted by accumulating the already assessed effects of every conflict resolution alternative utilized to fix the PVSCS combination. However, before the fitness of every conflict resolution alternative can be accumulated, non-relevant attributes must be removed. This subsection provides a closer look at the processes for

the identification of the non-relevant attributes supporting a much more precise establishment of the partial fitness of the PVSCS combination.

Having established the evaluation structure of every determining variable throughout subsection 12.3 attributes that are non-relevant to reflect the effects on the operating situation of a conflict resolution alternative that has been already selected to fix the PVSCS combination may be recognized.

Since any potentially induced circulation conflict would be identified as a follow-up conflict and handled in later steps of the resolution process, once the conflict resolution alternative has been selected, the effects of the relative-time change on the train services linked by the circulation plan of all directly involved trains $\Delta RT_{Circualtion}$ in DV_1 are not relevant once the conflict resolution alternative has been selected. In the same way, since the assessment of the induced changes in the projected operating situation ascertained by DV_2 provides a look-ahead of the implementation of a conflict resolution alternative, they may be considered meaningless to reflect in the actual fitness of the PVSCS combination. Therefore, having identified the non-relevant attributes to be removed from the already ascertained effects of every conflict resolution alternative utilized to fix the PVSCS combination, the process detailed in figure 12.2 can be further specified.

Initially, as detailed in the structured approach in subsection 12.2, the assessed effects $R(RS_{C_f})$ of every conflict resolution alternative utilized to fix the PVSCS combination are saved in a set $Sol_{I_{S,o}}$. The assessed effects of the utilized conflict resolutions are modified to remove the already identified non-relevant attributes, namely, $\Delta RT_{Circualtion}$ in DV_1 and the whole DV_2 . Once these attributes have been removed, the partial fitness $R(I_{S,o})'$ of the PVSCS combination $I_{S,o}$ can be established.

As a result, the overall process to derive the partial fitness of the PVSCS combination is conducted following the four steps detailed below.

1. Starting with ($C_f = 0$) incorporate the assessed effects of the conflict resolution $R(RS_{C_f})$ respective to $C_f + 1$ from the set $Sol_{I_{S,o}}$.
 - If there are no more conflict resolutions in $Sol_{I_{S,o}}$ step 4 can be conducted.
2. From the incorporated $R(RS_{C_f})$, the weighted values respective to the determining variable DV_2 and the effects of the relative-time change on the train services liked by the circulation plan of all directly involved trains $\Delta RT_{Circualtion}$ are removed. The resulting effect can be ascertained as generalized by equation 12.41.

$$R(RS_{C_f}) = R(RS_{C_f}) - (w_1 * \Delta RT_{Circualtion} + w_2 * DV_2) \quad (12.41)$$

3. Return to step 1.
4. Determine the partial fitness of the PVSCS combination $R(I_{S,o})'$ by simply adding the resulting effects of all conflict resolution alternatives $R(RS_{C_f})$. The partial fitness of the PVSCS combination can be ascertained as in equation 12.42.

$$R(I_{S,o})' = \sum_1^{C_f} R(RS_{C_f}) \quad (12.42)$$

12.4.2. Ascertaining the Fitness of the PVSCS Combination

The assessment of the PVSCS combination concludes by incorporating the weighted fitness of the two complementary determining variables (see subsection 12.2) ascertained once the combination had been completely fixed and transformed into a conflict-free schedule.

As discussed in subsection 12.2.2 and depicted in figure 12.2, this last process utilizes the partial fitness of the PVSCS combination $R(I_{S,o})'$ as a baseline (see subsection 12.4.1) and incorporates the weighted fitness of the two complementary determining variables, namely, induced change in turning stations and end-of-day imbalances (i.e. respectively DV_5 and DV_6).

Equation 12.43, modifies equation 12.2 to include the establishment of the partial fitness of the PVSCS combination, as discussed in 12.4.1.

$$R(I_{S,o}) = R(I_{S,o})' + \sum_{i=5}^{i=6} w_i * DV_i \quad (12.43)$$

This concludes the assessment process, as foreseen by the structured approach and the abiding by the system's requirements. The resulting fitness can be returned to the corresponding algorithm in the PVSCS combination module (see section 10).

12.5. Closing Remarks

In this section, a structured approach to assess both the conflict resolution alternatives developed in the CDCR process and the PVSCS combination assembly has been successfully established. Throughout the whole section, the respective processes have been derived and detailed for each of the tasks at hand. First, the assessment structure, which includes a modular evaluation function constituted by isolated determining variables, has been derived to support the capability of the CDCR process to conduct an automatic fixing process of the PVSCS combinations (see section 11). Second, a framework to assess the fitness of already conflict-free PVSCS combinations and in this way, support the overall PVSCS combination assembly process, as discussed in section 10, has been effectively established (see figure 3.1).

The assessment module, as foreseen by the system's overall approach, constitutes the final step in the two-step repairing heuristic, bridging the line-specific guidelines detailed by the chosen DRP operating concept with the actual disrupted operations at the vehicle-specific level (see subsection 3.5.2). Through the structured approach introduced in subsection 12.2, the assessment module is adeptly capable of assessing both of the operational levels handled in the dynamic DRP deployment system. Arguably, the cornerstone of the structured approach proposed in this section is constituted by its specially tailored evaluation functions, which allow the systematic handling of the system's conflict resolution alternatives developed to address the disruption at each of the operational levels. At a line-specific level, the assessment is focused on PVSCS combinations, which are assembled by selecting PVSCS from the trains' PVSCS sets (see section 9). At the vehicle-specific level, the assessment is focused on conflict resolution alternatives developed in the CDCR process to address conflicts between trains and with further operational constraints.

Furthermore, the assessment structure advanced at each of these levels is in itself a submodular structure, providing flexibility to the conduct the assessment so that it might be adeptly retrofitted or adjusted to address different implementing fields. The assessment structure and the processes at each of these levels support the system's general validity.

Initially, an evaluation function has been advanced to assess the conflict resolution alternatives developed in the CDCR process to address vehicle-specific conflicts regardless of the conflict type. The proposed approach aligned with the CDCR process also supports the management and handling of the process for selecting the most adept conflict resolution alternative among available options.

Subsequently, a different but corresponding approach has also been advanced to assess the PVSCS combinations and return the fitness values to the respective metaheuristic in the assembly process. As discussed in section 10, the fitness of the PVSCS combination allows the respective metaheuristic algorithms to further their exploration of the search space. In this regard, two of the central requirements of the system are being supported. First, the capability to identify the set of line-specific measures that better fit with the nature of the disruption and the actual operating situation of every train in the system in correspondence to their line’s DRP operating concept. Second, upholding the capability of the system to transition to stable operations.

Moreover, at the center of the approach, the modular structure of the evaluation functions allows to include or exclude certain parameters as decided by the system’s implementing field. Furthermore, based on existing approaches and close consideration of all the predefined elemental conflict solution alternatives, which have been utilized to fulfill the CDCR process projected on the two operational levels, relevant determining variables have been established. The ten determining variables identified in subsection 6.3 have been contrasted against existing approaches that support their clustering in a total of six determining variables to derive the evaluation functions utilized in the structured approach.

The handling of these determining variables, namely, the attributes being assessed and the existing assessment approaches, have been detailed in table 12.3. The table provides an overview of the overall handling of each of the determining variables, after having established the evaluation structure of each of the determining variables that constitute the evaluation functions. Table 12.3 recognizes, for each of the determining variables which have been derived in table 12.1, the approach supporting their evaluation, the attribute being assessed, and its respective decision units.

Table 12.3 Summary of the handling of the ten determining variables identified from the examination of the predefined elemental conflict solution alternatives across both line-specific and vehicle-specific operational levels within the assessment module (by author)

Type	Determining Variables	Evaluation Approach	Attributes	Decision Units
Temporal	Train delay	Establish the expected relative-time changes due to the implementation of a conflict resolution alternative	Waiting time	Relative-time changes
Spatial	Changes in routes		Change in the operational time	
Spatial	Changes in platform tracks	Impact on users based on local conditions	Necessary time for passengers’ platform exchange	Minimum platform exchange time

Type	Determining Variables	Evaluation Approach	Attributes	Decision Units
Spatial	Changes in scheduled turning stations	Impact of the occupancy time of the turning train on the operating situation at the host station	Capacity Consumption	Occupancy times and their effect on the quality of service
Malus	Train Service Cancellations	Existence and handling of service conflicts	Passengers' waiting time at the stop	Transferred passengers' waiting times
Malus	End-of-day imbalances	Potential need for an additional shunting movement	Journey time to the scheduled parking location	Journey times
Malus	Number of cancelled stops	Existence and handling of service conflicts	Passengers' waiting time at the stop	Transferred passengers' waiting time
Look-Ahead	Follow-up occupancy conflicts	Establish the changes in the projected operating situation	Severity and number of follow-up conflicts	Difference in the in the severity and number of the projected follow-up conflicts
Look-Ahead	Follow-up circulation conflicts			
Look-Ahead	Follow-up service conflicts			

Each of the six resulting determining variables has been adeptly detailed thorough subsection 12.3 and their interrelation generalized in the evaluation functions generalized in equations 12.1 and 12.2. While the respective weights of the determining variables have not been expressly established in this section, a foundation to support the immediate implementation and their calibration have been recommended.

All in all, given that at this stage every PVSCS combination that has been assembled in section 10 can be fixed entirely and made into a conflict-free schedule, it may be concluded in general terms that the specific objective of the system has been achieved. However, by returning the fitness of the PVSCS combination to the respective metaheuristic algorithm and as discussed in section 10.3 and 10.6, a set of candidate conflict-free schedules δ_v would be ascertained. The selection of the conflict-free schedule from the set δ_v and the final adjustment outlined to uphold the quality of the solutions, as discussed in subsection 3.5.2 and depicted in figure 3.1, are discussed in the following section.

13. Adjustment and Selection of the Conflict-Free Schedule

13.1. Introduction

The module for the adjustment and selection of the conflict-free PVSCS combinations (i.e. conflict-free schedules), supports the capability of the dynamic DRP deployment system to enhance the quality of the candidate conflict-free schedules obtained from the metaheuristic algorithms in section 10 and ultimately, the ability to select the system's proposed solution. More specifically, once the metaheuristic in charge of assembling and managing the PVSCS combinations has fulfilled its termination criteria (see section 10) with support of the CDCR process (see section 11) and assessment module (see section 12), a set of candidate conflict-free schedules are obtained. This module has the sole objective of adjusting and refining the conflict-free schedules to support a much more accurate selection of the best possible solution. The solution constitutes a train number and minutes specific adjustment of the original schedule guided by the line-specific DRP operating concepts to the actual disruption.

As discussed in subsection 3.5.2, the adjustment and selection module is necessary due to two general reasons. On the one hand, the PVSCS combinations have been fixed (i.e. made conflict-free) by an automatic vehicle-specific CDCR process. Given that conflict resolutions are introduced in the PVSCS combination one by one, the systematic approach of the CDCR process may cause certain conflict resolutions introduced in the PVSCS combination at a given moment during the fixing process to become irrelevant and end-up being unnecessary once the resulting PVSCS combination is conflict-free. More specifically, since the CDCR process has been designed to conduct a synchronous resolution of different types of conflicts by combining different elemental conflict solutions, a solution that was necessary at a given moment of implementation of the CDCR process may result to be completely unnecessary when introducing a later solution to resolve a different type of conflict. Therefore, an adjustment process would allow refining the quality of the resulting conflict-free PVSCS combinations by removing the unnecessary conflict resolutions. On the other hand, the Genetic algorithm delivers a set of candidate conflict-free PVSCS combinations (i.e. conflict-free schedules) as a set of potential solutions. If these schedules are adjusted, a much more informed overview of the best possible alternative may be acquired. Consequently, the already established fitness of every conflict-free PVSCS combinations in the set of candidate solutions would also need to be modified due to the removal or modification of the conflict resolutions.

The module receives as input, the set of conflict-free PVSCS combinations from the converging generation of the genetic algorithm δ_v (see subsection 10.6 – figure 10.10). The set δ_v contains conflict-free PVSCS combinations that must be adjusted in order to derive the system's solution. Additionally, the fitness of the conflict-free combinations should be modified so as to allow the system to select the ultimate best conflict-free PVSCS combination as its proposed solution for the deployment of the DRP to the actual operating situation of the network (see subsection 3.2.2).

Throughout this section, a structured approach that allows supporting the adjustment of the conflict-free PVSCS combinations (i.e. schedules) as a result of the exploration of multiple PVSCS combinations advanced in section 10 is discussed and derived in detail. To do so, the module incorporates general principles discussed by existing methods and seeks to derive a heuristic approach to carry out the adjustment of the conflict-free PVSCS combinations. Additionally, the ability of the adjustment to modify the fitness of the PVSCS combination should also be supported by the heuristic approach being derived throughout this section.

Overall, this section is divided into two general subsections. Firstly, the module's structured approach based on the existing models is introduced in subsection 13.2. Later, subsection 13.3 provides a focused discussion on the necessary processes for the adjustment of the conflict-free schedules as the keystone process within the module's structured approach.

13.2. Structured Approach

As briefly mentioned in subsection 13.1, this module has the explicit objective to adjust the set of candidate conflict-free PVSCS combinations (i.e. conflict-free schedules) provided by the Genetic algorithm (see subsection 10.6) and select one alternative to guarantee the quality of the dynamic DRP deployment system's proposed solution. As detailed in the systems overall approach (see subsection 3.5.2), the adjustment of the schedules is based on the approach first introduced by Chiang et al. (1998), which has been discussed in subsection 2.2.3. This subsection derives and discusses the structured approach to support the adjustment and selection processes of the conflict-free schedule.

The module discussed within this section receives as input information the set of candidate conflict-free schedules δ_v equivalent to the population with which the Genetic algorithm has satisfied its termination criteria (see subsection 10.6 – also see figure 3.1). The set δ_v contains a number of F candidate conflict-free PVSCS combinations (i.e. conflict-free schedules); thus, the adjustment and selection process entails selecting a subset of schedules from δ_v so that they are adjusted, and ultimately, one can be selected as the system's proposed solution for the deployment of the chosen DRP operating concept to the actual disruption.

As discussed in subsection 3.5.2, utilizing a synchronous and automatic CDCR process for the fixing of the assembled PVSCS combinations may render certain conflict resolution alternatives which have been implemented in early steps of the CDCR process, as being unnecessary once the schedule. Therefore, the schedule adjustment must allow the identification and removal of unnecessary conflict resolution measures to uphold the quality of the dynamic DRP deployment system's proposed solution.

The understanding regarding unnecessary measures has already been introduced in subsection 2.2.3 and further expanded within subsections 3.6.2 as well as 3.7.2. As discussed in the establishment of the dynamic DRP deployment system overall approach (see subsection 3.5.2), the adjustment processes to be advanced within this module is founded over the considerations made in Chiang et al. (1998). As discussed in subsection 2.2.3, the model proposed by the authors identifies and removes unnecessary waiting times, which have been utilized to solve occupancy conflicts and that are no longer necessary due to subsequent changes in the projected operating situation. The most critical obstacle which has been identified by the authors when completing this task in parallel with the CDCR process is the cycling problem. This occurs when an unnecessary measure is removed, generating one or more follow-up conflicts that must be solved asynchronously. The asynchronous identification and resolution of unnecessary measures conducted in parallel to the CDCR process may induce an endless computational loop. For a much more detailed example of an endless computational loop, refer to Chiang et al. (1998, pp. 304-305).

Different considerations can be advanced to structure an approach that supports carrying out the adjustment and selection of the conflict-free schedules in the set δ_v . As built-in in previous modules, in order to abide with the system's requirements and limitations (see subsection 3.4.2),

namely, ensuring that the conflict-free schedules are attained in the shortest time possible without disproportionately compromising their feasibility, this module's structured approach may be advanced to be adjustable to the available computational effort. Thus, the approach must be structured so as to minimize the added complexity to the overall system, while it also supports its capability to perform the adjustment of the conflict-free schedules with different levels of detail.

Additionally, since the removal of the unnecessary measures would inherently affect the fitness of the conflict-free PVSCS combinations, the means to ascertain the adjusted fitness after all unnecessary measures have been removed must be supported by the structured approach. Ascertaining the adjusted fitness would allow the module to select the best PVSCS combination after the adjustment process and display it as the system's proposed solution.

Aligned with the consideration made above, the approach is initially structured so as to support a variable selection of the conflict-free schedules from the set δ_v . Depending on the computational effort available, a number of F' elite schedules may be selected for their adjustment and subsequent consideration as the system's proposed solution. In this way, there is the possibility to select simply the conflict-free schedule with the best fitness or a F' number of elite schedules from the set δ_v . By introducing a subset of elite schedules, the number of schedules to be adjusted may be modified, which makes the approach much more flexible to the system's implementing field.

As the recommended standard process for the dynamic DRP deployment system, due to the Genetic algorithm's parallel handling of alternatives, it is considered that all the conflict-free schedules in the set δ_v stand as potential solutions. Therefore, it is recommended that all conflict-free schedules in the set are adjusted to make sure that the system delivers the best possible solution within its limitations (see subsection 3.5.2). However, since F is contingent on the number of trains in the combinations, the more complex the problem, the higher the number of conflict-free schedules that need to be adjusted (see subsection 10.6.1). Therefore, equation 13.0 provides a general relation to establishing a variable number of elite schedules F' . Equation 13.0 utilizes a parameter Es , which may acquire values between one and zero, affecting the number of elements F in the set δ_v and derive the desired number of elite schedules F' to be adjusted by the module.

$$F' = [F * Es] \quad (13.0)$$

The recommended value for parameter Es as part of the recommended standard approach of the dynamic DRP deployment system is one (i.e. $Es = 1$). However, the parameter Es can also be calibrated after its implementation within an actual operating environment to secure the system's efficiency and effectiveness.

As a result, the structured approach guiding the selection and adjustment of the conflict-free schedules is conducted, as depicted in figure 13.1.

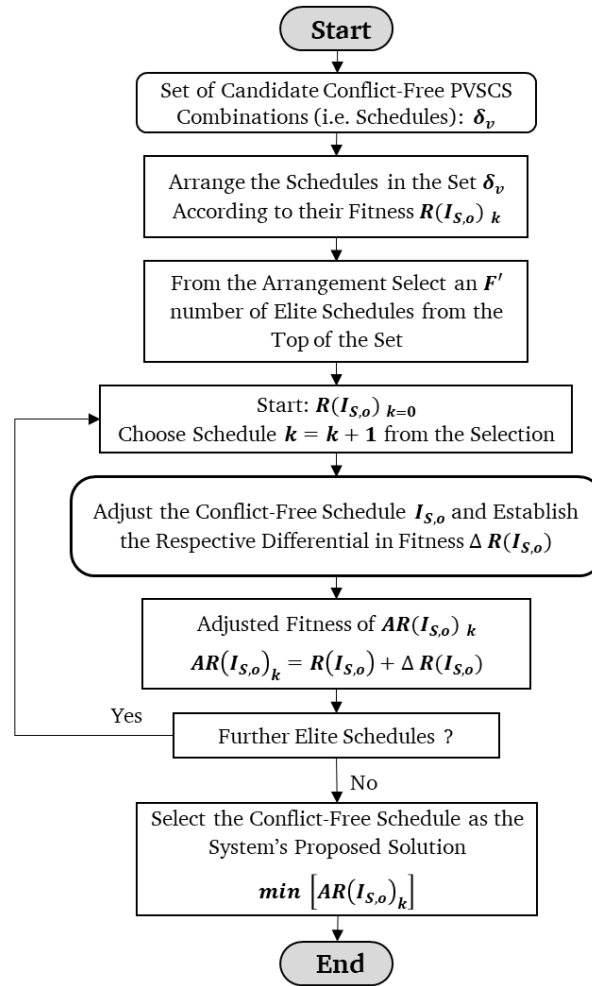

Figure 13.1 General approach for adjusting the conflict-free schedules $I_{S,o}$ and selecting the one to constitute the proposed solution of the dynamic DRP deployment system (by author)

The structured approach foreseen to support the adjustment and selection process of the conflict-free schedules is constituted in eight overall steps.

1. The process starts by acknowledging and incorporating all necessary information from the converged Genetic algorithm. This implies the set δ_v containing the converging population with a F number of PVSCS combinations $I_{S,o}$, which are by this juncture already conflict-free (i.e. schedules) and had their respective fitness $R(I_{S,o})$ already ascertained.
2. The conflict-free PVSCS combinations (i.e. schedules) in the set δ_v are arranged according to their fitness, starting with the one with the lowest fitness value $R(I_{S,o})_k$, which is recognized as $k = 1$.
3. From the arranged conflict-free schedules, a number of elite schedules equal to F' is selected so that they can be adjusted. The number of elite schedules F' is ascertained as detailed in equation 13.0, depending on the computational effort available.
4. Starting with alternative ($k = 0$), the next conflict-free schedule in $R(I_{S,o})_{k+1}$ is selected.
5. The conflict-free schedule is adjusted utilizing the approach depicted in figure 13.2, and the respective differential in its fitness $\Delta R(I_{S,o})$ is ascertained (see subsection 13.3).
6. The adjusted fitness of the conflict-free schedule is $AR(I_{S,o})_k$ is ascertained.
7. If there are further elite conflict-free schedules $R(I_{S,o})_k$ that have not been handled, the process returns to step 4, otherwise step 8 is conducted.

-
8. The conflict resolution alternative with the best-adjusted fitness $\min AR(I_{s,o})_k$ is selected and displayed as the dynamic DRP deployment system's solution.

The structured approach detailed in figure 13.1 has been derived to support the adjustment and selection, as foreseen by the dynamic DRP deployment system's general approach. The proposed approach allows selecting a flexible number of F' conflict-free PVSCS combinations (i.e. conflict-free schedules) so that they can be adjusted. As detailed in the approach, adjusting the schedules also entails adjusting their fitness so as to allow ascertaining with much more precision the best possible alternative.

While the handling and selection of the conflict-free schedules have been covered with enough detail within the structured approach, the process supporting the adjustment of the conflict-free PVSCS combinations (i.e. schedules) still needs to be further derived and detailed. Subsection 13.3 provides a detailed discussion regarding the adjustment of every conflict-free schedule and its respective fitness.

13.3. Adjustment of the Conflict-Free Schedules

As it has been discussed in subsection 3.5.2, the adjustment of the conflict-free schedules consists of an identification and removal of unnecessary measures within every conflict resolution utilized to fix the PVSCS combinations. This subsection derives an approach aligned with the module's structured approach to support the adjustment of the F' chosen conflict-free schedules.

As it has been discussed in subsection 13.2 and 3.5.2, the adjustment process is founded over the lineaments first identified in the work of Chiang et al. (1998). As discussed in subsection 2.2.3, in their model, the authors focus solely on the handling of unnecessary shifts in time introduced to address occupancy conflicts.

This subsection first derives the structure for an approach that supports the adjustment of the schedule as part of the dynamic DRP deployment system (subsection 13.3.1). Later, the most relevant processes within the proposed approach are described in further detail (subsection 13.3.2 and 13.3.3).

13.3.1. Structured Approach for the Schedule Adjustment

As it has been discussed in subsection 3.5.2, the adjustment of the resulting conflict-free schedules would allow upholding the quality of the results proposed by removing any unnecessary measure that has been introduced in the automatic CDCR process. This subsection derives a structured approach that allows conducting the schedule adjustment within the framework of the module's structured approach (see figure 13.1) and the system requirements and limitations (see subsections 3.3.2 and 3.4.2).

Overall, there is no one unique approach that can be derived to remove unnecessary measures and adjust the schedule. However, by considering the principles introduced in Chiang et al. (1998) and the general structure of the modules advanced throughout previous sections of this work, two alternatives have been considered to derive the structured approach to conduct the adjustment of the conflict-free PVSCS combinations (i.e. removal of unnecessary measures).

The first alternative entails conducting the removal of unnecessary measures asynchronously as it has been done for the shifts in time in the model introduced by Chiang et al. (1998) (see subsection

2.2.3). The approach introduced in Chiang et al. is conducted in parallel with the CDCR process and regarded as being “*non-chronological backtracking*” (1998, p. 304). This approach allows the adjustment process to go back to the conflict-free region during the implementation of the CDCR process to remove unnecessary measures and resolve their follow-up conflicts.

The second alternative utilizes CDCR principles to derive a structured approach to remove unnecessary measures. An approach based on CDCR principles would entail supporting its basic processes (see subsection 2.2.3), namely, identification of unnecessary measures, their sorting in a list and the utilization of predefined solution alternatives for their systematic removal from the schedule. However, this latter approach also requires an assessment structure to decide whether it removes or maintains an identified unnecessary measure from the conflict-free schedule at a particular step in its process. It may be possible that an unnecessary measure is maintained if the benefit which has been gained by its removal is offset by the measures that are necessary to solve the follow-up conflicts that have been generated.

As discussed in subsection 3.5.2, the adjustment of the PVSCS combinations is foreseen to be conducted once the whole PVSCS combination is conflict-free. This has been foreseen as it would allow avoiding adding complexity to the vehicle-specific CDCR process, which handles four different conflict types (see subsection 11.3.2) and the system as a whole (i.e. facilitate the fixing of PVSCS combinations assembled by the Genetic algorithm). Therefore, the first alternative is not aligned with the system's structure. However, it highlights the need to consider and support the influence of the removal of an unnecessary measure on third trains (i.e. trains not directly affected by the measures) and to address any induced follow-up conflicts.

Seeking to derive a comprehensive adjustment process of the conflict-free schedules, the structured approach guiding the removal of unnecessary measures derived in this subsection foresees the utilization of the second alternative. Therefore, the removal of the unnecessary measures in the conflict-free schedules is derived utilizing general CDCR principles. Additionally, the identification and removal of the unnecessary measures must be conducted under consideration of third trains, maintaining the train order to restrict generating suboptimal solutions, and solving any induced follow-up conflicts.

In order to abide with the selected alternative, the structured approach to conduct the schedule adjustment acquires a similar arrangement as the one discussed for the automatic CDCR process. The approach should conduct the identification of unnecessary measures (i.e. considering third trains) throughout the entire conflict-free schedule, the synchronous sorting of the identified unnecessary measures in one single list (to avoid generating an endless computational loop), the development of alternatives to remove them from the schedule and the assessment of their projected removal. Furthermore, the approach must support the handling of follow-up conflicts as the by-product of the adjustment.

As part of the dynamic DRP deployment system, the removal of unnecessary measures in the conflict-free schedules can make use of the already existing CDCR process and assessment modules. Therefore, the structured approach may utilize these processes to support both the removal of unnecessary measures and comprehensive management of the induced follow-up conflicts.

As a result, the proposed structured approach for schedule adjustment advanced on CDCR principles is depicted in figure 13.2. The adjustment process depicted in figure 13.2 accounts for step number 5 in the module's structured approach illustrated in figure 13.1.

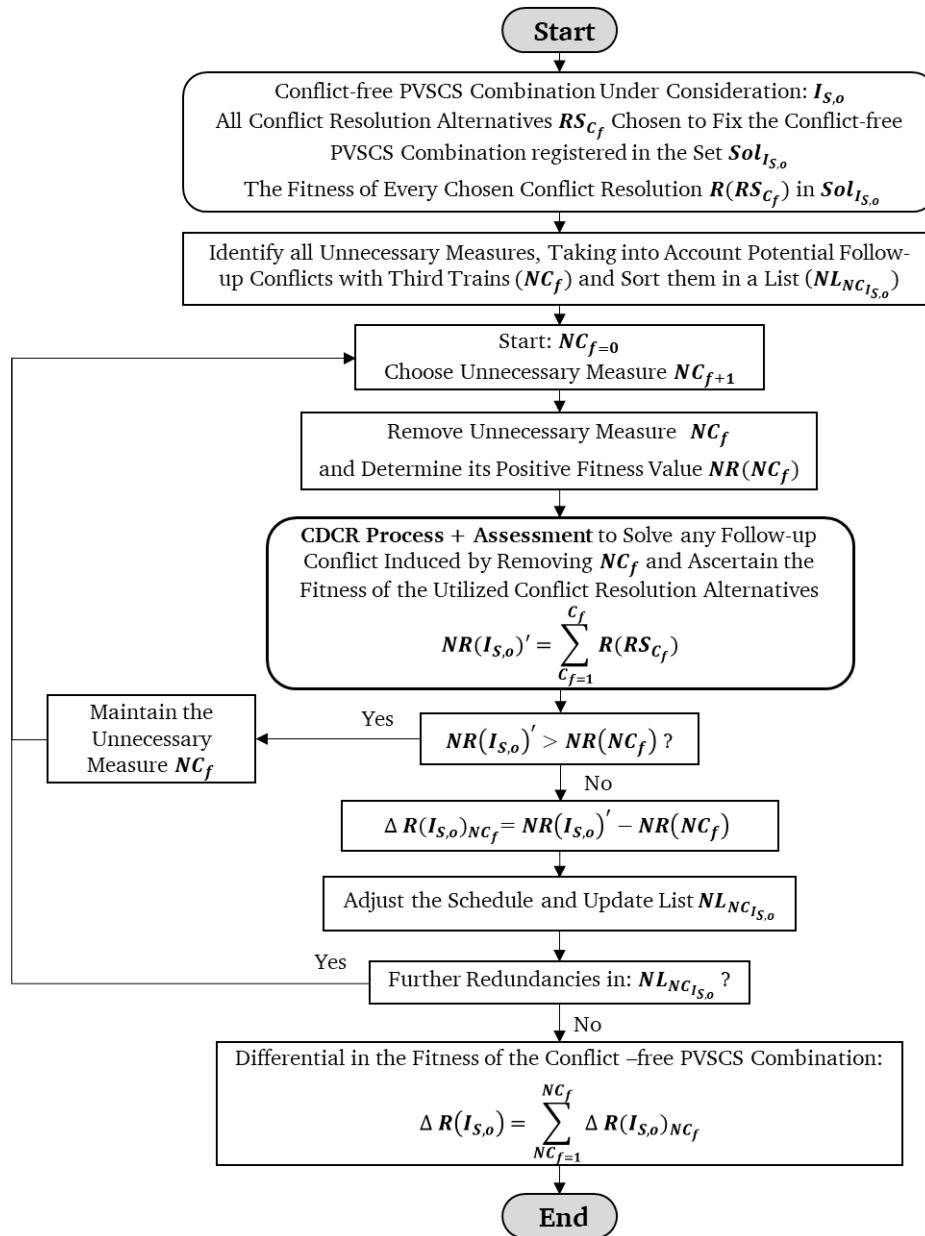

Figure 13.2 Proposed approach for Adjusting the Conflict-free schedule through the removal of unnecessary measures (by author)

The structured approach introduced to support the adjustment of the conflict-free schedules is constituted in eight steps.

1. For the conflict-free PVSCS combination $I_{S,o}$ under investigation, the unnecessary measures utilized in the conflict resolution alternatives RS_{C_f} stored in the set $Sol_{I_{S,o}}$ are acknowledged.
2. Unnecessary measures NC_f within each of the conflict resolutions RS_{C_f} are identified, taking into account potential follow-up conflicts with third trains and introduced in a list $NL_{NC_{I_{S,o}}}$. The list is sorted synchronously, starting with the unnecessary measure NC_f with the earliest occurrence. The list is sorted synchronously and updated every time an unnecessary measure has been removed in order to ensure that the removal does not get caught in an endless loop, as identified in the asynchronous approach introduced by Chiang et al. (1998).

3. Starting with $NC_{f=0}$, the next unnecessary measure in the list is selected NC_{f+1} .
4. The chosen conflict resolution alternative RS_{C_f} in which the unnecessary measure takes place is acknowledged, which allows the system to recognize its already assessed effect $R(RS_{C_f})$, remove the unnecessary measure NC_f , project its effect on the operating situation and assert the positive fitness $NR(NC_f)$ attained by its removal.
5. The projected effect on the operating situation attained by removing the unnecessary measure permits to identify all induced follow-up conflicts. To address the follow-up conflicts and return the schedule to its conflict-free condition, the CDCR process and assessment module (see sections 11 and 12, respectively) are introduced in the structure. At the same time, these modules would allow ascertaining the partial fitness $NR(I_{S,o})'$ of the conflict resolutions utilized to address all follow-up conflicts. The partial fitness $NR(I_{S,o})'$ is referred to as explained in subsection 12.4.1.
6. The positive fitness $NR(NC_f)$ attained by removing the unnecessary measure is compared with the partial fitness $NR(I_{S,o})'$ of the conflict resolutions utilized to address the induced follow-up conflicts.
 - If the partial fitness is larger than the positive fitness (i.e. $NR(I_{S,o})' > NR(NC_f)$) the unnecessary measure is maintained in the schedule, removed from the list, and the process returns to step 3.
 - If the partial fitness is smaller or equal to the positive fitness (i.e. $NR(I_{S,o})' \leq NR(NC_f)$) the fitness differential $\Delta R(I_{S,o})_{NC_f}$ attained by removing the unnecessary measure NC_f is ascertained (see figure 13.2), the schedule adjusted and the list $NL_{NC_{I_{S,o}}}$ updated to include any modifications in the unnecessary measures. Updating the list entails introducing any modification on unnecessary measures that are already in the list, removing them if it is necessary, and adding any new unnecessary measures that may be identified.
7. If there are further elements in the list $NL_{NC_{I_{S,o}}}$ that have not been handled, the process returns to step 3, otherwise step 8 is conducted.
8. The fitness differential $\Delta R(I_{S,o})$ for the adjusted conflict-free schedule is ascertained and returned to the module's structured approach.

The approach detailed in figure 13.2 has been derived to support the adjustment of the conflict-free schedule by removing, one by one, unnecessary measures in the conflict resolutions utilized to fix the conflict-free PVSCS combination under consideration. With the proposed approach, the adjustment process is conducted synchronously, taking into consideration the existence of third trains and allowing prompt handling of any follow-up conflict that may be induced. As detailed in the module's structured approach, adjusting the conflict-free PVSCS combination also entails adjusting their fitness.

As a complement to this subsection and to provide a detailed description of the schedule adjustment process inspired by CDCR principles, the process is further detailed in the following subsections. Initially, in subsection 13.3.2, the identification of unnecessary measures, their removal and the establishment of the positive fitness after their removal is discussed in detail. Later subsection 13.3.3, briefly discusses the utilization of the existing CDCR process and assessment modules (see respective sections 11 and 12), for the management of the induced follow-up conflicts.

13.3.2. Identification and Removal of Unnecessary Measures in the Conflict-Free Schedules

As discussed in the proposed approach to conduct the adjustment of the schedules, unnecessary measures are identified for every elemental conflict solution alternative implemented in the conflict resolutions utilized to fix the PVSCS combination $I_{s,o}$ under consideration. Every single one of the vehicle-specific elemental conflict solution alternatives detailed in subsection 6.5, can be assessed to identify and potentially remove unnecessary measures in the conflict-free schedule. Furthermore, the removal of the identified unnecessary measures also denotes ascertaining the positive fitness, which may be attained by their complete removal from the schedule. This subsection provides a detailed discussion regarding the identification as well as the removal of unnecessary measures within a conflict-free schedule and the means to ascertain their positive fitness.

At the outset, since unnecessary measures are directly related to the predefined conflict solution alternatives utilized within the CDCR process, all elemental conflict solutions summarized in table 6.3 supporting the capability to address the four vehicle-specific conflict types (i.e. occupancy, infrastructure availability, circulation and service conflicts) handled in the dynamic DRP deployment system can be considered (see subsection 6.5 and 11.4). Overall, there are six vehicle-specific elemental conflict solution alternatives that have been implemented within the vehicle-specific and automatic CDCR process:

- Shifting trains in time - STT (see subsection 6.3.8)
- Rerouting trains – RRT (see subsection 6.3.11)
- Early turning trains – ETT (see subsection 6.3.6)
- Developing an alternative train service – ATS (see subsection 6.3.12)
- Cancellation of a train service – CS (see subsection 6.3.5)
- Transference of passengers' waiting time – TPW (see subsection 6.3.13)

All six elemental conflict solutions have been implemented to address one or more of the vehicle-specific conflict types during the CDCR process (see subsection 11.4 and 11.5). Therefore, every single one of the six elemental conflict solutions has the potential to be identified as an unnecessary measure (see subsection 3.7.2). However, depending on the computational effort available, the schedule adjustment process can be limited to identify unnecessary measures only for certain elemental conflict solution alternatives.

Initially, the first four elemental conflict solution alternatives on the list, namely, STT, RRT, ETT, and ATS, have been utilized to solve occupancy, infrastructure availability and circulation conflicts, and are central to support the adjustment of the schedules. However, there are certain aspects that must be taken into account regarding the handling of the cancellation of train services (CS) and the transference of passengers' waiting time (TPW). As detailed in the CDCR approach (see section 11), any measure which involves the total or partial cancellation of train services at certain locations in the network (e.g. ETT or ATS) is handled within the framework of service conflicts. Service conflicts are resolved by solely through the transference of passengers' waiting time. Additionally, the cancellation of train services (CS) is also the result of the assembly of the PVSCS combination under investigation (see subsection 11.3). Since the transference of passengers' waiting time (TPW) is handled as the product of other elemental conflict solutions or the investigated PVSCS combination as a whole, the cancellation of train services cannot be directly considered as an unnecessary measure.

As a result, the dynamic DRP deployment system's standard approach recommends supporting the remaining four vehicle-specific elemental conflict solutions, namely, STT, RRT, ETT, and ATS, to identify unnecessary measures and consider in parallel their incidence on the TPW.

As depicted in figure 13.2, unnecessary measures are identified for every conflict resolution alternative RS_{C_f} contained within the set $Sol_{I_{S,o}}$ (see subsection 11.3.2), considering all five elemental conflict solutions. Once an unnecessary measure NC_f is identified (i.e. taking the existence of third trains into consideration) the time of its occurrence must be registered. According to the registered time of occurrence the unnecessary measure NC_f is included in the list $NL_{NC_{I_{S,o}}}$, which is updated every time an unnecessary measure is removed. After an unnecessary measure is selected from the list, its removal is projected and its positive fitness $NR(NC_f)$ established considering any immediate effect on the TPW.

The following subtitles discuss the identification, removal, and assertion of the positive fitness of every unnecessary measure that is to be supported by the schedule adjustment process. The handling of unnecessary measures is detailed for each one of the five central elemental conflict solutions, as recommended by the dynamic DRP deployment system's standard approach.

Unnecessary Shifts in Time (Waiting Times)

As discussed in subsection 2.2.3, unnecessary shifts in time are understood as any waiting time in a train's schedule, which has been introduced by a conflict resolution and given the resulting operating situation (i.e. once the schedule has been made conflict-free) is no longer operationally relevant. This subtitle provides a detailed account regarding the handling of unnecessary waiting times introduced by a conflict resolution RS_{C_f} that was chosen in the CDCR process.

The subtitle first discusses a generalized approach to identify unnecessary waiting times in every RS_{C_f} registered in the set $Sol_{I_{S,o}}$. Later, a discussion on the removal of the identified unnecessary measure NC_f from the train's schedule is conducted. Finally, an approach to assert the positive fitness $NR(NC_f)$ of removing unnecessary waiting times from the schedule is provided.

Identification

The unnecessary waiting times NC_f are identified for every train $T_{I_{S,i}}$ that has been shifted in time as part of a conflict resolution RS_{C_f} registered in the set $Sol_{I_{S,o}}$.

The identification process relies on two benchmarks to verify the existence and magnitude of an unnecessary waiting time for every train handled within a particular conflict resolution. The utilized benchmarks are the operational constraints between the trains (e.g. minimum headway times, minimum transition time between train services), and each train's original schedule.

While the operational constraints are a generalized benchmark within the system, it is still necessary to explicitly define which schedule is to be utilized as a benchmark for the identification of unnecessary waiting times. Initially, it must be considered that every train's PVSCS $d_{T_{I_{S,i}}}$ used in the PVSCS combination has been developed through a baseline-PVSCS. The baseline-PVSCS takes into consideration each train's operating situation at the beginning of the disruption as well as the DRP operating concept of its line and incorporates this information within the framework of the train service's schedule that the investigated train had originally appointed (see subsection 9.5.1). Therefore, since the original schedule introduced in section 5 would not be able to represent

the best attainable operating circumstances for every train service anymore, the train's PVSCS $d_{T_{l_s,i}}$ used in the PVSCS combination is utilized as the respective benchmark.

The identification of unnecessary waiting times in each conflict resolution RS_{C_f} in the set $Sol_{l_s,o}$ is carried by verifying the possibility to reduce or eliminate the waiting time appointed to a train by the STT. The identification compares the waiting time $t_{w.RSC_f T_{l_s,j}}$ appointed to a train $T_{l_s,j}$ by the chosen conflict resolution and compares it with the waiting time which is required within the actual operating circumstances utilizing the two benchmarks discussed above; namely, the operational constraints and the train's PVSCS $d_{T_{l_s,i}}$, as reference.

To ascertain the required waiting time, equation 13.1 provides a generalized example for its identification. Equation 13.1 generalizes the means to determine the necessary waiting time $t_{w.Req T_{l_s,j}}$ for a train $T_{l_s,j}$ which has been previously appointed with an STT to address an occupancy conflict in a link with a train $T_{l_s,i}$. Equation 13.1 is a modified version of equation 11.1 (see subsection 11.4.1) and asserts the necessary waiting time by considering the minimum value between the actual operating circumstances, the train's original PVSCS $d_{T_{l_s,j}}$, and the existence of third trains $T_{l_s,k}$.

$$t_{w.Req T_{l_s,j}} = \min \left\{ \begin{array}{l} \left(t_{Proj.Dep T_{l_s,j}}^{S_a} - t_{Proj.Dep T_{l_s,i}}^{S_a} \right) - t_{min HT}^p_{MT_i - MT_j} \\ \left(t_{Sched.Dep T_{l_s,j}}^{S_a} - t_{Proj.Dep T_{l_s,i}}^{S_a} \right) - t_{min HT}^p_{MT_i - MT_j} \\ \left(t_{Proj.Dep T_{l_s,j}}^{S_a} - t_{Proj.Dep T_{l_s,k}}^{S_a} \right) - t_{min HT}^p_{MT_k - MT_j} \\ \left(t_{Proj.Dep T_{l_s,j}}^{S_a} - t_{min.Dep T_{l_s,j}}^{S_a; Q-R} \right) \end{array} \right. \quad (13.1)$$

By taking into consideration a third train $T_{l_s,k}$ or any potential transition between train services $t_{min.Dep T_{l_s,j}}^{S_a; Q-R}$, the approach is able to account for any follow-up conflict (i.e. the immediate effect on other trains). It must be noted that the departure time of train $T_{l_s,j}$ to ensure the transition between train services $t_{min.Dep T_{l_s,j}}^{S_a; Q-R}$ takes into account the minimum transition time which may be ascertained by considering equation 11.4.

Ultimately, to verify the existence of an unnecessary waiting time NC_f , the difference between the waiting time appointed by the conflict resolution alternative $t_{w.RSC_f T_{l_s,j}}$ and the waiting time required under the current operating circumstances $t_{w.Req T_{l_s,j}}$ must be larger than zero. This relation is generalized in equation 13.2, and if it is satisfied, an unnecessary waiting time $t_{w.Adj T_{l_s,j}}$ has been positively identified.

$$t_{w.RSC_f T_{l_s,j}} - t_{w.Req T_{l_s,j}} > 0 \quad (13.2)$$

Similar to the identification of occupancy conflicts (see subsection 11.4.1), the temporal occurrence of the identified unnecessary measure NC_f is registered as the scheduled arrival time of the train appointed with the waiting time $T_{l_s,j}$ to its waiting location (e.g. platform track, entrance to a node). The identification of the unnecessary waiting times for the rest of the conflict

types, namely, infrastructure availability and circulation conflicts, is advanced under the same principles discussed for the occupancy conflict cases.

Removal

Aligned with the overall approach, the removal of unnecessary measures is equivalent to the development of conflict resolution alternatives in the CDCR process. By including a third train in the consideration, the schedule's adjustment is able to ascertain if it is able to totally or partially remove the unnecessary waiting time.

The removal is conducted by ascertaining the magnitude of the unnecessary waiting time $t_{w.Adj_{T_{l_s,i}}}$ and projecting its complete removal of along the train service's route. Equation 13.3 supports the capability to ascertain the magnitude of the unnecessary waiting time $t_{w.Adj_{T_{l_s,j}}}$ that can be removed, which is ascertained by introducing minor modifications to equation 13.2.

$$t_{w.RSC_f_{T_{l_s,j}}} - t_{w.Req_{T_{l_s,j}}} = t_{w.Adj_{T_{l_s,j}}} \quad (13.3)$$

With the magnitude of the waiting time identified, the train's waiting time is removed from the schedule and projected throughout the remaining portions of its route. The removal and projection of the operating situation lay the groundwork for the identification and subsequent handling of the induced follow-up conflicts, as detailed by the approach described in figure 13.2. The follow-up conflicts and their assessment are handled as discussed in subsection 11.3.2 and 12.2.2.

Determine the Positive Fitness

Determining the positive fitness attained by the removal of the unnecessary waiting time $NR(NC_f)$ allows ascertaining if its removal provides an actual benefit (i.e. positive fitness) to the schedule's overall fitness. If the complete removal does not bring any benefit to the fitness of the schedule (see figure 13.2), the partial removal of the unnecessary waiting time $t_{w.Adj_{T_{l_s,j}}}$ can be ascertained by incorporating optimization methods (e.g. Simulated Annealing), like the ones discussed in subsection 3.5.1. If neither the total nor the partial removal of the unnecessary measure bring any benefit to the fitness of the schedule (see figure 13.2), the next unnecessary measure in the list $NL_{NC_{l_s,0}}$ is investigated without introducing any previous adjustment in the schedule, as shown in figure 13.2. In case of unnecessary shifts in time,

The positive fitness attained by the removal of the unnecessary waiting times can be ascertained as for any other expected relative-time change (see subsection 12.3.1). However, since there is only one alternative whose follow-up conflicts are immediately handled once the unnecessary measure has been removed (see figure 13.2), the assessment may solely focus on the affected train and not on its influence on the transition train services specified in its adjusted circulation plan (see subsection 12.3.1). Therefore, the positive effect on the partial fitness of the PVSCS combination introduced by the adjustment of the schedule after removing the unnecessary waiting time is determined through a modified version of equation 12.41 (see subsection 12.4.1).

$$NR(NC_f) = t_{w.Adj_{T_{l_s,j}}} * w_1 \quad (13.4)$$

Equation 13.4 allows ascertaining the positive fitness attained by the removal of the unnecessary waiting time from the schedule. As foreseen by the approach outlining the schedule's adjustment,

the positive fitness induced by removing the unnecessary measure is to be compared with the required modifications introduced in the schedule to address the induced follow-up conflicts (see figure 13.2 – step 6). Ultimately, this would allow deciding whether to remove or maintain the assessed portion (i.e. $t_{w.Adj_{T_{l_s,j}}}$) of the unnecessary waiting time for the investigated train.

Unnecessary Train Rerouting

As discussed in subsection 3.7.2 and due to the focus on passenger railways, unnecessary train rerouting within a node take place when a train, which has had its platform track changed during the CDCR process, maintains the change although it is no longer relevant in the present operating situation. This subtitle provides a detailed account regarding the handling of unnecessary platform track changes introduced by a conflict resolution RS_{C_f} in the CDCR process.

First, a generalized approach to identify the unnecessary platform track changes in every RS_{C_f} registered in the set $Sol_{l_s,o}$ is discussed. Later, an approach supporting the removal of the unnecessary measure NC_f from the respective trains' schedules is derived. Finally, an approach to assert the positive fitness $NR(NC_f)$ that may be attained by removing unnecessary platform track changes from the schedule is established.

Identification

Unnecessary platform track changes are identified for every train $T_{l_s,i}$ which has been rerouted (RRT) through a node as foreseen in the respective conflict resolution.

Different considerations can be advanced to determine under which operational circumstances the use of a different platform track is deemed to be no longer relevant (i.e. unnecessary platform track change). One potential alternative can be advanced by considering every foreseen platform track change to be potentially unnecessary. Another alternative may be attained through the structuring of a framework that identifies unnecessary platform track changes in correspondence to the actual operating situation at each of the stations.

While platform track changes are essential to upholding the quality of the operations, particularly concerning passengers' welfare, their impact is not as dire as the cancellation of a train service at a station. Furthermore, it must be considered that platform track changes are appointed in the CDCR process to address different conflict types (see subsection 11.5). Therefore, removing what it may be considered an unnecessary platform track change would only be beneficial if it is possible to ensure that it does not come in detriment of the operating situation.

Given that at this juncture, the schedule is already conflict-free, a detriment in the operating situation may be easily induced. Furthermore, as it has been discussed in subsection 11.5.1, addressing occupancy conflicts in nodes, particularly multi over-occupation conflicts, is potentially a convoluted task. Therefore, generating follow-up occupancy conflicts in nodes may be utilized as a benchmark to identify the existence of unnecessary platform track changes.

As a result, the identification of unnecessary platform track changes is conducted for every train that has been rerouted through a node by projecting its occupancy of the platform track appointed in its PVSCS $d_{T_{l_s,i}}$ and verifying this with the current operating situation. The contrast with the operating situation permits to identify any follow-up occupancy conflicts with third trains in the node (i.e. single or multi over-occupation, see subsection 11.4.1).

Depending on the computational effort available, the induced follow-up conflicts can be limited to: no conflicts, single and multi over-occupation conflicts. Contrasting the complexity of the operating situation that may be induced versus the overall benefit to the solution quality, as a standard approach recommended for the dynamic DRP deployment system, unnecessary platform exchanges are positively identified only when the removal of the platform track exchange generates no follow-up occupancy conflicts in the node (see subsection 11.4.1).

Ultimately, the temporal occurrence of a positively identified unnecessary platform track change NC_f is registered as the scheduled arrival of the train to the node where the rerouting wants to be conducted.

Removal

The removal of the unnecessary platform track changes is conducted by ascertaining the magnitude of the expected relative-time change product of the projected routing of the train towards the platform track appointed by its PVSCS $d_{T_{l_s,i}}$.

As discussed during the development of the conflict resolution alternatives that include an RRT, the rerouting of a train through a node entails considering different routing alternatives. While an exploration of different routing alternatives may also be a possible approach to remove unnecessary platform track changes from the schedule, only alternatives that allow the train to uphold its schedule (reach all subsequent nodes utilizing the Matrix of Reachability – see subsection 5.1.1) are considered. Additionally, in order to take into account follow-up conflicts with third trains in the succeeding track only alternatives that permit to include a necessary waiting time at the platform track (utilized by the route alternative) and support a conflict-free departure of the train without generating any occupancy conflict are taken into consideration. In case more than one routing alternative supports the established requirements, the route which projects the minimum relative-time change vis-à-vis the train's PVSCS $d_{T_{l_s,i}}$ is considered first.

To ascertain the projected relative-time change product of routing the train towards its planned platform track $\Delta t_{Proj-Adj-T_{l_s,i}}$, equation 13.5, which is already a generalized version of equation 2.9 introduced in subsection 2.2.3, is slightly modified to support the train's route adjustment within the node. As it is possible that there are further operational tasks to be fulfilled at the node (e.g. transition between train services), the expected relative-time change is ascertained by contemplating the train's departure time from the platform track in question. Therefore, the expected relative-time change is calculated by subtracting the scheduled departure time $t_{Sched.Dep-T_{l_s,i}}$ from the projected departure time introduced by the route adjustment $t_{Proj.Dep-Adj-T_{l_s,i}}$.

$$\Delta t_{Proj-Adj-T_{l_s,i}} = t_{Proj.Dep-Adj-T_{l_s,i}} - t_{Sched.Dep-T_{l_s,i}} \quad (13.5)$$

The ascertained change in the relative-time is to be projected throughout the train's route, setting the groundwork for the identification and subsequent handling of follow-up conflicts.

Determine the Positive Fitness

Determining the positive fitness attained by removing the unnecessary platform track changes $NR(NC_f)$ allows establishing if the introduced adjustments in the schedule provide an actual benefit to the schedule's overall fitness. If the removal of the unnecessary platform track changes

enhances the fitness of the schedule (see figure 13.2), the adjustments introduced by the removal of the unnecessary measure are maintained. If the removal does not bring any benefit to the fitness of the schedule (see figure 13.2), the next rerouting alternative, considering minimum relative-time change vis-à-vis the train's PVSCS $d_{T_{l_s,i}}$ is considered. If all alternatives have been considered and the removal does not bring any betterment to the fitness of the schedule, the next unnecessary measure in the list $NL_{NC_{l_s,o}}$ is investigated without introducing any previous adjustment in the schedule, as shown in figure 13.2.

The positive fitness attained by removing the unnecessary platform track changes may be ascertained by removing the platform exchange time for passengers and considering the relative-time changes (i.e. positive or negative), which derive from adjusting a train's route through the node. Therefore, the positive effect on the PVSCS combinations' partial fitness after removing an unnecessary platform track change is determined by considering the no longer necessary platform exchange time for passengers, which is counterbalanced by the relative-time change introduced by the adjustment of the train's route through the node.

As a result, the positive fitness $NR(NC_f)$ of removing an unnecessary platform track change results from adding the weighted the relative-time change introduced by the adjustment of the train's route $\Delta RT_{Adj.T_{l_s,i}}$, from the weighted minimum platform exchange time for passengers $min t_{p.Ex.Pt_{S_a}-Pt'_{S_a}}$. Equation 13.6 provides with the generalized means to ascertain the positive fitness attained by removing an unnecessary platform track change.

$$NR(NC_f) = min t_{p.Ex.Pt_{S_a}-Pt'_{S_a}} * w_3 + \Delta RT_{Adj.T_{l_s,i}} * w_1 \quad (13.6)$$

The magnitude of the expected relative-time change introduced by the adjustment of the route $\Delta RT_{Adj.T_{l_s,i}}$ is established as generalized in equation 13.7. As detailed in equation 13.7, the relative-time change introduced by the adjustment of the route $\Delta RT_{Adj.T_{l_s,i}}$ results from subtracting the projected departure of the train from the station as foreseen by currently investigated route adjustment $t_{Proj.Dep-Adj-T_{l_s,i}}$ from the projected departure time of the train from the station foreseen in the conflict-free PVSCS combination $t_{Proj.Dep-T_{l_s,i}}$. The departure time is utilized so as to account for the necessary operational times that take place at the investigated node (e.g. stopping time, a transition between train services, etc.), as they all may produce temporal gains in the adjusted schedule.

$$\Delta RT_{Adj.T_{l_s,i}} = t_{Proj.Dep-T_{l_s,i}} - t_{Proj.Dep-Adj-T_{l_s,i}} \quad (13.7)$$

Finally, as detailed by the approach outlining the schedule's adjustment (see figure 13.2), the positive fitness is compared with the required modifications introduced in the schedule to address any induced follow-up conflicts.

Unnecessary Early Turns

As discussed in subsection 3.7.2, unnecessary early turns take place for trains whose early turning provides no further operational benefit within the actual operating circumstances. This subtitle details the handling of unnecessary early turning of trains introduced by a conflict resolution RS_{C_f} during the CDCR process.

The subtitle first discusses a generalized approach to identify unnecessary early turns utilized in the RS_{C_f} registered in the set $Sol_{I_{S,o}}$. Later, a discussion regarding the removal of the identified unnecessary measures NC_f from the respective trains' schedules is conducted. Finally, an approach to assert the positive fitness $NR(NC_f)$ that may be attained by removing unnecessary early turns from the schedule is discussed.

Identification

Unnecessary early turns are identified for every train $T_{I_s,i}$ that has been appointed an early turn (ETT) during the CDCR process.

Different considerations can be advanced to determine under which operating circumstances the use of an early turn is deemed to be no longer relevant. At the outset, it must be noted that the ETT as an elemental conflict solution is utilized to address multiple conflict types within the CDCR process, namely, occupancy, infrastructure availability and circulation conflicts (see subsection 11.5). Therefore, as with the rerouting of a train, its removal should only be considered beneficial if it is possible to ensure that it does not come in detriment of the operating situation (i.e. observing the influence of its removal on third trains).

Since an early turn mainly involves transferring the occupancy time of a platform track to change a train's driving direction to the platform track at a different station (see subsection 6.3.6), a detriment to the operating situation through the removal of an early turn can be easily induced. Therefore, generating follow-up occupancy conflicts in the nodes where the turn wants to be reinserted may be utilized as a benchmark to identify the existence of unnecessary early turns.

Furthermore, the movement of the train between the early turning station and the station where the turn wants to be reinstated should also be taking into consideration. Additionally, since an early turn involves more than one train service (see subsection 11.5.3), the removal of an early turn would also need to take into consideration that the transition between train services. In this regard, as discussed in subsection 9.7, the transition between train services at end stations is closely associated with a transition to stable operations. Thus, unnecessary early turns may also be determined by verifying the existence of circulation conflicts across the different turning stations that allow extending the reach of the early turned train until its end station (including the LtFTS – see subsections 3.6.2 and 9.5).

As a result, the identification of unnecessary early turns is conducted for every train that has been turned around before it was able to reach its end station by projecting the transition between the involved train services across the unreached nodes in its schedule. The projection of the train would entail considering the movement of third trains between the early turning station and the unreached station (similarly as discussed for the unnecessary shift of a train in time). Furthermore, projecting the train's arrival time at a platform track in the unreached station so that it is able to support its schedule (i.e. driven in, turn around, and drive out of the turning station) while it does not generate any follow-up occupancy conflict in the platform track (i.e. single or multi over-occupation, see subsection 11.4.1). Finally, it is also essential to project the departure time of the train after its turn from the train station, while considering the movement of third trains as discussed above.

Unnecessary early turns are identified as generalized in equation 13.8, where a difference between the projected arrival of the train to the unreached turning station and its projected departure after the transition between train services is larger than the minimum transition time plus the transition

time supplement discussed in subsection 12.3.1. Given that the identification is based on projections, the supplement transition time $t_{Trans.Add}$ is included to account for the stochastic nature of the transition between train services within disrupted operations. If more than one turning station has been left unreached due to the early turn, the turning of the train at the different alternatives (i.e. unreached stations) is investigated.

$$t_{Proj.Dep\ R}^{S_a} - t_{Proj.Arr\ T_{l_s,i}}^{S_a} > \min t_{Trans} + t_{Trans.Add} \quad (13.8)$$

Ultimately, aligned with a CDCR principle, the temporal occurrence of the identified unnecessary measure NC_f is registered as the scheduled arrival time of the train $T_{l_s,i}$ to its early turning station.

Removal

In the particular case of the unnecessary early turns, the adjustment to be introduced in the schedule entails reinstating the train's turn at one of its unreached stations. For this, the respective spatiotemporal information for the train is to be projected in the schedule from the moment the train arrives at the early turning station in direction to the unreached station until it arrives at the early turning station driving in the opposite direction (i.e. after the transition between train services). Considering the overall approach guiding the schedule adjustment process, the necessary adjustments on the schedule are introduced, taking into consideration follow-up conflicts with third trains. As conducted in the identification, if more than one turning station has been left unreached due to the early turn, the turning of the train at the different alternatives (i.e. unreached stations) is investigated.

More specifically, the spatial information to be adjusted and introduced in the schedule concentrates on projecting any necessary modification to the train's route through the early turning station while securing its capability to reach the platform track at an unreached turning station under investigation as foreseen in the train's schedule. Furthermore, the temporal information to be adjusted and introduced in the schedule is constituted by the arrival and departure times from the respective nodes (i.e. early turn station) while taking into consideration changes in routes, follow-up conflicts as described above, and the transition between train services. Therefore, to support the removal of an unnecessary early turn, two general steps are required.

First, at the spatial level, the capability to reinsert the train's planned route through and from the early turning station until the unreached turning station under investigation, is verified. If the use of the train's original planned route does not induce follow-up conflicts with other trains, the route may be immediately adjusted. However, if the adjustment produces follow-up conflicts across specific links or nodes, the capability of the train to reach the stations in its schedule through different route alternatives is explored utilizing the Matrix of Reachability (see subsection 5.1.1). The same must be conducted for the train driving back from the unreached turning station under investigation until the early turning station. Depending on the computational effort available, the routing alternatives in both directions that induce follow-up conflicts can be limited to: no conflicts, single or multi over-occupation conflicts. Thus, according to the ability to generate further routing alternatives, the handling of the identified unnecessary measure may be terminated if no alternative has been generated.

Second, depending on the alternative route taken between the early turning station and the unreached turning station under investigation, the train's arrival and departure from the nodes as well as the temporal influence on the transition train service appointed by its adjusted circulation

plan, are projected (considering the handling of follow-up conflicts). The temporal adjustment is highly dependent on the route that is appointed to the train so that it is able to reach the platform track at the unreached station under investigation and its ability to leave the turning station without having to wait for a long time to support the movement of third trains, as discussed in the previous subtitle.

Once the necessary spatiotemporal adjustments have been established, the projected relative-time change $\Delta t_{Proj-Adj-T_{l_s,i}}$ product of reintroducing the train's capability to reach a platform track at the unreached station under investigation is ascertained.

As a result, the expected relative-time change from the moment the train arrives at the early turning station after the transition between the involved train services has been conducted (i.e. driving in the opposite direction), is computed as detailed in equation 13.5. Equation 13.5, would support the establishment of the expected relative-time change $\Delta t_{Proj-Adj-T_{l_s,i}}$ between the original schedule (i.e. the train's PVSCS) $t_{Sched-T_{l_s,i}}$ and the projected adjustments $t_{Proj-Adj-T_{l_s,i}}$.

In case more than one routing alternative has been verified for every unreached station under investigation, the one that generates the minimum relative-time change vis-à-vis the train's $d_{T_{l_s,i}}$ is considered first. Additionally, if more than one unreached station is being investigated, the end station is considered first. If no routing alternatives being investigated reach the end station, the turning station the closest to the end station is investigated first.

Ultimately, as discussed in the handling of previous unnecessary measures, the projection would allow ascertaining the follow-up conflicts that need to be addressed in subsequent processes, as detailed in figure 13.2 in the adjustment proposed approach.

Determine the Positive Fitness

Determining the positive fitness attained by the removal of unnecessary early turning of trains $NR(NC_f)$ allows ascertaining if the adjustments which have been introduced deliver an actual benefit to the schedule's overall fitness. If the removal enhances the fitness of the schedule, the adjustments introduced by the removal of the unnecessary measure are maintained. If the removal does not bring any benefit to the fitness of the schedule (see figure 13.2), the next routing alternative, considering the relative-time change vis-à-vis the train's PVSCS $d_{T_{l_s,i}}$ is investigated. If the removal considering all routing alternatives ascertained for an unreached station does not bring any benefit to the fitness of the schedule (see figure 13.2), the next unreached station is investigated. If the removal does not bring any benefit to the fitness of the schedule (see figure 13.2), the next unnecessary measure in the list $NL_{NC_{l_s,o}}$ is investigated without previously introducing any adjustment in the schedule, as depicted in figure 13.2.

The positive fitness of removing the unnecessary early turns may be ascertained by considering the potential removal of any platform track change, the induced reduction in the transferred passenger's waiting time and the modification on the relative-time change (i.e. positive or negative) which derives from introducing the spatiotemporal adjustments. Therefore, the positive influence on the PVSCS combinations' partial fitness is determined by considering any platform exchange times for passengers as well as the reduction in the transferred passengers' waiting time and counterbalanced by the relative-time change introduced by the modifying the train's route through nodes and tracks.

Equation 13.9 generalizes the means to ascertain the positive fitness $NR(NC_f)$, which results from subtracting the weighted the relative-time change introduced by the adjustment of the train's route $\Delta RT_{Adj.Tl_{S,i}}$ from any weighted minimum platform exchange time for passengers $min t_{P.Ex.Pt_{S_a-Pt'_{S_a}}}$ and the weighted reduction in the transferred passenger's waiting time $t_{PW,Adj_{RS_{C_f}}}^{S_a}$ across all stations affected by the early turn.

$$NR(NC_f) = min t_{P.Ex.Pt_{S_a-Pt'_{S_a}}} * w_3 + \sum_{S_a} t_{PW,Adj_{RS_{C_f}}}^{S_a} * w_4 + \Delta RT_{Adj.Tl_{S,i}} * w_1 \quad (13.9)$$

The magnitude of the expected relative-time change introduced by the adjustment of the train's route $\Delta RT_{Adj.Tl_{S,i}}$ is established as generalized in equation 13.7 (see unnecessary rerouting).

To ascertain the reduction in the transferred passenger's waiting time $t_{PW,Adj_{RS_{C_f}}}^{S_a}$, the already assessed passengers' waiting time $t_{PW,RS_{C_f},Q-R}^{S_a}$ corresponding to the partial cancellation of the train service due to the early turn which affected stations S_a and registered in the set $Sol_{l_{S,o}}$ is adjusted to include a reinstatement of the train's service at the affected stations. Equation 13.10 allows ascertaining the reduction in the transferred passenger's waiting time $t_{PW,Adj_{RS_{C_f}}}^{S_a}$ by means of a difference between the already assessed TPW $t_{PW,RS_{C_f},Q-R}^{S_a}$ and the operating situation at the station influenced by reinstating the train service at the station. The induced operating situation is ascertained by the absolute value of the difference between the projected departure time $t_{Proj,Dep}^{S_a}$ of the reinstated train service Q after its stop and the departure of the previous train service $t_{Proj,Dep}^{S_a}$ plus the maximum service interval $t_{SI,max_{Q,DRP,l_{S,v}}}$ corresponding to the line of the reinstated train (see subsection 11.5.4). To guarantee that the assessment takes into consideration the actual operating situation at the affected station, the prior train service must be recognized as discussed in subsection 6.3.13.

$$t_{PW,Adj_{RS_{C_f}}}^{S_a} = t_{PW,RS_{C_f},Q-R}^{S_a} - \left| t_{Proj,Dep}^{S_a} - (t_{Proj,Dep}^{S_a} + t_{SI,max_{Q,DRP,l_{S,v}}}) \right| \quad (13.10)$$

Finally, as foreseen by the approach outlining the schedule's adjustment (see figure 13.2), the positive fitness is compared with the required modifications introduced in the schedule to address any induced follow-up conflicts.

Unnecessary Use of an Alternative Train Service

This subtitle provides a detailed account regarding the unnecessary use of an alternative train service as foreseen by a conflict resolution RS_{C_f} that was introduced in the CDCR process.

The subtitle first discusses a generalized approach to identify, the unnecessary use of an alternative train service in every RS_{C_f} registered in the set $Sol_{l_{S,o}}$. Later, a discussion on the removal of the identified unnecessary measure NC_f from the train's schedule is conducted. Finally, an approach to assert the positive fitness $NR(NC_f)$ of removing the unnecessary use of alternative train services from the schedule is provided.

Identification

The unnecessary use of alternative train services (ATS) is identified for every train $T_{l_s,i}$ which has had its schedule modified as foreseen by the respective conflict resolution RS_{C_f} .

At the outset, the development of an alternative train service is reserved for addressing a specific kind of circulation conflict that takes place at stations within the critical area (i.e. positive turns – see subsection 11.4.1). This particular kind of circulation conflict is identified so that the automatic CDCR process has the opportunity to remove a train from a station before its scheduled departure time, and thus, limit the capacity consumption of the train at the platform track. As discussed in subsection 11.5.3, the measure ATS is only implemented in cases when equation 11.12 is fulfilled (see subsection 11.5.3).

Considering the operating context in which the measure is implemented (i.e. to avoid an idle occupancy of the platform track at stations which are critical for the stability of the whole system), the unnecessary use of an alternative train service may be identified by means of two benchmarks. A first benchmark based on equation 11.12 would allow identifying the unnecessary use of an alternative train service due to changes in the operating situation (i.e. a no longer existing positive turn, see subsection 3.6.2). Furthermore, considering that the schedule is already conflict-free, a second benchmark may allow to identify the unnecessary use of an alternative train service by ascertaining a train's capability to wait for its scheduled departing time at the platform track without causing any detriment to the operations in the station (i.e. observing the influence of its removal on third trains).

As it has been discussed for the identification of unnecessary platform tracks changes, follow-up occupancy may be utilized to determine if a detrimental influence on the operating situation has been induced by removing a potentially unnecessary measure. Given that the handling of the disrupted operations has proven to be particularly composite within the critical area (i.e. the existence of queueing trains and abiding by the entrance sequences to the LtFTS), any modification in the operating situation is particularly sensitive as they have the potential to influence a large number of trains. Therefore, considering the occupancy conflicts across all nodes and links utilized in the alternative train service may allow ascertaining that the measure has the potential to be removed without causing any particularly detriment in the operating situation.

As a result, the two benchmarks introduced above are utilized to identify the unnecessary use of an alternative train service.

According to the first benchmark, the unnecessary use of an alternative train service is identified if the scheduled departure of the alternative train service R from the station S_a corresponding to the conflict-free schedule is larger than the scheduled departure time $t_{Sched.Dep}^{S_a}$ from the station S_a of train $T_{l_s,i}$ originally foreseen in its PVSCS $d_{T_{l_s,i}}$. Therefore, an unnecessary alternative train service is positively identified if the relation in equation 13.11 is fulfilled.

$$t_{Sched.Dep}^R > t_{Sched.Dep}^{S_a} \quad (13.11)$$

Equation 13.11 generalizes the means to identify an unnecessary alternative train service in cases where the positive turn is no longer existent.

According to the second benchmark, the unnecessary use of an alternative train service can also be identified if an extension of the occupancy time at the platform track by the train affected by

the use of an alternative train service does not induce any follow-up conflict with third trains. The occupancy time of the platform track by the train affected by the use of an alternative train service must be extended until the scheduled departure time from the station S_a originally foreseen for train $T_{l_s,i}$ in its PVSCS $d_{T_{l_s,i}}$. Depending on the computational effort available, the induced follow-up conflicts can be limited to: no conflicts, single or multi over-occupation conflicts.

Aligned with a CDCR principle, the temporal occurrence of the identified unnecessary measure NC_f is registered as the scheduled departure time $t_{Sched.Dep}^{S_a}$ of the alternative train service R from the station S_a where the alternative train service is being originated (i.e. the station in which a positive turn was identified).

Removal

In the case of an unnecessary use of an alternative train services, the unnecessary measure is removed by reinstating the cancelled portions of the original train service in the schedule. Restoring the original train service entails re-establishing the service capabilities and projecting the movement of the train throughout portions of its route that have been cancelled due to the development of an alternative train service (see subsection 6.3.12).

Different from any of the previous cases, the adjustment of the schedule would be conducted separately depending on the benchmark with which the use of an alternative train service has been identified as being unnecessary.

In case the unnecessary use of an alternative train service has been identified according to the first benchmark, the adjustment of the schedule only requires reinstating the train service number across the portion of the train's route, which has been cancelled due to the use of the alternative train service. Since the departure time of the train service from the station S_a has been ascertained to be larger than departure time originally foreseen for train $T_{l_s,i}$ in its PVSCS $d_{T_{l_s,i}}$, only the train service number is reinstated, and no further spatiotemporal adjustments need to be included (i.e. no follow-up conflicts are generated).

In case the alternative train service has been identified according to the second benchmark, the adjustment to be introduced in the schedule entails reinstating the train's service from the station S_a where the alternative train service is being originated until the last station reached by the alternative train service. For this, the respective spatiotemporal information for the train is to be projected in the schedule from the moment the train departs from the station S_a until it arrives at the last station reached by the alternative train service. As discussed during the structuring of the approach guiding the schedule adjustment process (see subsection 13.3.1), the necessary adjustments on the schedule are introduced, taking into consideration follow-up conflicts with third trains.

To support introducing the necessary adjustments in the schedule, the two general steps discussed for the removal of an early turn are also utilized. The first step entails an exploration at the spatial level, looking for alternative routes and starting with the train's planned route. Second, depending on the route alternatives, the train's arrival and departure from the nodes are projected (considering the handling of follow-up conflicts).

Once the necessary spatiotemporal adjustments have been established, the projected relative-time change $\Delta t_{Proj-Adj-T_{l_s,i}}$ product of reintroducing the train's capability to service its route is ascertained.

In case more than one routing alternative has been verified for every unreached station under investigation, the one that generates the minimum relative-time change vis-à-vis the train's $d_{T_{l_s,i}}$ is considered first. Ultimately, as discussed in the handling of previous unnecessary measures, the projection would allow ascertaining the follow-up conflicts that need to be addressed in subsequent processes, as detailed in figure 13.2 in the adjustment proposed approach.

Determine the Positive Fitness

Determining the positive fitness attained by removing the unnecessary use of an alternative train service $NR(NC_f)$ allows ascertaining if the adjustments which have been introduced deliver an actual benefit to the schedule's overall fitness. However, since the adjustment of the schedule is foreseen to be conducted separately depending on the benchmark with which the use of an alternative train service has been identified as being unnecessary, the positive fitness is also established separately for the different benchmarks.

In case the unnecessary use of an alternative train service has been identified according to the first benchmark and considering that the removal of the alternative train service does not require any spatiotemporal adjustments, the positive fitness $NR(NC_f)$ can be attained by means of one single attribute. The positive effect on the PVSCS combinations' partial fitness introduced by removing the unnecessary use of an alternative train service is ascertained by reinstating the original train service throughout all the stations within the portion of the train's route, which needed to be cancelled. Therefore, the framework already introduced to establish a weighted reduction in the transferred passenger's waiting time $t_{PW,Adj_{RSC_f}}^{S_a}$ across all affected stations generalized in equation 13.10 may be directly utilized. As a result, equation 13.12 allows ascertaining the positive fitness of removing the unnecessary use of an alternative train service covering different portions of the train's route. Since the reinstatement of the train service does not induce any follow-up conflicts, the removal may most certainly lead to an enhancement of the fitness of the schedule.

$$NR(NC_f) = \sum_{S_a} t_{PW,Adj_{RSC_f}}^{S_a} * W_4 \quad (13.12)$$

In case the alternative train service has been identified according to the second benchmark, the positive fitness of removing the unnecessary use of an alternative train service may be ascertained with the approach already introduces for early turns. Therefore, the positive fitness considers the potential platform track changes, the induced reduction in the transferred passenger's waiting time and the modification on the relative-time change (i.e. positive or negative), which derives from introducing the spatiotemporal adjustments through the node(s). Therefore, the positive influence on the PVSCS combinations' partial fitness is determined by equation 13.9, which generalizes the means to ascertain the positive fitness $NR(NC_f)$.

If the removal of the unnecessary use of an alternative train service identified according to the second benchmark enhances the fitness of the schedule, the adjustments introduced by the removal of the unnecessary measure are maintained. If the removal does not bring any benefit to the fitness of the schedule (see figure 13.2), the next routing alternative, considering the relative-time change vis-à-vis the train's PVSCS $d_{T_{l_s,i}}$, is considered. If the removal does not bring any benefit to the fitness of the schedule (see figure 13.2), the next unnecessary measure in the list $NL_{NC_{l_s,o}}$ is investigated without previously introducing any adjustment in the schedule, as depicted in figure 13.2.

13.3.3. Employment of the Existing CDCR Process and Assessment Module

As it has been discussed in subsection 13.3.1, the adjustment of the conflict-free schedules must support the handling of conflicts that are engendered due to the removal of the identified unnecessary measures. This subsection provides a general discussion regarding the incorporation of the existing CDCR process and assessment modules within the schedule adjustment approach to support the handling of the induced follow-up conflict.

The handling of the follow-up conflicts has two main objectives within the schedule adjustment process. Primarily, it allows returning the schedule to its conflict-free condition during the handling of every positively identified unnecessary measure. Furthermore, it also permits to ascertain the fitness of the conflict resolutions utilized to return the schedule to its conflict-free condition after the removal of an unnecessary measure. Consequently, the handling of follow-up conflicts allows deciding whether to maintain or remove the identified unnecessary measure from the schedule and guarantee that the conflict-free condition of the PVSCS combination is upheld.

Each of the employed modules, namely the automatic CDCR process and the assessment, contributes to fulfilling the handling of follow-up conflicts.

The CDCR process allows developing different conflict resolution alternatives to address any of the follow-up conflicts induced by removing an unnecessary measure. Depending on the computational effort available, the development of the conflict resolution alternatives within the CDCR process can be expressly modified before it is included in the schedule adjustment approach. Certain aspects of the standard process detailed in section 11 may be adjusted as required by the implementing filed. To single-out, the specific processes within the standard CDCR process that have the potential to be adjusted, a top-down consideration of the module's structure can be utilized (see subsection 11.3).

Initially, the CDCR process detailed in section 11 handles four different types of vehicle-specific conflicts (i.e. occupancy, infrastructure availability, circulation and service conflicts), which are, in most cases, broken down even further in different conflict kinds. While limiting the handling of certain conflict types and/or even certain conflict kinds within the CDCR process is a possibility, such limitations would drastically restrict the comprehensive handling of the follow-up conflicts and further curtail the quality of the attained conflict resolutions solutions.

Furthermore, the CDCR process utilizes the six vehicle-specific elemental conflict solutions introduced in subsection 11.5 and already discussed in subsection 13.3.2, to develop its conflict resolution alternatives. Thus, another alternative may be restricting the elemental conflict solutions utilized to develop the conflict resolution alternatives or limiting the ability to combine them as detailed in the respective processes discussed in subsection 11.5. Imposing such limitations may have a much milder impact on the handling of conflicts as the one induced by restricting the handling of entire conflict types. This is due to a trade-off between leaving aside the exploration of potential solutions that may allow developing better solutions vis-à-vis, neglecting the existence of entire conflict types. Consequently, if any limitations on the CDCR process are to be imposed, it is better to concentrate them on the generation of the conflict resolution alternatives.

By the same token, the assessment of the conflict resolution alternatives supports the capability to assess and select the conflict resolution alternatives developed in the CDCR process. Within each determining variable discussed in subsection 12.3, specific features that may be modified to adjust the assessment according to the computational effort available have been highlighted. All the

highlighted features within the determining variables can be considered to establish an assessment structure within the schedule adjustment approach that better satisfies the system's implementing filed and the computational effort available.

As a result, to ensure that the comparison between the adjustments introduced in the schedule and the conflict resolutions required to address any induced follow-up conflicts can be made objectively, it is recommended that the structure of both the CDCR process and assessment module remains unaltered. Under these circumstances, unaltered would entail that the CDCR process and assessment module utilized within the schedule adjustment approach support the same abilities as the ones used to fix the PVSCS combinations.

Consequently, as part of the dynamic DRP deployment system to allow an objective decision regarding whether an unnecessary measure ought to be removed or maintained, both modules should resemble the capabilities foreseen during the fixing of the PVSCS combination.

13.4. Closing Remarks

In this section, a structured approach to support the adjustment and selection of the conflict-free schedules in the converging generation of the Genetic algorithm has been successfully established (see subsection 10.6). Throughout the section, not only the module's general approach but also a detailed discussion of each of its foreseen processes have been introduced. Firstly, a general structure guiding the adjustment and selection process of the conflict-free schedules, which may be adeptly tailored to the available computational effort, has been proposed (see subsection 13.2). Finally, a structured approach further detailing the adjustment of each of the conflict-free schedules resulting from the Genetic algorithm utilizing general principles from the model proposed by Chiang et al. (1998), has been positively derived (see subsection 13.3).

The schedule adjustment and selection module constitute the system's final step, delivering the targeted train number and minute-specific (i.e. with an accuracy of seconds) conflict-free schedule, which is compatible with the actual disrupted circumstances. Overall, the module allows the system to refine the quality of the assembled conflict-free schedules derived by the automatic CDCR process through a spatiotemporal adjustment of every train service, the closest possible to its original schedule and ultimately, updating the schedule's fitness according to the ascertained adjustments. Of particular importance and considering that the system is advanced within a planned disruption-management context, it has been highlighted that the original schedule does no longer provide an overview of the best attainable operating circumstances for every train service. Therefore, the PVSCS selected for every train to assemble the PVSCS combinations are utilized as the original schedule.

The module's structured approach introduced in subsection 13.2 guides the adjustment and selection of the conflict-free schedules in the set corresponding to the population with which the Genetic algorithm detailed in section 10 has fulfilled its termination criteria. The structured approach supporting the adjustment and selection of schedules was derived constructively from the system's overall structure discussed in subsections 3.5.2 and 3.5.3, and targeted towards the handling of a modifiable number of fixed PVSCS combinations in the set so that it is compatible with the available computational effort. The resulting approach is based on the idea that the adjustment of the fixed PVSCS combinations would enhance the quality of the solution provided by the system, which at the same time is dependent on the number of fixed PVSCS combinations being handled by the structured approach. While it has been recommended that the process

handles all the fixed PVSCS combinations in the set provided by the Genetic algorithm, still further investigation is required to ascertain the most effective share of elements within the set to be handled by this last step.

Furthermore, the process for the adjustment of the modifiable number of fixed PVSCS combinations has been advanced following CDCR principles and incorporating the existing CDCR process and assessment module to ensure effective management of any induced follow-up conflicts. Initially, the adjustment of every fixed PVSCS combination foreseen by the proposed approach is constituted by the identification and removal of unnecessary elemental conflict solution measures that have been utilized to develop conflict resolutions to fix each respective PVSCS combination. The removal of each of the positively identified unnecessary measures is assessed for its positive fitness introduced in the schedule and compared to the conflict resolutions which are required to address the potentially induced follow-up conflicts.

With the conflict-free schedules adjusted and the best possible alternative finally ascertained, the system is able to display its proposed solution. Ultimately, the attained solution would fulfill the specific objective and requirements detailed for this *Section* of the work as discussed respectively throughout subsections 3.1, 3.2.2 and 3.2.4.

14. Exemplary Application of the System

14.1. Introduction

This subsection introduces an exemplary implementation of the dynamic DRP deployment system detailed throughout sections 5 to 13 of this work. The exemplary implementation seeks to demonstrate the implementation of the proposed method in an actual disruption and the application of the processes in each of the system's modules utilizing practical data. In consequence, the implementation and application of the different modules of the dynamic DRP deployment system would require information regarding the handling of an actual disruption to conduct the disruption-management as described in the method developed throughout this work.

For advancing the example, an actual disruption scenario within a commuter railway network must be handled by the proposed system. Furthermore, to be able to demonstrate the widest arrange of capabilities of the system, the example should involve a complete blockage in a section of the trunk line of a commuter railway network. By considering a complete blockage within the most utilized section of the network, the effectiveness of the system's modules during the disruption-management would be better represented. Nonetheless, to provide a much more general overview of the general validity of the system, the example would also need to provide a brief overview of the processes for the handling of partial blockages.

This section is organized following the arrangement discussed in subsection 3.5.3; thus, it follows the structure of the different modules that constitute the dynamic DRP deployment system (see figure 3.1). Initially, the commuter railway network and disruption handled in the exemplary implementation, including the DRP operating concept and further operational data (i.e. system's inputs), are detailed in subsection 14.2. Later, according to the process detailed in section 7, the set-up of the introduced DRP operating concept within the disruption is shown in subsection 14.3. Thereafter, the identification of line-specific conflicts and the establishment of potential solution alternatives for addressing the disruption detailed in the scenario (see section 8), is presented in subsection 14.4 and supported by the line-specific elemental conflict solution alternatives detailed in subsection 6.3. With the line-specific conflicts identified and the potential conflict solution alternatives established, an example of the development of PVSCS for specific trains following the approach detailed in section 9, is developed in subsection 14.5. Subsequently, in subsection 14.6 and utilizing the information ascertained at the line-specific level, an example of the assembly of PVSCS combinations through the implementation of the two metaheuristic algorithms introduced in section 10, is presented. Thereafter, in subsections 14.7 and 14.8, the respective implementation of the vehicle-specific CDCR process (according to section 11) and the assessment module (according to section 12) is exemplified on portions of PVSCS combinations. Finally, the adjustment of conflict-free PVSCS combinations (according to section 13) towards the selection of the system's solution is exemplified in subsection 14.9.

14.2. Scenario

As detailed in the introduction, the exemplary implementation and application of the dynamic DRP deployment system is based on an actual disrupted situation. Incorporating an actual disruption not only allows to illustrate the actual application of a disruption-management relying on a planned approach (i.e. relies on DRPs) assisted by a semi-automatic system but also exemplifies the implementation of each of the processes detailed in each of the system's modules.

This subsection describes the scenario, which includes specific information regarding the selected commuter railway network (i.e. implementation context to advance the example) and the relevant input variables required to handle the disruption, as discussed in section 5.

The scenario is a disruption that affected one of Germany's S-Bahn networks, and it is, therefore, aligned with the developmental field of the dynamic DRP deployment system (see subsection 3.3.2). Furthermore, the example also incorporates actual DRP operating concepts explicitly designed for the affected commuter railway network to address the disruption.

Furthermore, as discussed in the introduction (see subsection 14.1), the disrupted scenario has been selected since it portrays the network's most vulnerable section, therefore, affecting the broadest possible range of train services and infrastructural elements. The disruption, affecting the trunk line of the chosen S-Bahn network, closest to the city's central station, features a complete blockage of the selected section.

Overall, this subsection details a concrete example of the input variables discussed in section 5. Subsection 14.2.1 introduces the selected commuter railway network and the disruption as the foundation of the implementation example. Later, subsection 14.2.2 provides in-depth detail regarding the chosen DRP operating program, namely, the DRP relevant infrastructural elements and changes in the operating program introduced by the DRP operating concept.

14.2.1. Commuter Railway Network and the Disruption Information

While the dynamic DRP implementation system is structured for general validity and applicable to any commuter railway network, the S-Bahn network servicing the city of Frankfurt am Main, and the surrounding metropolitan area has been selected as the implementation environment due to the availability of information.

Commuter Railway Network

The chosen commuter railway network is known as the S-Bahn "Rhein-Main", as it covers the metropolitan area around the confluence of the Rhein and Main rivers (see figure 14.1). While the city of Frankfurt am Main is where the core of the commuter railway network is found (figure 14.1), the network stretches across multiple cities (e.g. Wiesbaden, Darmstadt, Hanau, etc.).

As of May 2019, the network is constituted by (DB AG, n.d.b):

- Nine lines
- 110 stations
- 205 vehicles
- A network length of approximately 300 kilometres
- 1034 scheduled train services per workday
- Servicing 540.000 passengers per workday

As depicted in figure 14.1, all nine lines of the network merge around the Frankfurt am Main city center and are routed through a tunnel that traverses the city. This area constitutes the network's trunk line (see figure 14.1). The city tunnel starts in the West at the station "Frankfurt Hbf" or Frankfurt's central station and runs Eastward up to the station "Lokalbahnhof".

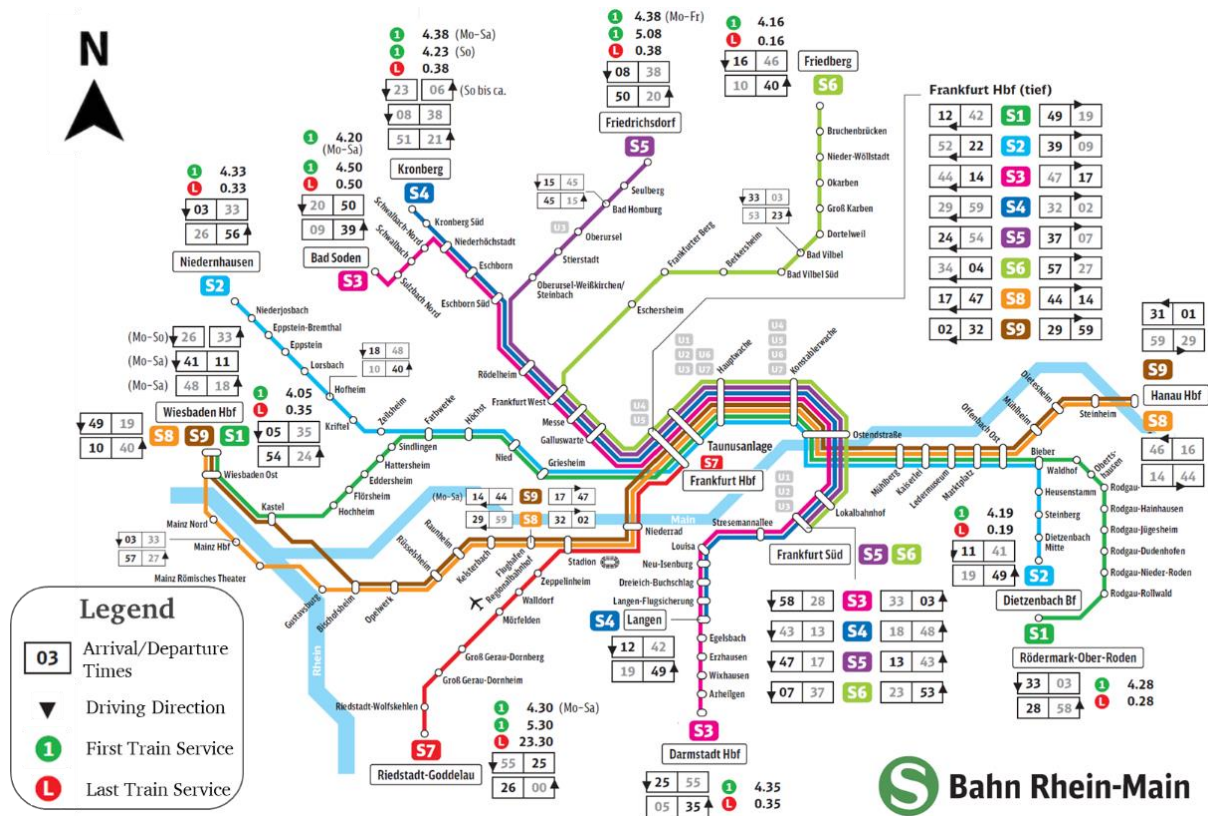

Figure 14.1 Network of the S-Bahn Rhein-Main (DB Regio AG 2016, modified by author)

In general, according to the schedule, every line in the network runs with a service interval of 30 minutes. However, this value fluctuates for some lines throughout the day to match passenger demand. For example, the service interval of lines such as S5 and S6 are reduced to 15 minutes during the peak hours by including service interval reinforcements (see subsection 3.6.2), or as in the case of line S7, modified by one hour in off-peak hours (i.e. SVZ). Ultimately, the network has three sets of corresponding lines: lines S3 and S4; lines S5 and S6; lines S8 and S9.

Disruption Information

The data to reconstruct the details of the actual disruption has been collected from archived information provided by the transport operator in charge of the chosen commuter railway network (i.e. DB Regio). The data was provided in the form of an incident report and a space-time traffic diagram of the trunk line displaying the handling of the disruption (see Figure 14.2).

The disruption took place on a Thursday in the spring of 2017, at 11:55 am in the station “Taunusanlage” near the city center of Frankfurt am Main (DB Regio AG 2017). The station is located within the core area in the city tunnel, which forms part of the trunk line (see figures 3.2 and 14.1).

The cause of the disruption was registered as a “personal accident” (see also figure 1.1), which induced a complete blockage of the section, making the station unreachable for any circulating train services (DB Regio AG 2017). As a result, two train services were directly affected by the disruption. Train service S35534, which provides service to line S5 with driving direction towards end station Friedrichsdorf, was directly involved in the incident (DB Regio AG 2017). Train service S35831, which provides service to line S8 with driving direction towards Hanau central station, was indirectly affected by the incident not able to continue driving due to the deployment of emergency rescue services in the station (DB Regio 2017).

The provided traffic diagram depicted in figure 14.2 demonstrates the extent of the disruption. The traffic diagram depicts time on the X-axis and space on the Y-axis. The traffic diagram covers the S-Bahn network between the stations Frankfurt-Rödelheim and Frankfurt Süd from 11:30 am to 2:30 pm (compare figure 14.1 and figure 14.2). Every coloured line represents a train service with a train number respective to its arrival time at the controlled region (i.e. Frankfurt-Rödelheim and Frankfurt Süd).

Every listed input variable can be ascertained (according to subsection 5.4) by categorizing the information provided by the operator.

The incident report indicates that the investigation phase (see figure 2.5 – subsection 2.3.2) had a duration of 4 minutes, after which the disruption program “G2” was declared at 11:59 am (DB Regio AG 2017). The exact time when the chosen DRP is declared is considered the system’s deployment time in the dynamic DRP deployment system. Moreover, based on the establishment of the temporal categories in subsection 4.4.2, the time interval between 9:00 am, and 17:00 pm falls within the “NVZ” category, between two peak hours. As a result, the system’s deployment time is recognized as: $t_{0,NVZ} = 11:59$.

The incident report also indicates the expected length of the disruption, which, in this case, was 2 hours (DB Regio AG 2017). Therefore, the expected disruption length can be recognized as: $t_{EDL} = 120 \text{ min}$.

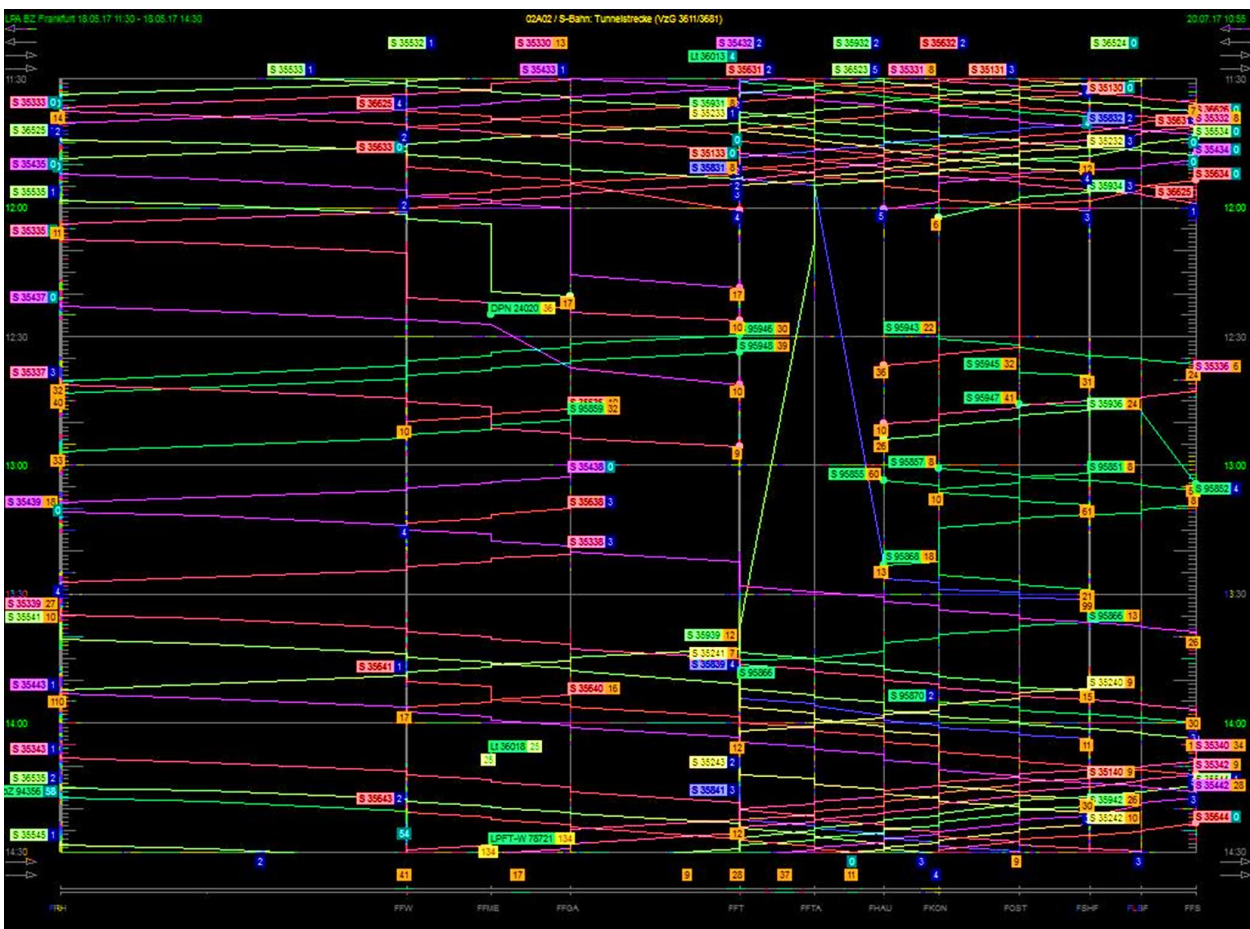

Figure 14.2 Traffic diagram depicting the handling of a disruption with a total blockage in the tunnel area of the S-Bahn Rhein-Main network (DB Regio AG 2017)

Regarding the infrastructural situation after the occurrence of the disruption (see subsection 5.4.1), the location of the disruption is in the network's trunk line at the station "Taunusanlage". Second, the disruption has left the station entirely inaccessible; thus, the platform tracks in both driving directions cannot be reached. Third, two LtTTS are recognized on each side of the disruption. For trains driving from West to East (see figure 14.1), the LtTTS can be recognized as the underground station in Frankfurt's central train station (Frankfurt Hbf – Tief). For trains driving from East to West, the LtTTS is Hauptwache. Fourth, following the standard approach to establishing the critical area, as discussed in subsection 3.7.2 (i.e. covering the last two technically feasible turning stations on each side), the resulting critical area and the respective sides in the disruption divided network are depicted in figure 14.3.

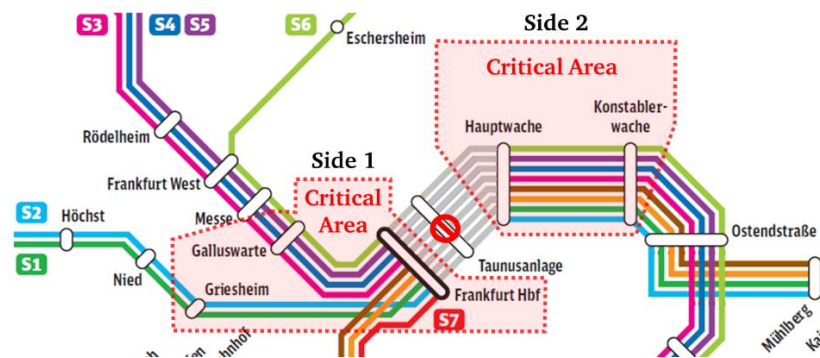

Figure 14.3 Affected section and critical area (Kremer and Rink 2016, modified by author)

Ultimately in the case of the implementing example, the information about the trains detailed in subsection 5.4.2 is derived from the traffic diagram as depicted by figure 14.2. However, since the diagram only covers the area open to the public between Frankfurt-Rödelheim and Frankfurt Süd, the position of all remaining trains is considered vis-à-vis their schedules (respective to the year 2017 - during a weekday), at a time: $t_{0,NVZ} = 11:59$.

All in all, the data regarding the disrupted information utilized to advance this example amounts to the traffic diagram and incidence report presented in figure 14.2. While the data is limited in extent as it does not provide information from all the trains circulating in the network, the integration of the existing schedules can help to complement this information and utilize it to implement the dynamic DRP deployment system.

14.2.2. Chosen DRP Operating Concept

After choosing the DRP according to guidelines described in subsection 14.2.1, the relevant DRP infrastructural elements and changes introduced to the operations of each of the lines can be recognized.

A graphic representation of the DRP operating concept contained within the chosen DRP specifications is depicted in figure 14.4.

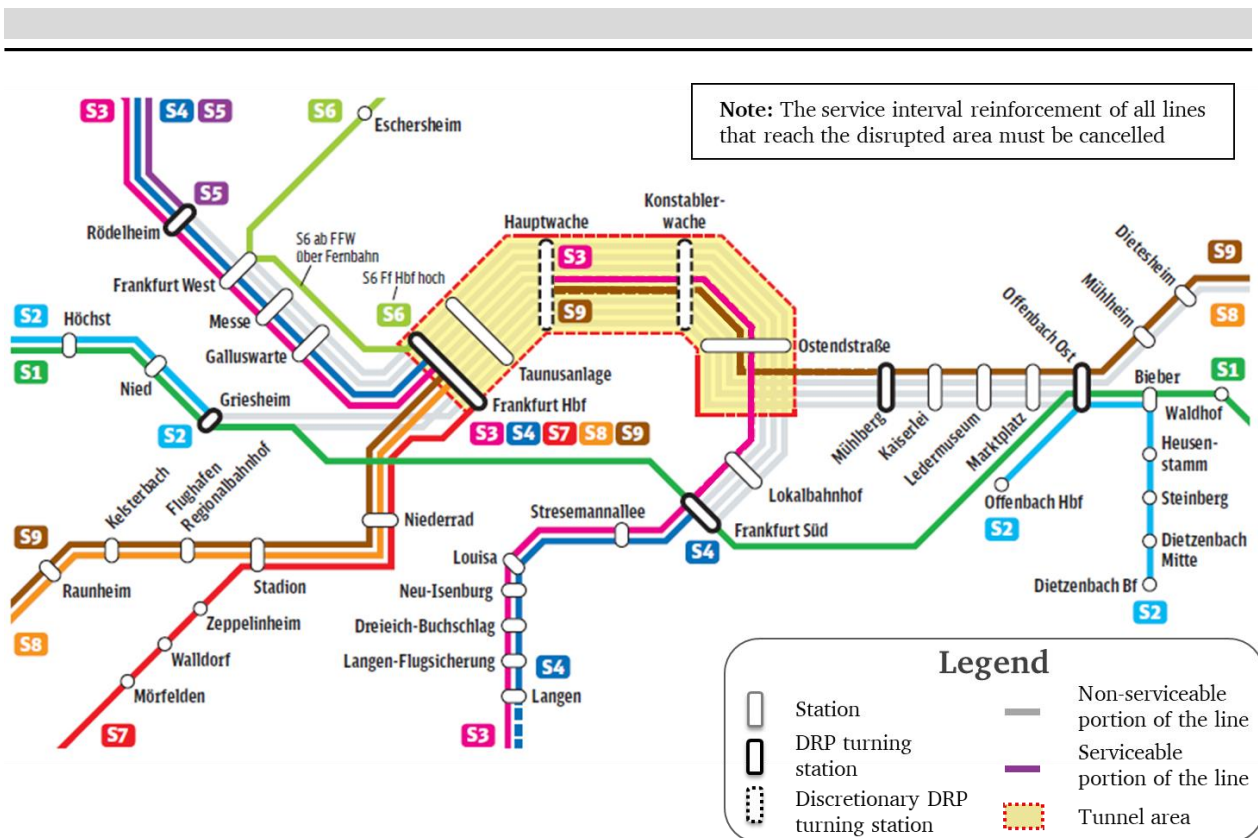

Figure 14.4 Example of a DRP operating concept (Kremer and Rink 2016, modified by author)

Figure 14.4 provides visual support for dispatchers as it summarizes the line-specific measures to be implemented in the network. Of the nine lines, which constitute the investigated commuter railway network, all but line S7 are affected by the disruption.

The specific measures introduced by the DRP operating concept of the chosen “DRP-G2” are summarized in table 14.1. Most of the measures detailed in table 14.1 are shown in figure 14.4.

In the first two columns, table 14.1 identifies the specific line and direction of travel for each detailed measure. The third column in the table details the DRP turning stations and the direction of travel for every line within the DRP operating concept. Two of the listed DRP turning stations do not form part of the commuter railway network under investigation, namely, Offenbach Hbf appointed to line S2 and Frankfurt Hbf (Hoch) appointed to line S6 (see figure 14.1). The fourth column describes the deviation points, where the line must be deviated away from its original route. Here, it can be pointed out that line S1 is the only line being completely deviated to deal with the disrupted section. Finally, the last column provides further details for some measures, describing the routes that must be utilized to access specific platform tracks in their DRP turning stations.

Table 14.1 Line-Specific measures contained in the chosen DRP operating concept (Kremer and Rink 2016 – see Figure 14.4)

Line	Driving Direction	Separate in:	Route	Observations
S1	Rödermark-Ober-Roden		Deviated from/to Griesheim to/from Offenbach Ost	Additional stop in Frankfurt Süd
	Wiesbaden Hbf*			
S2	Dietzenbach	Griesheim	Deviated from/to Offenbach Ost to/from Offenbach Hbf	
	Niedernhausen	Offenbach Hbf		

Line	Driving Direction	Separate in:	Route	Observations
S3	Darmstadt Hbf	Frankfurt Hbf (Tief)**		Drive-in Frankfurt Hbf (Tief) to platform track 101; Exit utilizing track in the opposite direction
	Bad Soden	Hauptwache		
S4	Langen	Frankfurt Hbf (Tief)		Drive-in Frankfurt Hbf (Tief) to platform track 104 utilizing the track in the opposite direction. The route is changed utilizing the entrance switch to the station Galluswarte (see figure 14.9).
	Kronberg	Frankfurt Süd		
S5	Frankfurt Süd	Rödelheim		
	Friedrichsdorf	Rödelheim		
S6	Frankfurt Süd	Frankfurt Hbf (Hoch)***	Deviated from/to Frankfurt West	Cancel stops at: Messe and Galluswarte
	Friedberg	Frankfurt Hbf (Hoch)	to/from Frankfurt Hbf (Hoch)	
S8	Offenbach Ost/ Hanau Main Station	Frankfurt Hbf (Tief)		Drive-in Frankfurt Hbf (Tief) to platform track 103
	Wiesbaden Hbf	Frankfurt Hbf (Tief)		
S7	Line S7 in both directions continues with its scheduled operations without any change			
S9	Offenbach Ost/ Hanau Hbf	Frankfurt Hbf (Tief)		Drive-in Frankfurt Hbf (Tief) to platform track 102
	Wiesbaden Hbf	Hauptwache		

* Hbf: Abbreviation of the German word “Hauptbahnhof”, which translates to: central train station.

**Tief: German word, which translates to: deep. It is utilized to refer to the underground portion of a larger railway station.

***Hoch: German word, which translates to: high. It is utilized to refer to the aboveground portion of a larger railway station.

Finally, by categorizing the information provided by the operator according to subsection 5.3, every listed input variable can be ascertained.

First, by contrasting the information presented in table 14.1 against its graphic representation depicted by figure 14.4, all the relevant DRP infrastructural elements (i.e. DRP turning stations, deviation points and portions of the original line’s route which are cancelled) can be identified for every affected line (see subsection 5.3.1). Second, with the information provided in subsection 14.2.1 and supported by the measures detailed in both table 14.1 and figure 14.4, the DRP recognizes two different sides in the affected network, with the sole exception of line S1, which is deviated to overcome the disruption.

Finally, the changes in the operating programs of the lines can also be ascertained (see subsection 5.3.2). Figure 14.4 reveals that all train services working as service interval reinforcement must be cancelled, while the necessary changes in routes, platform tracks, and stopping stations are detailed in the last column of table 14.1.

All in all, the data regarding the DRP operating concept utilized to advance this example (see figure 14.4 and table 14.1) amounts to a very detailed representation of the actual DRP operating concept utilized to address the disruption introduced in the previous subtitle. By means of the information detailed in this subtitle, the actual capabilities of the system can be advanced to the full extent foreseen by the specific objectives discussed in subsection 3.2.2.

14.3. DRP Set-up

With details of the scenario detailed, including the chosen DRP, the dynamic DRP deployment system can now be implemented. As displayed in figure 3.1, the first module in line with the implementation of the system is constituted by the enhanced DRP set-up detailed in section 7. This subsection expands upon the details of the scenario introduced in subsection 14.2 by implementing the enhanced DRP set-up module, as discussed throughout section 7.

Overall, the enhanced DRP set-up process identifies first and second-order infrastructural elements and clusters all trains circulating in the network into five categories.

Subsection 14.3.1 describes the identification of the infrastructural elements based on the process discussed in subsection 7.3.1. and subsection 14.3.2 explains the implementation of the enhanced clustering process detailed subsection 7.3.2.

14.3.1. Identification and Flagging of Infrastructural Elements

The identification and flagging of infrastructural elements enables the exploration of alternatives beyond the three elements already recognized as DRP relevant infrastructural elements, to enhance the handling of trains during a disruption. As detailed in subsection 7.3.1, the identification and flagging process distinguishes between first-order (i.e. DRP relevant infrastructural elements) and second-order elements (i.e. infrastructural elements that provide further handling alternatives), both of which are exemplified in this subsection.

Since first-order elements are recognized as DRP relevant infrastructural elements, their identification does not require further inquiry as they are already detailed in subsection 14.2.2. The infrastructural elements listed in table 14.1 (columns two and three) constitute every affected lines' first-order elements vis-à-vis the chosen DRP operating concept.

On the other hand, second-order infrastructural elements must still be identified. As detailed in subsection 7.3.1, second-order elements can be classified either as "off-line" or "on-line". For the purpose of this example, second-order elements are identified "on-line" by observing the five specific infrastructural features discussed in 7.3.1.

Since the process must be conducted identically for every affected line, the line chosen for this example is irrelevant. Here, line S5 is used to identify and flag the second-order infrastructural elements considering the line's scheduled route and chosen DRP operating concept. During the disruption, the chosen DRP foresees the cancellation of the operations of line S5 on side 2 of the divided network (see figures 14.3 and 14.4), for the purposes of the example the exploration of second-order elements is focused on side 1.

The identification and flagging process detailed in subsection 7.3.1 provides a list of five features to support the exploration of second-order elements. Due to limited access to immediate information regarding the features of specific infrastructure elements, the exploration is mostly conducted by observing one particular feature, namely, the ability to link to the core area. As displayed in figure 3.2, the core area of the investigated network includes all stations from Rödelheim to Frankfurt Süd. Therefore, the portion of the core relevant to line S5 on side 1 (i.e. between Rödelheim and Frankfurt Hbf - Tief) is investigated in further detail.

Figure 14.5 provides an overview of all infrastructural elements with the potential of being flagged as second-order elements for line S5 on side 1. The figure incorporates the portion of the DRP

operating concept relevant to the investigated side (see figure 14.4) and pays particular attention to the existence of potential deviation points and relevant nodes that might be accessed along the investigated line's route.

The DRP operating concept for line S5 appoints station Rödelheim (i.e. Station E, in figure 14.5) as the line's DRP turning station and is thus considered a first-order turning station. Beyond station E, every other technically feasible turning station may be considered as a second-order turning station if it can support the removal, a train clustered in the line's Yellow category away from the critical area.

Furthermore, since the line's DRP operating concept does not foresee any deviation along the line's route, figure 14.5 does not depict any first-order deviation point. However, several second-order deviation points have been identified. The flagging of these deviation points dramatically increases the number of handling alternatives for the trains on this line. The most notorious example would be the ability to deviate an S5 train to a turning station outside the commuter railway network (i.e. station Z – see figure 14.5).

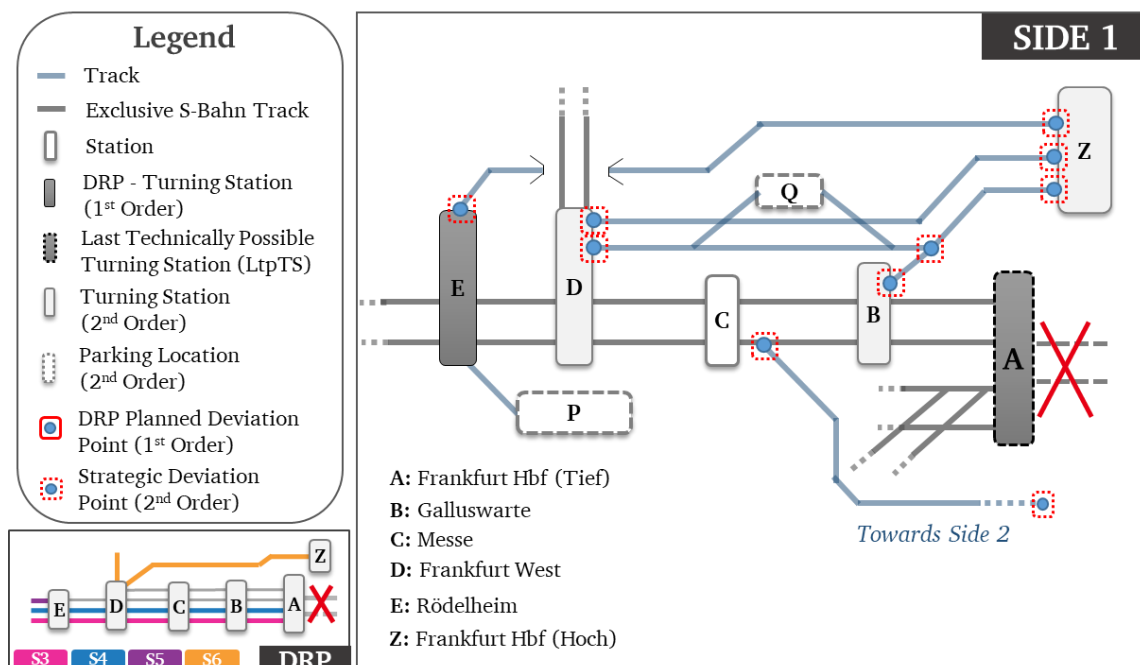

Figure 14.5 Example for the identification and flagging of second-order elements (by author)

Additionally, potential parking locations have also been identified along the link between stations D and Z as well as accessible through station E. As discussed in section 8, if line S5 has a surplus of vehicles, the immediate availability of parking locations is of particular relevance.

In figure 14.5, a second-order deviation point that may be utilized to overcome the disrupted section has also been identified beyond station C. While the operating concept of line S5 does not support the line's operations on side 2 during the disruption, the deviation point can still be utilized to potentially transfer trains from the opposite side if there is a lack of trains.

14.3.2. Clustering of Trains

Clustering trains into five categories permit to immediately recognize certain characteristics for each train, from the moment the DRP has been declared (i.e. dispatching handling possibilities

within the DRP operating concept). The clustering process recognizes five categories, namely: Green, Green+, Yellow, Red and Red+. This subsection exemplifies the implementation of the clustering process detailed in figure 7.1 within the scenario introduced in subsection 14.2.2.

In order to provide a detailed description of the clustering process, the example is extended to cover the clustering of at least one train in each of the five categories. Since the process is the same regardless of the train line, the line chosen for the example is irrelevant. Therefore, trains of the same line S5, as in subsection 14.3.1, are taken into consideration for implementing the clustering process.

As discussed in subsection 7.3.2, the clustering process relies upon a clear understanding of the actual position of the trains in the network at $t_{0,TD}$ and the line's DRP relevant infrastructural elements (i.e. first-order elements). While the first-order and second-order elements have already been identified in subsection 14.3.1, the position of the trains in the network is derived either from the traffic diagram detailed in figure 14.2 or according to their schedules (respective to the year 2017) and the system's deployment time (see subsection 14.2.1).

Table 14.2 provides the position of every train circulating in the network for all train servicing line S5. As detailed above the position is either taken from the traffic diagram displayed in figure 14.2 or the schedule according to the system's deployment time $t_{0,NVZ} = 11:59$.

Table 14.2 Actual position of all trains of line S5 (by author)

Train Number	Driving Direction	Actual Location	Side
S36527	Frankfurt Süd	Bad Homburg**	1
S35537	Frankfurt Süd	Friedrichsdorf**	1
S35535	Frankfurt Süd	Frankfurt West*	1
S36525	Frankfurt Süd	Frankfurt Hbf (Tief)*	1
S35533	Frankfurt Süd	Frankfurt Süd*	2
S35534	Friedrichsdorf	Taunusanlage*	2
S36524	Bad Homburg	Oberursel**	1

* Actual location derived from traffic diagram at 11:59 am – see figure 14.2

**Actual location derived from the schedule at 11:59 am (respective to the year 2017)

In the table, the first column details the train number, which is either derived from the traffic diagram (see figure 14.2) or extrapolated from the diagram to the rest of the trains according to the schedule. The second column explains the driving direction of the train by providing its end station. The third column indicates the actual location of each of the trains from line S5 at $t_{0,NVZ}$. The last column identifies the side respective to their location, as depicted in figure 14.3.

With an understanding of the location of each of the trains, they can be clustered into categories vis-à-vis the DRP relevant infrastructural elements detailed in table 14.2. The clustering process is performed as detailed in figure 7.1. While the process is applied to each train individually, in this example, all trains detailed in table 14.2 are handled simultaneously.

Red Trains

The first category to be recognized in the clustering process is the Red and Red+ categories by considering if the trains have been affected by the disruption.

The incident report introduced in subsection 14.2.1 indicates that train service S35534 has been directly affected by the disruption, and it is not allowed to keep driving. Therefore it cannot reach its end station, so train service S35534 is clustered in the Red category of line S5: R_{5_2} .

Red+ Train

As detailed in subsection 7.3.2, Red+ trains have been affected by the disruption; however, they are able to continue driving towards their end station after its time-out concludes (see subsection figure 7.1). While none of the trains for line S5 (see table 14.2) fits such a description, the incident report detailed in subsection 14.2.1 explains that train service S35831 (i.e. line S8) has not been directly affected by the disruption. Due to the deployment of emergency services within the affected station, however, the train is momentarily not allowed to keep driving. Therefore, train service S35831 is clustered in the Red+ category of line S8: $R +_{8_1}$.

Yellow Train

As detailed in figure 7.1, once it has been established that a train has not been affected by the disruption, it is necessary to verify if its actual position (considering its driving direction) situates it beyond their line's DRP relevant infrastructural elements.

Consequently, all trains on side 1 of line S5 driving towards the disrupted section can be clustered in the Yellow category if their actual location lies beyond the line's DRP turning station (i.e. Rödelheim – see table 14.2). Since the actual location and driving direction of train service S35535 (i.e. Frankfurt West) and train service S36525 (i.e. Frankfurt Hbf - Tief) situates them beyond the station Rödelheim (see figure 14.2), they are clustered in the Yellow category of line S5 on side 1: Y_{5_1} .

Furthermore, considering that the DRP turning station for both driving directions of line S5 is identified as station Rödelheim (see figure 14.4), the operations for line S5 on side 2 must be cancelled. Therefore, all trains on side 2 can be immediately clustered in the Yellow category. Thus, train service S35533 is clustered in the Yellow category of line S5 for side 2: Y_{5_2} .

Green+ Train

As detailed in figure 7.1, the driving direction of all remaining trains yet to be included in a cluster must be determined to establish if they should be placed in the Green or Green+ category.

All trains on line S5, side 1, driving away from the disrupted section (i.e. with driving direction towards Friedrichsdorf or Bad Homburg) are clustered in the Green+ category. Due to its scheduled end station, train service S36524 can be introduced in the Green+ category of line S5 for side 1: $G +_{5_1}$.

Green Trains

Finally, all trains that have not been clustered thus far fall in the Green category. They are driving towards the disrupted section and have not reached the DRP relevant infrastructural element respective to their line.

Consequently, train service numbers S36527 and S35537 of line S5, on side 1, are both clustered in the Green category: G_{5_1} .

Summary

After implementing the enhanced train clustering process detailed in figure 7.1, all seven trains on line S5 across both sides of the disruption divided network have been successfully clustered into their respective train categories. The results of the clustering process are detailed in table 14.3.

Table 14.3 is a complement to table 14.2 and details in its last column, the train category for each of the investigated train services.

Table 14.3 Example for the clustering of train categories (by author)

Train Number	Driving Direction	Actual Location	Side	Train Cluster
S36527	Frankfurt Süd	Bad Homburg**	1	Green
S35537	Frankfurt Süd	Friedrichsdorf**	1	Green
S35535	Frankfurt Süd	Frankfurt West*	1	Yellow
S36525	Frankfurt Süd	Frankfurt Hbf (Tief)*	1	Yellow
S35533	Frankfurt Süd	Frankfurt Süd*	2	Yellow
S35534	Friedrichsdorf	Taunusanlage*	2	Red
S36524	Bad Homburg	Oberursel**	1	Green+

* Actual location derived from traffic diagram at 11:59 am – see figure 14.2

**Actual location derived from the schedule at 11:59 am (respective to the year 2017)

14.4. Line-Specific Conflict Identification and Establishment of Potential Solution Alternatives

As outlined in figure 3.1, the next module in the system is the line-specific conflict identification and classification, which establishes potential line-specific conflict solution alternatives. Building on the flagged infrastructural elements and train categories established in the DRP set-up module (subsection 14.3), this section implements the processes contained within the line-specific conflict identification module, as detailed in figure 8.2.

Overall, the line-specific conflict identification and classification module is aimed at establishing a detailed conflict list for all lines and sides (if applicable). As discussed in subsection 8.3, the conflict list not only delivers information regarding the type of the line-specific conflicts identified across all affected lines (i.e. vehicle availability or reachability conflicts) but also allows to establish potential solution alternatives to resolve them.

Furthermore, as it was the case for the implementation of the DRP set-up module, the processes are performed systematically for every affected line. Therefore, the specific line chosen to implement the processes is irrelevant. Aligned with subsection 14.3, this subsection continues to extend the example for line S5, while providing an overview of all affected lines and specific cases (i.e. lines that are not divided into two different sides).

The following subsection 14.4.1 identifies vehicle availability conflicts based on the process discussed in subsection 8.4.2, and subsection 14.4.2 classifies the identified vehicle availability conflicts as per subsection 8.4.3. Thereafter, the example applies the reachability conflicts identification process described in subsection 14.4.3 and classifies these in subsection 14.4.4, according to subsection 8.4.5. Finally, subsection 14.4.5 offers an example of the sorting of line-specific conflict in a list.

14.4.1. Identification of Vehicle Availability Conflicts

The identification of vehicle availability conflicts is based on the comparison between the number of available trains n_{A,l_s} and the number of vehicles required n_{R,DRP,l_s} to run a line's DRP operating concept per line and side (if applicable). This subsection provides with an example that puts in practice the identification of vehicle availability conflicts outlined in subsection 8.4.2.

The number of available vehicles can be ascertained immediately by reviewing the number of trains in the different clusters per line and side (if applicable). In the case of line S5, table 14.3 provides an overview of all trains circulating in the network clustered within the different train categories across both sides of the disruption divided network. By introducing the number of trains of line S5 for each respective category and for each individual side in equation 8.1, the number of available trains n_{A,l_s} can be ascertained as follows:

$$n_{A,5_1} = 2 + 1 + 2 = 5$$

$$n_{A,5_2} = 1$$

It must be noted that in case a line is deviated to overcome the disruption situation, as is the case of line S1 in the scenario (see figure 14.4), or during a partial blockage for lines which are not divided by the DRP operating concept, the number of available vehicles is ascertained by considering all vehicles that are not clustered in either Red or Red + categories without considering sides.

Furthermore, subsection 8.4.2 explains that to obtain the number of vehicles required to run the DRP, the DRP service interval t_{SI,DRP,l_s} and the DRP cycle time $t_{C_{DRP,l_s}}$ for the respective line on each of its sides (if applicable) must be established.

Initially the DRP service interval t_{SI,DRP,l_s} is established by considering the line's current service interval, including any potential cancellation of train services as established by the DRP operating concept. In the case of the DRP utilized in this scenario (see figure 14.4), all service interval reinforcements across all lines that reach the disrupted section should be cancelled. Since line S5 on side 1 has Rödelheim as its DRP turning station, the line does not reach the critical area (see figure 14.4). Consequently, all originally scheduled train services of line 5 on, side 1, must be supported. On the contrary, the DRP operating concept of line S3 appoints the LtFTS on both sides of the disruption as the line's DRP turning stations (see figure 14.3). Therefore, all train services foreseen as service interval reinforcement for line S3 should be cancelled on both sides of the disruption.

The schedule of line S5 has a baseline service interval of 30 minutes. Nonetheless, the line is also appointed with train services as service interval reinforcements between 6:00 am and 19:00 pm. Due to the existence of the service interval reinforcements during the considered disruption (see subsection 14.2.2), the service interval of the line S5 is reduced to 15 minutes. Since the DRP operating concept does not foresee the cancellation of any train services, the DRP service interval for line 5 on side 1 during the disruption (i.e. from the implementation of the system plus the expected disruption length) is equal to: $t_{SI,DRP,l_s} = 15 \text{ min}$.

Furthermore, the DRP cycle time $t_{C_{DRP,l_s}}$ is ascertained for every line and side (if applicable) by considering the changes introduced by the DRP and the existence of different cycle variants. In the case of line S5 on side 1, since the train services schedule as service interval reinforcement begin/end from/at station Bad Homburg instead of Friedrichsdorf, the line's cycle time must support the existence of different cycle variants. Therefore, information from the schedule, namely, the journey times and the turning times in the end and DRP turning stations detailed in subsection 8.4.2, permit to ascertain the cycle time for each variant as generalized in equation 8.4.

- For cycle variant 1 between Friedrichsdorf and Rödelheim:

$$t_{C_{DRP,5,1}} = 19 \text{ min} + 18 \text{ min} + 17 \text{ min} + 6 \text{ min} = 60 \text{ min}$$

- For cycle variant 2 between Bad Homburg and Rödelheim:

$$t_{C_{DRP,5,2}} = 12 \text{ min} + 27 \text{ min} + 15 \text{ min} + 6 \text{ min} = 60 \text{ min}$$

The number of required vehicles n_{R,DRP,l_s} per line and side (if applicable) is determined by allowing trains to switch between the different cycle variants. The number of vehicles required for line 5 on side 1 is determined through equation 8.6.

$$n_{R,DRP,5_1} = \left\lceil \sum_{\psi=1}^2 \frac{t_{C_{DRP,5_s,\psi}}}{t_{SI,DRP,5_s,\psi}} \right\rceil = \left\lceil \frac{60 \text{ min}}{30 \text{ min}} + \frac{60 \text{ min}}{30 \text{ min}} \right\rceil = \lceil 4 \rceil = 4$$

As the DRP of line S5 foresees no operations during the disruption on side 2, the number of vehicles required is zero (i.e. $n_{R,DRP,5_2} = 0$).

Finally, the number of conflicting trains n_{C,l_s} for line S5 on each side can be ascertained through equation 8.8.

- For line S5 on side 1:

$$n_{C,5_1} = 5 - 4 = +1$$

- For line S5 on side 2:

$$n_{C,5_2} = 1 - 0 = +1$$

As a result, line S5 has an overall surplus (i.e. +) of two trains circulating in the network: one train on side 1 of the disruption and one train on side 2.

The exploration conducted above for line S5 is extended to all the lines affected by the disruption. Table 14.4 provides an overview of all vehicle availability for every line with enough detail to distinguish the number of available, required and conflicting trains per line and side (if applicable).

Table 14.4 Example of vehicle availability conflicts (by author)

Deviated Lines		Divided Lines								Source or Calculation	
Line	S1	Line	S2	S3	S4	S5	S6	S8	S9		
n_{A,l_1}	7	Side 1	n_{A,l_1}	3	2	2	5	6	4	4	Eqq. 8.1*
			n_{R,DRP,l_1}	3	3	3	4	3	4	4	Eqq. 8.6**
n_{R,DRP,l_1}	7	Side 2	n_{C,l_1}	0	-1	-1	+1	+3	0	0	Eqq. 8.8
			n_{A,l_2}	2	3	2	1	1	1	3	Eqq. 8.1*
n_{C,l_1}	0	Side 2	n_{R,DRP,l_2}	2	3	2	0	0	0	3	Eqq. 8.6*
			n_{C,l_2}	0	0	0	+1	+1	+1	0	Eqq. 8.8

* Actual train locations derived from the traffic diagram (figure 14.2) and the original schedules

** Journey times and cycle variants are derived from the schedule (respective to the year 2017), and according to the chosen DRP operating concepts of every line.

14.4.2. Classification of Vehicle Availability Conflicts

The classification of vehicle availability conflicts is conducted for every line and side (if applicable) considering the nature of the identified conflicts (i.e. lack or surplus of vehicles). The classification is conducted by observing the classification schemes introduced in subsection 8.4.3.

As detailed in subsection 8.4.3, for the classification of vehicle availability conflicts, it is suggested to start with any affected line where one of its sides has a lack of vehicles (also considering the existence of corresponding lines). If the line has one or more identified corresponding lines with a lack of vehicles, it is further recommended to start the classification process with the line and side (if applicable) that lacks the higher amount of vehicles (see subsection 8.4.3).

As in previous subsections, the vehicle availability conflicts for line S5 are to be discussed in detail throughout this subsection. While the example focuses on line S5, it also considers the vehicle availability of line S6, as they are corresponding lines.

Since neither line S5 nor line S6 (i.e. the corresponding line – see subsection 14.2) have a lack of trains on either of their sides, the compensation through an exchange of trains between corresponding lines or a transfer of trains between sides across the disruption divided network is not feasible. As a result, both lines S5 and S6 would have their vehicle availability conflicts classified between classification numbers 37 and 41, as detailed in table 8.2.

Furthermore, the commuter railway network investigated in this scenario does not foresee the coupling or decoupling of any of its train services within its original schedule. This suggests that a compensation through a coupling of train units is not a desired alternative, as discussed in subsection 8.4.3. Additionally, it is not possible to conduct an exploration of the situation in every parking location for each of the affected lines since this information has not been made available. As a result, lines S5 and S6 across both of their sides can be classified as having a vehicle availability conflict of either class 37, 39 or 41, namely, VA- l_S -S-S [PT], VA- l_S -S-S [PT/PT_U], VA- l_S -S-S [PT_U] (see table 8.2).

From the three potential classes that have been identified for both lines, the potential line-specific measures can be ascertained. In overall, both lines require to remove and park their trains in either conventional (i.e. PT) or unconventional parking locations (PT_U). However, this depends on the parking availability throughout the different parking locations accessible to the trains of both lines.

14.4.3. Identification of Reachability Conflicts

Reachability conflicts are identified based on all train services that started before the implementation of the system and cannot reach their end station due to the existence of a complete blockage or due to the line's DRP operating concept. This subsection provides an example of the identification of reachability conflicts, as outlined in subsection 8.4.4.

Initially, the train clusters established in the DRP set-up module for the affected lines are also useful to identify train services that have induced a reachability conflict. As detailed in subsection 8.4.4, reachability conflicts are identified in correspondence to the magnitude of the disruption (see subsection 3.6.2) and the chosen DRP operating program of the respective line.

In case of the example handled so far, with the sole exception of train services clustered in the Green+ category, all remaining train services on line S5 have the potential to generate a reachability conflict on the opposite side of the line. The respective sets of reachability conflicts rc_{l_S} is established as follows:

- Aligned with the train services detailed in table 14.3, the set of reachability conflicts for line S5 on side 1 includes:

$$rc_{5_1} \{\mathbf{S35534}\}$$

- Aligned with the train services detailed in table 14.3, the set of reachability conflicts for line S5 on side 2 includes:

$$rc_{5_2} \{S36527, S35537, S35535, S36525\}$$

As depicted in figure 8.6 (see subsection 8.4.4), since the train services included in each set cannot reach their originally scheduled end stations, they induce a reachability conflict on the opposite side of the disruption divided network.

Nonetheless, there are two other potential cases that must be considered:

- The DRP operating concept of a line foresees the deviation of the line to overcome the disruption, as it is the case of line S1 (see figure 14.4). In this case, only train services clustered in the Yellow, Red, and Red+ categories that cannot reach their end station may induce a reachability conflict.
- During a partial blockage and if the DRP operating concept divides the line into two sides, reachability conflicts are identified following the same principles, as in the case of line S5.

14.4.4. Classification of Reachability Conflicts

Reachability conflicts are classified by observing the classification schemes introduced in subsection 8.4.5 and, as with vehicle availability conflicts, are specific to each line and side (if applicable). As detailed in subsection 8.4.4, the classification of line-specific conflicts is dependent on the nature of already classified vehicle availability conflicts (i.e. lack or surplus).

The classification of reachability conflicts begins by appraising the technical feasibility of resolving the identified conflicts through the early turning (or turning) of available trains at specified locations. Then, it is determined whether the train service identified as generating a reachability conflict induces a service conflict if partially or fully cancelled.

Appraisal of the Technically Feasible Turning Stations for the Reachability Conflicts in rc_{l_s}

The first step in the classification appraises whether reachability conflicts can be resolved by the early turning (or turning) of trains throughout at different technically feasible turning stations and which result in train services that can still be within the on-time threshold. In the case of line S5, the appraisal of the turning stations takes place individually on both sides of the disruption by investigating a potential early turn (turn) of available train services through the turn residual principle. Available train services refer to all train services clustered in the Green and Yellow categories that may be utilized to solve the identified reachability conflict (see subsection 8.4.5).

The turn residual is computed through equation 8.20. The values to be introduced in equation 8.20 are ascertained from the schedule (respective to 2017), the traffic diagram and the scenario information. The initial delay $t_{v_{T_{l_s}}}$ is established by ascertaining the position of an investigated train in the traffic diagram at a time equal to the system's implementation time (i.e. 11:59) and comparing it with its scheduled position. Furthermore, the minimum turning time acquires the value recommended in subsection 3.6.2 (i.e. 6 minutes).

As is summarized in table 14.3, there are four available train services clustered in the Green and Yellow categories of line S5 on side 1 of the network. The investigation starts with the train the closest to the disrupted section, namely, train service S36525 (Yellow). Since this train is already located at the LtTTS (i.e. Frankfurt Hbf – Tief), the turn residual (TR) respective to a turn of the

investigated train service (S36525) to each conflicting train service contained in the set rc_{5_1} can only be conducted at this station.

Using equation 8.20, it can be ascertained that a potential turn of train service S36525 to the only conflicting train service in the set rc_{5_1} {S35534} at Frankfurt Hbf (Tief) would potentially induce a negative turn such that this would result in train service S35534 departing from the turning station with a delay of approximately 11 minutes.

$$TR_{S36525_{5_1}-S35534_{5_1}}^{FFM\ Hbf\ (Tief)} = 11:54 - 11:52 - 7\ min - 6\ min = -11\ min$$

The same principle is conducted for every train service throughout all technically feasible turning stations they are able to access (see figure 14.5). However, subsection 8.4.5 introduces certain restrictions when selecting the turning stations that must or can be investigated. For example, only turns at DRP turning stations must be investigated for trains clustered in the Green category.

Later, as detailed in subsection 8.4.5, the turn residuals (calculated through equation 8.20) for every available train service towards a specific conflicting train service in the set rc_{5_1} at the investigated technically feasible turning stations are summarized in a matrix, as per equation 8.21.

$$TR_{S35534_{5_1}} = \begin{bmatrix} TR_{S36525_{5_1}-S35534_{5_1}}^{FFM\ Hbf\ (Tief)} & 10000 & 10000 & 10000 \\ TR_{S35535_{5_1}-S35534_{5_1}}^{FFM\ Hbf\ (Tief)} & TR_{S35535_{5_1}-S35534_{5_1}}^{Galluswarte} & TR_{S35535_{5_1}-S35534_{5_1}}^{Frankfurt\ West} & 10000 \\ 10000 & 10000 & 10000 & TR_{S35537_{5_1}-S35534_{5_1}}^{Rödelheim} \\ 10000 & 10000 & 10000 & TR_{S36527_{5_1}-S35534_{5_1}}^{Rödelheim} \end{bmatrix} = \begin{bmatrix} -11min & 10000 & 10000 & 10000 \\ -20min & -17min & -13min & 10000 \\ 10000 & 10000 & 10000 & -39min \\ 10000 & 10000 & 10000 & -24min \end{bmatrix}$$

As discussed in subsection 8.4.5, large positive integers are introduced in the matrix at the technically feasible turning stations that a specific train service was not able to access or reach. For example, train service S35535 (Yellow) has as its actual location the station Frankfurt West; therefore, in the column respective to the station Rödelheim a large integer is introduced instead.

The appraisal of the potential turning stations concludes by verifying if there are any turn residuals in the matrix that foresees the potential generation of a delayed train within the on-time threshold (i.e. $t_{Ot} = -6min$, see subsection 3.6.2). Train services within the on-time threshold are ascertained through equation 8.22. It is possible to ascertain that there are no train services within the on-time threshold (i.e. delay between 0 minutes and 6 minutes) from the turn residual values displayed in the matrix.

The approach explained above must also be conducted for side 2 of line S5 for all the conflicting train services in the set rc_{5_2} , and, ultimately, across all lines as well.

Evaluation of the Cancellation of a Conflicting Train Service in rc_{l_s}

The classification process also establishes whether the cancellation of a conflicting train service (i.e. a train service identified as a reachability conflict) in the respective sets rc_{l_s} may potentially induce a service conflict.

The verification begins by ascertaining the generated service interval $t_{SI_{Trc_{l_5}}^{S_a}}$, as accurately as possible by means of equation 8.23. As discussed in subsection 8.4.5, to ascertain the generated service interval, it is necessary to identify the previous and subsequent trains services that reach an investigated station. These train service must have the same end station as the cancelled train service. However, with the information available at this stage of the implementation of the system, it is difficult to ascertain with precision the previous and subsequent train services.

In the specific case of line S5 for side 1, the set of reachability conflicts rc_{5_1} {S35534} is constituted by one sole service. The conflicting train service S35534 has Friedrichsdorf as its end station (see table 14.3). As depicted in figure 14.4, only line S5 reaches the station of Friedrichsdorf; thus, only trains from the same line may be considered to determine any previous or subsequent train service. Furthermore, since line S5 on side 1 has different cycle variants (see table 14.3) that terminate their service pre-emptively in station Bad Homburg, train services scheduled as service interval reinforcements cannot be considered as previous or subsequent train service.

As discussed in subsection 8.4.5, the previous and subsequent train services must be established on every train station affected by the cancellation of the conflicting train service. For example, only the first station affected by the cancellation of the conflicting train service S35534 (i.e. Frankfurt Hbf – Tief) is assessed.

As a result, according to the traffic diagram displayed in figure 14.2, the previous train service that departed from the first station on side 1 (i.e. Frankfurt Hbf – Tief) was train service S35532, which departed at 11:24 am without any delay. The subsequent train service may potentially be one of the Yellow trains of line S5 on side 1, turning as train service S35536, which is originally scheduled to depart from Frankfurt Hbf at 12:24 am.

Introducing the necessary information in equation 8.23, the generated service interval after cancelling train service S35534 is equal to:

$$t_{SI_{S35534_{5_1}}^{Frankfurt\ Hbf\ (tief)}} = 12:24 - 11:24 = 60\ min$$

As detailed in subsection 8.4.5, the maximum service interval must also be ascertained. The maximum service interval is described as the service interval for a line's DRP operating concept, considering the existence of any cycle variants. In case of line S5 for side 1, the maximum service interval respective to the cycle variant that reaches the end station of Friedrichsdorf is 30 minutes, as detailed in subsection 14.4.1 (i.e. $t_{SI,max_{S35534_{5_1}}^{Frankfurt\ Hbf\ (tief)}} = 30\ min$).

Finally, if the generated service interval is larger than the maximum service interval the cancellation of the conflicting train service may induce a service conflict. Therefore, as per equation 8.25, since the generated service interval $t_{SI_{S35534_{5_1}}^{Frankfurt\ Hbf\ (tief)}}$ is larger than the maximum service interval $t_{SI,max_{S35534_{5_1}}^{Frankfurt\ Hbf\ (tief)}}$, a service conflict may potentially be generated if trains service S35534 is cancelled.

The approach explained above must be conducted for side 2 of line S5 for all the conflicting train services in the set rc_{5_2} , and, ultimately, across all lines.

Classification of Reachability Conflicts

Finally, it is possible to classify the identified reachability conflict for line S5 on side 1, as per the scheme detailed in table 8.3.

First, line S5 on side 1 has a surplus of vehicles. Second, there is no tuning station within the critical area that would deliver an on-time train service after its early turn (turn). Third, if cancelled, the conflicting train service would potentially generate a service interval higher than the maximum service interval for the line. Thus, the reachability conflict is classified as class number 4 in table 8.3; namely, R-5₁-S-S35534_{5₁} [ETT2/SC2].

14.4.5. Sorting of Line-Specific Conflict into One Single Conflict List

The sorting of all identified line-specific conflicts is conducted for every line and side (if applicable) in correspondence to the three orders of relevance established in subsection 8.5.

The first level concentrates on the projected arrival of the first train of every line at the LtFtS on each side of the disruption. However, in cases none of the trains of the line are projected to reach the LtFtS, the arrival of the first train to the DRP turning station or deviation point is taken under consideration. The second level focuses on the number of measures listed to solve the vehicle availability conflicts, listing at the top the line and side with the most number of measures. The third level focuses on the number of reachability conflicts, listing at the top the line and side with the most number of conflicting trains services.

The projected arrival of the first train of every line at the LtFtS or their respective DRP relevant infrastructural elements is summarized in table 14.5. In the table, the first two columns detail the specific line and side handled in the scenario. The third column details the number of the train services for every line which have been identified to have the earliest arrival at the DRP relevant infrastructural element or the LtFtS. The fourth and fifth columns detail each the specific station and the type of the involved infrastructural component reached by the respective trains services. The sixth column in the table details the project arrival time of the train service at the station specified in the fourth column. The earliest projected arrival time was attained from the source specified in the seventh column of table 14.5.

Table 14.5 Example of the establishment of the earliest projected arrival at the LtFtS or DRP relevant infrastructural element (by author)

Line	Side	Train Number	Station	Type of DRP Relevant Infrastructural Element	Earliest Projected Arrival Time	Source
S1	1	S35135	Griesheim	DRP Deviation Point	12:14 pm	Schedule
S2	1	S35235	Griesheim	DRP Turning Station	12:04 pm	Schedule
	2	S35234	Offenbach Ost	DRP Deviation Point	12:03 pm	Schedule
S3	1	S35335	Frankfurt Hbf (Tief)	LtFtS	12:16 pm	Schedule
	2	S355334	Hauptwache	LtFtS	12:10 pm	Schedule
S4	1	S35435	Frankfurt Hbf (Tief)	LtFtS	12:02 pm	Traffic Diagram
	2	S35434	Hauptwache	LtFtS	12:00 pm	Traffic Diagram
S5	1	S36525	Frankfurt Hbf (Tief)	LtFtS	Already at location	Traffic Diagram

Line	Side	Train Number	Station	Type of DRP Relevant Infrastructural Element	Earliest Projected Arrival Time	Source
	2	No Train Service				Traffic Diagram
S6	1	S35633	Frankfurt Hbf (Tief)	LtFtS	12:00 pm	Traffic Diagram
	2	S35634	Hauptwache	LtFtS	12:08 pm	Traffic Diagram
S8	1	S35833	Frankfurt Hbf (Tief)	LtFtS	12:14 pm	Schedule
	2	S35834	Hauptwache	LtFtS	12:13 pm	Schedule
S9	1	S35933	Frankfurt Hbf (Tief)	LtFtS	11:59 pm	Schedule
	2	S35934	Hauptwache	LtFtS	12:04 pm	Traffic Diagram

The three orders of relevance introduced in subsection 8.5 are applied to the train services detailed in table 14.5, which permits to sort the line-specific conflicts for each of the lines for their respective sides (if applicable) into one single conflict list. The resulting conflict list is depicted in table 14.6.

In table 14.6, the first column details the sorting order of the conflicts (i.e. order in which the conflicts are to be handled) — the second and third columns detail the respective line and side of the sorted conflict.

Table 14.6 Example of a sorted line-specific conflict list (by author)

Conflict N°	Line	Side
1	S5	1
2	S9	1
3	S6	1
4	S4	2
5	S4	1
6	S2	2
7	S9	2
8	S2	1
9	S6	2
10	S3	2
11	S8	2
12	S8	1
13	S1	2
14	S3	1
15	S5	2

During the development of table 14.6, for all lines and sides in which the first trains had the same projected arrival time to the observed infrastructural element detailed in table 14.5 (i.e. LtFtS, DRP turning station and DRP deviation point), the second and even third orders of relevance have been explored as follows:

- In the case of line S4 on side 2 and line S6 on side 1, their first trains arrived at their respective stations at 12:00 pm and the second order of relevance needed to be implemented. However, it was enough to evidence that line S4 on side 2 had no vehicle

availability conflicts identified, while line S6 on side 1 had a surplus of three vehicles (see table 14.4). Thus, line S6 on side 1 was listed first.

- In the case of line S2 on side 1 and line S9 on side 2, their first trains arrived at their respective stations at 12:04 pm. In this case, both lines on the respective sides have no vehicle availability conflict identified. Therefore, the reachability conflicts acquire further relevance (see subsection 8.5). From table 14.4, it is possible to ascertain the number of train services on the opposite side of the disruption for each line, namely, two train on side 2 of line S2 and four trains on side 1 of line 9. Due to the existence of a complete blockage, the number of trains on the opposite investigated side (not driving away from the disruption) would provide a good approximated number of potential reachability conflicts. Therefore, it is expected that line S9 would have a higher number of reachability conflicts as line S2 on side 1. Therefore, line S9 on side 2 is listed first.

14.5. Development of PVSCS

As outlined in figure 3.1, the next module in the system corresponds to the development of PVSCS. The module supports the development of conflict solution alternatives, utilizing information acquired during the classification of the line-specific conflicts discussed in the previous subsection. This subsection utilizes the classified and sorted line-specific conflict list established by the previous module (subsection 14.4) and implements the structured approach for the systematic development of PVSCS (i.e. conflict solution at the line-specific operational level) for every train in the network displayed in figure 9.1.

The PVSCS development is based on a set of handling alternatives that are isolated for every train so as to solve the identified line-specific conflicts of their respective line and side (if applicable). For every combination of different handling alternatives, a PVSCS is developed for the investigated train. The PVSCS is developed utilizing the right-shift rescheduling approach that relies intensively on the train's original schedule, providing the necessary spatiotemporal information.

Aligned with subsections 14.2 and 14.3, this subsection continues to extend the example for line S5 on side 1, while providing an overview for all affected lines and specific cases (i.e. lines that are not divided into two different sides).

In subsection 14.5.1, all trains on side 1 of the disrupted network are appointed with an investigation order, as detailed in subsection 9.3. Later, subsection 14.5.2 provides an example for isolating potential handling alternatives for an investigated train, as discussed in subsection 9.4. Thereafter, in subsection 14.5.3, the example is advanced to support the development of different PVSCS for an investigated train following the framework detailed in subsection 9.5. Finally, in subsection 14.5.4, the technical and operational feasibility of the developed PVSCS in 14.5.3 is verified, as discussed in subsections 9.6 and 9.7.

14.5.1. Establishing an Investigation Order for Trains

The establishment of an investigation order is aligned with the sorting of line-specific conflicts, as detailed in subsection 9.3. The investigation order supports the systematic development of the PVSCS (i.e. conflict solutions), and it is appointed to each of the trains circulating in the network utilizing the similar principles as the first order of relevance detailed for the sorting of line-specific conflicts. This subsection exemplifies the establishment of the investigation order for all trains on side 1 of the disruption scenario detailed in subsection 14.2.

Initially, the projected arrival time of trains to the LtTTS, DRP turning stations or DRP deviation points must be adequately ascertained for all trains clustered in the Yellow and Green categories. This information is later complemented by ascertaining the projected arrival time of trains clustered in the Green+ category to their respective end stations.

The structure and information contained in table 14.5 are utilized as the foundation of the example and expanded on table 14.7 to include the projected arrival at the LtTTS, DRP turning stations or DRP deviation points of all trains on side 1 of the disruption divided network.

Table 14.7 Example of the establishment of the projected arrival of trains to the LtTTS or DRP relevant infrastructural element on one side of a disruption divided network (by author)

Line	Train Number	Train Category	Station	Type of Relevant Infrastructural Element	Projected Arrival Time	Source
S1	S35132	Yellow	Hauptwache	LtTTS	12:08 pm	Schedule
	S35135	Green	Griesheim	DRP Deviation Point	12:14 pm	Schedule
	S35134	Green	Offenbach Ost	DRP Deviation Point	12:23 pm	Schedule
	S35137	Green	Griesheim	DRP Deviation Point	12:44 pm	Schedule
	S35131	Green+	Rödermark O. Roden	End Station	12:03 pm	Schedule
	S35130	Green+	Wiesbaden Hbf	End Station	12:24 pm	Schedule
	S35133	Green+	Rödermark O. Roden	End Station	12:33 pm	Schedule
S2	S35235	Green	Griesheim	DRP Turning Station	12:04 pm	Schedule
	S35237	Green	Griesheim	DRP Turning Station	12:34 pm	Schedule
	S35232	Green+	Niedernhausen	End Station	12:26 pm	Schedule
S3	S35335	Green	Frankfurt Hbf (Tief)	DRP Turning Station	12:16 pm	Schedule
	S35332	Green+	Bad Soden	End Station	12:09 pm	Schedule
S4	S35435	Green	Frankfurt Hbf (Tief)	DRP Turning Station	12:02 pm	Traffic Diagram
	S35437	Green	Frankfurt Hbf (Tief)	DRP Turning Station	12:31 pm	Schedule
S5	S36525	Yellow	Frankfurt Hbf (Tief)	LtTTS	Already at Location	Traffic Diagram
	S35535	Yellow	Frankfurt Hbf (Tief)	LtTTS	12:08 pm	Traffic Diagram
	S36527	Green	Rödelheim	DRP Turning Station	12:12 pm	Schedule
	S35537	Green	Rödelheim	DRP Turning Station	12:27 pm	Schedule
	S36524	Green+	Bad Homburg	End Station	12:03 pm	Schedule
S6	S35633	Yellow	Frankfurt Hbf (Tief)	LtTTS	12:00 pm	Traffic Diagram
	S36627	Green	Frankfurt West	DRP Deviation Point	12:03 pm	Schedule
	S35635	Green	Frankfurt West	DRP Deviation Point	12:16 pm	Schedule
	S36629	Green	Frankfurt West	DRP Deviation Point	12:33 pm	Schedule
	S35632	Green+	Friedberg	End Station	12:10 pm	Schedule
	S36626	Green+	Groß-Karben	End Station	12:17 pm	Schedule
S8	S35833	Green	Frankfurt Hbf (Tief)	DRP Turning Station	12:14 pm	Schedule
	S35835	Green	Frankfurt Hbf (Tief)	DRP Turning Station	12:44 pm	Schedule
	S35830	Green+	Wiesbaden Hbf	End Station	12:10 pm	Schedule
	S35832	Green+	Wiesbaden Hbf	End Station	12:40 pm	Schedule
S9	S35933	Green	Frankfurt Hbf (Tief)	DRP Turning Station	11:59 pm	Schedule
	S35935	Green	Frankfurt Hbf (Tief)	DRP Turning Station	12:29 pm	Schedule
	S35937	Green	Frankfurt Hbf (Tief)	DRP Turning Station	12:59 pm	Schedule
	S35932	Green+	Wiesbaden Hbf	End Station	12:18 pm	Schedule

Table 14.7 contains the information of all 33 trains that circulate on side 1 of the disruption divided network at the moment the dynamic DRP deployment system is being implemented. Since the information regarding trains in the parking locations is not available for the investigated scenario (see subsection 14.3), it is not possible to appoint an investigation ordered to the trains that may be incorporated in the network.

Table 14.8 sorts the trains listed in table 14.7 according to the approach detailed in subsection 9.3 to establish the investigation order $T_{l_s,i}$ of every single train on side 1 of the disruption divided network.

Table 14.8 Example of the allocation of the investigation order for all trains on one side of a disruption divided network (by author)

Train Number	Train Category	Projected Arrival Time	Investigation order
S36525	Yellow	Already at Location	$T_{5,1}$
S35933	Green	11:59 pm	$T_{9,2}$
S35633	Yellow	12:00 pm	$T_{6,3}$
S35435	Green	12:02 pm	$T_{4,4}$
S36627	Green	12:03 pm	$T_{6,5}$
S35235	Green	12:04 pm	$T_{2,6}$
S35535	Yellow	12:08 pm	$T_{5,7}$
S35132	Yellow	12:08 pm	$T_{1,8}$
S36527	Green	12:12 pm	$T_{5,9}$
S35833	Green	12:14 pm	$T_{8,10}$
S35135	Green	12:14 pm	$T_{1,11}$
S35335	Green	12:16 pm	$T_{3,12}$
S35635	Green	12:16 pm	$T_{6,13}$
S35134	Green	12:23 pm	$T_{1,14}$
S35537	Green	12:27 pm	$T_{5,15}$
S35935	Green	12:29 pm	$T_{9,16}$
S35437	Green	12:31 pm	$T_{4,17}$
S36629	Green	12:33 pm	$T_{6,18}$
S35237	Green	12:34 pm	$T_{2,19}$
S35835	Green	12:44 pm	$T_{8,20}$
S35137	Green	12:44 pm	$T_{1,21}$
S35937	Green	12:59 pm	$T_{9,22}$
S36524	Green+	12:03 pm	$T_{5,23}$
S35131	Green+	12:03 pm	$T_{1,24}$
S35332	Green+	12:09 pm	$T_{3,25}$
S35632	Green+	12:10 pm	$T_{6,26}$
S35830	Green+	12:10 pm	$T_{8,27}$
S36626	Green+	12:17 pm	$T_{6,28}$
S35932	Green+	12:18 pm	$T_{9,29}$
S35130	Green+	12:24 pm	$T_{1,30}$
S35232	Green+	12:26 pm	$T_{2,31}$
S35133	Green+	12:33 pm	$T_{1,32}$
S35832	Green+	12:40 pm	$T_{8,33}$

The approach conducted above must be performed analogously for all trains on side 2 of the disruption divided network.

In case of a partial blockage, the projected arrival time of trains to the end station, DRP turning stations, DRP deviation points and LtFTS must also be conducted on each side of the disruption individually, as conducted in table 14.8 for line S1. However, the DRP operating concept of the investigated train's line would determine if the investigation order must recognize between two different sides (see subsection 5.3).

14.5.2. Isolating Potential Handling Alternatives for an Investigated Train

Isolating the potential handling alternatives for every train circulating in the network consists of three processes (see subsection 9.4). First, isolating the accessible infrastructural elements considering the actual location of the investigated trains and their driving direction. Second, establishing a shortlist of potential line-specific conflict solution alternatives for the investigated train. Third, establishing a shortlist of all transition train services that can be appointed to the investigated trains for the adjustment of their circulation plan.

As in previous subsections, the process is exemplified utilizing trains from line S5. Additionally, since the investigation order has already been established for all trains on side 1, the implementation of the processes focuses on side 1 of the disruption divided network.

The following subtitles detail the implementation of each one of the three processes in the investigated scenario.

Isolating Accessible Infrastructural Elements

The understanding of an accessible infrastructural element is provided in subsection 9.4.1. An infrastructural element is considered accessible for an investigated train if it can be reached without the need to change its driving direction. The process of isolating accessible infrastructural elements for an investigated train is based on the train's actual location, its category, and the elements already flagged during the set-up of the DRP operating concept for each of the affected lines (see subsection 14.3.1). In addition, the isolation of accessible infrastructural elements is targeted at each of the train categories and foresees the independent handling of parking locations as well as special operating constraints (e.g. exchange of train crewmembers).

The process of isolating the accessible infrastructural elements is implemented on three trains from line S5 on side 1, which are located at different points in the network at the deployment time $t_{0,TD}$ (i.e. actual location). The three trains are depicted in figure 14.6, which recognizes the investigation order established in subsection 14.5.1 and includes the already flagged infrastructural elements for the respective line, as discussed in subsection 14.3.1.

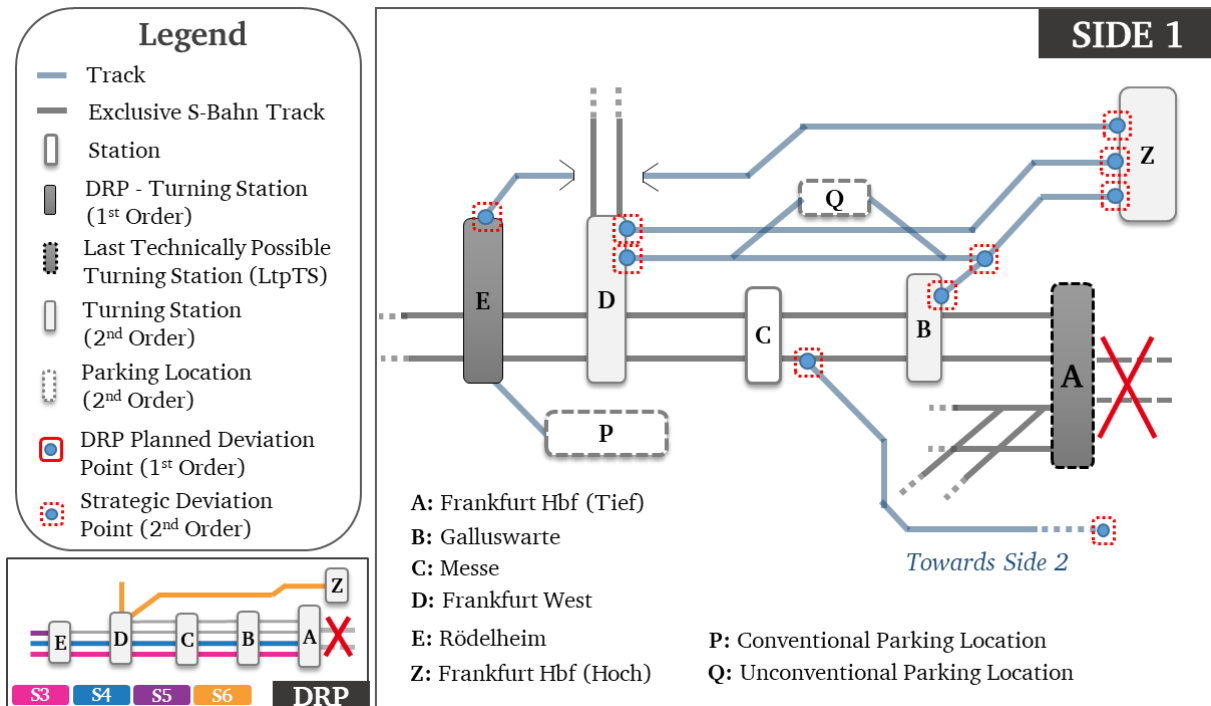

Figure 14.6 General example depicting the isolation of accessible infrastructural elements (by author)

In the case of train service number S36525 (i.e. $T_{5,1,1}$), the train is already located at the LtpTS. Therefore, the LtpTS is the only accessible infrastructural element to be isolated for the investigated train. Nonetheless, since line S5 on side 1 has a surplus of vehicles (see table 14.4), the conventional parking location P (immediately accessible along the line's original route) and an unconventional parking location Q (requires trains to be deviated before it can be accessed), may also be potentially isolated for the investigated train. However, since none of the parking locations is accessible to the investigated train, the parking locations would only be considered if no other trains of the same line have parking locations isolated as accessible infrastructural elements (see subsection 9.4.1).

In the case of train service number S35535 (i.e. $T_{5,1,7}$), the accessible infrastructural elements to be isolated are the: turning station D, deviation points of second-order between station D and station Z, deviation point of second-order to the opposite side of the disruption divided network near station C, turning station B, deviation point of second-order towards station Z and the LtpTS (see figure 14.6). Furthermore, the unconventional parking location Q which must be accessed through a deviation point of second-order in station D is also accessible to train $T_{5,1,7}$.

In the case of a train service number S36524 (i.e. $T_{5,1,23}$), after it has reached its end station, the train may have isolated: all first-order infrastructural elements flagged for its respective train line plus the deviation point of second-order to the opposite side of the disruption divided network near station C and the conventional and unconventional parking locations P and Q. Nevertheless, as for train $T_{5,1,1}$, the parking locations are only considered if no other trains of the same line have the parking locations isolated as accessible infrastructural elements.

As detailed in table 14.4, line S5 on side 1 has a surplus of one train that must be removed from the network in order to solve the vehicle availability conflict. Considering the actual location of all trains of line S5 on side 1, the number of trains which may have the parking locations depicted in figure 14.6 isolated as accessible infrastructural elements are: S35535, S36527 and S35537. While

train service number S35535 (i.e. $T_{5,7}$) is only able to access the unconventional parking location Q, train service numbers S36527 (i.e. $T_{5,9}$) and S35537 (i.e. $T_{5,15}$) are able to access both identified parking locations (i.e. parking location P and Q). If there are enough parking positions available in the conventional parking location P, this location is immediately isolated for trains $T_{5,9}$ and $T_{5,15}$. On the other hand, if no parking positions are available in parking location P, the parking of the additional train must be conducted in the unconventional parking location Q. As a result, parking location Q would be then isolated as an accessible infrastructural element for all three trains, namely, $T_{5,7}$, $T_{5,9}$ and $T_{5,15}$.

Additionally, special cases are also recognized in the approach detailed in subsection 9.4.1. For instance, circumstances in which a specific train would need to reach a particular station due to crew replacement. In case train $T_{5,7}$ is foresaw to exchange its crew at the LtfTS; all other accessible infrastructural elements that have been listed for the train would need to be left aside in order to guarantee that the train would reach the LtfTS.

In the case of a partial blockage, it must be considered that trains are, in principle, able to reach infrastructural elements beyond the disrupted section.

The approach conducted above must be performed analogously for the rest of the trains on both sides of the disruption divided network.

Isolating Potential Line-Specific Conflict Solution Alternatives

The line-specific elemental conflict solutions that may be implemented on specific trains of an investigated line are isolated by considering both: the conflict solution alternatives explored during the classification of the identified line-specific conflicts and the accessible infrastructural elements which have been previously isolated (see subsection 9.4.2).

Initially, as detailed in the identification of the vehicle availability conflict of line S5 on side 1, the line has a surplus of one train (see subsection 14.4.1). The classification of the identified conflict has established that the conflict can be solved by simply removing the surplus train towards conventional or unconventional parking locations (see subsection 14.4.2). As discussed in the previous subtitle, three trains (i.e. $T_{5,7}$, $T_{5,9}$ and $T_{5,15}$) may immediately access at least one of the two considered parking locations. Therefore, the removal and parking of a train is shortlisted as a conflict solution alternative for trains: $T_{5,7}$, $T_{5,9}$ and $T_{5,15}$.

As line S5 on side 1 can solve its vehicle availability conflict by parking any one of its trains at a conventional or unconventional parking location, no other elemental conflict solution alternatives need to be isolated.

Furthermore, line S5 on side 1 has train services positively identified as reachability conflicts, namely, $rc_{S_1} \{S35534\}$ (see subsection 14.4.3). In consequence, potential conflict solution alternatives must be isolated in order to solve the identified conflicts. As detailed in subsection 9.4.2, potential conflict solutions to solve reachability conflicts have already been explored during the classification of the conflict and must be isolated for every investigated train considering the nature of the vehicle availability conflict (i.e. surplus or lack of trains) and its accessible infrastructural elements.

In the case of train $T_{5,1}$, the train has the LtfTS isolated as its sole accessible infrastructural element. Therefore, an early turn isolated may be isolated for the train to solve the identified

reachability conflict at the LtfTS. The early turn of train service number S36525 (i.e. $T_{5,1}$) to solve the reachability conflict has already been projected in the matrix of turn residuals established in subsection 14.4.4. In the matrix, a turn of the investigated train service at the LtfTS and its transitioning towards the conflicting train service $TR_{S36525_{5,1}-S35534_{5,1}}^{FFM Hbf (Tief)}$ results in a train service delayed by 11 minutes.

Since the rest of the trains of line S5 on side 1 that are clustered in the Yellow and Green categories are able to access one or more technically feasible turning stations, they would also have an early turn isolated as an alternative line-specific conflict solution. The early turning of Yellow and Green trains of line S5 on side 1 at turning stations within the network's core area (see figure 3.2) has been projected in the matrix of turn residuals established in subsection 14.4.4.

The approach conducted above must be performed analogously for the rest of the trains on both sides of the disruption divided network by considering the DRP operating concept of each of the affected lines, the classified line-specific conflicts and the accessible infrastructural isolated for every investigated train.

Isolating Transition Train Services

As discussed in subsection 9.4.3, the isolation of transition train services for an investigated train depends on the category in which the train has been clustered, the DRP operating concept of the investigated train's line, the isolated line-specific elemental conflict solutions and the train services that are being serviced by other trains at the time the system is implemented.

In the case of train service number S36525 (i.e. $T_{5,1}$), the train's actual location is the LtfTS, and it is clustered in the Yellow category. The approach detailed in subsection 9.4.3 foresees considering two prior and two subsequent train services as a range of potential transition train services. Therefore, according to the line's schedule and since the DRP operating concept does not foresee the cancelling of any of the train services of the line, the following four transition train services may be considered to adjust the investigated train's circulation plan:

- Train service S36524 scheduled to depart at 11:39 am from Frankfurt Hbf (Tief) in direction Bad Homburg
- Train service S35534 scheduled to depart at 11:54 am from Frankfurt Hbf (Tief) in direction Friedrichsdorf
- Train service S36526 scheduled to depart at 12:09 pm from Frankfurt Hbf (Tief) in direction Bad Homburg
- Train service S36536 scheduled to depart at 12:24 pm from Frankfurt Hbf (Tief) in direction Friedrichsdorf

From the four transition train services isolated for train $T_{5,1}$, train service S36524 is already being serviced on side 1 of the disruption dived network by train $T_{5,23}$ (see table 14.7). Therefore, train service S36524 can be immediately discarded as a potential alternative. Furthermore, train service S35534 has already been isolated for the train as the means to solve the sole reachability conflict identified for line S5 on side 1. Consequently, it is not necessary to isolate train service S35534 once again. At last, train services S36526 and S36536 are not serviced by any other train nor have been isolated as reachability conflicts; thus, they are isolated as the set of potential transition train services for train $T_{5,1}$.

In the case of train service number S35535 (i.e. $T_{5,7}$), the results are very similar to those already established for train S36525 (i.e. $T_{5,1}$). The only difference between train $T_{5,1}$ and train $T_{5,7}$ is that train $T_{5,7}$ starts its range with train service S35534, includes train services S36526, as well as S36536 and finishes in:

- Train service S36528 scheduled to depart at 12:39 pm from Frankfurt Hbf (Tief) in direction Bad Homburg

In the case of train service number S36524 (i.e. $T_{5,23}$), the train's actual location is the station Oberursel, and it is clustered in the Green+ category. The approach detailed in subsection 9.4.3 foresees considering two subsequent train services as a range of potential transition train services at the end station. Therefore, according to the line's schedule and since the DRP operating concept does not foresee the cancelling of any of the line's train services, the following two transition train services may be considered to adjust the investigated train's circulation plan:

- Train service S36529 scheduled to depart at 12:30 pm from Bad Homburg in direction Rödelheim
- Train service S36531 scheduled to depart at 12:59 pm from Bad Homburg in direction Rödelheim

Since none of the two transition train services are being serviced by any other train on the same side or have been cancelled by the DRP operating concept, both are isolated as the set of potential transition train services for train $T_{5,23}$.

In case of a partial blockage or for lines divided into different sides by the DRP operating program, all train services foreseen by the DRP must be supported separately on either side of the disrupted section. However, if the operating program does not foresee the separation of the line into different sides, all train services are supported and handled together as it is the case for line S1.

The approach conducted above must be performed analogously for the rest of the trains on both sides of the disruption divided network.

14.5.3. Node-to-Node Development of the PVSCS

The development of the different PVSCS for every train circulating in the network is conducted by appointing a baseline-PVSCS to an investigated train over which its handling alternatives already isolated in subsection 14.5.2 may be selected and combined. The baseline-PVSCS relies mainly on the spatiotemporal information contained in the original schedule of an investigated train and incorporates certain modifications that permit to enhance the quality of the resulting PVSCS (see subsection 9.5.1).

As in previous subsections, the process is exemplified utilizing trains from line S5 on side 1 of the disruption divided network. The following two subtitles detail, first, the appointment of the baseline-PVSCS, and second, the development of the PVSCS.

Baseline-PVSCS

As discussed in subsection 14.3.2, the baseline-PVSCS is, in principle, constituted by the spatiotemporal information contained in the schedule of an investigated train (i.e. arrival and departure times from a string of nodes). However, to support the existence of a disruption and the DRP operating concept, certain modifications are introduced in the original schedule of the

investigated trains. The modifications are introduced by considering the category in which the investigated trains have been clustered.

Since train services S36525 (i.e. $T_{5,1}$) and S35535 (i.e. $T_{5,7}$) are clustered in the Yellow category (see table 14.3), the baseline-PVSCS of each of the trains foresees the introduction of one slight modification in the original schedule of the trains. As discussed in subsection 9.5.1, the platform tracks at turning stations must be aligned according to the schedule of the transition train service chosen to develop each of their PVSCS. However, it must be noted that as train $T_{5,1}$ is already located at the LtfTS, its platform track at the turning station cannot be changed anymore.

In the case of train service number S35537 (i.e. $T_{5,15}$), the train's actual location is the station Friedrichsdorf, and it is clustered in the Green category. As with the previous case, certain modifications are introduced in the train's original schedule. As discussed in subsection 9.5.1, for Green trains, the changes foreseen in the DRP operating program must be supported (e.g. changes detailed in table 14.1). Table 14.1 does not provide any explicit guidelines to modify the route of any train at the DRP turning station appointed to line S5 on side 1. Therefore, as discussed in subsection 9.5.1, the platform tracks at the DRP turning stations are also aligned with the schedule of the transition train service chosen to develop the PVSCS.

A particularly relevant example of the necessary changes on the original schedule of a train according to the DRP operating concept of a line is found in train S35335 $T_{3,12}$. Table 14.1, provides a detailed guideline for supporting the adjustment of the schedule of train $T_{3,12}$ as it drives in and out of its DRP turning station.

The approach conducted above must be performed analogously for the rest of the trains on both sides of the disruption divided network.

Development of PVSCS

As discussed in subsection 9.5.2, the development of every PVSCS for an investigated train is conducted in three steps: a guided selection of elements from the train's list of isolated handling alternatives (see subsection 14.5.2), the establishment of constraints derived from the selected handling alternatives, and a node-to-node development of the PVSCS acknowledging the established constraints.

In the case of train service number S36525 (i.e. $T_{5,1}$), the train has as its actual location the LtfTS and no other accessible infrastructural elements have been isolated. Furthermore, the train has an early turn isolated as a measure to potentially solve the reachability conflict identified for its line. At last, the train has three potential transition train services to adjust its circulation plan (see subsection 14.5.2). By selecting the early turn train of train S36525 at the LtfTS to the first transition train service in the list (i.e. train service S35534), the train can have its first PVSCS $d_{T_{5,1}}$ developed.

The development of PVSCS $d_{T_{5,1}}$ is depicted in figure 14.7. As discussed in subsection 9.5.2, the development of a PVSCS must consider eight aspects:

- *Temporal requirements:* the developed PVSCS must support the minimum turning time (i.e. 6 minutes for one driver and 2 minutes for two drivers), as discussed in subsection 3.6.2. By assuming the train has only one driver, the minimum turning time is equal to 6 minutes.

- *Adjustment of the Circulation Plan:* the train's current circulation plan must be first adjusted to include train service S35534. Subsequently, since the DRP operating concept of the line does not foresee the cancellation of any scheduled train service, the rest of the circulation plan must be adjusted according to the lineaments discussed in subsection 9.5.2.
- *Initial delay:* the train's initial delay must be introduced in the baseline-PVSCS. In the case of train service S36525, the initial delay results from the difference between the train's scheduled and projected arrival to the station Frankfurt Hbf (Tief), registered at the moment in which the system is being implemented.
- *Threading-in and threading-out times:* not applicable
- *Additional stopping times:* not applicable
- *Modifying the projected arrival and departure times:* the departure time of the transition train service (i.e. train service S35534) from the turning station must be established by supporting the projected arrival of the train to the turning station and the minimum turning time. However, since the train is already at the turning station, the adjustment only focuses on the minimum turning time. A delayed departure of the transition train service from the turning station must be accordingly adjusted throughout the rest of its route (i.e. for every node).
- *Involvement of other trains due to coupling as a line-specific conflict solution:* not applicable
- *Involvement of other trains due to decoupling as a line-specific conflict solution:* not applicable

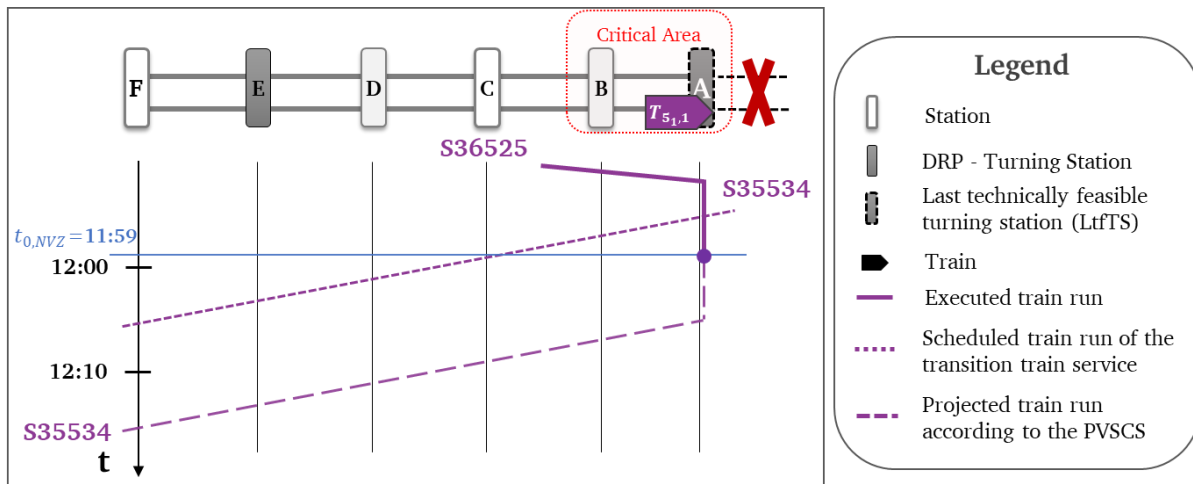

Figure 14.7 General example depicting the node-to-node development of a PVSCS (by author)

The remaining PVSCS for train $T_{5,1}$ utilizing the remaining two transition train services must be generated analogously, as it has been conducted for the example explained above and depicted in figure 14.7.

In the case of train service number S35535 (i.e. $T_{5,7}$), the train has four turning stations, a deviation route and an unconventional parking location isolated as accessible infrastructural elements (see subsection 14.5.1). Additionally, the train has an early turn and its removal from the network isolated as potential measures for developing its different PVSCS. At last, four potential transition train services have been isolated for the train, as discussed in subsection 14.5.2. By selecting the parking of train $T_{5,7}$ at the parking location Q the first PVSCS (i.e. $d_{T_{5,i}}$) for the train can be developed: $d_{T_{5,7}}$.

The development of PVSCS $d_{T_{51,7}}$ is depicted in figure 14.8. As discussed above, the development of a PVSCS must consider eight aspects:

- *Temporal requirements:* the developed PVSCS must support the minimum time for emptying the train, as detailed in subsection 6.3.3. Since the train would terminate its journey at station D (before driving through the deviation point – see figure 14.8), the train does not need to change its driving direction to proceed to the parking location. Thus, the recommended minimum time for emptying the train is 12.5 minutes (see subsection 3.6.2).
- *Adjustment of the Circulation Plan:* as the train is to be parked, the current circulation plan of the train must be totally removed, and no further action is required. However, the shunting movements towards the parking location must be scheduled and supported with a train number to control the movement of the train throughout the network (see figure 14.8).
- *Initial delay:* the train's initial delay must be introduced in the baseline-PVSCS.
- *Threading-in and threading-out times:* as discussed in subsection 9.5.2, the threading-in time of the train to the deviation route cannot be support at this stage.
- *Additional stopping times:* not applicable
- *Modifying the projected arrival and departure times:* the departure time of the train from station D towards the parking location must be adjusted to support the minimum time for emptying the train. Furthermore, since the PVSCS foresees routing the train outside of its scheduled route, the journey time through the deviation route up to its parking location must be derived based on the departure time of the train from station D and utilizing the information from the infrastructure modelling respective to the model train (see subsection 5.1).
- *Involvement of other trains due to coupling as a line-specific conflict solution:* not applicable
- *Involvement of other trains due to decoupling as a line-specific conflict solution:* not applicable

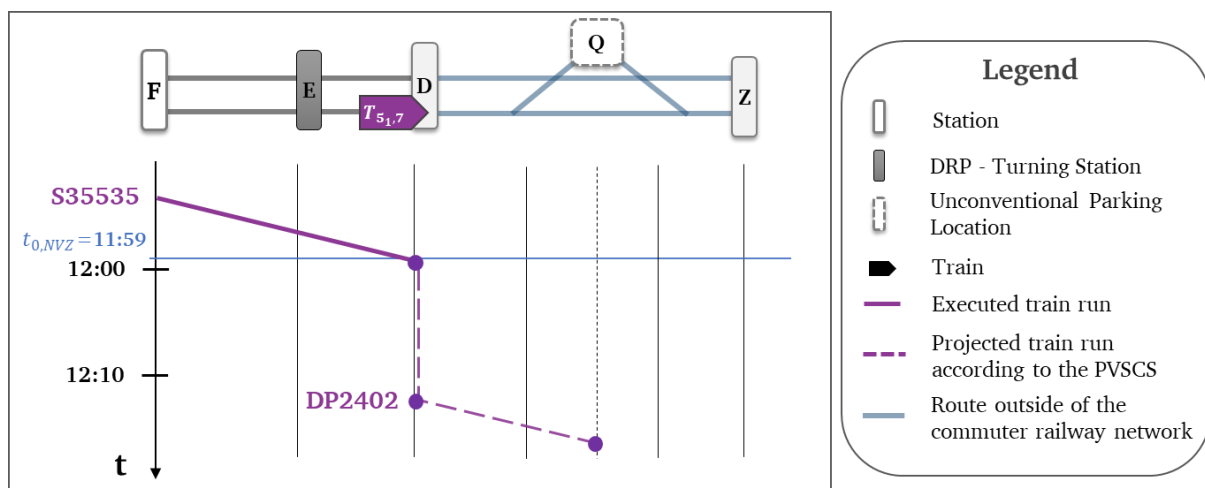

Figure 14.8 General example depicting the node-to-node development of a PVSCS with shunting movements (by author)

The remaining PVSCS for train $T_{51,7}$ that foresee the selection of the turning stations and transition train services isolated for the train must be generated analogously, as exemplified for train $T_{51,1}$.

The approach conducted above must be performed for the rest of the trains on both sides of the disruption divided network.

14.5.4. Verification of the Technical and Operational Feasibility of PVSCS

The verification of the technical and operational feasibility of the developed PVSCS is conducted individually for each PVSCS. The verification process starts with a verification of the technical feasibility of a PVSCS which is then followed by a verification of its operational feasibility (see subsections 9.6 and 9.7)

As in previous subsections, the process is exemplified utilizing trains from line S5 and on side 1 of the disruption divided network. The following subtitles detail the verification of the technical and operational feasibility of the developed PVSCS.

Verification of the Technical Feasibility

The technical feasibility of the developed PVSCS is verified by utilizing absolute and soft exclusion criteria. The criteria handled at each one of these two levels have been adeptly explained in subsection 9.6. Since the implementation of these criteria is straightforward, no further exemplification is necessary.

Verification of the Operational Feasibility

The verification of the operational feasibility is conducted at two different levels depending on the measure utilized to develop the PVSCS. The first level is reserved for PVSCS that foresee the early turning of an investigated train at one of its isolated turning stations. The second level verifies the overall ability to reduce any existing delay in the investigated PVSCS, which may have been induced due to the disruption or the combination of chosen handling alternatives.

For the PVSCS $d_{T_{5,1,1}}$ developed for train service number S36525 (i.e. $T_{5,1,1}$) and depicted in figure 14.7, the operational verification is conducted across the two operational levels, as the PVSCS foresees the early turning of the train at the LtFTS.

As discussed in subsection 9.7.1, at the first level, the verification relies on the turn residual (see subsection 3.6.2) to ascertain if the early turn delivers an on-time or a delayed train.

Since the selected transition train service (i.e. train service S35534) for the development of PVSCS $d_{T_{5,1,1}}$ is included in the line's set of reachability conflicts; the turn residual has already been calculated during the classification of the conflict (see subsection 14.4.4). Nonetheless, the turn residual is still computed as detailed in equation 9.1, considering the turn of train $T_{5,1,1}$ at the turning station (i.e. LtFTS) towards the transition train service S35534.

$$TR_{T_{5,1,1}-S35534}^{Frankfurt\ Hbf\ (Tief)} = 11:54 - 11:52 - 7\ min - 6\ min = -11\ min$$

According to the guidelines detailed in subsection 9.7.1, if equation 9.1 yields a negative value, a negative turn has been generated (see subsection 3.6.2). Any negative turn must be further verified to check if the induced delay falls within the threshold that would still permit to consider the transition train service as being on-time. As discussed in subsection 3.6.2, the recommended value for the threshold is up to 6 minutes (i.e. $t_{ot} = -6min$). Therefore, if the delay is up to six minutes, the investigated PVSCS can be immediately introduced in the PVSCS set $D_{T_{l_s,i}}$ of the respective

train. However, since the delay computed through equation 9.1 is far beyond 6 minutes, the second level in the operational verification must be conducted.

As discussed in subsection 9.7.2, at the second level, the verification concentrates on the ability of the train to reduce any existing delay at its end station located the furthest from the disrupted section. Since the scheduled transition between train services is generally larger than the minimum transition time, the buffer time built-in the scheduled at the end station (the furthest from the disrupted section) may permit to reduce any existing delay. Thus, the verification ascertains if the existing delay may be reduced due to the transition between train services at the end station. A train can reduce its delay if, at the end station, the transition train service according to the train's adjusted circulation plan, is able to depart with a delay within the on-time threshold. The verification is computed as detailed in equation 9.2.

For the introduction of the respective values in equation 9.2, the projected arrival of the train to its scheduled end station $t_{Proj.Arr}^{Friedrichsdorf S35534}$ is ascertained by adding the induce delay after the train's turn in Frankfurt Hbf (Tief) (i.e. 11 min) to the train's scheduled arrival at its end station (i.e. Friedrichsdorf).

$$t_{Sch.Dep}^{Friedrichsdorf S35539} - t_{Proj.Arr}^{Friedrichsdorf S35534} - \min t_{Turn} \geq t_{Ot} \rightarrow$$

$$12:38 - (11 \text{ min} + 12:20) - 6 \text{ min} \geq -6 \text{ min} \rightarrow 1 \text{ min} \geq -6 \text{ min}$$

By applying equation 9.2, it is possible to ascertain that after train service S35534 has transitioned at its scheduled end station to the train service detailed in its adjusted circulation plan (i.e. train service S35539 – according to the guidelines detailed in subsection 9.5.2 and the original schedule), the resulting train service would have no further delay. Therefore, equation 9.2 is satisfied, and the delay has been completely reduced. Finally, according to the guidelines detailed in subsection 9.7.2, the investigated PVSCS $d_{T_{5,1}}$ can be immediately introduced in the PVSCS set for the respective train (i.e. $D_{T_{5,1}}$).

On the other hand, if equation 9.2 is not satisfied, one more operational verification at the same level is necessary. This last verification is exemplified utilizing the example of PVSCS $d_{T_{5,1}}$ as a baseline. For this, it is necessary to increase the delay with which train service S35534 arrives at the end station Friedrichsdorf such that the transition train service S35539 starts with a delay outside the on-time threshold. For this, the turn residual calculated for a turn of train service S36525 towards train service S35534 at the LtFTS would need to result in a negative turn with a value above 18 minutes. In this case, train service S35534 would reach its scheduled end station with delay above 18 minutes, and the buffer time built-in the schedule would not be able to reduce the delay sufficiently enough such that transition train service S35539 departs from Friedrichsdorf within the on-time threshold.

If the buffer time is not able to reduce the delay sufficiently enough, one last verification is necessary before the PVSCS is potentially rejected. The operational verification is conducted as if the investigated PVSCS foresees an early turn one station prior to the scheduled end station (the furthest away from the disrupted section).

Thus, if train service S35534 is delayed above 18 minutes as exemplified above, an early turn of train service S35534 at one station prior to its scheduled end station (i.e. station Seulberg) is projected in the PVSCS. The scheduled arrival of train S35534 at station Seulberg (one station

prior to the end station) is 12:19 pm. Additionally, the scheduled departure of train service S35539 from station Seulberg is 12:41 pm. Therefore, with an early turn of train service S35534 at station Seulberg, the transition train service S35539 would be able to start its service with a delay within the on-time threshold (i.e. $-2min$, computed with equation 9.2). The handling of the verified PVSCS and its introduction in the investigated train's PVSCS set is discussed in subsection 9.7.2.

The approach conducted above must be performed for all developed PVSCS, with the sole exception of PVSCS that foresee the removal of the investigated train out of the network without the need to change its driving direction. An example of such a PVSCS is depicted in figure 14.8.

14.6. Combination of PVSCS

As outlined in figure 3.1, the next module in the system foresees the combination of the developed PVSCS. This module supports the assembly of PVSCS combinations, which are later fixed so as to attain the conflict-free schedules. This subsection utilizes the PVSCS established in the previous module (subsection 14.5) and implements the structured approach for the systematic assembly of the PVSCS combinations displayed in figure 10.4.

Aligned with previous subsections, this subsection continues to extend the example on side 1 of the disruption divided network while providing an overview of all affected lines and specific cases (i.e. lines that are not divided into two different sides).

In subsection 14.6.1, according to the structured approach, an example of the establishment of an initial PVSCS combination is presented (see subsection 10.4). Later, subsection 14.6.2 provides an example for the establishment of an optimal entrance sequence to the LtFTS (see subsection 10.5). Thereafter, in subsection 14.6.3, an example is advanced to support the assembly of PVSCS combinations through the Genetic algorithm (see subsection 10.6).

14.6.1. Establishing an Initial PVSCS Combination

As established in the structured approach, the module starts with the assembly of an initial PVSCS combination. The initial PVSCS combination constitutes the upper bound for the subsequent assembly of further PVSCS combinations conducted through the Genetic algorithm (see figure 10.4).

The assembly of the initial PVSCS combination $I_{S,1}$ is conducted following four steps as detailed in subsection 10.4.2. When applied to side 1 of the investigated scenario, individual PVSCS must be selected from the PVSCS sets across all 33 trains that circulate on side 1 of the disruption divided network (see subsection 14.5.1).

The four-step process begins by selecting the first PVSCS in the PVSCS set of the first train following the investigation order of side 1 (i.e. $T_{l_{S=1},i=1}$). The selected PVSCS is introduced in the initial combination $I_{1,1}$. In the PVSCS set of train $T_{5,1}$, the first PVSCS $d_{T_{5,1}}$ foresees its turn at the LtFTS towards train service S35534 (see subsection 14.5.3).

The second step foresees the selection of the first PVSCS in the PVSCS set of the next train according to the investigation order of side 1 (i.e. $T_{l_{S=1},i=2}$). Therefore, the first PVSCS $d_{T_{9,2}}$ in the PVSCS set of train $T_{9,2}$ (i.e. train service S35933) must be selected. Later, in the third step, the operational compatibility of the selected PVSCS is verified against the PVSCS which already forms

part of the initial combination $I_{1,1} \{d_{T_{5,1}}\}$. According to operational compatibility definition introduced in subsection 10.4.1, since train $T_{9,2}$ belongs to a different line when compared to train $T_{5,1}$, the selected PVSCS would most likely be compatible with the already existing PVSCS in the combination (i.e. $d_{T_{5,1}}$). Therefore, PVSCS $d_{T_{9,2}}$ may also be introduced in the initial combination $I_{1,1} \{d_{T_{5,1}}, d_{T_{9,2}}\}$.

The process circles back to step 2 until all 33 trains on side 1 have had one PVSCS selected from their respective PVSCS set. However, once a PVSCS for a train of the same or corresponding lines is selected (also taking into consideration the assembly of the PVSCS combination on side 2), the verification of operational compatibility plays a critical role.

An example of an operationally incompatible selection of a PVSCS may be advanced by observing the parking of trains at the unconventional parking location Q. If the parking location has enough space to park only one vehicle combination, the initial PVSCS combination may contain only one PVSCS that foresees the parking of a train at such location. As discussed in subsection 14.5.3, the first PVSCS for train $T_{5,7}$ (i.e. $d_{T_{5,1}}$), foresees the parking of the train at the unconventional parking location Q. In case the first PVSCS of train $T_{5,9}$ also foresees the parking of the train at the unconventional parking location Q, the selection of this PVSCS would be operationally incompatible with the already existing PVSCS in the initial combination.

According to the process detailed in subsection 10.4.2, if the last selected PVSCS is operationally incompatible, the next PVSCS in the train's PVSCS set must be selected. Thus, if the second PVSCS (i.e. $e_{T_{5,9}}$) in the PVSCS set of train $T_{5,9}$ foresees the turning of the train at its DRP turning station, the PVSCS would be compatible with the existing PVSCS in the initial combination.

Furthermore, once the iterative process reaches train $T_{5,15}$, if the first PVSCS of the train in its PVSCS set foresees the parking of the train in any of the available parking locations, the selection would also be operationally incompatible, as line S5 on side 1 only needs to remove one train to solve its vehicle availability conflict. Therefore, the next PVSCS, in the PVSCS set of train $T_{5,15}$ must be selected. In this case, the verification of the operational compatibility would focus on the train services in the adjuted circulation plan of the chosen PVSCS. As discussed in subsection 10.4.2, the circulation plan of the chosen PVSCS for the train cannot contain any train service that is already contained within the circulation plans of the PVSCS previously introduced in the combination (i.e. train $e_{T_{5,9}}$). The selection is conducted until a PVSCS that is operationally compatible with the PVSCS already introduced in $I_{1,1}$, is selected. In case no compatible PVSCS in the PVSCS set of a train is operationally compatible, step 4 of the process detailed in subsection 10.4.2, must be executed.

It must be considered that the initial combination is constructed simultaneously for both sides of the disruption (if applicable) (see subsection 10.3.2). Since the selection process of individual PVSCS in the sets of PVSCS of every train follows the investigation order, the establishment of the initial combination in case of a partial blockage is conducted as exemplified throughout this subsection.

14.6.2. Optimal Entrance Sequence – Tabu Search

Once a PVSCS combination $I_{s,o}$ has been assembled, an optimal entrance sequence of the queuing trains to the LtfTS must be established. According to the module's structured approach, the optimal entrance sequence is only ascertained for an infrastructural layout of type 2 or higher (see figure 14.3).

The Tabu Search algorithm that supports ascertaining the optimal entrance sequence of queuing trains to the LtfTS is summarized in the ten steps detailed in subsection 10.5. The ten steps are exemplified in the following subtitles.

Since side 2 of the disruption divided network has an infrastructure layout of type 1 (see figure 10.1), the Tabu Search algorithm is only applicable for PVSCS combinations generated for side 1 of the disruption divided network.

Establishing the Initial (FCFS) Entrance Sequences for Queuing Trains in a Combination

The first step consists in ascertaining the fitness R^* of an incumbent solution based on an initial entrance sequence of queuing trains to the LtfTS. The fitness is computed as detailed in section 12, by making the PVSCS combination conflict-free (see section 11) while respecting the entrance sequence of queuing trains to the LtfTS. Since the purpose of this subsection is to exemplify the implementation of the Tabu Search algorithm, the focus is on the establishment of the initial entrance sequence of queuing trains to the LtfTS.

The establishment of the initial entrance sequence of queuing trains to the LtfTS is detailed in subsection 10.5.1. According to the approach, all trains in the investigated PVSCS combination $I_{s,o}$ that have the LtfTS in their selected PVSCS are considered to be potential queuing trains. The initial entrance sequence of all potential queuing trains is established through an FCFS principle.

According to the approach, only the first arrival detailed in the selected PVSCS of the potential queuing trains to the LtfTS is taken under consideration. This implies that the arrival of any subsequent train service in their adjusted circulation plans is not taken under consideration. Once the first arrival of every potential queuing train to the LtfTS has been established, the arrival time to the LtfTS is registered as the one detailed in each train's PVSCS utilized to assemble the investigated PVSCS combination.

The establishment of an initial entrance sequence for queuing trains to the LtfTS is exemplified utilizing the cases handled in subsection 14.6.1. Therefore, an initial entrance sequence is established for the initial PVSC combination on side 1 of the disruption divided network (i.e. $I_{1,1}$).

Furthermore, since neither the PVSCS for every train on side 1 nor the complete initial PVSCS combination have been developed in the previous subsection, the information displayed on tables 14.7 and 14.8 is utilized to ascertain the trains that have the potential to queue in front of the LtfTS. While utilizing the information detailed on both tables would permit to ascertain an arrival time of the trains to the LtfTS, it would also neglect the necessary modifications that need to be introduced to the baseline-PVSCS so as to support the development of each of the trains' PVSCS according to the DRP operating concept or the accessed infrastructural elements. For instance, in the case of trains that belong to line S3 and line S4, according to table 14.1, their scheduled routes should have been altered as they drive in the LtfTS. Nonetheless, the projected arrival according to the unmodified schedule, is expected to deliver an example with sufficient accuracy.

Therefore, with the exception of the train $T_{5,1,7}$, which according to subsection 14.6.1 should be removed from the system as foreseen by the PVSCS included in the initial combination $I_{1,1}$, the remaining 32 trains circulating on side 1 are considered to reach their respective end or DRP turning stations (see subsection 9.3). As a result, table 14.9 details the potential queuing trains on side 1 for a fictitious initial PVSCS combination, including the time of their first scheduled arrival to the LtfTS. Table 14.9 also details the investigation order of the trains for side 1 (first column), the train service number (third column), the train category (fourth column), the link utilize to access the LtfTS (seventh column) and the resulting fixed (i.e. queuing) order of arrival to the LtfTS (eighth column).

The potential queuing trains are distinguished to recognize the incoming links q they utilize to reach the LtfTS. Link $q = 1$ is referred to as to the set of tracks connecting the LtfTS (i.e. Frankfurt Hbf - Tief) with the station Galluswarte (see figure 14.4). As detailed in table 14.9, through link $q = 1$, a total of six potential queuing trains access the LtfTS. Link $q = 2$ is referred to as the set of tracks connecting the LtfTS (i.e. Frankfurt Hbf - Tief) with a junction in the vicinity of Frankfurt Hbf (Tief) that is at the same time linked to stations Griesheim and Niederrad (see figure 14.4). As detailed in table 14.9, utilizing link $q = 2$, a total of eight potential queuing trains access the LtfTS.

Table 14.9 Example of the establishment of potentially queuing trains per incoming link (by author)

Train	PVSCS	Train Number	Train Category	PVSCS Scheduled Arrival Time to the LtfTS	Incoming Link (q)	Fixed Order (h)	Source
$T_{5,1,1}$	$d_{T_{5,1,1}}$	S36525	Yellow	Already at Location	1	0	Traffic Diagram
$T_{9,1,2}$	$d_{9,1,2}$	S35933	Green	11:59 pm	2	1	Schedule
$T_{6,1,3}$	$d_{T_{6,1,3}}$	S35633	Yellow	12:00 pm	1	2	Traffic Diagram
$T_{4,1,4}$	$d_{T_{4,1,4}}$	S35435	Green	12:02 pm	1	3	Traffic Diagram
$T_{8,1,10}$	$d_{8,1,10}$	S35833	Green	12:14 pm	2	4	Schedule
$T_{3,1,12}$	$d_{T_{3,1,12}}$	S35335	Green	12:16 pm	1	5	Schedule
$T_{9,1,16}$	$d_{9,1,16}$	S35935	Green	12:29 pm	2	6	Schedule
$T_{4,1,17}$	$d_{T_{4,1,17}}$	S35437	Green	12:31 pm	1	7	Schedule
$T_{8,1,20}$	$d_{8,1,20}$	S35835	Green	12:44 pm	2	8	Schedule
$T_{3,1,25}$	$d_{T_{3,1,25}}$	S35337	Green+	12:46 pm	1	9	Schedule
$T_{9,1,22}$	$d_{9,1,22}$	S35937	Green	12:59 pm	2	10	Schedule
$T_{8,1,27}$	$d_{8,1,27}$	S35837	Green+	13:14 pm	2	11	Schedule
$T_{9,1,29}$	$d_{9,1,29}$	S35939	Green+	13:29 pm	2	12	Schedule
$T_{8,1,33}$	$d_{8,1,33}$	S35839	Green+	13:44 pm	2	13	Schedule

The last column of table 14.9 details the order of arrival of the potential queuing trains to the LtfTS following an FCFS principle. From the fixed order h detailed in the last column of table 14.9, the initial entrance sequence ($u = 1$) to the LtfTS for every potential queuing train $T_{l_s,i}^h$ in the investigated PVSCS combination $I_{1,1}$ results in:

$$u = \{ T_{9,1,2}^1, T_{6,1,3}^2, T_{4,1,4}^3, T_{8,1,10}^4, T_{3,1,12}^5, T_{9,1,16}^6, T_{4,1,17}^7, T_{8,1,20}^8, T_{3,1,25}^9, T_{9,1,22}^{10}, T_{8,1,27}^{11}, T_{9,1,29}^{12}, T_{8,1,33}^{13} \}.$$

It must be noted that since train $T_{5,1,1}$ is already at the LtfTS, it is not necessary to assign it with an order in the entrance sequence.

The initial entrance sequence of the potential queuing trains to the LtfTS is established similarly for any PVSCS combination that needs to be handled through the Tabu Search regardless of the side.

Determining the Size of the Tabu Lists

The second step consists in ascertaining the size of the long-term and the short-term Tabu lists. The size of these lists is ascertained utilizing the example advanced in the previous subtitle.

Initially, the total number of possible entrance sequences $U_{I_{S,o}}$ for the initial PVSCS combination $I_{1,1}$ is ascertained (i.e. $U_{I_{1,1}}$) through equation 10.1, utilizing the information detailed in table 14.9.

$$U_{I_{1,1}} = \frac{13!}{5! * 8!} = 1287$$

The total number of possible entrance sequences (i.e. $U_{I_{1,1}} = 1287$) also represents the size of the search space to be explored by the Tabu Search algorithm. As discussed in subsection 10.5.2, the total number of possible sequences is equal to the size of the long-term list $L_{U_{I_{S,o}}}$ (i.e. $L_{U_{I_{1,1}}} = 1287$).

Later, respecting the sequence constraints per each of the incoming links q (no overtake permitted) and the number of trains per link H_q , the total number of swaps $P_{I_{S,o}}$ for the initial PVSCS combination $I_{1,1}$ is calculated (i.e. $P_{I_{1,1}}$). The total number of swaps is calculated with equation 10.3, utilizing the information detailed in table 14.9.

$$P_{I_{1,1}} = \frac{13!}{2(13-2)!} - \frac{5!}{2(5-2)!} - \frac{8!}{2(8-2)!} = 40$$

The total number of possible swaps (i.e. $P_{I_{1,1}} = 40$) represents the size of neighbouring movements that can be explored at a time. As discussed in subsection 10.5.2, the number of neighbouring movements is also the size of the short-term list $L_{P_{I_{S,o}}}$.

However, to make the algorithm more efficient, the short-term list is reduced in size in correspondence to the total number of potential queuing trains, as detailed in equation 10.6. Since the total number of potential queuing trains is less than 30 (see table 14.9, $H = 13$), the size of the short-term list is recommended to be maintained between 7 and 5 elements. In order to ensure a more thorough exploration of neighbouring solutions, the size of the short-term list is kept at 7 elements (i.e. $L_{P_{I_{S,o}}} = 7$).

Ranking Candidate Swaps in a List

The third step consists in the ranking of all possible swaps ($P_{I_{1,1}} = 40$) in a list $L_{Cw_{I_{S,o}}}$, so that the algorithm is able to prioritize movements with a higher likelihood to improve the initial FCFS solution. The ranking of the candidate swaps is conducted in the seven steps, as detailed in subsection 10.5.3.

The ranking process focuses on establishing the difference in the scheduled arrival time $a_{T_{I_{S,i}}^h - T_{I_{S,j}}^r}$ of two trains that can have their entrance sequence swapped between each other as they access the LtfTS. For example, the entrance of train $T_{6,1,3}^2$ to the LtfTS may be swapped with $T_{8,1,10}^4$. The

difference in the scheduled arrival time of these trains $a_{T_{61,3}^2-T_{81,10}^4}$ is ascertained by means of equation 10.7.

$$a_{T_{61,3}^2-T_{81,10}^4} = |12:00 - 12:14| = 14min$$

The difference in the arrival time permits to appreciate the approximated amount of time train $T_{61,3}^2$ may need to wait for the arrival of train $T_{81,10}^4$ before it enters the LtfTS.

The difference in the scheduled arrival time $a_{T_{i_s,i}^h-T_{j_s,j}^r}$ for all possible train swaps are ranked in a list for the investigated PVSCS combination (i.e. $L_{CW_{I_{1,1}}}$). The list ranks at the top of the list the swaps with the minimum difference in the scheduled arrival time. The raking is conducted by following further ranking guidelines as detailed in subsection 10.5.3.

Selecting a Pair of Trains from the List

The fourth step consists of selecting a pair of trains to be swapped from the ranked list $L_{CW_{I_{1,1}}}$. However, to make the Tabu search algorithm even more efficient, elite candidate swaps are established in the ranked list $L_{CW_{I_{1,1}}}$ (see subsection 10.5.4).

To establish the elite candidate swaps, the ranked list $L_{CW_{I_{1,1}}}$ is partitioned in two. The list is partitioned at the point where a potential swap between trains may induce a delay beyond the on-time threshold (i.e. $t_{Ot} = 6min$). Consequently, since swaps closer to the on-time threshold have a higher likelihood to generate entrance sequences that improve the current incumbent solution, they are reckoned as being 'elite'. For example, the difference in the scheduled arrival time $a_{T_{91,2}^1-T_{61,3}^2}$ between train $T_{91,2}^1$ and train $T_{61,3}^2$ computed through equation 10.7 with the information in table 14.9, is only 1 minute (elite swap).

The short-term list $L_{P_{I_{S,o}}}$ partitioned in two supports the selection of elite and non-elite swaps. The number of elite swaps to be selected for every iteration of the Tabu Search algorithm is established by means of equation 10.10. From equation 10.10, a total of 4 to 3 slots in the short-term list are recommended to be reserved for elite swaps in cases where less than 30 queuing trains are being handled (as is the case for side 1).

As a result, if the short-term list accommodates 4 elite swaps, the remaining 3 slots in the list (for a total of 7 – see the previous subtitle) are reserved for non-elite swaps.

The remaining 6 steps in the Tabu Search algorithm, foresee the exploration of the search space. Where random swaps from the two partitioned list of possible swaps $L_{CW_{I_{1,1}}}$ are selected to generate new entrance sequences u that are transferred as constraints to the CDCR process during the fixing of the PVSCS combination (see section 11).

Once, the termination criteria of the Tabu Search algorithm is met (see subsection 10.5.5), the fitness of the fixed PVSCS combination for an assessed sequence u is delivered to the Genetic algorithm (see figure 10.4).

14.6.3. Combination of the PVSCS – Genetic Algorithm

Once the initial PVSCS combination $I_{s,o=1}$ has been established, fixed (considering the entrance sequence of potential queuing trains to the LtfTS), and assessed, it provides with the upper bound to continue the assembly of further PVSCS combinations by means of the Genetic algorithm.

The Genetic algorithm supports the systematic assembly of PVSCS combinations through the eight steps detailed in subsection 10.6.

Aligned with previous subtitles and subsections, the Genetic algorithm is implemented for the assembly of PVSCS combinations on side 1 of the investigated scenario.

The first two steps of the Genetic algorithm utilize the fitness of the initial PVSCS combination, as the upper bound, for the systematic assembly of the PVSCS combinations. A total of F PVSCS combinations are assembled, constituting the initial population of the Genetic algorithm.

The size of the initial population F , namely, the number of PVSCS combinations that need to be assembled to constitute the first generation of the Genetic algorithm, is ascertained as detailed in equation 10.12.

$$F = 2 * 33 = 66$$

Replacing the total number of trains circulating on side 1 of the disruption divided network (i.e. 33 trains – see table 14.7), a total of 66 PVSCS combinations must be assembled.

The 66 PVSCS combinations are assembled following the seven-step process detailed in subsection 10.6.1. The assembly is similar to the process behind the establishment of the initial combination. The only difference is that in this case, a random selection of specific PVSCS is supported instead of selecting the first PVSCS in each train's PVSCS set. Nonetheless, the operational compatibility of every PVSCS in the combination still needs to be verified every time a new PVSCS is introduced in the combination. Once the PVSCS combinations are assembled, they must be made conflict-free through the vehicle-specific CDCR process and subsequently assessed, as detailed respectively in sections 11 and 12. It must be noted that the PVSCS assembly process must be conducted in parallel for both sides of the disruption divided network.

The following six steps are characteristic for a Genetic algorithm, namely, selection of members in the population (i.e. PVSCS combinations) to establish the “mating” pairs, crossover, mutation, and the establishment of the new generation.

The selection of PVSCS combinations from the investigated generation so as to establish the “mating” pairs is conducted through the tournament selection process detailed in subsection 10.6.2. Later, between every “mated” pair of PVSCS combinations, specific PVSCS are randomly exchanged (i.e. crossover), resulting in two new PVSCS combinations (i.e. offspring). For example, if the PVSCS combination $I_{1,1}$ (handled in the two previous subsections) is paired with a fictitious PVSCS combination $I_{1,61}$, only by exchanging the PVSCS of train $T_{5,1}$ in PVSCS combination $I_{1,1}$ (i.e. $d_{T_{5,1}}$) with the PVSCS of train $T_{5,1}$ in PVSCS combination $I_{1,66}$ (e.g. $e_{T_{5,1}}$), two new combinations may be generated. The resulting PVSCS combinations are verified to ensure they are operationally compatible (see subsection 10.4.2). If the resulting PVSCS combinations are not operationally compatible, a mutation process foresees the selection of another PVSCS from the train's set of PVSCS, as discussed in subsection 10.6.3. Thereafter, the two new and operationally compatible PVSCS combinations are introduced in the Tabu Search (if necessary), fixed and

assessed to ascertain their fitness. Finally, from the four resulting PVSCS combinations (i.e. the two originally paired combinations and the two offspring), the two with the best fitness are transferred to the new generation.

The last six steps are conducted until a new generation containing F PVSCS combinations is generated. The algorithm circles back to the establishment of the “mating” pairs until the termination criteria detailed in subsection 10.6.4 are fulfilled.

14.7. Vehicle-specific CDCR Process

As outlined in figure 3.1, the next step in the system foresees the implementation of the CDCR process on every assembled PVSCS combination. The CDCR process detailed in section 11 is conducted exclusively at the vehicle-specific level and supports the identification of conflicts as well as the development of conflict resolution alternatives for a spatiotemporal transformation of the PVSCS combinations towards attaining a conflict-free schedule. This subsection exemplifies the implementation of the structured approach guiding the vehicle-specific CDCR process displayed in figure 11.1.

Aligned with previous subsections, this subsection continues to extend the example on side 1 of the disruption divided network. In the following subsection 14.7.1, the identification of all four vehicle-specific conflict types, namely, occupancy, infrastructure availability, circulation, and service conflicts, is exemplified (see subsection 11.4). Later, subsection 14.7.2 provides an example of the development of conflict resolution alternatives for some of the conflicts identified in subsection 14.7.1 (see subsection 11.5). Both the identification and resolution of conflicts are advanced mainly for cases within the critical area of the network, as it is in this location that the full capability of the system can be better exemplified. Finally, based on one of the conflicts identified in subsection 11.7.1 and its conflict resolution alternatives developed in subsection 11.7.2, subsection 14.7.3 provides an example of the establishment of the conflict severity and the identification of follow-up conflicts (see subsections 11.5.5 and 11.4.1 respectively).

14.7.1. Conflict Identification

As established in the structured approach, the module starts with the identification of all four vehicle-specific conflict types, namely, occupancy, infrastructure availability, circulation and service conflicts. In subsection 11.4, specific approaches for the identification of each of the vehicle-specific conflict types have been introduced.

The identification of occupancy, infrastructure availability, circulation and service conflicts is exemplified in the following subtitles.

Identification of Occupancy Conflicts

As discussed in subsection 11.4.1, the identification of occupancy conflicts is conducted separately for conflicts in links and nodes.

To support the identification of occupancy conflicts, a portion of the infrastructure between stations Frankfurt Messe (i.e. FFME) and the Frankfurt Hbf (Tief) (i.e. FFT) including Frankfurt Galluswarte is introduced in figure 14.9. The infrastructure represented in figure 14.9 is aligned with the infrastructure modelling technique utilized in the system (see subsection 5.1.1).

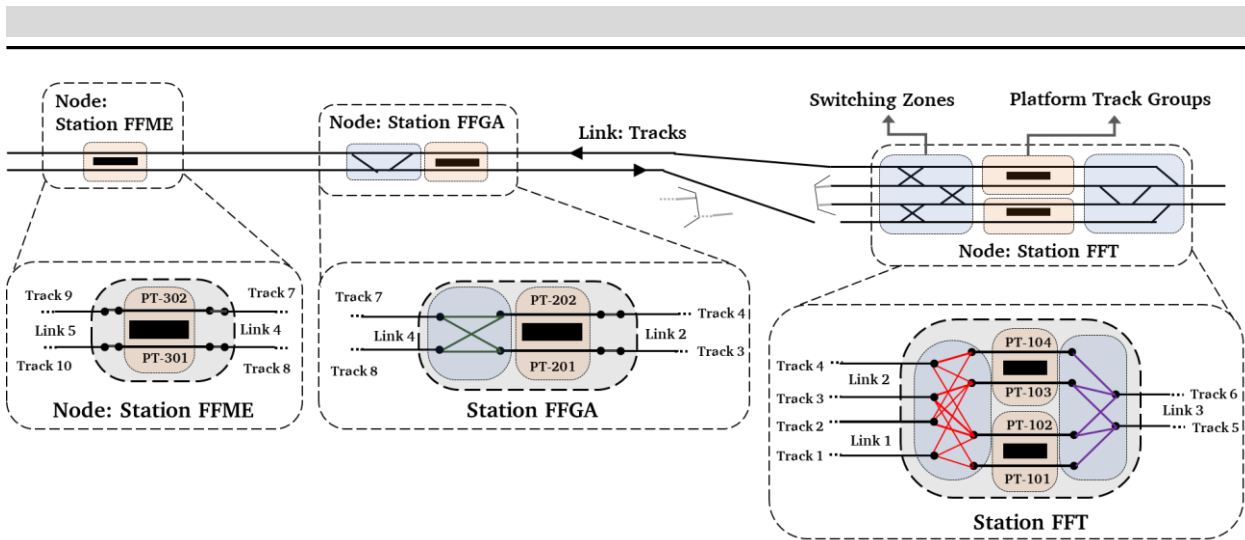

Figure 14.9 Infrastructure model between stations Frankfurt Messe (FFME) and Frankfurt Hbf –Tief (FFT), including Frankfurt Galluswarte (FFGA) (by author)

Identification of Occupancy Conflicts in Links

The identification of conflicts in lines within the critical area can be exemplified by observing figure 14.10. Figure 14.10 focuses on three train services on side 1 of the disruption, namely, train service S35437, S95946, and S95948. Additionally, information regarding the delay carried by each train (i.e. grey box), and a transition between train services S35437 and S35436 are also depicted.

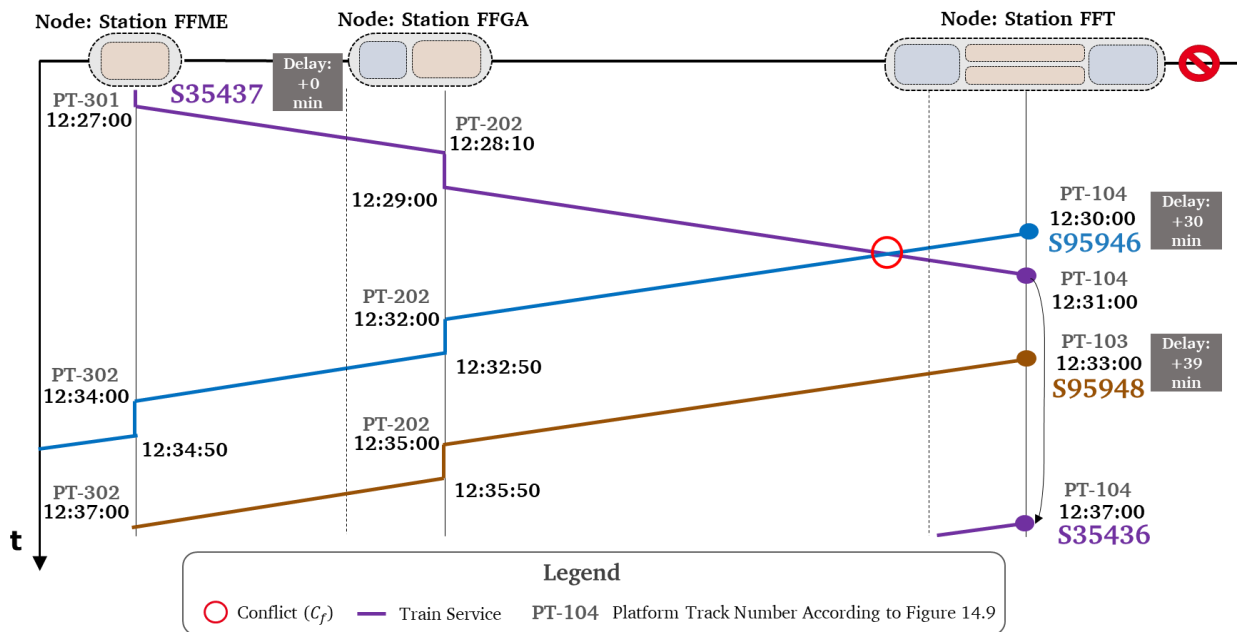

Figure 14.10 General example of an occupancy conflict in a link within the critical area (by author)

Occupancy conflicts in links are identified through equation 11.1. The information regarding the identification of occupancy conflicts between the trains depicted in figure 14.10 and between stations FFT and FFGA, is summarized in table 14.10.

Table 14.10 Example of the identification of occupancy conflicts in links (by author)

Train Pair		Departure time			Δ Departure (Eqq. 11.1)	Min Headway Time		Conflict (Eqq. 11.1)
		Station	Time	Source		Value (approx)	Source	
T1	S35437	FFGA	12:29 pm	Schedule	1 min	3 min	Eqq. 2.2 + Schedule	Yes
T2	S95946	FFT	12:30 pm	Traffic Diagram				
T1	S35437	FFGA	12:29 pm	Schedule	4 min	3 min	Eqq. 2.2 + Schedule	No
T2	S95948	FFT	12:33 pm	Traffic Diagram				

Since train service S35437 approaches the station FFT utilizing the track in the opposite direction (i.e. track 4 – see figure 14.9), an occupancy conflict between train service S35437 and train service S95946 in link 2, is identified.

Furthermore, as discussed in subsection 11.4.1, the temporal occurrence t_{C_f} of the conflict is registered as the earliest projected departure among the conflict partners from the nodes adjacent to de investigated link; thus, $t_{C_f} = 12:29$.

Identification of Occupancy Conflicts in Nodes

The identification of occupancy conflicts in nodes can also be ascertained by utilizing the case of train services S35437, S95946 and S95948 and focusing on station FFGA.

Initially, the matrix of occupations (matrix Z) and matrix of conflicts (Matrix K) for the different driving patterns through the station FFGA should be obtained from the infrastructure model. The total occupancy times for the different driving patterns and model trains detailed the matrix of occupations (matrix Z) is central for the identification of potential occupancy conflicts in the switching areas and the platform tracks (see subsection 11.4.1).

Based on the movement of trains depicted in figure 14.10, a potential conflict between train S35437 and train S95946 within the station FFGA may be exemplified. Since train S35437 changes its route utilizing the switching zone in FFGA, a potential occupancy conflict can be identified for a parallel departure of train S95946 from FFGA and arrival of train service S95946 to FFGA.

To ascertain the conflicting route, the infrastructure model depicted in figure 14.9 is utilized. Train service S35437 utilizes the route through the switching zone linking track 8 with platform track PT-202 as it arrives at FFGA. On the other hand, train service S95946 departs from FFGA utilizing the route through the switching zone linking the platform track PT-202 and track 7. If the total occupancy time for a departing train (after a stop) from platform track PT-202 towards track 7 followed by the arrival of a train from track 8 towards platform track PT-202 with a scheduled stop in the station is: $t_{Z_{K\omega_{Galluswarte}}^{MT_i-MT_j}} = 1 \text{ minute}$, a conflict in the switching zone is ascertained by means of equation 11.2.

$$t_{Proj.Dep}^{Galluswarte S95946} + t_{Z_{K\omega_{Galluswarte}}^{MT_i-MT_j}} > t_{Proj.Arr}^{Galluswarte S35437}$$

$$12:32:50 + 1 \text{ min} > t_{Proj.Arr}^{Galluswarte S35437} \rightarrow 12:33:50 > t_{Proj.Arr}^{Galluswarte S35437}$$

An occupancy conflict between trains is identified if equation 11.2 is fulfilled (see subsection 11.4.1). Therefore, an occupancy conflict in switching area of FFGA for a departure of train S95946 and the subsequent arrival of train S35437 is identified, for any potential arrival of train S35437 between 12:32:00 pm and 12:33:50 pm.

The temporal occurrence t_{c_f} of the conflict is registered as the earliest projected departure or arrival time among the conflict partners, from the investigated node.

Identification of Infrastructure Availability Conflicts

In the dynamic DRP deployment system, infrastructure availability conflicts are identified due to two general reasons. On the one hand, infrastructural elements or certain of its attributes may not be available to support the movements of trains. On the other hand, the entrance sequence of potentially queuing trains to the LtfTS, which has been imposed by the Tabu Search, must be respected.

An example of infrastructure availability conflicts product of the unavailability of infrastructural elements has been provided in subsection 5.1.1 through figure 5.2.

An example of infrastructure availability conflicts product of the entrance sequence of potentially queuing trains can be advanced utilizing the information in table 14.9. Table 14.9 provides with an initial entrance sequence (i.e. FCFS) of potential queuing trains to the LtfTS for a factious initial PVSCS combination on side 1 of the disruption divided network.

According to table 14.9, the initial entrance sequence u of 13 potential queuing trains $T_{l_s,i}^h$ to the LtfTS is: $u = \{ T_{9,2}^1, T_{6,3}^2, T_{4,4}^3, T_{8,10}^4, T_{3,12}^5, T_{9,16}^6, T_{4,17}^7, T_{8,20}^8, T_{3,25}^9, T_{9,22}^{10}, T_{8,27}^{11}, T_{9,29}^{12}, T_{8,33}^{13} \}$. As discussed in subsection 11.4.1, a conflict is identified if the entrance sequence under investigation derived from the Tabu Search algorithm u does not match the sequence of projected arrivals to the LtfTS π (see subsection 11.4.1).

If train service S35933 (i.e. $T_{9,2}$ – see table 14.9), which is scheduled to arrive at the LtfTS at 11:59 pm (see table 14.9), is delayed for more than 2 minutes (i.e. 12:01 pm), the sequence of projected arrivals π would need to be adjusted. The sequence of projected arrival is adjusted to support the delayed arrival of train $T_{9,2}$ to the LtfTS (under the assumption that train service S35933 is the only delayed train) as follows:

$$\pi = \{ T_{6,3}^2, T_{9,2}^1, T_{4,4}^3, T_{8,10}^4, T_{3,12}^5, T_{9,16}^6, T_{4,17}^7, T_{8,20}^8, T_{3,25}^9, T_{9,22}^{10}, T_{8,27}^{11}, T_{9,29}^{12}, T_{8,33}^{13} \}.$$

Since the arrival of train $T_{6,3}^2$ at the LtfTS is projected for 12:00 pm (see table 14.9), the adjusted sequence π exchanges the order between the delayed train $T_{9,2}^1$ and train $T_{6,3}^2$.

Since the entrance sequence under investigation u and the resulting sequence of projected arrivals π are not identical, a conflict is identified. From the sequence, only one conflicting train is identified, namely train $T_{6,3}^2$, which would have all the infrastructural elements in the LtfTS unavailable until train $T_{9,2}^1$ reaches its platform track. The temporal occurrence t_{c_f} of the conflict is registered equal to the projected arrival time of the conflicting train (i.e. $T_{6,3}^2$) to the LtfTS (i.e. $t_{c_f} = 12:00$).

Identification of Circulation Conflicts

As discussed in subsection 11.4.1, three kinds of circulation conflicts can be identified. The first kind concentrates on the scheduled transitions between train services, which do not support the minimum transition time. The second kind focuses on train services foreseen in the DRP operating program of a line that have not been appointed with a vehicle composition in the investigated

PVSCS combination. The third kind, which is only identified within the critical area, takes into consideration trains that must wait in the platform track until their scheduled departure time.

The information utilized during the development and verification of the PVSCS of train service S36525 (i.e. $T_{5,1}$) discussed in subsections 14.5.3 and 14.5.4, is utilized to exemplify the identification of the first kind of circulation conflict. If train service S35534 is projected to arrive at its end station the furthest from the disrupted section at 12:31 pm (already delayed 11 minutes - see subsection 14.5.4) and its transition train service (i.e. train service S35539) is scheduled to depart from the station (in the opposite direction) at 12:38 pm, a potential circulation conflict may be identified. According to the approach introduced in subsection 11.4.1, a circulation conflict is identified if the equation is satisfied.

$$t_{Sch.Dep}^{Friedrichsdorf} S35539 - t_{Proj.Arr}^{Friedrichsdorf} S35534 < \min t_{Trans}$$

$$12:38 - 12:31 < 6 \text{ min} \rightarrow 7 \text{ min} < 6 \text{ min}$$

Once the respective values are introduced in equation 11.4, no circulation conflict is identified. However, in case train service S35534 is delayed for an additional 3 minutes, equation 11.4 would be satisfied, and a circulation conflict would be identified. In this case, the temporal occurrence t_{C_f} of the conflict is registered equal to the scheduled departure time of the transition train service from the station (i.e. $t_{C_f} = 12:38$).

Furthermore, the identification of circulation conflicts where no vehicle composition has been assigned to a train service can be exemplified by observing the case of line S3 on side 1 of the disruption divided network. As detailed in table 14.4, line S3 on side 1 has a lack of one vehicle or vehicle composition to support all the services foreseen in its DRP operating program. Therefore, if no replacement vehicle resources (e.g. at the different parking locations, from a corresponding line, from a transfer, etc.) are available, the cancellation of train services for line S3 on side 1 would be imminent.

Finally, the identification of circulation conflicts in cases, where a positive turn at the LtFTS has been generated, is exemplified. For the example a transition of train $T_{5,1}$ (i.e. train service S36525) to the last train service in its range of potential transition train services (i.e. train service S36536 – see subsection 14.5.2) at the LtFTS is assessed. To establish the constraints of the example, it is necessary to ascertain the projected arrival time of train S36525 to the station and the scheduled departure time of the transition train service from the LtFTS after the turn.

On the one hand, train service S36525 is already at the LtFTS the moment the system is being deployed (i.e. $t_{0,NVZ} = 11:59 \text{ pm}$). On the other hand, from the original schedule, it is possible to ascertain that train service S36536 is scheduled to depart at 12:24 pm from Frankfurt Hbf (Tief) in direction towards Friedrichsdorf. If the respective values are introduced in equation 11.5, a circulation conflict is identified, since the equation is not satisfied.

$$t_{Sch.Dep}^{Frankfurt Hbf (Tief)} S36536 - t_{Proj.Arr}^{Frankfurt Hbf (Tief)} S36525 = \min t_{Trans}$$

$$12:24 - 11:59 = 6 \text{ min} \rightarrow 25 \text{ min} \neq 6 \text{ min}$$

The temporal occurrence t_{C_f} of this conflict is derived from equation 11.6.

$$t_{C_f} = t_{Proj.Arr}^{Frankfurt Hbf (Tief)} S36525 + \min t_{Trans}$$

$$t_{C_f} = 11:59 + 6 \text{ min} = 12:05$$

From the analysis it is possible to appreciate how train $T_{5,1}$ would need to wait at its platform track for an additional 19 minutes after completing its transition (i.e. supporting the minimum transition time for a turn) before it can depart from the LtfTS.

Identification of Service Conflicts

As discussed in subsection 11.4.1, service conflicts are identified if the cancellation of a train service generates a service interval greater than the maximum service interval. The foundation to advance an example for the identification of service conflicts has already been introduced in subsection 6.3.13. The example presented in figure 6.1 is given temporal values to support the identification of the service conflicts, as detailed in subsection 11.4.1.

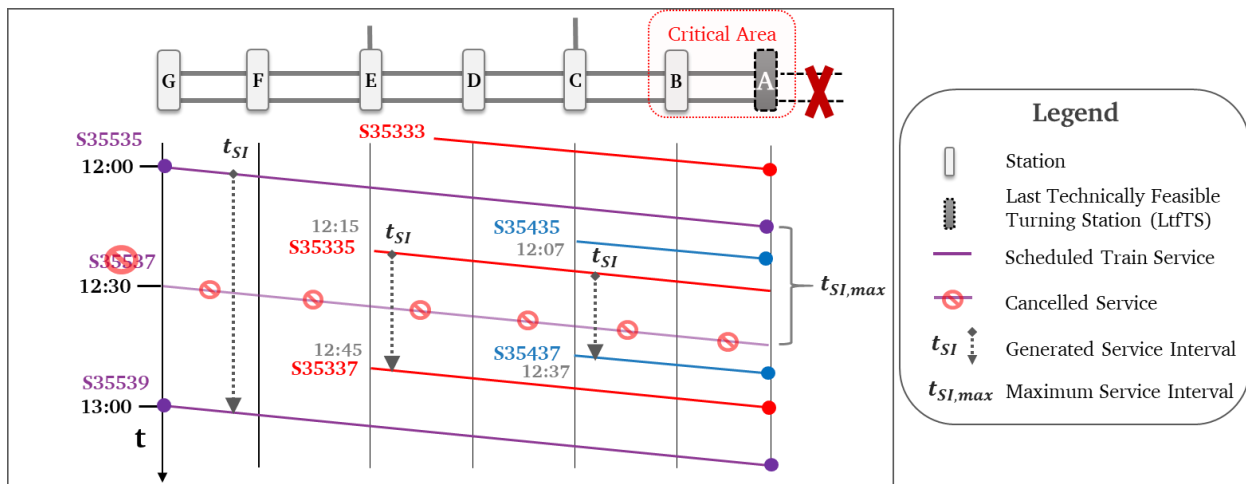

Figure 14.11 Example for the identification of service conflicts (by author)

From the PVSCS combination displayed in figure 14.11, it is assumed that train service S35537 has been totally cancelled due to a lack of vehicle availability resources. As it may be appreciated in the figure, the most considerable gap between train services after the cancellation of train service S35537 is generated in stations G and F. Therefore, from a passenger welfare perspective, stations G and F are the most affected.

The first step in the identification of service conflicts is the establishment of the generated service interval by ascertaining the prior and subsequent trains services that would reach an affected station as detailed in subsection 3.7.2. Focusing on station G, the prior and subsequent train services have been respectively identified as: train service S35535 and train service S35539. By introducing the departure times of the identified trains services from station G in equation 11.7 (see figure 14.11), the generated service interval $t_{SI_{S35537}}^G$ is ascertained.

$$t_{SI_{S35537}}^G = t_{Proj,Dep}^G_{S35535} - t_{Proj,Dep}^G_{S35539}$$

$$t_{SI_{S35537}}^G = 13:00 - 12:00 = 60 \text{ min}$$

Later, the maximum service interval must be established. As discussed in subsection 3.7.2, the maximum service interval is equal to the service interval for the line observed within the DRP operating concept (considering any cycle variant). In figure 14.11, it is possible to ascertain that the service interval within the DRP operating concept is equal to: $t_{SI,max_G} = 30 \text{ min}$.

As detailed in equation 11.9, if the generated service interval is larger than the maximum service interval, a service conflict is identified. By introducing the ascertained values in equation 11.9, a service conflict has been positively identified in station G.

$$t_{SI_{S35537}}^G > t_{SI,max_{S35537,DRP,5S,\psi}}$$

$$60 \text{ min} > 30 \text{ min}$$

From the temporal values provided for the train services in figure 14.11 and from the process executed within this subtitle, it is possible to conclude that a service conflict would also be identified in station F. However, since the generated service interval in stations E to A are, at most, as large the maximum service interval, no service conflict is identified.

The temporal occurrence t_{C_f} of the conflict is registered equal to the scheduled departure time of the cancelled train service from the first affected station (i.e. $t_{C_f} = 12:00$).

14.7.2. Development of Conflict Resolution Alternatives

As established in the structured approach displayed in figure 11.1, for every identified conflict regardless of the conflict type, different conflict resolution alternatives are developed. Subsection 11.5 introduces a series of approaches for the development of conflict resolution alternatives for each one of the vehicle-specific conflict types handled in the dynamic DRP deployment system. This subsection utilizes the conflicts identified in subsection 14.7.1 to exemplify the development of conflict resolution alternatives.

Since the conflict resolution portion of the CDCR process introduced in subsection 11.5 foresees the handling of conflicts within the critical area with much more detail, the implementation of the approaches focused in this area would permit to cover wider capabilities of the CDCR process. Consequently, examples featuring the implementation of the processes supporting the development of conflict resolution alternatives within the critical area are advanced in the following subtitles. The detailed examples solve: occupancy conflicts in links within the critical area, conflicting entrance sequences of potential queuing trains to the LtFTS, circulation conflicts with positive turns in the critical area, and service conflicts in general.

Development of Conflict Resolution Alternatives for Occupancy Conflicts

Development of Conflict Resolution Alternatives for Occupancy Conflicts in Links

The development of conflict resolution alternatives for occupancy conflicts in links within the critical area is advanced by means of the four steps detailed in subsection 11.5.1.

The four steps are implemented to solve the occupancy conflict identified between train service S35437 (i.e. T1) and train service S95946 (i.e. T2) (see table 14.10 – subsection 14.7.1) featured in figure 14.10. As a result, the following conflict resolution alternatives $RS_{C_f}^y$ are developed:

According to Step 1

- $RS_{C_f}^1$: Train service S95946 is shifted in time at its platform track in station FFT until the minimum headway time is respected. Consequently, a waiting time at the platform track in station FFT of: $t_w = 2 \text{ min}$ (equation 11.1) is introduced.

- $RS_{C_f}^2$: Train service S35437 is appointed a waiting time at the entrance of station FFGA. To establish the necessary waiting time, a conflict-free departure of train service S95946 from FFGA (only considering the conflict partners) should be taken under consideration, as discussed in subsection 11.5.1. Therefore, the arrival time of train service S35437 at the home signal before entering station FFGA (at the end of link 4 - see figure 14.9), including the change of its journey time due to a stop at this location, must be ascertained. To advance the example, it is assumed that train service S35437 would reach the home signal at 12:27:40 pm. Therefore, the waiting time introduced to train service S35437 at the home signal must be long enough to account for the departure of train service S95946 from station FFGA after a stop plus the time required to clear the conflicting route (i.e. $K_{\omega_{Galluswarte}}$ – see subsection 2.2.2). Utilizing the information from the identification of occupancy conflicts in nodes detailed in subsection 14.7.1, train service S35437 must be introduced a waiting time at the home signal before entering station FFGA of: $t_w = 12:33:50 - 12:27:40 = 6.17 \text{ min}$.
- The development of a conflict resolution alternative following remark ii) cannot be conducted as train service S95946 is located at the LtfTS (i.e. FFT), and its entrance to the FFT cannot be shifted in time (see subsection 11.5.1).

According to Step 2

- $RS_{C_f}^3$: Train service S35437 is shifted in time at the platform track in station FFGA until the minimum headway time is respected. Therefore, a waiting time aligned with a change of the order between the conflict partners should be assigned to train service S35437 at its platform track in station FFGA. The waiting time is computed for a minimum headway time equivalent to the change in the order of trains through the link. Therefore a waiting time of: $t_w = 3 \text{ min}$ (equation 11.1 and traffic diagram) is assigned to train service S35437 at the platform track of station FFGA.

According to Step 3

- $RS_{C_f}^4$: Train service S35437 is routed in station FFGA towards platform track PT-201 and track 3 (in link 2), which permits the train to reach platform track PT-102 at FFT.

No other alternatives are generated (i.e. towards PT-101 or PT-103 in FFT) as they would induce new occupancy conflicts at the platform track in station FFT (see subsection 11.5.1). It is assumed that platform track PT-101 is occupied by a train service, which is not depicted in figure 14.10.

According to Step 4

For the implementation of an EET, the following requirements must be fulfilled:

- e) The occupancy conflict must take place in a link previous to a LtfTS or between any of the turning stations within the critical area. (*Fulfilled*)
- f) If both conflict partners drive towards the LtfTS, the measure can only be applied to the latest partner in the two-train conflict. (*Not Applicable*)
- g) If the conflict partners drive in opposite directions, the measure can only be applied to the partner driving towards the LtfTS. (*Applicable – affected train service: S35437*)
- h) The waiting time t_w assigned to the train affected by the measure to solve the conflict (computed as in step 1 or 3), must be larger than the minimum turning time $\min t_{Turn}$.

The waiting time ascertained within $RS_{C_f}^3$ (i.e. $t_w = 3min$) is smaller than the minimum turning time for one driver (i.e. $min t_{Turn} = 6min$). (Not Fulfilled)

Since requirement d) cannot be fulfilled, an early turn cannot be utilized as a measure to solve the conflict.

Overall, four different conflict resolution alternatives have been developed to solve the identified occupancy conflict.

Development of Conflict Resolution Alternatives for Infrastructure Availability Conflicts

In order to develop different conflict resolution alternatives to address the conflicting entrance sequence, a three-step process is detailed in subsection 11.5.2.

The three steps are implemented for developing the conflict resolution alternatives to resolve the conflicting entrance sequence of train service S35633 (i.e. $T_{61,3}^2$) to the LtfTS. Since train S35633 (i.e. $T_{61,3}^2$) is projected to arrive at the LtfTS before train service S35933 (i.e. $T_{91,2}^1$), the entrance sequence imposed by the Tabu Search is not being respected (see subsection 14.7.1).

The minimum time the entrance of the conflicting train (i.e. $T_{61,3}^2$) to the LtfTS needs to be postponed is calculated as detailed in equation 11.11.

$$t_{Proj.Arr}^{LtfTS} T_{91,2}^1 - t_{Proj.Arr}^{LtfTS} T_{61,3}^2 = t_w^{LtfTS} T_{61,3}^2$$

$$12:01 - 12:00 = 1 min = t_w^{LtfTS} T_{61,3}^2$$

As a result, train service S35633 needs to be delayed for at least one minute in order to abide with the entrance sequence. The moment the system is being implemented, the actual location of train service S35633 (i.e. $T_{61,3}^2$) is considered to be between the train station FFGA and FFT (see figure 14.2). As a result, the following conflict resolution alternatives $RS_{C_f}^y$ are developed:

According to Step 1

- $RS_{C_f}^1$: Train $T_{61,3}^2$ is shifted in time at the entrance to FFT so that its projected arrival time to the LtfTS is postponed. Consequently, as ascertained by $t_w^{LtfTS} T_{61,3}^2$, a waiting time of less than one minute (i.e. $t_w = 1min - \Delta t_f$) to account for the change in the train's journey time due to the unforeseen stop at the home signal before entering the station FFT (at the end of link 2 - see figure 14.9) is assigned to train $T_{61,3}^2$.

According to Step 2

Given the actual location of the train (i.e. between train station FFGA and FFT), the development of conflict resolution alternatives that foresees the rerouting of train $T_{61,3}^2$ would produce no benefit for solving the conflict.

According to Step 3

Given the actual location of the train (i.e. between train station FFGA and FFT), the development of conflict resolution alternatives that foresees the early turn of train $T_{61,3}^2$ is not possible.

Overall, only one conflict resolution alternative has been developed to solve the identified conflict.

Development of Conflict Resolution Alternatives for Circulation Conflicts

The development of conflict resolution alternatives to solve circulation conflicts within the critical area is advanced by means of the five steps detailed in subsection 11.5.3.

The five steps detailed in subsection 11.5.3 are implemented to solve the circulation conflict identified for a transition (i.e. turning) between train service S36525 towards train service S36536 at the LtfTS (see subsection 14.7.1). Since the circulation conflict fulfills the relation detailed in equation 11.12, namely, a positive turn in the LtfTS has been identified, only step number six may be implemented to develop the conflict resolution alternatives to solve the conflict (see subsection 11.5.3).

$$t_{Sched.Dep}^{LtfTS_{S36536}} - t_{Proj.Arr}^{LtfTS_{S36525}} > \min t_{Turn}$$

$$12:24 - 11:59 > 6 \text{ min} \rightarrow 25 \text{ min}$$

As a result, the following conflict resolution alternatives RS_{Cf}^y are developed:

According to Step 5

Step five foresees the development of an alternative train service, which permits to remove the train from the critical area before its scheduled departure time. The implementation of the measure is conducted following three steps:

1. A special train number must be selected for the development of the alternative train service. For the development of the example, a train service number *ATS2406* is chosen to recognize the alternative train service.
2. The starting node and the portion of the train's PVSCS that is to be shifted negatively in time need to be established. The negative shift is conducted while supporting the minimum transition time.

In the case of a transition between train service S36525 to train service S36536, the PVSCS of train S36536 is shifted negatively in time a total of 19 minutes (see subsection 14.7.1) between FFT and FFME. As a result, table 14.11 approximates the departure and arrival times detailed in the PVSCS of the affected train service and the negative shift within the affected portion of the route.

Table 14.11 Example of a negative shift in time to support the early removal of a train from the LtfTS (by author)

		Departure/Arrival Times for Affected Stations				Source
		FFT	FFGA		FFME	
Train Service		Departure	Arrival	Departure	Arrival	
	S36536	12:24	12:26	12:27	12:28	Schedule
	ATS2406	12:05	12:07	12:08	12:09	Neg. Shift (-19 min)

The information provided in table 14.11, constitutes the temporal baseline for the development of the alternative train service.

Spatially, the baseline is constituted by the route train service S36536 had detailed in its PVSCS. Utilizing figure 14.9 as a reference, the route of the affected train service throughout the negative shifted portion of its PVSCS may be clarified. The affected train service starts at station FFT in platform track PT-101 and exits the station towards track 3 (opposite driving direction) reaching platform track PT-201 in station FFGA. Later, the

train would exit FFGA from platform track PT-201 towards track 7 in direction to station FFME.

3. With both the temporal and spatial baselines, an exploration of different routing alternatives is conducted. As it can be observed in figure 14.9, there are no other routing options that allow the train to reach FFGA from FFT platform track PT-101. Therefore, the only routing option that can be assessed is the one described in the train's original PVSCS, already detailed in step 2 (see subsection 11.5.3).

At the same time, the necessary temporal adjustments (i.e. STT) for the investigated train throughout the routing alternatives are ascertained so as to ensure that its movement aligns with the current operating situation. Detailed by the approach, the arrival of further trains to the LtfTS (i.e. station FFT) must be appreciated. According to table 14.9 within the time the train is projected to leave the station (i.e. 12:05 – see table 14.11), the following trains seek to access the LtfTS through the same link: $T_{6,1,3}$, $T_{4,1,4}$ and $T_{5,1,7}$. By considering the arrival time of other trains at the LtfTS (see table 14.9), the position of the investigated train and the number of platform tracks at the FFT (see also figure 14.9), it is possible to see that the development of an alternative train service, which seeks to remove train S36536 from FFT through the track in the opposite direction towards station FFGA, has minimal opportunity to be developed before the alternative is dropped according to the approach detailed in 11.5.3. At this point in the exploration, an alternative is dropped once the projected departure time of the affected train from the starting node supporting a conflict-free departure of the train under investigation is the same or larger than in its original PVSCS.

On the other hand, if train service S36536 would have been located in a different platform track at FFT with access to track 4 (e.g. PT-102, see figure 10.9), the development of the alternative train service would have allowed train service S36536 to be effectively removed as train service *ATS2406* from FFT before time.

Development of Conflict Resolution Alternatives for Service Conflicts

The development of conflict resolution alternatives to solve service conflicts is advanced by means of the four consecutive steps detailed in subsection 11.5.4.

The four consecutive steps are implemented to solve the service conflicts identified due to the total cancellation of train service S35537 (see figure 14.11 in subsection 14.7.1). As a result, the following conflict resolution alternative $RS_{C_f}^1$ is developed:

1. The service conflicts across all affected stations are recognized: $\{t_{SI_{S35537}}^G, t_{SI_{S35537}}^F\}$
2. The involved train services in each affected station, namely, prior, subsequent and any previously linked train services, are incorporated. As depicted in figure 14.11, the same train services are involved in the service conflicts at the different affected stations, namely, stations G and F:
 - Prior train service: S35535
 - Subsequent train service: S35539
 - Previously linked train services: *No Services*
3. A link between the cancelled and subsequent train services at every affected station is established so as to keep track of the transference of the passengers' waiting times: $\overline{S35537 - S35539}$.

4. Finally, the passengers waiting time at each of the affected stations (i.e. G and F) is ascertained individually, as detailed in equation 11.13.

$$\begin{aligned}
 t_{Pw,S35537-S35539}^G &= t_{Proj,Dep}^G S35539 - \left(t_{Proj,Dep}^G S35535 + t_{SI,max_{DRP}} \right) + 0 \\
 t_{Pw,S35537-S35539}^G &= 13:00 - (12:00 + 30 \text{ min}) \rightarrow t_{Pw,S35537-S35539}^G = 30 \text{ min} \\
 t_{Pw,S35537-S35539}^F &= t_{Proj,Dep}^F S35539 - \left(t_{Proj,Dep}^F S35535 + t_{SI,max_{DRP}} \right) + 0 \\
 t_{Pw,S35537-S35539}^F &= 13:03 - (12:03 + 30 \text{ min}) \rightarrow t_{Pw,S35537-S35539}^F = 30 \text{ min}
 \end{aligned}$$

The resulting conflict resolution $RS_{C_f}^1$ foresees the transference of passengers' waiting time and the linkage between the cancelled and subsequent train services individually at each of the affected stations.

14.7.3. Establishment of the Conflict Severity and Identification of Follow-up Conflicts

As established in the structured approach displayed in figure 11.1, once the conflict resolution alternatives for the identified conflicts have been developed, the induced follow-up conflicts are also identified (see subsection 11.4.1). Subsequently, for a projected implementation of every conflict resolution alternative, the severity of every identified conflict in the system, including the identified follow-up conflicts (see subsection 11.4.1), must be established. In this way, the change in the operation situation before and after the implementation of a conflict resolution alternative can be ascertained. The conflict severity is established following the approaches detailed throughout subsection 11.5.5.

The occupancy conflict in a link within the critical area identified in subsection 14.7.1 between train service S35437 and train service S95946 is utilized to advance an example of the identification of follow-up conflicts and the establishment of the conflict severity. Furthermore, two of the conflict resolution alternatives developed in subsection 14.7.2 to solve the identified occupancy conflict; namely, conflict resolution alternative $RS_{C_f}^2$ and $RS_{C_f}^4$ are handled in the example.

Initially, the severity of the identified conflict is established. According to the approach detailed in subsection 11.5.5, the conflict severity is established through the development of “probable” conflict resolution alternatives $RS_{C_f}^{yse}$. The “probable” conflict resolution alternatives are later assessed and selected, as discussed in subsection 12.3.2. The approach detailed in subsection 11.5.5 foresees the development of the “probable” conflict resolution alternatives for occupancy conflicts in links only by shifting the conflict partners in time. Therefore, conflict resolution alternatives $RS_{C_f}^1$ and $RS_{C_f}^3$ (see subsection 14.7.2) may be immediately recognized as the set of “probable” conflict resolution alternatives; respectively, $RS_{C_f}^{1se}$ and $RS_{C_f}^{2se}$, to ascertain the severity of the investigated occupancy conflict between train service S35437 and train service S95946.

Subsequently, for every conflict resolution alternative that has been developed, the induced follow-up conflicts must be ascertained. The identification of follow-up conflicts induced by an implementation of conflict resolution alternative $RS_{C_f}^2$, is supported by figure 14.12. Figure 14.12, depicts the implementation of the conflict resolution alternative $RS_{C_f}^2$.

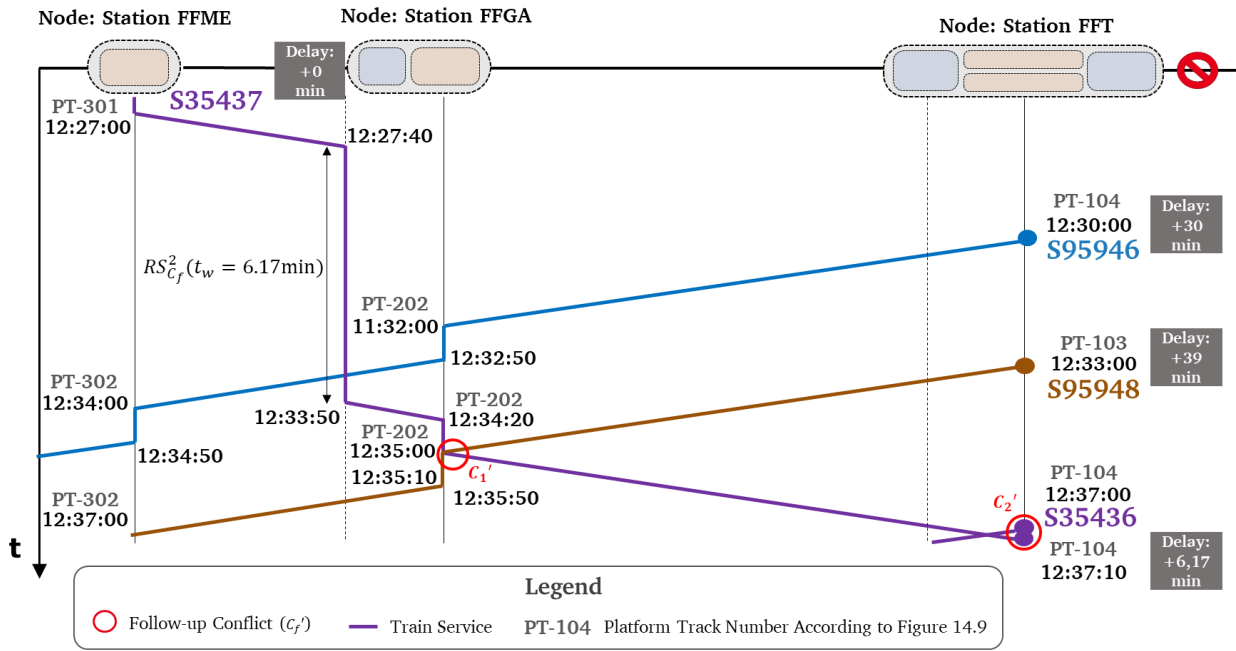

Figure 14.12 General example of an implementation of a conflict resolution alternative and identification of follow-up conflicts (by author)

As depicted in figure 14.12, two follow-up conflicts may be identified. On the one hand, an occupancy conflict in the platform track PT-202 between train services S35437 and S95948, and on the other hand, a circulation conflict between train services S35437 and S35436 at station FFT.

An occupancy conflict in the platform track is identified if equation 11.3 is satisfied. However, for the assessed driving pattern at platform track PT-202, the matrix of occupations (Matrix Z) in the infrastructure model would need to take into consideration the journey time through the whole link including the opposite node (i.e. link 2 and on track 4 and FFT) as that is the length of the whole conflicting route (since there is no switching zone – see figure 14.9). Therefore, it is assumed that the total occupancy time for a departing train (after a stop) from platform track PT-202 towards track 4 followed by a train starting from platform track PT-103 at FFT driving through track 4 towards platform track PT-202 with a scheduled stop in station FFGA is: $t_{Z_{MT_i-MT_j}}^{PT-102Galluswarte} = 4,17 \text{ minutes}$. By introducing the respective values in equation 11.3, an occupancy conflict in the platform track is PT-202 identified.

$$t_{Proj.dep}^{Galluswarte S95946} + t_{Z_{MT_i-MT_j}}^{PT-102Galluswarte} > t_{Proj.Arr}^{Galluswarte S35437}$$

$$12:35:10 + 4,17 \text{ min} > 12:35:00$$

As equation 11.3 is satisfied, a follow-up occupancy conflict in platform track PT-202 has been identified between train services S35437 and S95948. The temporal occurrence $t_{C_f'}$ of the first follow-up conflict (i.e. C_1') for an implementation of conflict resolution $RS_{C_f}^2$ is registered as the earliest projected departure time among the conflict partners from the investigated node (see subsection 11.4.1); thus, $t_{C_1'} = 12:35:00$.

A circulation conflict is identified if equation 11.4 is satisfied. By introducing the respective values for the transition between train services S35437 and S35436 at station FFT in equation 11.3, a circulation conflict is identified.

$$t_{Sched.Dep}^{Frankfurt Hbh (Tief) S35436} - t_{Proj.Arr}^{Frankfurt Hbh (Tief) S35437} < \min t_{Turn}$$

$$12:37:00 - 12:37:10 < 6 \text{ min} \rightarrow -00:00:10 < 6 \text{ min}$$

The temporal occurrence of the second follow-up conflict (i.e. C_2') for an implementation of conflict resolution $RS_{C_f}^2$ is registered as the scheduled departure time of the transition train service (i.e. S95948) from the investigated node; thus, $t_{C_2'} = 12:37:00$.

Furthermore, the identification of follow-up conflicts induced by conflict resolution alternative $RS_{C_f}^4$ must also be conducted. Nonetheless, since conflict resolution alternative $RS_{C_f}^4$ foresees the rerouting of train service S35437 through platform track PT-201 towards track 3 reaching platform track PT-102 in FFT, no follow-up conflicts are identified.

Finally, the severity of the follow-up conflicts (i.e. C_1' and C_2') identified for an implementation of conflict resolution alternative $RS_{C_f}^2$ must be established. Initially, as discussed in subsection 11.5.5, the severity of occupancy conflicts within nodes and as well as for circulation conflicts are established utilizing the shift in time and the rerouting of the trains involved in the conflict.

As a result, two “probable” conflict solution alternatives are established for conflict C_1' and one for conflict C_2' .

- $RS_{C_1'RS_{C_f}^2}^{1se}$: Train service S95948 is shifted in time at its platform track in station FFT until the minimum headway time is respected. Consequently, a waiting time at the platform track PT-103 in station FFT of $t_w = 4.33 \text{ min}$ (equation 11.1) is assigned.
- $RS_{C_1'RS_{C_f}^2}^{2se}$: Train service S35437 is routed in station FFT from its platform track PT-103 towards track 3 (in link 2) reaching platform track PT-201 in station FFGA (see figure 14.9).
- $RS_{C_2'RS_{C_f}^2}^{1se}$: Train service S35436 is shifted in time until the minimum transition time is respected. Therefore, the departure of the transition train service from FFT is shifted in time: $t_w = 6.17 \text{ min}$.

14.8. Assessment of Conflict Resolution Alternatives and Fixed PVSCS Combinations

As outlined in figure 3.1, the next step in the system foresees the systematic assessment of the conflict resolution alternatives developed in the CDCR process, and ultimately, establishing the fitness of every fixed (i.e. conflict-free) PVSCS combination. The assessment of the conflict resolution alternatives and the establishment of the fitness of the PVSCS combination is conducted separately, as detailed in section 12. This subsection provides an example for the implementation of the assessment of the conflict resolution alternatives and an overview of the processes behind the establishment of the fitness of a fixed (i.e. conflict-free) PVSCS combination.

This subsection continues to extend the example on side 1 of the disruption divided network. In the following subsection 14.8.1, the structured approach to assess the conflict resolution alternatives developed in the CDCR process is implemented (see subsection 14.7.2 and 14.7.3). Later, subsection 14.8.2 provides an overview of the establishment of the fitness of a conflict-free PVSCS combination (see subsection 12.4).

14.8.1. Assessment of Conflict Resolution Alternatives

As established in the structured approach depicted in figure 12.1, the module supports the assessment of the conflict resolution alternatives developed through the CDCR process during the fixing of the PVSCS combinations. The module utilizes four evaluation parameters to assess a conflict resolution alternative and obtain its fitness (see subsection 12.3). The fitness of the investigated conflict resolution alternative is expressed temporally and compared with the fitness of other conflict resolution alternatives developed to solve the same conflict (see subsection 12.2.2).

The occupancy conflict in a link within the critical area identified in subsection 14.7.1 between train service S35437 and train service S95946, is utilized to advance an example of the assessment of conflict resolution alternatives. The assessment is conducted on the two conflict resolution alternatives (i.e. $RS_{C_f}^1$ and $RS_{C_f}^4$), for which the follow-up conflicts and “probable” conflict resolution alternatives to establish the severity have already been identified (see subsection 14.7.2 and 14.7.3).

As detailed in the structured approach across both the CDCR and the assessment modules (see figures 11.1 and 12.1 respectively), the establishment of the conflict severity requires both of these modules. The development of a set of “probable” conflict resolution alternatives is conducted within the CDCR process, and the selection of one of the alternatives to establish the severity of the conflict is conducted in the assessment module. Before the assessment of the two conflict resolution alternatives (i.e. $RS_{C_f}^2$ and $RS_{C_f}^4$) is executed, the severity of the occupancy conflict and the respective follow-up conflicts is ascertained in the following subtitle.

Establishing the Conflict Severity

Establishing the severity of each of the identified conflicts entails assessing the “probable” conflict resolution alternatives and choosing the one with the best fitness (see subsection 12.3.2). The assessment of the conflict severity is conducted by considering three evaluation parameters; namely, expected relative-time changes (i.e. EP_1), changes in platform tracks (i.e. EP_3) and cancelled train services (i.e. EP_4).

The evaluation function detailed in equation 12.4 is implemented on the “probable” conflict resolution alternatives established for the occupancy conflict C_f and the two follow-up conflicts (i.e. C_1' and C_2') for an implementation of conflict resolution $RS_{C_f}^2$. The results are detailed in table 14.12, where the fitness for every assessed “probable” conflict resolution alternative is derived and detailing of each of the evolution parameters.

Table 14.12 Example of the assessment of “probable” conflict resolution alternatives for the establishment of the conflict severity (by author)

Evaluation Parameter		Occupancy Conflict C_f		Follow-up conflicts C_f' for an Implementation of $RS_{C_f}^2$			w_i	Source
		$RS_{C_f}^{1se}$	$RS_{C_f}^{2se}$	Conflict C_1'		Conflict C_2'		
		$RS_{C_f}^{1se}$	$RS_{C_f}^{2se}$	$RS_{C_1'RS_{C_f}^2}^{1se}$	$RS_{C_1'RS_{C_f}^2}^{2se}$	$RS_{C_2'RS_{C_f}^2}^{1se}$		
EP_1	$\Delta RT_{T_{1S,i}}$	2 min	/	/	/	/	1	Eqq. 12.4
	$\Delta RT_{Circuitation}$	2 min						Eqq. 12.8
EP_3	$t_{p,ExT_{1S,i}}^{PVs_a}$	0					1	Eqq. 12.28
EP_4	$t_{Pw,Q-R}^S$	0					1	Eqq. 12.29
Fitness		4 min	6 min	8.66 min	0.9 min*	6,17 min		

*According to the layout of station FFGA, the platform change only induces a change on the edge of the platform track, and a value of 0.9 min is assumed as the minimum platform exchange time for passengers.

According to subsection 12.3.2, the “probable” conflict resolution alternative with the best fitness would ultimately constitute the severity of the identified conflict SE_{C_f} or of the follow-up conflicts resulting from an implementation of the conflict resolution alternative $SE_{C_f'RS_{C_f}^2}$ under investigation.

With the support of the results presented in table 14.12, the severity of every handled conflict can be ascertained. The severity of the occupancy conflict in the link within the critical area identified in subsection 14.7.1 between train service S35437 and train service S95946 is: $SE_{C_f} = 4min$ (see table 14.12 and equation 12.5). Additionally, the severity of the first and second follow-up conflicts (i.e. C_1' and C_2') for an implementation of conflict resolution $RS_{C_f}^2$ are: $SE_{C_1'RS_{C_f}^2} = 0.9min$, and $SE_{C_2'RS_{C_f}^2} = 6,17min$ (see table 14.12 and equation 12.5).

Assessment of the Conflict Resolution Alternatives

In the previous subtitle, the conflict severity of the identified occupancy conflict C_f and the two follow-up conflicts (i.e. C_1' and C_2') product of the implementation of conflict resolution alternative $RS_{C_f}^2$ have been ascertained. This subtitle exemplifies the assessment of the two conflict resolution alternatives (i.e. $RS_{C_f}^2$ and $RS_{C_f}^4$) to solve the occupancy conflict in a link within the critical area between train services S35437 and S95946 (see figure 14.10).

Table 14.13 implements the structured approach detailed in figure 12.1 to determine the fitness of the two conflict resolution alternatives under investigation. The assessment is conducted by considering the three evaluation parameters introduced above and complemented by an evaluation of the changes in the projected operating situation (i.e. EP_2). The table details the assessment, implementing each of the four parameters detailed throughout subsection 12.3 on conflict resolution alternative $RS_{C_f}^2$, and displaying the resulting fitness for the two assessed conflict solution alternatives.

Table 14.13 Example of the assessment of conflict resolution alternatives (by author)

		Occupancy Conflict C_f			
Evaluation Parameter		$RS_{C_f}^2$	$RS_{C_f}^4$	w_i	Source
EP_1	$\Delta RT_{T_{LS,i}}$	6,17 min	/	1	Eqq. 12.4
	$\Delta RT_{Circualtion}$	6,17 min			Eqq. 12.8
EP_2	ΔOS	2,93min		1	Eqq. 12.13
EP_3	$t_{p.Ex-T_{LS,i}}^{P_{TSa}}$	0		1	Eqq. 12.28
EP_4	$t_{Pw,Q-R}^S$	0		1	Eqq. 12.29
Fitness		15.27 min		5,9 min	Eqq. 12.1

From table 14.13, it is possible to ascertain that conflict resolution alternative $RS_{C_f}^4$ constitutes the best alternative, as it has the minimum fitness value. Therefore, the occupancy conflict in the link within the critical area is resolved by rerouting of train service S35437 within station FFGA towards station FFT.

14.8.2. Ascertaining the Fitness of the PVSCS Combination

As the last step of the assessment of the conflict resolution alternatives, the partial fitness of every conflict resolution alternative is ascertained. By collecting the partial fitness of every selected conflict resolution alternative, the actual fitness of the PVSCS combination under investigation is established.

As discussed in subsection 12.4.1, the partial fitness of the already assessed conflict resolution alternative is ascertained by removing certain components within two of its evaluation parameters; namely, the assessed relative-time change on the train services linked by the circulation plan (i.e. $\Delta RT_{Circualtion}$) within EP_1 and the change in the projected operating situation (i.e. ΔOS) as a whole.

For example, if conflict resolution alternative $RS_{C_f}^2$ would have been selected to solve the occupancy conflict handled in the previous subsection, the partial fitness of the resolution alternative according to equation 12.41 would be:

$$R(RS_{C_f}^2) = 15.27 \text{ min} - (6.17 \text{ min} + 2.93 \text{ min}) = 6,17 \text{ min}$$

The partial fitness of all selected conflict resolution alternatives is added together to derive partial fitness of the conflict-free PVSCS combination under investigation $R(I_{S,o})'$ (see subsection 2.4.1). The partial fitness incorporates the weighted fitness of the two evaluation parameters that take into consideration the conflict-free PVSCS combination as detailed in equation 12.47; namely, changes in the turning station (i.e. EP_5) and the end-of-day imbalances (i.e. EP_6). As a result, the fitness of the conflict-free PVSCS combination under investigation $R(I_{S,o})$ is acquired and returned to the Tabu Search or Genetic algorithm.

14.9. Adjustment and Selection

As outlined in figure 3.1, the next step in the system foresees the adjustment of the conflict-free PVSCS combinations (i.e. schedules) and the selection of the solution, which is to be proposed by the dynamic DRP deployment system (see subsection 13.2). As discussed in subsection 13.3, the

adjustment of the conflict-free schedules consists of an identification and removal of unnecessary measures across every conflict resolution utilized to fix a given number of F' conflict-free PVSCS combinations in the converging population of the genetic algorithm (i.e. set δ_v - see subsection 13.2). This permits to enhance the fitness of the chosen conflict-free PVSCS combinations from the set δ_v and derive conflict-free PVSCS combinations with further quality and practical relevance. This subsection provides an example of the adjustment of a conflict-free PVSCS combination.

This subsection continues to extend the example on side 1 of the disruption divided network detailed in the scenario. In the following subsection 14.9.1, the structured approach to adjust the conflict conflict-free PVSCS combinations is implemented (see subsection 13.3).

14.9.1. Adjustment of the Conflict-free PVSCS Combination

The adjustment of the conflict-free PVSCS combinations (i.e. schedules), namely, the removal of the unnecessary measures, is advanced following similar principles as the vehicle-specific CDCR process introduced in section 11. The resulting structured approach detailed in subsection 13.3 foresees the identification, synchronous sorting and removal of the unnecessary measures (i.e. shifts in time, platform track changes, early turns and alternative train services) in the conflict-free PVSCS combinations.

The occupancy conflict in a link within the critical area between train service S35437 and train service S95946 (recognized as C_1 in figure 14.13), resolved through the measures developed in subsections 14.7.2 and 14.7.3, is utilized to advance an example of the adjustment of a conflict-free PVSCS combination. The resulting conflict-free PVSCS combination is depicted in figure 14.13, where five conflict resolutions RS_{C_f} have been implemented through the CDCR process.

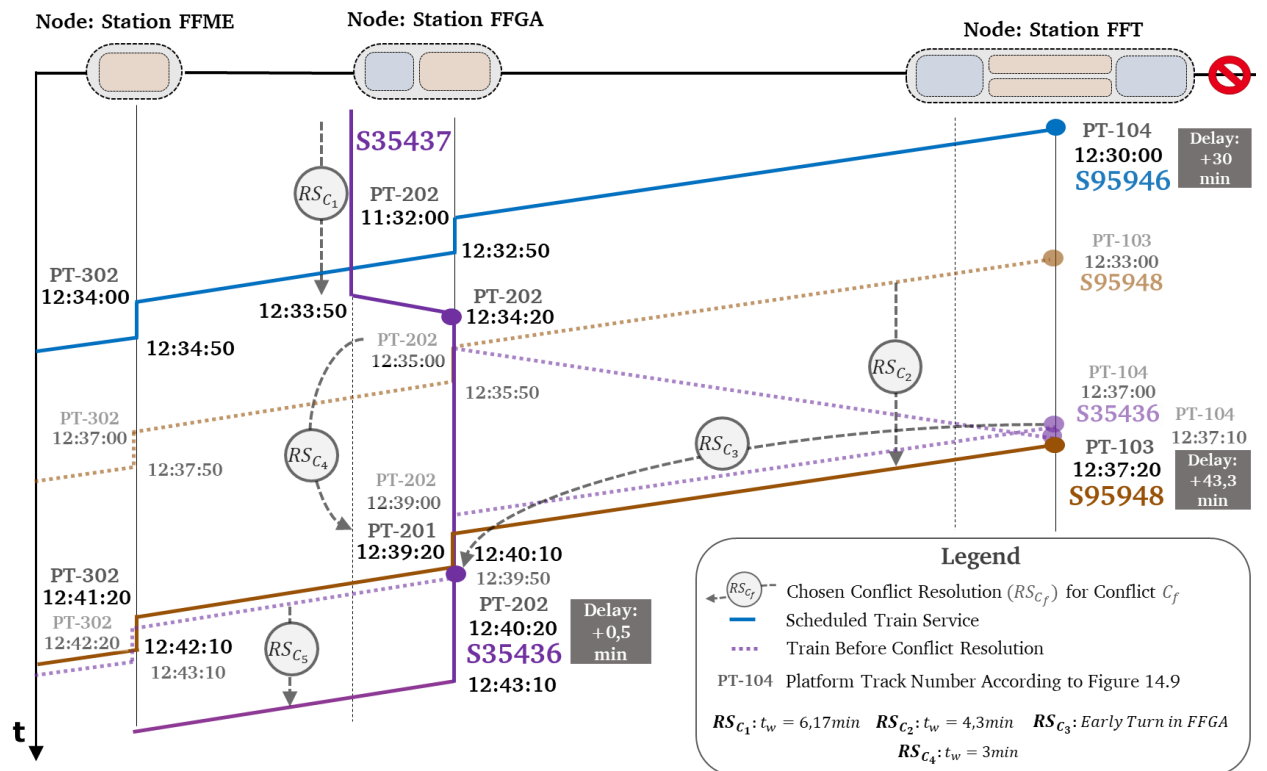

Figure 14.13 General example of a conflict-free PVSC combination with unnecessary measures (by author)

One of the conflict resolutions implemented to derive the conflict-free PVSCS combination utilized for the example was conflict resolution alternative $RS_{C_f}^4$ (recognized as RS_{C_1} in figure 14.13), which was detailed in subsection 14.7.3. Additionally, two other conflict resolution alternatives (recognized as RS_{C_2} and RS_{C_3} in figure 14.13) were implemented to solve the two follow-up conflicts, namely, C_1' and C_2' , which have been identified in subsection 14.7.3 (recognized as conflicts C_2 and C_3 in figure 14.13). Finally, two last conflict resolutions (recognized as RS_{C_4} and RS_{C_5} in figure 14.13) have been implemented to solve the follow-up conflict induced by the implementation of conflict resolution RS_{C_3} (i.e. early turn).

The elemental conflict solution measures utilized to develop each of the five conflict resolutions to fix the PVSCS combination shown in figure 14.13 are detailed in table 14.14. Table 14.14, recognizes the elemental conflict solutions within every conflict resolution that may be potentially identified as being unnecessary.

Table 14.14 Potentially unnecessary measures in a conflict resolution (by author)

Conflict Resolution RS_{C_f}	Shift in Time	Platform Track Changes	Early Turn	Alternative Schedule
RS_{C_1}	O	X	X	X
RS_{C_2}	O	X	X	X
RS_{C_3}	X	X	O	X
RS_{C_4}	X	O	X	X
RS_{C_5}	O	X	X	X

X: The conflict resolution displayed in figure 14.13 does not contain the measure

O: The conflict resolution displayed in figure 14.13 contains the measure

As detailed in the structured approach supporting the adjustment of a conflict-free PVSCS combination (see figure 13.2), the first step in the adjustment entails the identification of unnecessary measures (i.e. shifts in time, platform track changes, early turns and alternative train services). The unnecessary measures and their potential removal are identified while considering follow-up conflicts with third trains and the operating constraints. Later, the identified unnecessary measures are removed one by one in the order in which they have been identified. Finally, the positive fitness attained by removing the measure is determined.

An example of an adjusted schedule that incorporates the removal of unnecessary measures is displayed in figure 14.14. The figure portrays the removal of two measures that have been introduced by the conflict resolutions discussed in table 14.14. Therefore, figure 14.13 constitutes the initial situation of the adjusted schedule displayed in figure 14.14.

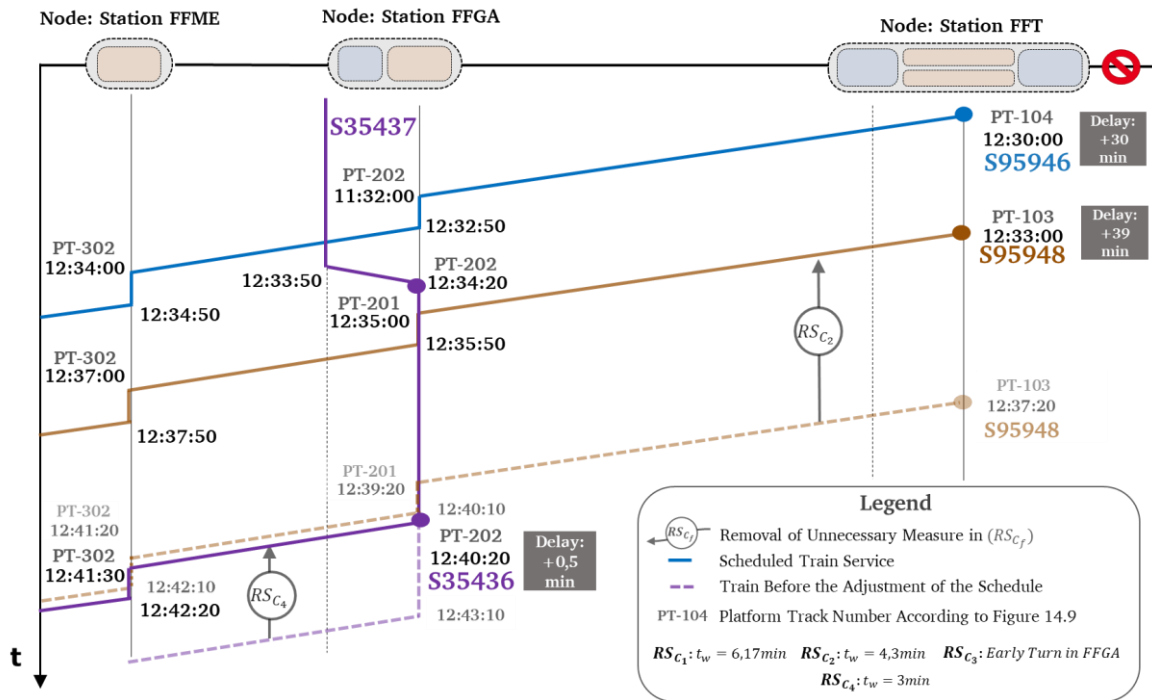

Figure 14.14 General example of the adjustment of conflict-free PVSC combination with unnecessary measures (by author)

The removal of the two unnecessary measures displayed in figure 14.14, following the approach detailed in figure 13.2, is detailed in the following paragraphs.

By implementing the approaches on the measures identified in table 14.14, the shift in time implemented on train service S95948 by conflict resolution RS_{C_2} is identified as being unnecessary. Applying equation 13.1 and 13.3 with the information displayed in figure 14.13, an unnecessary waiting time of: $t_{w,Adj_{T_{S,j}}} = 4,33 min$ is identified. By removing the waiting time a positive fitness of $NR(NC_f) = 4,33 min$ is acquired, which is ascertained through equation 13.4. If the partial fitness of all conflict resolutions utilized to address the induced follow-up conflicts generated by the removal of the unnecessary measure $NR(I_{S,o})'$ is smaller than the positive fitness $NR(NC_f)$, the conflict-free schedule obtained by removing the measure is maintained. In case of the example the partial fitness of all conflict resolutions utilized to address the induced follow-up conflicts $NR(I_{S,o})'$ should not be larger than 4.33 minutes.

If the shift in time due to measure RS_{C_2} is removed from the schedule, the list of unnecessary measures must be updated (see subsection 13.3.1). In the already adjusted conflict-free schedule, the shift in time implemented on train service S35436 introduced by conflict resolution RS_{C_5} is identified as being unnecessary. Applying equation 13.1 and 13.3 with the information displayed in figure 14.14, an unnecessary waiting time of: $t_{w,Adj_{T_{S,j}}} = 2,83 min$ is identified. In this case, upholding the minimum transition time foreseen for the affected train service at station FFGA is the decisive factor. Finally, as with the previous unnecessary measure, if the positive fitness (i.e. $NR(NC_f) = 2,83 min$) gained by removing the measure should be larger by the partial fitness $NR(I_{S,o})'$ required to solve all the induced follow-up conflicts generated by the removal of the unnecessary measure.

As discussed in subsection 13.2, gathering the differential in fitness (i.e. $NR(I_{S,o})' - NR(NC_f)$) across all unnecessary measures effectively removed from a conflict-free PVSCS combination $I_{S,o}$ (i.e. schedule), the adjusted fitness of the resulting adjusted schedule can be ascertained (see figure 13.2). Ultimately, by choosing from F' the adjusted schedule with the minimum adjusted fitness, a solution for the deployment of the chosen DRP to the actual disruption can be provided. The solution would be a train number and minute-specific (which comprises an accuracy of seconds) conflict-free schedule, similar to the one depicted in figure 14.14.

14.10. Summary

In this section, an exemplary implementation and application of the method supporting a dynamic DRP deployment to an actual disruption were introduced. Every single one of the modules that constitute the proposed system within was implemented utilizing a practical example detailed in subsection 14.2.

During the handling of the actual disruption, the information gathered and processed between subsections 14.3 and 14.5 permitted to establish different handling alternatives at the line-specific level for the trains circulating in the disrupted system — the established alternatives were later combined and refined at the vehicle-specific level. In consequence, the practical example permitted to observe the relevance of dividing the DRP deployment problem into two different operational levels, namely, line-specific and vehicle-specific, as foreseen by the system's method (see subsection 3.5.2).

At the line-specific operational level, the example was conducted considering the operating situation of the whole network, but paying particular attention to one side of the disruption divided network (side 1 – see figure 14.3). Additionally, for most of the processes at this level, an overview of the handling of a partial blockage was also provided. For the handled scenario and supported by the line-specific modules of the system (see subsection 3.5.3), the development of PVSCS for trains as different handling alternatives to address the disruption for the entire line has been exemplified.

At the vehicle-specific operational level, the example was conducted for train interactions in the critical area of the network and where the identification and resolution of conflicts have particular relevance for the transition to stable operations. The exemplified resolution of conflicts through the proposed approaches and predefined elemental conflict solution measures has been developed considering different alternatives. The alternatives have been assessed and selected utilizing the assessment framework specially tailored for the system. Finally, the importance behind the adjustment of the conflict-free schedules (derived from the proposed CDCR process) to improve their quality and further expand their practical relevance, has been demonstrated through the example.

The operating situation depicted in figure 14.14 after the adjustment of the schedule provides an overview of the train number and minute-specific (which comprises an accuracy of seconds) conflict-free schedule that can be attained through the implementation of the system proposed in this work.

15. Summary and Conclusions

15.1. Summary

The specific objective of the second *Section* of this work (see subsection 3.2.2) is to design a system that supports the dynamic deployment of existing DRP operating concepts on the actual operating situation (e.g. time of day, the actual location of the trains). The system should deploy a chosen line-specific DRP operating concept on the actual operating situation of a disrupted railway network (e.g. time of day, the actual location of the trains) and generate a train number and minute-specific conflict-free schedule. The resulting schedule ought to be of sufficient quality for its practical implementation, and in particular, ensure that the network transitions to stable operations. This entailed that the conflict-free schedule should be developed by exploring as many dispatching alternatives for every train as possible while upholding the transition of the network to stable operations, delivering explicit measures for every train that can be implemented in an actual situation. In this way, the deployment of line-specific DRP operating concepts carried out by this system would allow addressing challenges faced by current implementing practices - namely, a manual and subjective deployment of the DRP operating concepts.

The dynamic DRP deployment system required in subsection 3.2.2 was initially introduced in subsection 3.5.3. In addition to the adjustment of the schedule, the system was designed to address a second disruption-management problem, namely, the adjustment of circulation plans. By tackling both problems, the system should deliver a conflict-free schedule with the required precision (train number and minute-specific conflict-free schedule). Furthermore, the system was structured in such a way that it divided the disruption-management into two operational levels: line-specific and vehicle-specific. As discussed in subsection 3.5.2, the exploration of handling alternatives across both operational levels was conducted by means of a heuristic CDCR approach (i.e. heuristic identification and resolution of conflicts). The system was designed to identify and resolve conflicts at the line-specific operational level and refine, assess and select these solutions at the vehicle-specific operational level in order to establish the best handling alternatives for each of the trains. By dividing the disruption-management into two levels, the system is better able to explore as many dispatching measures as possible for the adjustment of the schedule and circulation plans, as required by subsection 3.4.2.

Overall, with the development of the dynamic DRP deployment system, the problem addressed in this *Section* of the work has been successfully resolved (see subsection 3.2.2).

At the line-specific operational level, the existence of the DRP operating concepts with their characteristic line-specific measures allows recognizing the challenges faced by every line for their transition to stable operations. In order to identify these challenges and explore the means to address them, a conflict identification approach that permits establishing potential conflict solution alternatives was designed in accordance with subsection 3.5.2. The approach was developed in section 8, where a framework for the identification and classification of line-specific conflicts was introduced. In this framework, the classification of conflicts was focused on the potential conflict solution alternatives under consideration of the time of day, the actual location of the trains, affected infrastructural elements (e.g. complete blockage) and in accordance with the line-specific DRP operating concept. Additionally, the establishment of potential line-specific solution alternatives was conducted employing a set of predefined elemental conflict solutions isolated by the classification, as foreseen by the general method (see subsection 3.5.2). For this purpose, 8 different line-specific elemental conflict solutions are derived from the 13 measures introduced in

subsection 3.6.2, which were subjected to the structured examination approach detailed in subsection 6.2. Based on the structured examination and a practical example, the 8 line-specific elemental conflict solutions were arranged in the hierarchical structure presented in subsection 6.4.

To ensure the exploration of as many handling alternatives to adjust the schedule and circulation plans for every train as detailed in the requirements (see subsection 3.4.2), an approach supporting the development of a series of Potential Vehicle-Specific Conflict Solutions in Time and Space (PVSCS) was proposed (see section 9). Every PVSCS developed for each train consisted of a combination of handling alternatives including: potential line-specific solution alternatives, one specific route across the infrastructure complemented with temporal information (e.g. arrival and departure times from nodes), and an adjusted circulation plan. Furthermore, to strive for the correct balance between exploring as many handling alternatives as possible and at the same time ensuring the effectiveness and efficiency of the system as detailed by the requirements (see subsection 3.4.2), the structured approach guiding the development of the PVSCS incorporated different approaches to curb the complexity during development. On the one hand, the development of the every PVSCS was conducted assuming an empty network under the consideration that they are later made conflict-free (i.e. fixed) at the vehicle-specific level, and supported by a right-shift rescheduling approach adjusted to be implemented within the context of planned disruption-management approaches. Additionally, two verification levels were introduced that ensured that only technically and operationally feasible PVSCS are developed (see subsections 9.6 and 9.7). Overall, the approach supporting the development of a series of technically and operationally feasible PVSCS for every train allowed the system to develop a wide range of dispatching alternatives with a particular focus on the transition to stable operations.

Moreover, since a series of individual PVSCS covering different handling alternatives for every train are developed, their assembly into PVSCS combinations (containing one PVSCS for every train in the network) was to be managed by a combinatorial heuristic as foreseen in subsection 3.5.2. This was done by dividing the combinatorial problem into sub-problems according to the system requirements (e.g. ensuring a transition to stable operations) and by exploring existing methods (see sections 10.2 and 10.3). As a result, a Genetic algorithm was utilized to manage the assembly of PVSCS combinations and combined with a Tabu Search algorithm specially designed to handle the entrance sequence of queuing trains to the LtFTS (Last Technically Feasible Turning Station). The handling of queuing trains in front of the station was deemed to be of prime importance for ensuring the network's transition to stability, as detailed by the system requirements (see subsection 3.4.2).

At the vehicle-specific operational level and according to subsection 3.5.2, the necessary processes to ensure that PVSCS combinations become conflict-free needed to be derived and established (i.e. fixed). This is the case since PVSCS combinations assembled in section 10 are constituted by the individual PVSCS for every train, which at the same time were developed considering an empty network. For this purpose, existing heuristic CDCR approaches were adjusted and modified in section 11 according to the system requirements (see subsection 3.4.2). The existing approaches were adjusted and modified in such a way that they were able to support the identification and development of a set of conflict resolution alternatives across the four types of vehicle-specific conflicts handled by the system. These include occupancy, infrastructure availability, circulation and service conflicts (see subsections 11.2 and 3.4.2). Service conflicts were introduced into this work due to the usual lack of scheduled connections between trains within the commuter railway system (see subsection 3.4.2) and in order to fulfill the objective of upholding service quality from

the passengers' perspective. Moreover, to further abide with the requirements, the interaction with other types of railway traffic within the vehicle-specific CDCR process (e.g. freight trains, regional trains) was also considered under the provision that information is made available to the system (see subsection 11.2 and 11.4.3).

To further uphold the quality of the CDCR process and enhance the handling of vehicle-specific conflicts in areas that are significant to the transition to stable operations (i.e. critical areas), the processes supporting the development of conflict resolution alternatives have been designed to conduct a particularly detailed exploration of alternatives within the critical area of the network. This was achieved by allowing the utilization of an increased number of elemental conflict solutions and a wider exploration of infrastructural elements to resolve the identified conflicts.

Furthermore, as described in the general method (see subsection 3.5.2) and analogous to the line-specific operational level, the process supporting the development of conflict resolution alternatives at the vehicle-specific level was designed to incorporate predefined elemental conflict solutions. For this purpose, 6 vehicle-specific elemental conflict solutions have been derived from the 13 measures introduced in subsection 3.6.2, which were subjected to the structured examination approach detailed in subsection 6.2. From the structured examination, the 6 elemental conflict solutions utilized at the vehicle-specific operational level have been further bundled according to the conflict type in subsection 6.5.

Following the implementation of the CDCR approaches at the vehicle-specific level, an assessment of the conflict resolution alternatives needed to be designed in accordance with the general method (see subsection 3.5.2). The assessment was derived in section 12 to support the selection of conflict resolution within a set of alternatives developed as a part of the vehicle-specific CDCR process (regardless of the conflict type). The assessment was designed to evaluate four determining variables that account for the influence of the elemental conflict solutions used to develop the resolution alternatives (see subsection 12.2). The evaluation framework for each of the determining values detailed in subsection 12.3 was derived from existing approaches, considering the practical handling of disruptions, and ensuring that all are assessed from a temporal point of view so as to evaluate the determining variables such that they are comparable with each other as foreseen by the general method (see subsection 3.5.2).

Moreover, in line with the general method discussed in subsection 3.5.2, the assessment framework needed to be complemented by a process that assesses the fitness of the resulting conflict-free PVSCS combinations. This assessment was structured in subsection 12.2 such that it applies the evaluated temporal effects of the conflict resolution alternatives already chosen at every step of the CDCR process to fix (i.e. make conflict-free) the PVSCS combination. This was then further complemented with an evaluation of two additional determining variables detailed in subsection 12.3. Here too, the evaluation was structured so as to support a uniform temporal assessment, making the evaluated determining values comparable with each other. The ascertained fitness of the PVSCS combinations is communicated to the metaheuristic algorithms (section 10), which utilizes the information for the exploration of the search space (i.e. assembly of new PVSCS combinations).

Lastly, to further uphold the quality of the conflict-free PVSCS combinations obtained by the system, which by this point already constitute conflict-free schedules, the system's general method recognized the need to support a final adjustment process (see subsection 3.5.2). The adjustment process of the conflict-free schedules detailed in section 13 was based on the basic principles

introduced within an existing approach and was designed to identify and remove unnecessary measures introduced during the CDCR process. The adjustment of the conflict-free schedules is the last step in the system and permits to ensure that the quality of the conflict-free schedule proposed by the system is compatible with those established in the requirements (see subsection 3.5.4).

Throughout the development of each of the modules of the dynamic DRP deployment system, the necessary adjustments on processes across the different modules that permitted to make the overall system more compatible with the available computational effort were identified, as detailed in the system's requirements. Finally, in section 14, the implementation of the system's modules on an actual disrupted situation has been summarized and laid out. Throughout this example, the feasibility of dividing the disruption-management problem into two operational levels was demonstrated.

All in all, this work has established the foundation for the development of a dynamic DRP deployment system. The system facilitates the allocation of dispatching measures to the different trains circulating in the disrupted network while taking into consideration the ability of the disrupted network to transition to stable operations. In so doing, dispatchers are not only better equipped to make decisions based on a solution conducive to solving line-specific conflicts with vehicle-specific detail but also they are better able to deal with the train queue formed around the disrupted section at the beginning of the disruption.

15.2. Conclusions

The basis for the dynamic deployment of existing DRP operating concepts on the actual operating situation has been derived and assembled in the system detailed in the second *Section* of this work and briefly summarized in the previous subsection. The system enables the implementation of line-specific measures contained in a DRP operating concept at a vehicle-specific level and ultimately generates a train number and minute-specific conflict-free schedule. The conflict-free schedule is a result of adjustments made to the existing schedule and circulation plans in accordance with the actual operating situation of the disrupted network. In the process, the components of the system result in the network's transition to stable operations, thereby achieving the specific objective of the second *Section*.

It is also evident that the system fulfills its specific objective when comparing its aptitudes vis-à-vis the four recommendations for improving the transition to stable operations introduced by Oetting and Chu (2013). Moreover, it overcomes most of the shortcomings of implementing existing DRPs discussed by Ghaemi et al. (2016) (see subsection 2.3.3).

Regarding the four recommendations introduced in Oetting and Chu (2013) detailed in subsection 2.3.3, three of them are relevant at the operational level, namely, choice of turning stations, limiting delay propagation in turning stations and improving the operating procedures during the transition phase. The fourth recommendation focuses on the communication process during the disruption; thus, it does not have any direct relevance for the objectives of the system. Of the three recommendations applicable to the system's specific objective, all three are accomplished as detailed below:

1. Choice of turning stations: In the system, the development of the PVSCS for every train ensures that various turning stations and transition train services appointed to the train at the turning stations are considered in order to explore different handling alternatives.

-
2. Limiting delay propagation in turning stations: In the system, every PVSCS has been preemptively validated to ensure that the delay is able to be reduced (see subsection 9.7). In this way, the delay propagation has been partially addressed at the line-specific operational level. Furthermore, every conflict resolution alternative developed by the CDCR process at the vehicle-specific level is foreseen to have evaluated its influence on the affected trains' transition to the train services detailed in the adjusted circulation plans (see subsection 12.3.2). The evaluation accounts for a potential delay propagation that may be induced by the CDCR process.
 3. Improving the operating procedures during the transition phase: The development of the system in itself addresses this recommendation as the authors clearly identify that the manual deployment of DRPs jeopardies the ability of the system to reach stable operations efficiently. Additionally, a Tabu Search algorithm has been specially designed to handle queuing trains in front of the last technically feasible turning stations by exchanging their entrance sequences and thus exploring different solution alternatives for every assembled PVSCS combination. This feature is especially time-saving, as early turns and the altering of the handling sequence of trains throughout the critical area strongly contributes to reducing the transition time and reaching a stable operation soon after the occurrence of a disruption.

The shortcomings identified by Ghaemi et al. (2016) have also been partially addressed. First, the authors claim that DRPs need to be updated in accordance with any changes in the schedule or the infrastructure. While this remark falls outside the scope of the objective being address by the second *Section* (see table 3.1 - “deployment of the DRPs on the actual availability of infrastructure”), the dynamic DRP deployment system and the processes introduced throughout the modules described in this work have established a foundation for the introduction of a system that is not only able to adjust the schedule and circulation plans but also the DRP operating concepts before their deployment. Finally, just as in Oetting and Chu (2013), Ghaemi et al. (2016) also highlight the lack of a framework that allows DRPs to deal with the transition phase. As argued above, the processes within the system's modules have been explicitly derived to address this shortcoming.

Throughout the development of the method, the relevance of two matters in schedule adjustment becomes apparent. Initially, at the beginning of the disruption, the operating situation of a line (i.e. the actual position of vehicles and the service interval respective to the time of day) as outlined by the DRP operating program, directly determines how trains are subsequently handled by the system. Furthermore, the infrastructure layout around the last technically feasible turning station requires special attention to ensure more time-saving solutions and is a vital influencing factor when determining the overall complexity of the problem as well as the computation time of the system.

Furthermore, the dynamic DRP deployment system has been designed in such a way that it can be applied to disruptions affecting any commuter railway network regardless of their operating context. Although the general validity of the approach has been upheld in every module, the system implementation is restricted to a planned disruption-management approach. Therefore, the implementation of the system takes for granted the availability of a set of DRP operating concepts for the railway network and staff, preemptively prepared to handle the implementation of any of the DRPs available in the set.

Every single one of the modules that constitute the dynamic DRP deployment system has been theoretically detailed in this work. While the basic procedures have been described for each of the system's modules, an implementation within practical instances to test and evaluate the effectiveness and efficiency of the proposed heuristics is still necessary. Particular attention must be paid to the components of the heuristics detailed in sections 10.4, 10.5 and 10.6 vis-à-vis the computation time required by the system to generate a conflict-free schedule as well as the fitness of the resulting conflict-free schedules. Implementation within practical instances is also still necessary in order to establish the values of the introduced parameters, for example, the calibrating time utilized to derive an effective weighting function for the conflict severity (see subsections 12.3.2).

In addition to the heuristics introduced in the different modules, it is also possible to derive alternative processes by applying the different methods detailed in subsection 3.5.1. For example, exact methods can be applied for the resolution of the vehicle-specific conflicts and formulated as a job-shop problem. These methods should be introduced in the system such that they are compatible with the processes supported between modules, for example, abiding by the constraints dictated by the Tabu Search algorithm for the resolution of conflicts near the last technically feasible turning station. Nonetheless, the comparison regarding the implementation of different approaches must also be conducted within practical instances and supported by expert judgement.

Finally, it should be noted that while this model provides a robust general framework, there is room for improvement throughout the presented modules. The ability of the vehicle-specific CDCR approach to support dynamic-speed models is the most pressing. Incorporating this alternative as part of the elemental conflict solutions to solve occupancy, infrastructure availability and circulation conflicts would allow for the development of a conflict-free schedule much more suitable for capacity consumption. This is particularly the case for conflicts within the critical area of the network. Nonetheless, the utilization of the measure must also be considered vis-à-vis the additional computational effort needed when extending the number of conflict resolution alternatives that can be generated plus the subsequent identification and removal of potentially unnecessary measures within the resulting conflict-free schedules.

Furthermore, additional modules could also be incorporated into the system. For example, a module that predicts or estimates the length of the disruption can be incorporated to mediate the adjustment of both the schedule and circulation plans. Another alternative would be an additional module that supports an automatic selection of the DRP operating concept from the set of DRPs available for the network that better fits with the actual operating situation. Both of these modules would allow the system to further automate the dynamic deployment of the DRP in the actual operating situation. Ultimately, perhaps the most important addition would be a module or parallel system that permits adjusting existing DRPs to the actual availability of infrastructure (see table 3.1). In such a context, the dynamic DRP deployment system proposed in this work could be used to project the proposed adjustments in the investigated DRP on the actual operating situation until an adequate alternative is established. In such a context, the computational time of the dynamic DRP deployment system would play a much more preeminent role, as multiple DRP operating concepts would potentially need to be tested.

16. General Outlook

This work highlights the relevance of preparedness and prevention (P&P) strategies in a critical infrastructure resilience framework, concentrating on disruption programs (DRPs) for German commuter railway networks. Both *Sections* of this work improve upon existing P&P strategies for commuter railway networks (see table 3.1). Firstly, the model developed within this work permits decision-makers to consider the capacity limitations of the means of public transport during the assessment of the passenger rerouting strategies of DRP transport concepts. Secondly, it establishes a system for the dynamic deployment of the existing DRP operating concepts on the actual operating situation of a disrupted commuter railway network.

By means of the general residual capacity estimation model introduced in *Section 1*, the development of DRPs is enhanced, as the commuter railway network's P&P strategies to deal with disruptions. By integrating this model within exiting DRP development models, such as those discussed in subsection 2.3.3, a much more robust framework for the development of DRP transport concepts is established. The enhancement of the developmental framework of DRP inherently results in much more robust DRP operating and transport concepts, which are later implemented to cope with disrupted situations.

DRP operating concepts are, for the most part, being deployed manually by strained dispatchers. Thus, the dynamic DRP deployment system overcomes the subjectivity previously inherent within current deployment practices. Since the system has been designed not only to support the deployment of the DRP but also the transition of the system to stable operations, the benefits of a planned disruption-management approach (i.e. P&P based) are secured and enhanced. It is, however, still necessary to provide a framework that supports the adjustment of DRP operating concepts to the actual infrastructure availability or changes in the schedule.

Ultimately, when considering the role, benefits and drawbacks that characterize the use of DRPs as disruption-management tools within commuter railway operations, it can be concluded that such strategies are central elements for upholding “acceptable level of functioning” during disrupted operations. In principle, they enable the system to avoid the complete breakdown of its operations and bounce back from a degraded state, protecting its most basic operational capabilities and enabling both decision-makers as well as users to better cope with adverse circumstances. Thus, through the improvements to DRPs proposed throughout both sections of this work, dispatchers would be able to rapidly regain control of the railway system during a disruption by ensuring that the necessary adjustments are being introduced.

Conclusively, P&P measures developed for implementation in critical infrastructures, regardless of being conceived over fixed scenarios, help pave the way for infrastructural systems to adapt and transform during disrupted operations, supporting a return to stable operations.

Bibliography

- Acuña-Agost, Rodrigo (2009) *Mathematical modeling and methods for rescheduling trains under disrupted operations*. Doctoral Dissertation. Université d'Avignon et des Pays de Vaucluse, Avignon.
- Affenzeller, Michael and Mayrhofer, Rene (2002). Generic heuristics for combinatorial optimization problems. In: *9th International Conference on Operational Research*, vol. 2002, 83-92.
- Alfieri, Arianna; Groot, Rutger; Kroon, Leo G. and Schrijver, Alexander (2006). Efficient Circulation of Railway Rolling Stock. *Transportation Science*, 40(3), S. 378–391. doi:10.1287/trsc.1060.0155.
- Alonso, William (1964). *Location and Land Use. Toward a General Theory of Land Rent*. Harvard University Press, Cambridge. isbn:9780674729568.
- Bach, Claudia; Bouchon, Sara; Fekete, Alexander; Birkmann, Jörn and Serre, Damien (2013). Adding value to critical infrastructure research and disaster risk management: the resilience concept. *Resilient Cities*, 6(1), 1-12.
- Bär, Matthias (1996). Konflikte im Eisenbahnbetrieb - Versuch einer Systematisierung. In: *Schriftenreihe des Instituts für Verkehrssystemtheorie und Bahnverkehr*. Technische Universität Dresden, 2, 138-149.
- Ben-Khedher, Nejjib; Kintanar, Josephine; Queille, Cecile and Stripling, William (1998). Schedule Optimization at SNCF: From Conception to Day of Departure. *INTERFACES*, 28(1), 6–23.
- Bertaud, Alain, and Malpezzi, Stephen (2003). The spatial distribution of population in 48 world cities: Implications for economies in transition. *Center for urban land economics research, University of Wisconsin*, 32(1), 54-55.
- Bertaud, Alain (2003). The spatial organization of cities: Deliberate outcome or unforeseen consequence?. In: *World Development Report 2003: Dynamic Development in a Sustainable World*, World Bank, Washington, DC.
- Bhandari, Dinabandhu; Murthy, C. A. and K. Pal, Sankar (2012). Variance as a stopping criterion for genetic algorithms with elitist model. *Fundamenta Informaticae*, 120(2), 145-164.
- Blickle, Tobias, and Thiele, Lothar (1995). A Mathematical Analysis of Tournament Selection." In: *ICGA*, 95, 9-15.
- Boltze, Manfred and Dinter, Michael (1996). Wirkungspotentiale von Informationssystemen im Verkehr. *Straßenverkehrstechnik*, 40(7), 314–319.
- Boltze, Manfred; Jentsch, H. et al. (2007). Erschließung von Entscheidungs- und Optimierungsmethoden für die Anwendung im Verkehr. In: *OptiV*. www.optiv.de. Köln: Forschungsgesellschaft für Straßen- und Verkehrswesen.
- Borndörfer, Ralf; Neumann, Marika and Pfetsch, Marc E. (2009). The line connectivity problem. In: *Operations Research Proceedings 2008*. Springer, Berlin, Heidelberg, 557-562.
- Bouman, Paul; Schmidt, Marie; Kroon, Leo and Schöbel, Anita (2013). Passenger route choice in case of disruptions. In: *16th International IEEE Conference on Intelligent Transportation Systems (ITSC)*, 2013. 6-9 Oct. 2013, Kurhaus, The Hague, The Netherlands.

-
- Brauner, Anna-Katharina (2019). Automated Evaluation of pre-planned Operating Concepts for Disruptions in Commuter Railway Transport. *Transportation Research Procedia*, 37, 19-26.
- Brauner, Anna-Katharina and Oetting, Andreas (2019). Pre-planned Disruption Management in Commuter Railway Transportation: Algorithms for (partial) Automation of passenger-oriented Design and Evaluation. In: *RailNorrköping 2019. 8th International Conference on Railway Operations Modelling and Analysis (ICROMA)*, Norrköping, Sweden, June 17th – 20th, 2019.
- Brinckerhoff, Parsons (2013). *Transit Capacity and Quality of Service Manual*. Third Edition. Washington, D.C.: Transportation Research Board.
- Budai, Gabriella; Maróti, Gábor; Dekker, Rommert; Huisman, Dennis and Kroon, Leo (2010). Rescheduling in passenger railways: the rolling stock rebalancing problem. *Journal of Scheduling*, 13(3), 281-297. doi:10.1007/s10951-009-0133-9.
- Büker, Thorsten and Bernhard, Seybold (2012). Stochastic modelling of delay propagation in large networks. *Journal of Rail Transport Planning & Management*, 2(1–2), 34-50.
- Brucker, Peter (2007). *Scheduling Algorithms*. Dordrecht: Springer. Online verfügbar unter <http://gbv.eblib.com/patron/FullRecord.aspx?p=337422>.
- Brünger, Olaf (1995). *Konzeption einer Rechnerunterstützung für die Feinkonstruktion von Eisenbahnfahrplänen*. Doctoral Dissertation. Rheinisch-Westfälischen Technischen Hochschule Aachen, Aachen.
- Cadarso, Luis; Marín, Ángel and Maróti, Gábor (2013). Recovery of disruptions in rapid transit networks. *Transportation Research Part E: Logistics and Transportation Review*, 53, 15-33.
- Cadarso, Luis and Marín, Ángel (2013). Robust passenger oriented timetable and fleet assignment integration in airline planning. *Journal of Air Transport Management*, 26, 44-49. doi:10.1016/j.jairtraman.2012.10.004.
- Caimi, Gabrio; Fuchsberger, Martin; Laumanns, Marco and Lüthi, Marco (2012). A model predictive control approach for discrete-time rescheduling in complex central railway station areas. *Computers & Operations Research*, 39(11), 2578–2593. doi: 10.1016/j.cor.2012.01.003.
- Cao, Nan (2017). *Approach to determine and evaluate the homogeneity of operating programs in railway operation based on infrastructure occupancy*. Doctoral Dissertation. Universität Stuttgart, Stuttgart.
- Carey, Malachy, and Kwieciński, Andrzej (1994). Stochastic approximation to the effects of headways on knock-on delays of trains. *Transportation Research Part B: Methodological*, 28(4), 251-267.
- Cats, Oded and Jenelius, Erik (2015). Planning for the unexpected: The value of reserve capacity for public transport network robustness. *Transportation Research Part A: Policy and Practice*, 81, 47-61. doi:10.1016/j.tra.2015.02.013.
- Cats, Oded; West, Jens and Eliasson, Jonas (2015). Appraisal of increased public transport capacity: the case of a new metro line to Nacka, Sweden. In: *Working papers in Transport Economics 2015(2)*, CTS - Centre for Transport Studies Stockholm (KTH and VTI).
- Chiang, Te-Wie and Hau, Hai-Yen (1995). Railway Scheduling System Using Repair-based Approach. In: *7th International Conference on Tools with Artificial Intelligence*, 71–78.
- Chiang, Te-Wei; Hau, Hai-Yen; Chiang, Hwan-Ming; Ko, Su-Yun and Hsieh, Chao-Ho (1998). Knowledge-based system for railway scheduling. *Data & Knowledge Engineering*, 27, 289–312.

-
- Chelleri, Lorenzo; Waters, James J.; Olazabal, Marta and Minucci, Guido (2015). Resilience trade-offs: addressing multiple scales and temporal aspects of urban resilience. *Environment and Urbanization*, 27(1), 181-198. doi:10.1177/0956247814550780
- Chen, Anthony; Kasikitwiwat, Panatda and Yang, Chao (2013). Alternate capacity reliability measures for transportation networks. *Journal of Advanced Transportation* 47(1), 79-104.
- Christoforou, Zoi; Corbille, Etienne; Farhi, Nadir, and Leurent, Fabien (2016). Managing Planned Disruptions of Mass Transit Systems. *Transportation Research Record*, 2541(1), 46-55.
- Chu, Friederike and Fornauf, Leif (2011). Vom Katastrophen- und vom dynamischen Straßenverkehrsmanagement lernen – Störfallprogramme bei Betriebsstörungen im Schienenverkehr. In: *HEUREKA '11 – Optimierung in Verkehr und Transport Forschungsgesellschaft für Straßen- und Verkehrswesen, 2011*.
- Chu, Friederike; Fornauf, Leif; Böhme, Aline and Wolters, Achim (2012). Methode zur Erarbeitung von Störfallprogrammen. *Deine Bahn*, 7, 45–48.
- Chu, Friederike and Oetting, Andreas (2013). Modeling capacity consumption considering disruption program characteristics and the transition phase to steady operations during disruptions. *Journal of Rail Transport Planning & Management*, 3(3), 54-67.
- Chu, Friederike (2014). *Beurteilung von Störfallprogrammen anhand ihres Einschwingverhaltens am Beispiel des Schienenpersonennahverkehrs*. Doctoral Dissertation. Technische Universität Darmstadt, Darmstadt.
- Collier, Stephen J. and Lakoff, Andrew (2008). Distributed preparedness: the spatial logic of domestic security in the United States. *Environment and Planning D: Society and Space*, 26(1), 7-28. doi:10.1068/d446t
- Corman, Francesco (2010). *Real-time Railway Traffic Management: Dispatching in complex, large and busy railway networks*. Doctoral Dissertation. Technische Universität Delft, Delft.
- Corman, Francesco; D'Ariano, Andrea; Pacciarelli, Dario and Pranzo, Marco (2010). Centralized versus distributed systems to reschedule trains in two dispatching areas. *Public Transport* 2(3), 219-247.
- Corman, Francesco; D'Ariano, Andrea; Hansen, Ingo A.; Pacciarelli, Dario and Pranzo, Marco (2011). Dispatching trains during seriously disrupted traffic situations. In: *2011 International Conference on Networking, Sensing and Control*, 323-328. *IEEE*.
- Corman, Francesco; D'Ariano, Andrea; Pacciarelli, Dario and Pranzo, Marco (2012). Bi-objective conflict detection and resolution in railway traffic management. *Transportation Research Part C: Emerging Technologies*, 20(1), 79–94. doi:10.1016/j.trc.2010.09.009.
- Corman, Francesco and Quaglietta, Egidio (2015). Closing the loop in real-time railway control: Framework design and impacts on operations. *Transportation Research Part C: Emerging Technologies*, 54, 15-39. doi: 10.1016/j.trc.2015.01.014.
- Crespo, Arturo; Dombois, Marcus and Henning, Jan (2018). Preparedness & Prevention. In: *Jens Ivo Engels (eds.): Key Concepts for Critical Infrastructure Research. 1st edition 2018. Wiesbaden: Springer Fachmedien Wiesbaden GmbH; Springer, 39-44*.
- Crespo, Arturo and Oetting, Andreas (2018). Public transport capacity limitations. Means for a prompt Occupancy Rate (O.R.) evaluation. *Internationales Verkehrswesen, DVV Media Group*, 70(3), 84-87.

-
- Currie, Graham and Muir, Carlyn (2017). Understanding Passenger Perceptions and Behaviors During Unplanned Rail Disruptions. *Transportation Research Procedia*, 25, 4392-4402. doi:10.1016/j.trpro.2017.05.322.
- D'Ariano, Andrea (2008). *Improving Real-Time Train Dispatching: Models, Algorithms and Applications*. Doctoral Dissertation. Technische Universiteit Delft, Delft.
- DB Netz RIL-402 (2008). *Richtlinie 402 – Trassenmanagement*. DB Netz AG.
- DB Netz RIL-405 (2009). *Richtlinie 405 – Fahrwegkapazität*. DB Netz AG.
- DB Netz RIL-408 (2012). *Richtlinie 408 – Züge fahren und Rangieren*. DB Netz AG.
- DB Netz RIL-420 (2017). *Richtlinie 420 – Betriebszentralen*. DB Netz AG.
- DB Netz (2017). *Interne Präsentation zur Entwicklung eines Konfliktassistenzsystems*. DB Netz AG - I.NPB 5. Unpublished presentation.
- DB Netz RIL-438 (2018). *Richtlinie 438 – Fahrdienstvorschrift; FV-NE*. DB Netz AG.
- DB Netz (2019) *Technische Netzzugangsbedingungen (TNB) - Technischer Netzzugang*. DB Netz AG.
- DB Regio RIL-615 (2014). *Richtlinie 615 – Transportleitung Personenverkehr*. DB Regio AG.
- DB Regio AG (2016). *Streckenfahrplan: S-Bahn Rhein-Main*. Marketing/Fahrplanmedien, Mannheimer Straße 81, 60327 Frankfurt am Main. DB Regio AG.
- DB Regio AG (2017). *ZWL mit Sperrung der Tunnel-Stammstrecke der S-Bahn Frankfurt (Main)*. DB Regio AG. Unpublished figure.
- Deutsche Bahn AG (n.d.a). *S-Bahn Rhein-Main: Rückgrat des öffentlichen Schienennahverkehrs im Rhein-Main-Gebiet / 540.000 Fahrgäste am Tag*. Retrieved from: https://www.deutschebahn.com/pr-frankfurt-de/aktuell/Themendienst_S-Bahn_Rhein-Main-3674698, Last accessed on: 09.10.2019.
- De-Los-Santos, Alicia; Laporte, Gilbert; Mesa, Juan A. and Perea, Federico (2012). Evaluating passenger robustness in a rail transit network. *Transportation Research Part C: Emerging Technologies*, 20(1), 34-46.
- Deutsche Bahn AG (n.d.b). *Personenverkehr, Unternehmensbereich; eCommerce, Marketing: Zahlen, Daten und Fakten*. Retrieved from: https://www.s-bahn-muenchen.de/s_muenchen/view/wir/daten_fakten.shtml, Last accessed on: 07.10.2019.
- Dorbritz, Robert and Anderhub, Gabriel (2007). How many passengers can public transport systems handle and how much do they handle- A new approach to capacity. In: *7th Swiss Transport Research Conference, Monte Verità, Ascona, Switzerland, September 12th-14th, 2007*.
- Dorbritz, Robert and Weidmann, Ulrich (2012). Auswirkungen schwerer Störungen auf Bahnnetze. *ZEVrail*, 136(6-7), 212–225.
- Dollevoet, Twan; Huisman, Dennis; Schmidt, Marie and Schöbel, Anita (2012). Delay management with rerouting of passengers. *Transportation Science*, 46(1), 74-89.
- Dollevoet, Twan; Huisman, Dennis; Kroon, Leo G.; Veelenturf, Lucas P. and Wagenaar, Joris C. (2017). Application of an iterative framework for real-time railway rescheduling. *Computers & Operations Research*, 78, 203-217.

-
- Eaton, Jayne; Yang, Shengxiang and Mavrovouniotis, Michalis (2016). Ant colony optimization with immigrants schemes for the dynamic railway junction rescheduling problem with multiple delays. *Soft Computing*, 20(8), 2951-2966. doi:10.1007/s00500-015-1924-x
- Fan, Bo; Roberts, Clive and Weston, Paul (2012). A comparison of algorithms for minimising delay costs in disturbed railway traffic scenarios. *Journal of Rail Transport Planning & Management*, 2, 23-33. doi:10.1016/j.jrtpm.2012.09.002
- Fay, Alexander (1999). *Wissensbasierte Entscheidungsunterstützung für die Disposition im Schienenverkehr: Eine Anwendung von Fuzzy-Petrinetzen*. Düsseldorf: VDI Verlag.
- Fekete, Sandor P.; Kroeller, Alexander; Lorek, Martin and Pfetsch, Marc (2011). Disruption Management with Rescheduling of Trips and Vehicle Circulations. Available in: *arXiv preprint arXiv:1101.2123*.
- Festa, Paola (2014). A brief introduction to exact, approximation, and heuristic algorithms for solving hard combinatorial optimization problems. In: *ICTON 2014. 16th International Conference on Transparent Optical Networks : Graz, 6th-10th July, 2014*.
- Fioole, Pieter-Jan; Kroon, Leo; Maróti, Gábor and Schrijver, Alexander (2006). A rolling stock circulation model for combining and splitting of passenger trains. *European Journal of Operational Research*, 174(2), 1281-1297.
- Fischer, Klaus and Hertel, Günter (1990). *Bedienungsprozesse im Transportwesen. Grundlagen und Anwendungen der Bedienungstheorie*. Berlin: Transpress-Verl.-Ges.
- Folke, Carl; Carpenter, Stephen; Walker, Brian; Scheffer, Marten; Chapin, Terry and Rockström, Johan (2010). Resilience thinking: integrating resilience, adaptability and transformability. *Ecology and Society* 15(4), 20. [online] URL: <http://www.ecologyandsociety.org/vol15/iss4/art20/>
- Ghaemi, Nadjla; Cats, Oded and Goverde, Rob M. (2016). Railway disruption timetable: Short-turnings in case of complete blockage. *2016 IEEE International Conference on Intelligent Rail Transportation (ICIRT), Birmingham, 2016*, 210-218. doi:10.1109/ICIRT.2016.7588734
- Ghaemi, Nadjla; Cats, Oded and Goverde, Rob M.P. (2017). A microscopic model for optimal train short-turnings during complete blockages. *Transportation Research Part B: Methodological*, 105, 423-437. doi:10.1016/j.trb.2017.10.002.
- Ghaemi, Nadjla; Cats, Oded and Goverde, Rob M.P. (2018a). Macroscopic multiple-station short-turning model in case of complete railway blockages. *Transportation Research Part C: Emerging Technologies*, 89, 113-132. doi:10.1016/j.trc.2018.02.006.
- Ghaemi, Nadjla; Zilko, Aurelius A.; Yan, Fei; Cats, Oded; Kurowicka, Dorota and Goverde, Rob M.P. (2018b). Impact of railway disruption predictions and rescheduling on passenger delays. *Journal of Rail Transport Planning & Management*, 8(2), 103-122. doi:10.1016/j.jrtpm.2018.02.002.
- Ghoreishi, Seyyedeh Newsha; Clausen, Anders and Nørregaard Jørgensen, Bo (2017). Termination Criteria in Evolutionary Algorithms: A Survey. In: *IJCCI*, 373-384.
- Gille, Andreas; Klemenz, Marc and Siefer, Thomas (2008). Applying multiscaling analysis to detect capacity resources in railway networks. *WIT Transactions on The Built Environment*, 103, 595-603.

- Ginkel, Andreas and Schöbel, Anita (2007). To Wait or Not to Wait? The Bicriteria Delay Management Problem in *Public Transportation*. *Transportation Science* 41(4), 527-538. doi:10.1287/trsc.1070.0212.
- Glover, Fred (1989). Tabu Search—Part I. In: *ORSA Journal on Computing*, 1(3), 190–206. doi:10.1287/ijoc.1.3.190.
- Glover, Fred; Taillard, Eric and Werra, Dominique (1993). A user's guide to Tabu Search. *Annals of Operations Research*, 41(1), 1–28.
- Glover, Fred (1995). *Tabu Search fundamentals and uses*. Boulder: Graduate School of Business, University of Colorado.
- Godschalk, David R. (2003) Urban Hazard Mitigation: Creating Resilient Cities. *Natural Hazards Review*, 4(3), 136-143. doi:10.1061/(ASCE)1527-6988(2003)4:3(136)
- Haahr, Jørgen T.; Wagenaar, Joris C.; Veelenturf, Lucas P. and Kroon, Leo (2016). A comparison of two exact methods for passenger railway rolling stock (re)scheduling. *Transportation Research Part E: Logistics and Transportation Review*, 91, 15-32. doi:10.1016/j.tre.2016.03.019.
- Haimes, Yacov Y.; Crowther, Kenneth and Horowitz, Barry M. (2008). Homeland security preparedness: Balancing protection with resilience in emergent systems. *Systems Engineering*, 11(4), 287-308. doi:10.1002/sys.20101
- Hamburger Verkehrsverbund GmbH (HVV) (2016a). *U/S/A/R-Plan*. Retrieved from: <https://www.hvv.de/de/plaene>
- Hamburger Verkehrsverbund GmbH (HVV) (2016b). *Fahrgastzahlen (Nachfrageniveau Frühling 2016)* [Data file: Anzahl der ein- und aussteigenden Passagiere pro Linie]. Unpublished raw data.
- Hamburger Verkehrsverbund GmbH (HVV) (2016c). *Verkehrsnetzplan*. Retrieved from: <https://geofox.hvv.de/jsf/mapsOSM.seam>
- Hansen, Ingo A. (2009). Railway network timetabling and dynamic traffic management. In: *2nd International Conference on Recent Advances in Railway Engineering, ICRARE-2009, Tehran, I.R. Iran, Sept. 27-28, 2009*.
- Hansen, Ingo A. and Pachl, Jörn (eds.) (2014). *Railway timetabling & operations. Analysis, modelling, optimization, simulation, performance evaluation*. Hamburg: Eurailpress.
- Happel, O. (1959). Sperrzeiten als Grundlage der Fahrplankonstruktion. *Eisenbahntechnische Rundschau*, 8(2), 79-80.
- Hémond, Yannick and Robert, Benoît (2012). Preparedness: the state of the art and future prospects. *Disaster Prevention and Management* 21(4), 404-417. doi:10.1108/09653561211256125.
- Hillier, Frederick S. and Lieberman, Gerald J. (2015). *Introduction to operations research*. 10. New York, NY: McGraw-Hill Education.
- Holland, J. H. (1975). *Adaptation in Natural and Artificial Systems*. University of Michigan Press.
- Huber, Hans-Peter and Wilfinger, Georg (2006). Integration-enhancements for microscopic and macroscopic railway infrastructure planning models. In: *Proceedings of 7th World Congress on Railway Research*.

-
- Huisman, Dennis; Kroon, Leo G.; Lentink, Ramon M.; Vromans, Michiel J. C. M. (2005). Operations Research in passenger railway transportation. *Statistica Neerlandica* 59(4), 467-497. doi: 10.1111/j.1467-9574.2005.00303.x.
- Jacobs, J. (2004). Reducing delays by means of computer-aided 'on-the-spot' rescheduling. In: *WIT Transactions on The Built Environment*, 74.
- Jespersen-Groth, Julie; Potthoff, Daniel; Clausen, Jens; Huisman, Dennis; Kroon, Leo; Maróti, Gábor; Nielsen and Morten Nyhave (2009). Disruption Management in Passenger Railway Transportation. In: *Rolf H. Möhring, Christos D. Zaroliagis und Ravindra K. Ahuja (eds.): Robust and online large-scale optimization. Models and techniques for transportation systems Bd. 5868. Berlin: Springer, 399-421.*
- Jin, Jian Gang; Tang, Loon Ching; Sun, Lijun and Lee, Der-Horng (2014). Enhancing metro network resilience via localized integration with bus services. *Transportation Research Part E: Logistics and Transportation Review*, 63, 17-30. doi:10.1016/j.tre.2014.01.002.
- Johansson, Jonas and Hassel, Henrik (2010). An approach for modelling interdependent infrastructures in the context of vulnerability analysis. *Reliability Engineering & System Safety*, 95(12), 1335-1344. doi:10.1016/j.res.2010.06.010.
- Kepaptsoglou, Konstantinos and Karlaftis, Matthew G. (2009). The bus bridging problem in metro operations: conceptual framework, models and algorithms. *Public Transport*, 1(4), 275-297. doi:10.1007/s12469-010-0017-6.
- King, David (2007). Organisations in Disaster. *Natural Hazards* 40(3), 657-665. doi:10.1007/s11069-006-9016-y.
- Kirkpatrick, Scott; Gelatt, Daniel and Vecchi, Mario P. (1983). Optimization by Simulated Annealing. *Science*, 220(4598), 671-680.
- Klinger, Thomas; Kenworthy, Jeffrey R.; Lanzendorf, Martin (2013). Dimensions of urban mobility cultures – a comparison of German cities. *Journal of Transport Geography*, 31, 18-29. doi:10.1016/j.jtrangeo.2013.05.002.
- Kremer, Helmut and Rink, Michael (2016). Normiertes Dispositionsmanagement S-Bahn Rhein-Main. Eds. *Transportleitung Regio Hessen*. Unpublished manuscript.
- Kroon, Leo G.; Romeijn, H. Edwin and Zwaneveld, Peter J. (1997). Routing trains through railway stations: complexity issues. *European Journal of Operational Research*, 98(3), 485-498.
- Kroon, Leo; Maróti, Gábor and Nielsen, Lars (2015). Rescheduling of Railway Rolling Stock with Dynamic Passenger Flows. *Transportation Science*, 49(2), 165-184. doi:10.1287/trsc.2013.0502.
- Kuckelberg, Alexander (2011). *Mikroskopische Disposition spurgebundener Verkehrsmittel unter Echtzeitbedingungen*. Doctoral Dissertation. Rheinisch-Westfälischen Technischen Hochschule Aachen, Aachen.
- Kurby, Stephan (2012). *Makroskopisches Echtzeitdispositionsmodell zur Lösung von Anschlusskonflikten im Eisenbahnbetrieb*. Doctoral Dissertation. Technische Universität Dresden, Dresden.
- Lefèvre, Benoit (2009). Urban Transport Energy Consumption: Determinants and Strategies for its Reduction. An analysis of the literature. *SAPI EN. S. Surveys and Perspectives Integrating Environment and Society* 2.3.

-
- Lemnian, Martin; Rückert, Ralf; Rechner, Steffen; Blendinger, Christoph and Müller-Hannemann, Matthias (2014). Timing of train disposition: Towards early passenger rerouting in case of delays. In: *14th Workshop on Algorithmic Approaches for Transportation Modelling, Optimization, and Systems. Schloss Dagstuhl-Leibniz-Zentrum für Informatik.*
- Leurent, Fabien (2011). Transport capacity constraints on the mass transit system: a systemic analysis. *European Transport Research Review*, 3(1), 11-21. doi:10.1007/s12544-011-0046-5.
- Liebchen C. (2007). Periodic Timetable Optimization in Public Transport. In: Waldmann KH., Stocker U.M. (eds.) *Operations Research Proceedings 2006. Operations Research Proceedings, Springer, Berlin, Heidelberg*
- Lokale Nahverkehrsgesellschaft Frankfurt am Main mbH (traffiQ) (2016b). *Fahrgaststromerhebungen (Nachfrageniveau Winter 2016)* [Data file: Querschnittsbelastung pro Linie]. Unpublished raw data.
- Lopez, Clélia; Leclercq, Ludovic; Krishnakumari, Panchamy; Chiabaut, Nicolas; van Lint, Hans (2017). Revealing the day-to-day regularity of urban congestion patterns with 3D speed maps. *Scientific Reports*, 7(1), 14029. doi:10.1038/s41598-017-14237-8.
- Lusby, Richard M.; Haahr, Jørgen Thorlund; Larsen, Jesper and Pisinger, David (2017). A Branch-and-Price algorithm for railway rolling stock rescheduling. *Transportation Research Part B: Methodological* 99, 228-250. doi:10.1016/j.trb.2017.03.003.
- Louwerse, Ilse and Huisman, Dennis (2014). Adjusting a railway timetable in case of partial or complete blockades. In: *European Journal of Operational Research*, 235(3), 583–593. doi:10.1016/j.ejor.2013.12.020.
- Marinov, Marin; Şahin, İsmail; Ricci, Stefano and Vasic-Franklin, Gordana (2013). Railway operations, time-tabling and control. *Research in Transportation Economics*, 41(1), 59-75.
- Martí, Rafael and Reinelt, Gerhard (2011). *The Linear Ordering Problem: Exact and Heuristic Methods in Combinatorial Optimization*. Berlin, Heidelberg: Springer Berlin Heidelberg.
- Martin, Ullrich, and Chu, Zifu (2013). *Direkte experimentelle Bestimmung der maximalen Leistungsfähigkeit bei Leistungsuntersuchungen im spurgeführten Verkehr: DFG-Forschungsvorhaben (MA 2326/6-1)*. Books on Demand, 2013.
- Mattsson, Lars-Göran and Jenelius, Erik (2015). Vulnerability and resilience of transport systems – A discussion of recent research. *Transportation Research Part A: Policy and Practice*, 81, 16-34. doi:10.1016/j.tra.2015.06.002.
- Meirich, Christian (2017). *Berechnung und Bewertung der Gesamtleistungsfähigkeit von Eisenbahnnetzen*. Doctoral Dissertation. Rheinisch-Westfälischen Technischen Hochschule Aachen, Aachen.
- Menius R., Matthews V. (2017). *Abnahme und Instandhaltung des Oberbaus*. In: *Bahnbau und Bahninfrastruktur*. Springer Vieweg, Wiesbaden
- Miao, J.; Yu, Y. and Wang, Y. (2010). A heuristic algorithm for the circulation plan of railway electrical motor units. In: *WIT Transactions on The Built Environment*, 114, 877-888.
- Michalewicz, Zbigniew and Fogel, David B. (2004). *How to Solve It: Modern Heuristics*. 2. Revised and Extended Edition. Berlin, Heidelberg: Springer.
- Milligan, Glenn W. and Cooper, Martha C. (1987). Methodology review: Clustering methods. *Applied psychological measurement*, 11(4), 329-354.

-
- Missikof, Michele (1997). An object-oriented approach to an information and decision support system for railway traffic control. *Engineering Applications of Artificial Intelligence*, 11, 25–40.
- Mladenović, Pavle (2019). *Combinatorics*. Cham: Springer International Publishing.
- Nakamura, Tatsuya; Hirai, Chikara and Nishioka, Yasuki (2011). A Practical Train Rescheduling Algorithm Using Three Predetermined Factors. In: *RailRome 2011. 4th International Conference on Railway Operations Modelling and Analysis (ICROMA), Rome, Italy, February 16th – 18th, 2011*.
- Neuber, Marco (2017). *Ein Beitrag zur operativen Zuglaufregelung unter besonderer Berücksichtigung vorausschauender Zugförderung bei der Umsetzung dispositiver Entscheidungen*. Doctoral Dissertation. Universität Stuttgart, Stuttgart.
- Newman, Peter and Kenworthy, Jeffrey (2015). *The End of Automobile Dependence. How Cities are Moving Beyond Car-Based Planning*. Washington. Island Press.
- Nie, Lei and Hansen, Ingo A. (2005). System analysis of train operations and track occupancy at railway stations. *European journal of transport and infrastructure research EJTIR*, 5(1), 31-54.
- Nielsen, Lars K. (2011). Rolling Stock Rescheduling in Passenger Railways: Applications in short-term planning and in disruption management. Doctoral Dissertation. Erasmus University Rotterdam, Rotterdam.
- Nielsen, Lars K.; Kroon, Leo; Maróti, Gábor (2012). A rolling horizon approach for disruption management of railway rolling stock. *European Journal of Operational Research*, 220(2), 496-509. doi:10.1016/j.ejor.2012.01.037.
- Oetting, Andreas (2002). *Angebotsabhängige Modellierung der reisezweckspezifischen Verkehrserzeugung und ihre Anwendung auf den städtischen Freizeitverkehr*. Doctoral Dissertation. Rheinisch-Westfälischen Technischen Hochschule Aachen, Aachen.
- Oetting, Andreas; Weidner, Tibor and Glienicke, Jan (2011). Automatic Rescheduling for Planning Processes. In: *RailRome 2011. 4th International Conference on Railway Operations Modelling and Analysis (ICROMA), Rome, Italy, February 16th – 18th, 2011*.
- Oetting, Andreas and Chu, Friederike (2013). Disruption Programs in Passenger Rail Transport — Ensuring Steady Operations During Disruptions. In: *13th World Congress on Transportation Research, WCTR2013, July 2013, Rio de Janeiro, Brasil*.
- Oetting, Andreas; Rittner, Michael and Fey, Sebastian (2013). Synchronal algorithms for determination and evaluation of conflict resolution scenarios for real-time rescheduling. In: *RailCopenhagen 2013. 5th International Conference on Railway Operations Modelling and Analysis (ICROMA), Copenhagen, Denmark, May 13th – 15th, 2013*.
- Oetting, Andreas and Griese, Sören (2016a). Entwicklung von Algorithmen für die Fahr- und Mindestzugfolgezeitenrechnung für Strecken. In: *25. VWT - Verkehrswissenschaftliche Tage 2016, Dresden*.
- Oetting, Andreas and Griese, Sören (2016b). *Konsistente Infrastruktur und Zugmodellierung für Makroskopische Untersuchungen (LeiZug)*. Technische Universität Darmstadt, Darmstadt, Unpublished manuscript.
- Oetting, Andreas (2019). *Bahnsysteme und Bahntechnik C - EBW(I): Eisenbahnbetriebswissenschaft, Einleitung*. Technische Universität Darmstadt, Darmstadt, [Lecture Presentation].

-
- O'Rourke, Thomas D. (2007) Critical Infrastructure, Interdependencies, and Resilience. *The Bridge*, 37, 22-29.
- Pachl, Jörn (2007). Avoiding Deadlocks in Synchronous Railway Simulations. In: *2nd International Seminar on Railway Operations Modelling and Analysis*. Hannover, Germany, March 28th – 30th, 2007.
- Pachl, Jörn (2018). *Systemtechnik des Schienenverkehrs. Bahnbetrieb planen, steuern und sichern*. 9., überarbeitete Auflage. Wiesbaden: Springer Vieweg.
- Paquete, Luis, and Stützle, Thomas (2006). A study of stochastic local search algorithms for the biobjective QAP with correlated flow matrices. *European Journal of Operational Research* 169, 3, 943-959.
- Pauley, Neil; Balcombe, Richard; Mackett, Roger; Titheridge, Helena; Preston, John; Wardman, Mark; et al. (2006). The demand for public transport: The effects of fares, quality of service, income and car ownership. *Transport Policy*, 13(4), 295-306. doi:10.1016/j.tranpol.2005.12.004.
- Peeters, Marc and Kroon, Leo (2003). Circulation of Railway Rolling Stock: A Branch-and-Price Approach. In: *ERIM Report Series Research in Management ERS-2003-055-LIS*, Erasmus Research Institute of Management (ERIM), Erasmus University and the Erasmus School of Economics (ESE) at Erasmus University, Rotterdam.
- Pellegrini, Paola; Marlière, Grégory and Rodriguez, Joaquin (2014). Optimal train routing and scheduling for managing traffic perturbations in complex junctions. *Transportation Research Part B: Methodological*, 59, 58-80. doi: 10.1016/j.trb.2013.10.013.
- Pender, Brendan; Currie, Graham; Delbosc, Alexa and Shiwakoti, Nirajan (2013). Disruption Recovery in Passenger Railways. *Transportation Research Record*, 2353(1), 22–32. doi:10.3141/2353-03.
- Pferdmenges, Sieglinde and Schaefer, Harald (1995). Automatische Konflikterkennung und wissensbasierte Konfliktlösung in der Streckendisposition. *Signal und Draht*, 87(5), 174-177.
- Piner, Daniel, and Condry, Benjamin (2017). International best practices in managing unplanned disruption to suburban rail services. *Transportation Research Procedia*, (25), 4403-4410.
- Potthoff, Gerhart (1969). Die Bedienungstheorie im Verkehrswesen. *Transpress, VEB Verlag für Verkehrswesen, Berlin*.
- Potthoff, Daniel; Huisman, Dennis and Desaulniers, Guy (2010). Column Generation with Dynamic Duty Selection for Railway Crew Rescheduling. *Transportation Science*, 44(4), 493-505. doi:10.1287/trsc.1100.0322.
- Radtke, Alexander and Hauptmann, Dirk (2004). Automated planning of timetables in large railway networks using a microscopic data basis and railway simulation techniques. *Advances in Transport*, 15, 615-625.
- Radtke, Alexander and Watson, Robert (2007). Railway simulation in the United Kingdom, *Railway Technical Review 2007*, 1, 24-28.
- Reggiani, Aura; Nijkamp, Peter and Lanzi, Diego (2015). Transport resilience and vulnerability: The role of connectivity. *Transportation Research Part A: Policy and Practice*, 81, 4-15. doi:10.1016/j.tra.2014.12.012

-
- Rhein-Main-Verkehrsverbund (RMV) (2016a). *RMV Frankfurt: Liniennetzplan – 2016*. Retrieved from: <https://www.rmv.de/c/de/linien-netze/streckennetz/rmv-liniennetzplaene/>
- Rhein-Main-Verkehrsverbund (RMV) (2016b). *RMV Frankfurt: Gesamtliniennetzplan – 2016*. Retrieved from: <https://www.rmv.de/c/de/linien-netze/streckennetz/rmv-liniennetzplaene/>
- Rinaldi, Steven M., Peerenboom, James P. and Kelly, Terrence K. (2001). Identifying, understanding, and analyzing critical infrastructure interdependencies. *IEEE control systems magazine*, 21(6), 11-25.
- Rodriguez, Joaquín (2007) A constraint programming model for real-time train scheduling at junctions. *Transportation Research Part B: Methodological*, 41(2), 231–245. doi: 10.1016/j.trb.2006.02.006.
- Şahin, Ismail (1999). Railway traffic control and train scheduling based on inter-train conflict management. *Transportation Research, Part B*, 33, 511–534.
- S-Bahn Berlin GmbH, (n.d.). *Auf einen Blick - Zahlen und Fakten*. Retrieved from: <https://sbahn.berlin/das-unternehmen/unternehmensprofil/s-bahn-berlin-auf-einen-blick/>, Last accessed on: 07.10.2019.
- Schipper, Danny and Gerrits, Lasse (2018). Differences and similarities in European railway disruption management practices. *Journal of Rail Transport Planning & Management*, 8(1), 42–55. doi:10.1016/j.jrtpm.2017.12.003.
- Schnieder, Lars (2015). *Betriebsplanung im öffentlichen Personennahverkehr*. Berlin, Springer-Verlag Berlin Heidelberg.
- Schrijver, Alexander (1993). Minimum Circulation of Railway Stock. *CWI Quarterly*, 6, 205-217.
- Schwanhäusser, Wulf (1974). Die Bemessung der Pufferzeiten im Fahrplangefüge der Eisenbahn. Doctoral Dissertation. Rheinisch-Westfälischen Technischen Hochschule Aachen, Aachen.
- Silla, Anne; Jaroszweski, David; Quinn, Andrew; Baker, Christopher; Hooper, Elizabeth; Kochsiek, Joachim and Schulz, Simon (2014). Guidebook for Enhancing Resilience of European Rail Transport in Extreme Weather Events. European Commission EC.
- Snelder, M.; Van Zuylen, H. J. and Immers L. H. (2012). A framework for robustness analysis of road networks for short term variations in supply. *Transportation Research Part A: Policy and Practice*, 46(5), 828-842.
- Sparing, Daniel, and Goverde, Rob MP. (2012). Identifying effective guaranteed connections in a multimodal network. *TRAIL Beta-Congress: Mobility and logistics-Science meets practice, Rotterdam, The Netherlands, 30-31 Oct. 2012. Trail Research School, 2012*.
- Steierwald, Gerd (2005). *Stadtverkehrsplanung. Grundlagen, Methoden, Ziele*. Berlin: Springer.
- Stelzer, Anselmo (2016). *Automatisierte Konfliktbewertung und -lösung für die Anschlussdisposition im (Schienen-)Personenverkehr*. Doctoral Dissertation. Technische Universität Darmstadt, Darmstadt.
- Stemer, Bastian (2018). *Entwicklung eines netzweiten Modells zur Konfliktidentifizierung und -charakterisierung im Kontext einer Störung des S-Bahn-Betriebs*. Master Thesis, Institut für Bahnsysteme und Bahntechnik, Technische Universität Darmstadt, Darmstadt.
- Sulyok, Istvan (2018). *Weiterentwicklung der Bewertung von Konfliktlösungs-Alternativen*. Master Thesis, Institut für Bahnsysteme und Bahntechnik, Technische Universität Darmstadt, Darmstadt.

- Tamvakis, Pavlos and Xenidis, Yiannis (2012). Resilience in Transportation Systems. *Procedia - Social and Behavioral Sciences*, 48, 3441-3450. doi:10.1016/j.sbspro.2012.06.1308.
- Törnquist, Johanna; Persson, Jan A. (2005). Train traffic deviation handling using Tabu Search and Simulated Annealing. In: *38th Annual Hawaii International Conference on System Sciences*.
- Thierens, Dirk, and Goldberg, David (1994). Convergence models of genetic algorithm selection schemes. In: *International Conference on Parallel Problem Solving from Nature*, 119-129. Springer, Berlin, Heidelberg.
- Tsubakitani, Shigeru and Evans, James R. (1998). Optimizing tabu list size for the traveling salesman problem. *Computers & Operations Research*, 25(2), 91-97.
- Tsuchiya, R.; Sugiyama, Y.; Yamauchi, K.; Fujinami, K.; Arisawa, R. and Nakagawa, T. (2006). Route-choice support system for passengers in the face of unexpected disturbance of train operations. In: *Proceedings of the 10th International Conference on Computer System Design and Operation in the Railway and Other Transit Systems (COMPRAIL'06)*, 189-197.
- UIC (2015). *Global Vision for Railway Development*. Retrieved from: <https://uic.org> › IMG › pdf › global_vision_for_railway_development. Last accessed on: 08.10.2019.
- UIC (2013). Code-406 – Capacity.
- Umbarkar, A. J., and Sheth, P. D. (2015). Crossover Operators in Genetic Algorithms: A Review. *ICTACT Journal on soft computing*, 6(1), 1083-1092. doi:10.21917/ijsc.2015.0150
- Vakhtel, Sergey (2002). *Rechnerunterstützte analytische Ermittlung der Kapazität von Eisenbahnnetzen*. Rheinisch-Westfälischen Technischen Hochschule Aachen, Aachen.
- Veelenturf, Lucas P.; Potthoff, Daniel; Huisman, Dennis and Kroon, Leo G. (2012). Railway crew rescheduling with retiming. *Transportation Research Part C: Emerging Technologies*, 20(1), 95-110. doi:10.1016/j.trc.2010.09.008.
- Veelenturf, Lucas P.; Kidd, Martin P.; Cacchiani, Valentina; Kroon, Leo G. and Toth, Paolo (2016). A Railway Timetable Rescheduling Approach for Handling Large-Scale Disruptions. *Transportation Science*, 50(3), 841–862. doi: 10.1287/trsc.2015.0618.
- Verband Deutscher Verkehrsunternehmen (VDV) (2016). *VDV-Statistik 2016*. Retrieved from: <https://www.vdv.de/statistik-jahresbericht.aspx>.
- Verband Deutscher Verkehrsunternehmen (VDV) (2018). *VDV-Schrift 457 – Automatische Fahrgastzählssysteme*. Verband Deutscher Verkehrsunternehmen, Köln.
- Verband Deutscher Verkehrsunternehmen (VDV) (2001). *VDV-Schrift 4 – Verkehrserschließung und Verkehrsangebot im ÖPNV*. Verband Deutscher Verkehrsunternehmen, Köln.
- Verkehrs- und Tarifverbund Stuttgart GmbH (VVS) (2016a). *Stadtbahn-Liniennetz - 2016*. Retrieved from: <https://www.vvs.de/karten-plaene/liniennetz/>
- Verkehrs- und Tarifverbund Stuttgart GmbH (VVS) (2016b). *Bus-Liniennetz Esslingen - 2016*. Retrieved from: <https://www.vvs.de/karten-plaene/liniennetz/>
- Verkehrs- und Tarifverbund Stuttgart GmbH (VVS) (2016c). *Bahn- und Busnetz Ludwigsburg - 2016*. Retrieved from: <https://www.vvs.de/karten-plaene/liniennetz/>
- Verkehrs- und Tarifverbund Stuttgart GmbH (VVS) (2016d). *Verkehrstromerhebungen 2010-2016 (Nachfrageniveau Herbst 2016)* [Data file: Linienbelastung verschiedene Linien]. Unpublished raw data.

-
- Verkehrs- und Tarifverbund Stuttgart GmbH (VVS) (2016e). *Verkehrslinienplan Stuttgart - 2016*. Retrieved from: <https://www.vvs.de/karten-plaene/liniennetz/>
- Verkehrs- und Tarifverbund Stuttgart GmbH (VVS) (2016f). *02 Verkehrslinienplan Esslingen (N) / Plochingen - 2016*. Retrieved from: <https://www.vvs.de/karten-plaene/liniennetz/>
- Verkehrs- und Tarifverbund Stuttgart GmbH (VVS) (2017). *S-Bahn-Liniennetz - 2017*. Retrieved from: <https://www.vvs.de/karten-plaene/liniennetz/>
- Verkehrsgesellschaft mbH (ESWE) (2016a). *Liniennetzplan 2016 (schematisch)*. Retrieved from: <https://www.eswe-verkehr.de/netz.html?app=>
- Verkehrsgesellschaft mbH (ESWE) (2016b). *Fahrgastzahlen (Nachfrageniveau 2016)* [Data file: Anzahl der ein- und aussteigenden Passagiere pro Linie]. Unpublished raw data.
- Verkehrsgesellschaft mbH (ESWE) (2016c). *Liniennetzplan 2016 (geografisch)*. Retrieved from: <https://www.eswe-verkehr.de/netz.html?app=>
- Wagenaar, Joris; Kroon, Leo and Fragkos, Ioannis (2017). Rolling stock rescheduling in passenger railway transportation using dead-heading trips and adjusted passenger demand. *Transportation Research Part B: Methodological*, 101, 140-161. doi:10.1016/j.trb.2017.03.013.
- Wakob, H. (1985). *Ableitung eines generellen Wartemodells zur Ermittlung der planmäßigen Wartezeiten im Eisenbahnbetrieb unter besonderer Berücksichtigung der Aspekte Leistungsfähigkeit und Anlagenbelastung*. Doctoral Dissertation, Rheinisch-Westfälischen Technischen Hochschule Aachen, Aachen.
- Walther, Klaus (1973). *Nachfrageorientierte Bewertung der Streckenführung im öffentlichen Personennahverkehr*. Doctoral Dissertation. Rheinisch-Westfälischen Technischen Hochschule Aachen, Opladen.
- Walther, Klaus (1991). Maßnahmenreagibler Modal-Split für den städtischen Personenverkehr – Theoretische Grundlagen und praktische Anwendung. In: *Veröffentlichungen des Verkehrswissenschaftlichen Instituts der Rheinisch-Westfälischen Technischen Hochschule Aachen*, 45, Aachen. isbn:0176-9359.
- Wegele, S. and Schnieder, E. (2004). Automated dispatching of train operations using genetic algorithms. In: *WIT Transactions on The Built Environment*, 74, 774-784.
- Wende, Dietrich (2003). *Fahrdynamik des Schienenverkehrs*. Wiesbaden: Vieweg + Teubner Verlag.
- Wendler, Ekkehard, and Nießen, Nils (2005). Infrastrukturmodellierung für die strategische Netzplanung. In: *20. Verkehrswissenschaftliche Tage, Dresden*.
- Xu, Xiangdong; Chen, Anthony; Jansuwan, Sarawut; Heaslip, Kevin and Yang, Chao (2015). Modeling Transportation Network Redundancy. *Transportation Research Procedia*, 9, 283-302. doi:10.1016/j.trpro.2015.07.016.
- Yaacoub, Charles; Farah, Joumana and Pesquet-Popescu, Béatrice (2009). Improving hash-based Wyner-Ziv video coding using genetic algorithms." In: *5th international ICST mobile multimedia communications conference*, 30, ICST (Institute for Computer Sciences, Social-Informatics and Telecommunications Engineering).
- Yin, Haodong; Baoming, Han; Dewei, Li; Jianjun, Wu and Huijun, Sun (2016). Modeling and simulating passenger behavior for a station closure in a rail transit network. *PLoS one*, 11(12), e0167126-e0167126.

-
- Yuan, Jianxin (2006). *Stochastic Modelling of Train Delays and Delay Propagation in Stations*. Doctoral Dissertation. Technische Universiteit Delft, Delft.
- Zadeh, L. A. (1965). Fuzzy sets. *Information and control*, 8(3), 338-353.
- Zeng, Amy Z.; Durach, Christian F. and Fang, Yan (2012). Collaboration decisions on disruption recovery service in urban public tram systems. *Transportation Research Part E: Logistics and Transportation Review*, 48(3), 578-590. doi:10.1016/j.tre.2011.11.005.
- Zilko, Aurelius A.; Kurowicka, Dorota and Goverde, Rob MP. (2016). Modeling railway disruption lengths with Copula Bayesian Networks. *Transportation Research Part C: Emerging Technologies*, 68 350-368.
- Ziyou, Gao and Song, Yifan (2002) A reserve capacity model of optimal signal control with user-equilibrium route choice. *Transportation Research Part B: Methodological*, 36(4), 313-323.

Table of Figures

Figure 1.1 Overview of possible disruptions for critical infrastructures and railway operations (Dorbritz and Weidmann, 2012, as cited in Chu 2014)	4
Figure 2.1 General approach for railway operations research calculations (Oetting 2019, modified by author)	8
Figure 2.2 General example of a cyclic schedule, including the cycle time and service interval (source: Hansen and Pachl, 2014, modified by author)	10
Figure 2.3 Overview of the fundamental conflict types (Pferdmenges and Schaefer 1995, as cited in Oetting 2019; modified by author)	18
Figure 2.4 Relation between waiting time and capacity (Hansen and Pachl 2014, p.284).....	30
Figure 2.5 Phases of the planned Disruption-management approach (Chu and Fornauf 2011, as cited in Chu and Oetting 2013).....	44
Figure 2.6 Phases within planned disruption-management (by author)	45
Figure 2.7 Monocentric and Mono-polycentric Urban Landscapes (Lefèvre 2009, modified by author)	58
Figure 2.8 Top: Spatial arrangement of Lines; Bottom: Composite Network forms (Schnieder 2015; modified by author).....	62
Figure 2.9 Existing research voids within planned disruption-management (by author)	66
Figure 3.1 Structure of the dynamic DRP deployment system (by author)	92
Figure 3.2 Example of the core area of a commuter railway network (Kremer und Rink 2016) .	98
Figure 3.3 Example of a negative turn (by author)	104
Figure 3.4 Example of a positive turn (by author)	104
Figure 3.5 Example of corresponding lines (Stemer 2018, modified by author).....	106
Figure 3.6 Example of two different critical areas and a complete (A) as well as a partial blockage (B) (by author)	116
Figure 3.7 Example of positive and negative turn residuals (by author)	118
Figure 3.8 Structure of the document (by author)	124
Figure 4.1 Assumed interplay between scheduled capacity and public transport demand (Crespo and Oetting 2018, modified by author).....	131
Figure 4.2 Route-base occupancy rate (OR) of a public transport vehicle expressed as a function of the spatiotemporal changes of demand (by author)	132
Figure 4.3 Assessed public transport lines within every public transport network: a. Hamburg (HVV 2016a); b. Stuttgart (VVS 2016a); c. Frankfurt a.M. (RMV 2016a); d. Wiesbaden (ESWE 2016a); e. Esslingen (VVS 2016b); f. Ludwigsburg (VVS 2016c).....	139

Figure 4.4 Schematic representation of the decisive cross-sections and the location of the mobility center of gravity for every assessed public transport network: a. Hamburg (HVV 2016c); b. Stuttgart (VVS 2016e); c. Frankfurt a.M. (RMV 2016b); d. Wiesbaden (ESWE 2016c); e. Esslingen (VVS 2016f); f. Ludwigsburg (VVS 2016c), all modified by author.	144
Figure 4.5 Summarized passenger flow at the decisive cross-sections for all assessed Stuttgart's light rail lines (by author)	146
Figure 4.6 Temporal category clusters for Stuttgart's light rail lines (by author)	147
Figure 4.7 Summarized temporal clusters for Stuttgart's light rail lines (by author)	147
Figure 4.8 Air distances measured from all neighbouring public transport stops to the mobility center of gravity for Stuttgart's light rail lines "U9" and "U14" (by author)	148
Figure 4.9 Averaged OR for all assessed lines and modes of transport for every temporal category (by author).....	152
Figure 4.10 Results from the function fitting process: Fitted OR function for all assessed modes across the three temporal categories (by author)	153
Figure 4.11 Public transport mode specific OR function within a railway disrupted situation (by author).....	156
Figure 4.12 Flow chart for estimating the residual capacity (by author).....	157
Figure 4.13 Example of the modelling of the railway and public transport networks (by author)	158
Figure 4.14 Example of the modelling of the railway and public transport lines (by author)	159
Figure 4.15 Example of the integration of the disruption relevant information (by author)	160
Figure 4.16 Example of the identification of relevant public transport lines (by author)	161
Figure 4.17 Example of the establishment of the evaluating route length and the total route length vis-à-vis the mobility center of gravity (by author).....	163
Figure 4.18 Stuttgart's S-Bahn Lines S1, S2 and S3 around the Disrupted Area (VVS 2017; modified by author)	165
Figure 4.19 Example of the implementation of the proposed modelling framework in a disrupted scenario (by author)	165
Figure 5.1 Enhanced macroscopic infrastructural node-link model (by author).....	171
Figure 5.2 Node elements: example of a matrix of reachability (Matrix E) for in and outflows of trains (by author)	172
Figure 5.3 Examples of the differentiation of lines between sides in correspondence to their DRP operating Concept and the magnitude of the disruption (by author).....	176
Figure 6.1 Example of the transference of passengers' waiting time after the cancellation of a train service (by author)	218

Figure 6.2 Example for the transference of passengers' waiting time of the first cancelled service after the cancellation of the linked service (by author).....	219
Figure 6.3 Bundle of elemental conflict solution alternatives for vehicle availability conflicts arranged in a hierarchical structure (by author).....	224
Figure 6.4 Bundle of elemental conflict solution alternatives for reachability conflicts (by author)	226
Figure 6.5 Elemental conflict solution alternatives for occupancy and infrastructure availability conflicts (by author)	229
Figure 6.6 Bundle of elemental conflict solution alternatives for circulation conflicts (by author)	229
Figure 7.1 Logical structure for the enhanced clustering of trains (by author)	239
Figure 8.1 Relevant determining variables to be considered during their identification and classification of each of the line-specific conflict types (by author)	243
Figure 8.2 Structured approach for the identification, classification and sorting of line-specific conflicts (by author)	247
Figure 8.3 Coding utilized for the classification process of every identified vehicle availability conflict (by author).....	253
Figure 8.4 Hierarchy of elemental conflicts solution alternatives for a lack of vehicle availability (by author)	253
Figure 8.5 Hierarchy of elemental conflicts solution alternatives for a surplus of vehicle availability (by author)	259
Figure 8.6 Example of the identification of reachability conflicts (by author)	265
Figure 8.7 Coding utilized for the classification process of every identified reachability conflict (by author)	266
Figure 9.1 Structured approach for the systematic development of PVSCS for every train in the network (by author)	280
Figure 9.2 General example for the establishment of the investigation order for every train (by author)	282
Figure 9.3 General example for Isolating Potential Transition Train Services for a train (by author)	289
Figure 9.4 Example of turn residuals after early turning an investigated train: A. Positive turn residuals; B. Negative turns with delay; C. Negative turn on-time (by author)	305
Figure 9.5 Examples of the ability to reduce the delay: A. Complete reduction of the delay at the end station; B. Complete reduction of the delay after an early turn; C. Reduction by an exchange of the train service at the end station (by author)	308

Figure 10.1 Importance of the Infrastructure layout around the LtfTS: A. Generic types of infrastructure layouts; B. Example of the handling of train entrance sequences to the LtfTS for an infrastructure layout type 2 (by author).....	316
Figure 10.2 Example of the dynamic junction rescheduling problem for nine trains; the colours and numbers represent the sequence constraints between trains on each link connected to the junction (Fan et al. 2012; modified by author)	319
Figure 10.3 Heuristic for amending unfeasible train sequences (Fan et al. 2012; modified by author).....	321
Figure 10.4 Structured approach for the combination and handling of PVSCS (by author)	323
Figure 10.5 Structure of a Tabu Search algorithm for the establishment of the best entrance sequence of potentially queuing trains to the LtfTS (by author)	329
Figure 10.6 Example of an initial entrance sequence of all potentially queuing trains to the LtfTS based on FCFS principle and abiding by the sequence restrictions per incoming link to the LtfTS (by author)	332
Figure 10.7 Example of the swapping of train pairs in the current sequence for the establishment of a new entrance sequence of potentially queueing trains to the LtfTS (by author).....	336
Figure 10.8 Structure of a Tabu Search Algorithm based on a selection of elite and non-elite moves for the establishment of the best entrance sequence of potentially queuing trains to the LtfTS (by author).....	339
Figure 10.9 Flowchart diagram of a basic genetic algorithm (Yaacoub et al. 2009, modified by author).....	341
Figure 10.10 Structure of a Genetic algorithm for the development and handling of PVSCS combinations towards the establishment of the strived conflict-free schedules (by author)	342
Figure 10.11 Single (A) and two-point (B) cross-over technique implemented on a pair of PVSCS combinations (by author)	349
Figure 11.1 Structure of an automatic CDCR process relying on predefined elemental conflicts solution alternatives (by author)	359
Figure 12.1 Structure for evaluating the effect on the operating situation of conflicts resolution alternatives, as part of an automatic CDCR process (by author).....	407
Figure 12.2 Structure for evaluating the fitness of every conflict-free PVSCS combination as part of the dynamic DRP deployment system (by author)	409
Figure 12.3 Proposed conflict severity weighting functions (by author)	424
Figure 12.4 Changes in the slope of different linear conflict severity weighting functions for different disruption lengths and calibrating times (by author)	425
Figure 12.5 Induced changes in capacity consumption (by author)	440

Figure 13.1 General approach for adjusting the conflict-free schedules and selecting the one to constitute the proposed solution of the dynamic DRP deployment system (by author)	457
Figure 13.2 Proposed approach for Adjusting the Conflict-free schedule through the removal of unnecessary measures (by author)	460
Figure 14.1 Network of the S-Bhan Rhein-Main (DB Regio AG 2016, modified by author)	481
Figure 14.2 Traffic diagram depicting the handling of a disruption with a total blockage in the tunnel area of the S-Bhan Rhein-Main network (DB Regio AG 2017)	482
Figure 14.3 Affected section and critical area (Kremer and Rink 2016, modified by author)....	483
Figure 14.4 Example of a DRP operating concept (Kremer and Rink 2016, modified by author)	484
Figure 14.5 Example for the identification and flagging of second-order elements (by author)	487
Figure 14.6 General example depicting the isolation of accessible infrastructural elements (by author)	503
Figure 14.7 General example depicting the node-to-node development of a PVSCS (by author)	508
Figure 14.8 General example depicting the node-to-node development of a PVSCS with shunting movements (by author)	509
Figure 14.9 Infrastructure model between stations Frankfurt Messe (FFME) and Frankfurt Hbf – Tief (FFT), including Frankfurt Galluswarte (FFGA) (by author).....	520
Figure 14.10 General example of an occupancy conflict in a link within the critical area (by author)	520
Figure 14.11 Example for the identification of service conflicts (by author)	524
Figure 14.12 General example of an implementation of a conflict resolution alternative and identification of follow-up conflicts (by author)	531
Figure 14.13 General example of a conflict-free PVSC combination with unnecessary measures (by author)	536
Figure 14.14 General example of the adjustment of conflict-free PVSC combination with unnecessary measures (by author)	538

Table of Tables

Table 2.1 Model Trains (by author)	13
Table 2.2 Recommended additional time rates per infrastructural element in UIC Code-406 (UIC 2013, p.30; modified by Author)	31
Table 2.3 Recommended limits for the capacity consumption in UIC Code-406 (UIC 2013, p.30-31; modified by Author)	32
Table 2.4 List of all elemental dispatching measures available for the development of DRPs (Chu et al. 2012, Chu and Oetting 2013, Oetting and Chu 2012, and Brauner 2019)	47
Table 2.5 Average maximum passenger hauling capabilities per vehicle type (standing and sitting) (Dorbritz and Anderhub 2007)	60
Table 3.1 Unaffected research voids within DRP Development and Deployment (by author)	68
Table 4.1 Isolated key determining variables influencing the estimation of the residual capacity (by author).....	126
Table 4.2 Annual overview of the transport structures across the six assessed public transport networks (VDV 2016).....	137
Table 4.3 Annual overview of the public transport modes across the six assessed public transport networks (VDV 2016).....	137
Table 4.4 Assessed public transport networks, lines, modes and data set sources (by author) ..	140
Table 4.5 Surveyed stops per every assessed line - Frankfurt a.M. Light Rail (traffiQ 2016)	140
Table 4.6 Passengers transported between stops - Stuttgart's light rail line "U4" direction "Hölderlinplatz" (VVS 2016d)	141
Table 4.7 Daily passenger flows per stop - Stuttgart's light rail line "U14" for both directions of travel (by author).....	143
Table 4.8 Daily passenger flows at the decisive cross-sections for all assessed lines - Stuttgart's light rail (by author)	145
Table 4.9 Example of the iterative clustering process for a single interval - Stuttgart's light rail (by author).....	146
Table 4.10 Identification of the mobility Center of gravity - Stuttgart's light rail (by author) ...	148
Table 4.11 Normalized distance - Stuttgart's light rail line "U9" for both directions of travel (by author).....	149
Table 4.12 Referenced journey-specific OR Development - Stuttgart's light rail line "U4" direction "Hölderlinplatz" (by author).....	150
Table 4.13 Averaged journey-specific OR - Stuttgart's light rail line "U4" direction "Hölderlinplatz" (by author).....	151

Table 4.14 Example of the estimation of the residual capacity for Stuttgart’s light rail lines U4 and U14 during the HVZ (by author).....	166
Table 6.1 Summary of the fourteen elemental conflict solution alternatives examined throughout subsection 6.3 to address conflicts across the line-specific and vehicle-specific operational levels (by author)	221
Table 6.2 Summary of the eight elemental conflict solution alternatives to address line-specific conflicts (by author)	222
Table 6.3 Summary of the eight elemental conflict solution alternatives to address vehicle-specific conflicts (by author)	227
Table 8.1 Solution-oriented classification scheme for vehicle availability conflicts with a lack of trains (by author)	254
Table 8.2 Solution-oriented classification scheme for vehicle availability conflicts with a surplus of trains (by author)	260
Table 8.3 Solution-oriented classification scheme for Reachability conflicts (by author)	267
Table 12.1 Summary of the handling of the ten determining variables identified from the examination of the predefined elemental conflict solution alternatives across both line-specific and vehicle-specific operational levels in correspondence to existing approaches (by author)	404
Table 12.2 Supplement transition times (by author)	418
Table 12.3 Summary of the handling of the ten determining variables identified from the examination of the predefined elemental conflict solution alternatives across both line-specific and vehicle-specific operational levels within the assessment module (by author)	452
Table 14.1 Line-Specific measures contained in the chosen DRP operating concept (Kremer and Rink 2016 – see Figure 14.4)	484
Table 14.2 Actual position of all trains of line S5 (by author).....	488
Table 14.3 Example for the clustering of train categories (by author)	490
Table 14.4 Example of vehicle availability conflicts (by author)	492
Table 14.5 Example of the establishment of the earliest projected arrival at the LtFTS or DRP relevant infrastructural element (by author)	497
Table 14.6 Example of a sorted line-specific conflict list (by author)	498
Table 14.7 Example of the establishment of the projected arrival of trains to the LtFTS or DRP relevant infrastructural element on one side of a disruption divided network (by author)	500
Table 14.8 Example of the allocation of the investigation order for all trains on one side of a disruption divided network (by author)	501
Table 14.9 Example of the establishment of potentially queuing trains per incoming link (by author)	515

Table 14.10 Example of the identification of occupancy conflicts in links (by author)	521
Table 14.11 Example of a negative shift in time to support the early removal of a train from the LtfTS (by author)	528
Table 14.12 Example of the assessment of “probable” conflict resolution alternatives for the establishment of the conflict severity (by author)	534
Table 14.13 Example of the assessment of conflict resolution alternatives (by author).....	535
Table 14.14 Potentially unnecessary measures in a conflict resolution (by author)	537

Table of Symbols and Variables

Section 1 - Model for Estimating the Public Transport Residual Capacity

A	Set of all public transport stops
$Ad \in A$	Subset of public transport stops around stations in the subset Yd
$a \in A$	Public transport stop
B	Set of all links between nodes
$b \in B$	Public transport link, representing the actual route
C_j	Capacity of a public transport mode j
C_{i,l_j,dir_s}	Scheduled Capacity of a specific public transport line l_{j,dir_s} at a time of day i
$CC \in A$	Subset of public transport stops around the element CBD
CBD	Mobility center of gravity
DRP	Set of all DRP transport concepts under assessment
$e_{a,y}$	Nexus between the public transport stop a and a commuter railway station y
f	(Minimum) headway time or frequency
f_{i,l_j,dir_s}	Frequency at a certain time of day i for a line l_{j,dir_s}
L	Set of all public transport lines
$l_{j,dir_s} \in L$	Public transport line of a public transport mode j with a direction of travel s
$Ld \in L$	Subset of public transport lines serving as the link between disrupted locations Ad and CC or detailed in the transport concept DRP
$Ld_{a_o,y_w} \in L$	Subset of public transport lines for rerouting passengers at a commuter railway station y_n through a public transport stop a_o
l_H	Air distance measured between the stop and the center of gravity
$OR_{j,n}$	Occupancy rate of a public transport mode j assessed at a point n
$RC_{j,n}$	Residual capacity of a public transport mode j at a point n
$RC_{i,l_j,dir_s,d}$	Residual capacity at a certain time of day i , for a particular public transport line l_{j,dir_s} at a normalized evaluating distance d_{l_j,dir_s}
$RC_{a_o,y_w,j,i}$	Residual capacity of a public transport mode j , at a public transport stop a_o connected to the commuter railway station y at a certain time of the day i
$RC_{y_w,j,i}$	Residual capacity of a public transport mode j , at a time of the day i , available at each rerouting commuter railway station y

t_{def}	Defined time period
$TotRC_{y,w,i}$	Total residual capacity at station y for all the modes at a time of the day i
U_F	Detour factor
Vc	Maximum vehicle capacity
Vc_{i,l_j,dir_s}	Vehicle capacity (sitting & standing places) at a certain time of the day i for line l_j,dir_s
Y	Set of all commuter railway stations
$Yd \in Y$	Subset of commuter railway stations y where passenger rerouting strategies are planned
$y \in Y$	Commuter railway station
Z	Set of all links between commuter railway stations
$z \in Z$	Commuter railway links, representing the actual route

Section 2 – Dynamic DRP Deployment System

$AR(I_{S,o})_k$	Adjusted fitness of conflict-free PVSCS combination $I_{S,o}$ with sub-index k
$a_{T_{l_S,i}^h - T_{l_S,j}^r}$	Difference in the scheduled arrival time to the last technically feasible turning station (LtfTS) for a pair of potentially queuing trains $T_{l_S,i}^h - T_{l_S,j}^r$
C_f	Identified conflict C with sub-index f
C_f'	Identified follow-up conflict C' with sub-index f
$C_f'_{RS_{C_f}^Y}$	Follow-up conflict identified after the projected implementation of conflict resolution alternative $RS_{C_f}^Y$
DV_i	Determining variable with sub-index i in the evaluation function
D	Superset containing the set D_{l_S} of PVSCS for all trains circulating in the network
D_{l_S}	Superset containing the set $D_{T_{l_S,i}}$ of PVSCS for all trains servicing line l_S
$D_{T_{l_S,i}}$	Set of PVSCS for train $T_{l_S,i}$
$d_{T_{l_S,i}}$	Potential Vehicle-Specific Conflict Solution in Time and Space (PVSCS) for train $T_{l_S,i}$
ES	Parameter for the establishment of the elite conflict-free PVSCS combinations in the converging generation of the Genetic algorithm
f_{DRP,l_S}	Frequency of service for the DRP operating concept of a line l_S
F	Number of PVSCS combinations in every generation of the Genetic algorithm

F'	Number of elite conflict-free PVSCS combinations in the converging generation of the Genetic algorithm
G_{l_S}	Set of Green clustered trains for line l_S
$G + l_S$	Set of Green+ clustered trains for line l_S
H	Total number of potentially queuing trains handled by the Tabu Search algorithm
H_q	Total number of potentially queuing trains per incoming link q
h	Fixed entrance sequence of all potentially queuing trains to the last technically feasible turning station (LtfTS) following a First Come First Served (FCFS) principle (i.e. initial situation)
$I_{S,o}$	PVSCS combination I on side S with a sub-index o
$I_{S,o}'$	PVSCS combination I on side S with a sub-index o product of the crossover within the Genetic algorithm and prior to the verification of its operational compatibility
i	Investigation order for the development of line-specific conflict resolution alternatives
J	Set of all lines that constitute the commuter railway network
$K_{\omega S_a}$	Conflicting route through switching zone ω in station S_a
$L_{C_{I_{S,o}}}$	List of all vehicle-specific conflicts for during the fixing of PVSCS combination $I_{S,o}$
$L_{CW_{I_{S,o}}}$	List of ranked train swaps that can be executed by the Tabu Search algorithm for a PVSCS combination $I_{S,o}$
$L_{P_{I_{S,o}}}$	Short-term Tabu list for a PVSCS combination $I_{S,o}$
$L_{P_{I_{S,o}}}^{Elite}$	Subset of elite train swaps in the short-term Tabu list $L_{P_{I_{S,o}}}$
$L_{P_{I_{S,o}}}^{N-Elite}$	Subset of non-elite train swaps in the short-term Tabu list $L_{P_{I_{S,o}}}$
$L_{U_{I_{S,o}}}$	Long-term Tabu list for a PVSCS combination $I_{S,o}$
$l_{Un} \in J$	Line in the commuter railway network not affected by the disruption
$l \in J$	Line in the commuter railway network affected by the disruption
$l^c \in J$	Line in the commuter railway network with a corresponding line c
$l_S \in J$	Line in the commuter railway network for side S
MT	Model train
m_1	Slope of the linear function utilized as a parameter to calibrate the weighting of the conflict severity

m_2	Parameter utilized to calibrate the exponential function utilized for the weighting of the conflict severity
NC_f	Unnecessary measure within a conflict resolution
$NL_{NC_{I_{S,o}}}$	List of unnecessary measures for a conflict-free PVSCS combination $I_{S,o}$
$NR(I_{S,o})'$	Partial fitness of the conflict resolutions utilized to address all follow-up conflicts induced by the removal of an unnecessary measure during the adjustment of a conflict-free PVSCS combination $I_{S,o}$
$NR(NC_f)$	Positive fitness attained by removing the unnecessary measure NC_f within a conflict resolution
n_T	Required number of trains to service a cyclic schedule
n_{R,DRP,l_S}	Required number of trains to service the DRP operating concept of line l_S
n_{A,l_S}	Number of available trains in the actual disrupted situation for line l_S
n_{C,l_S}	Number of conflicting trains (i.e. vehicle availability) for line l_S
n_{C,l_S}^c	Number of trains that can be exchanged from a surplus corresponding line l_S^c
n'_{C,l_S}	Resulting number of trains for the investigated line during the processes of classification of vehicle availability conflicts for line l_S
n_{CT,l_S}	Number of trains that can be coupled in line l_S
n_{DC,U,l_S}	Number of trains that can be decoupled in line l_S
n_{E,l_S}	Number of trains that can be parked at conventional parking locations in line l_S
n_{E,U,l_S}	Number of trains that can be parked at unconventional parking locations in line l_S
n_{F,l_S}	Number of trains that can be transferred from the opposite side of a divided line l_S
$n_{G_{l_S}}$	Number of trains in the Green cluster G_{l_S} of line l_S
$n_{G^+_{l_S}}$	Number of trains in the Green+ cluster $G^+_{l_S}$ of line l_S
n_{P,l_S}	Number of service available vehicle compositions at parking locations that fit with the requirements for the train services in the original schedule of line l_S
n_{P,U,l_S}	Number of service available vehicle compositions at parking locations that do not fit with the requirements for the train services in the original schedule of line l_S
$n_{Y_{l_S}}$	Number of trains in the Yellow cluster Y_{l_S} of line l_S
OS_{Proj}	Actual operating situation
$OS_{Proj-RS_{C_f}^Y}$	Operating situation induced by the projected implementation of a conflict resolution alternative $RS_{C_f}^Y$

$P_{I_{S,o}}$	Total number of possible train swaps that can be executed by the Tabu Search algorithm for a PVSCS combination $I_{S,o}$
Pt_{S_a}	Platform track in station S_a
q	Incoming link to the last technically feasible turning station (LtfTS)
R^*	Fitness of the incumbent solution of the Tabu Search algorithm
$R(I_{S,o})$	Fitness of a conflict-free (i.e. fixed) PVSCS combination $I_{S,o}$
$R(I_{S,o})'$	Partial fitness of a conflict-free (i.e. fixed) PVSCS combination $I_{S,o}$
$R(I_{S,o})_k$	Fitness of a conflict-free (i.e. fixed) PVSCS combination $I_{S,o}$ with sub-index k
$R(RS_{C_f})$	Assessed effect of a conflict resolution RS_{C_f} on the operating situation
$R(RS_{C_f}^{\gamma Se})$	Assessed effect of a “probable” conflict resolution alternatives for the establishment of the severity Se of a conflict C_f
$R\left(RS_{C_f' RS_{C_f}^{\gamma Se}}^{\gamma Se}\right)$	Assessed effect of a “probable” conflict resolution alternatives to establish the severity Se of a follow-up conflict C'_f identified after the projected implementation of conflict resolution alternative $RS_{C_f}^{\gamma}$
R_{l_S}	Set of Red clustered trains for line l_S
$R + l_S$	Set of Red + clustered trains for line l_S
$RS_{C_f}^{\gamma}$	Conflict resolution alternative with super index γ to resolve conflict C_f
RS_{C_f}	Chosen conflict resolution to resolve conflict C_f
$RS_{C_f}^{\gamma Se}$	“Probable” conflict resolution alternative with super index γ to establish the severity Se of conflict C_f
$RS_{C_f' RS_{C_f}^{\gamma Se}}^{\gamma Se}$	“Probable” conflict resolution alternative with super index γ to establish the severity Se of a follow-up conflict C'_f identified after the projected implementation of conflict resolution alternative $RS_{C_f}^{\gamma}$
r_T	Number of trains scheduled to utilize a platform track within the defined time period
rc_{l_S}	Set of reachability conflicts for line l_S
S	Side of an affected line
SE_{C_f}	Severity of a conflict C_f

$SE_{C_f'RS_{C_f}^Y}$	Severity of a follow-up conflict C'_f identified after the projected implementation of conflict resolution alternative $RS_{C_f}^Y$
Se_{C_f}	Set of “probable” conflict resolution alternatives $RS_{C_f}^{Yse}$ for the establishment of the severity of a conflict C_f
$Se_{C_f'RS_{C_f}^Y}$	Set of “probable” conflict resolution alternatives $RS_{C_f'RS_{C_f}^Y}^{Yse}$ for the establishment of the severity of a follow-up conflict C'_f identified after the projected implementation of conflict resolution alternative $RS_{C_f}^Y$
$Sol_{I_{S,o}}$	Set of chosen conflict resolutions for PVSCS combination $I_{S,o}$
T_{l_S}	Train T servicing line l on side S
$T_{l_S,i}$	Train T servicing line l on side S with an investigation order i
$T_{l_S,i}^h$	Potentially queuing train T servicing line l on side S with an investigation order i and an initial entrance sequence h
Trc_{l_S}	Train service generating a reachability conflict on line l_S
t_A	Inter-arrival time
\bar{t}_A	Mean inter-arrival time
t_{Ad}	Additional time rate according to UIC Code-406
t_{an}	Approach time
t_B	Service time (i.e. minimum headway time)
\bar{t}_B	Mean service time
t_{C_f}	Temporal occurrence of conflict C_f registered in the CDCR process
$t_{C_f}^{u.c}$	Temporal occurrence of conflict $C_f^{u.c}$ addressed by the conflict resolution alternative $RS_{C_f}^Y$ under consideration
$t_{Dis_{C_f-C_f}^{u.c}}$	Temporal distance between conflict C_f and the conflict $C_f^{u.c}$ addressed by conflict resolution alternative $RS_{C_f}^Y$ under consideration
t_{cal}	Calibrating time utilized to calibrate the functions for the weighting of the conflict severity
t_C	Cycle time in a cyclic schedule
t_{CDRP,l_S}	Cycle time of a line l_S for a DRP operating concept
$t_{CDRP,l_S,\psi}$	Cycle time within the DRP operating concept for line l_S for a cycle variant ψ

t_{Comm}	Communication time of a dispatching measure between staff members
$t_{Comm.Pass}$	Communication time to passengers
t_{Couple}	Coupling time between train services
$t_{Decouple}$	Decoupling time of a vehicle composition
$t_{FD,\vartheta T_{l_s,i}}$	Time at which vehicle ϑ in the vehicle composition appointed to train $T_{l_s,i}$ finalized its duties
t_{def}	Defined time period
t_{EDL}	Estimated disruption length
t_f	Journey time
t_{f,TS_x-TS_y}	Journey time between turning station TS_x and TS_y
t_{fa}	Release time
t_{fb}	Route setting time
t_{kn}	Journey time in common route selection within a node
$t_{kn,arr}$ track	Journey time between the home signal and the stopping position at the platform track
$t_{kn,dep}$	Journey time between the stopping position at the platform track and the clearing point passed the exit signal plus the length of train
$t_{min HT}$	Minimum headway time between two trains
t_{Ot}	On-time threshold (i.e. maximum amount of delay a train service can have and still be regarded as being “on-time”)
t_p	Buffer time
$t_{p.Ex Pt_{S_a}-Pt'_{S_a}}$	Exchange time for passengers from the origin platform track Pt_{S_a} to the objective platform track Pt'_{S_a} in Station S_a
$t_{p.Ex.T_{l_s,i}}^{Pt'_{S_a}}$	Passenger exchange time between the origin platform track to the objective platform track for every affected train $T_{l_s,i}$ within a conflict resolution alternative $RS_{C_f}^y$
t_{PW}	Passengers waiting time at a station induced by the cancellation of train service
$t_{PW,Q-R}^{S_a}$	Transferred passengers' waiting time between the cancelled train service Q and a subsequent trains service R at an affected stations S_a

$t_{PW,RS_{C_f},Q-R}^{S_a}$	Transferred passengers' waiting time between the cancelled train service Q and a subsequent trains service R at an affected stations S_a as part of a conflict resolution alternative RS_{C_f}
$t_{PW,AdjRS_{C_f}}^{S_a}$	Reduction of the transferred passengers' waiting time between the cancelled train service Q and a subsequent trains service R at an affected stations S_a as part of the adjustment of conflict resolution alternative RS_{C_f}
t_{Proj}	Projected arrival, departure or drive-through time of a train
$t_{Proj-Actu}$ situation	Projected arrival, departure or drive-through time of a train during the actual situation
$t_{Proj-Res}$	Projected arrival, departure or drive-through time of a train during the implementation of a conflict resolution alternative
$t_{Proj-T_{l_s,i}}$	Projected arrival, departure or drive-through time of train $T_{l_s,i}$ during the actual situation
$t_{Proj-RS_{C_f}^V-T_{l_s,i}}$	Projected arrival, departure or drive-through time of train $T_{l_s,i}$ during the assessment of a conflict solution alternative $RS_{C_f}^V$
$TR_{Trc_{l_s}}$	Matrix of turn residuals for a conflicting service Trc_{l_s} in the set rc_{l_s}
$TR_{T_{l_s}-Trc_{l_s}}^{TS_{a,l_s}}$	Turn residual for a turn of a train T_{l_s} towards an investigated conflicting train service Trc_{l_s} in the set rc_{l_s} at a turning station TS_a
$TR_{T_{l_s,i}-Q}^{TS_a}$	Turn residual for a turn of a train $T_{l_s,i}$ towards a train service Q at a turning station TS_a
Δt_{Rel}	Relative-time change in the projected movement of a train
TS	Turning Station
TS'_{l_s}	First-order turning station from line l_s
TS''_{l_s}	Second-order turning station from line l_s
$TS_{I_{s,o}}^{dif.}$	Temporal set of differing stations for the PVSCS combination $I_{s,o}$
$t_{SD,\vartheta_{T_{l_s,i}}}$	Time at which vehicle ϑ in the vehicle composition appointed to train $T_{l_s,i}$ started its duties
t_{Stop}	Stopping time of a train
$t_{Stop_{T_{l_s,i}}}^{Pt_{S_a}}$	Stopping time of train $T_{l_s,i}$ at a platform track Pt in station S_a
t_{Sched}	Scheduled arrival, departure or drive-through time of a train

$t_{Sched}^{S_a}$	Scheduled arrival, departure or drive-through time of a train $T_{l_S,i}$ as foreseen in its PVSCS $d_{T_{l_S,i}}$
t_{sicht}	Visibility time
t_{SI}	Service Interval
t_{SI,DRP,l_S}	Service interval for a line l_S according to its DRP operating concept
$t_{SIQ}^{S_a}$	Generated service interval at station S_a due to the cancellation of a train service Q
$t_{SI Trc l_S}^{S_a}$	Generated service interval at station S_a due to the cancellation of a train service generating a reachability conflict on line l_S
$t_{SI,max}$	Maximum service interval
$t_{trans,act}$	Actual transfer time of a train between side
$t_{trans,max}$	Maximum transfer time of a train between sides
t_{Trans}	Transition time between two train services
$t_{Trans}^{Pt S_a}$	Transition time foreseen for train $T_{l_S,i}$ at platform track Pt in station S_a
$t_{Trans.Add}$	Supplement transition time
t_{Turn}	Tuning time of a train (i.e. change of driving direction)
t_{Turn,TS_x}	Turning time at turning station TS_x
$t_{trans,l_S=2-l_S=1}$	Approximate transfer time of trains between sides $l_{S=2} - l_{S=1}$ of the same line l
t_v	Initial delay
t_w	Waiting time of a train
$t_w^{Pt S_a}$	Waiting time of a train $T_{l_S,i}$ at platform track Pt in station S_a
\bar{t}_w	Mean waiting time
$t_w.Adj_{T_{l_S,j}}$	Magnitude of the unnecessary waiting time for train $T_{l_S,j}$
$t_w.RS_{C_f} T_{l_S,j}$	Waiting time appointed to a train $T_{l_S,j}$ by a conflict resolution RS_{C_f}
$t_w.Req_{T_{l_S,j}}$	Necessary waiting time necessary for a train $T_{l_S,j}$ in the actual operating circumstances
t_z	Concatenated occupancy time
$t_{ZK\omega S_a}^{MT_i - MT_j}$	Minimum headway time (i.e. total occupancy time) for switching zone ω in station S_a for a sequence of model trains $MT_i - MT_j$

$t_Z^{Pt_{S_a}}_{MT_i-MT_j}$	Minimum headway time (i.e. total occupancy time) for a platform track Pt in station S_a for a sequence of model trains $MT_i - MT_j$
$t_Z^{Pt_{S_a}}$	Total occupancy time for all trains scheduled to utilize a platform track Pt_{S_a} within a defined time period
$\bar{t}_Z^{Pt_{S_a}}$	Mean occupancy time for all trains scheduled to utilize a platform track Pt_{S_a} within a defined time period
t_0	Deployment time of the dynamic DRP deployment system
$t_{0,TD}$	Deployment time distinguishing the actual time of day $TD \{HVZ, NVZ, SVZ\}$
$t_{0.5}$	Temporal distance in which the function weighs the severity of a conflict half as much as a conflict which occurs simultaneously to the conflict addressed by conflict resolution alternative $RS_{C_f}^\gamma$ under consideration.
$U_{I_{S,o}}$	Total number of entrance sequences for a PVSCS combination $I_{S,o}$
u	Entrance sequence of all potentially queuing trains to the last technically feasible turning station (LtfTS)
V_B	Coefficient of variation of the mean service times
w_i	Weighting parameter for every determining variable DV_i
Y_{l_s}	Set of Yellow clustered trains for line l_s
z	Total occupancy time
z_{haupt}	Occupancy time
z_{vor}	Pre-blocking time
α	Number of PVSCS combinations $I_{S,o}$ to be randomly chosen to implement the tournament selection and establish the bundle of “mating” pairs $\beta_{\delta_v}^\gamma$
δ_v	Set of PVSCS combinations $I_{S,o}$ representing a generation in the Genetic algorithm
$\beta_{\delta_v}^\gamma$	“Mating” pair bundle with a super index γ containing a pair of PVSCS combinations $I_{S,o}$ in generation δ_v
$\varepsilon_{I_{S,o}'}$	Temporal set of operationally incompatible PVSCS during the verification of the operational compatibility of a PVSCS combination $I_{S,o}'$
$\varepsilon'_{I_{S,o}'}$	Temporal set of operationally incompatible PVSCS during the verification of the operational compatibility of a PVSCS combination $I_{S,o}'$ that require to be randomly exchanged
ρ	Capacity consumption
$\rho^{Pt_{S_a}}$	Capacity consumption of a platform track Pt_{S_a}

$\rho_{I_{S,o}}^{Pt_{S_a}}$	Induced capacity consumption of a platform track Pt_{S_a} in station S_a for a PVSCS combination $I_{S,o}$
$\rho_{Sched.}^{Pt_{S_a}}$	Scheduled capacity consumption of a platform track Pt_{S_a} in station S_a
ρ_{Lim}	Recommended limit of capacity consumption
λ	<i>Inter-arrival rate</i>
τ	Total number of trains circulating in the network per side (if applicable)
μ	Service rate
ψ	Cycle variant
ϕ	Iteration in the Tabu Search algorithm
θ^*	Upper bound in the Genetic algorithm for the development of the initial population
ω_{S_a}	Switching zone in station S_a
$\vartheta_{T_{l_{S,i}}}$	Vehicle in the vehicle composition appointed to train $T_{l_{S,i}}$
π	Sequence of projected arrivals of all potentially queuing trains to the last technically feasible turning station (LtfTS)
ΔOS	Change in the projected operating situation during the assessment of a conflict resolution alternative
$\Delta R(I_{S,o})$	Differential in the fitness of a conflict-free PVSCS combination $I_{S,o}$ after its adjustment
$\Delta R(I_{S,o})_{NC_f}$	Differential in the fitness attained by removing an unnecessary measure NC_f from a conflict-free PVSCS combination $I_{S,o}$ during its adjustment
$\Delta RT_{T_{l_{S,i}}}$	Expected relative-time change for train $T_{l_{S,i}}$ during the assessment of a conflict resolution alternative
$\Delta RT_{Circulation}$	Expected relative-time changes for the transition train services appointed in the circulation plan of all directly involved trains during the assessment of a conflict resolution alternative
$\Delta t_{Proj-RS_{C_f}^Y-T_{l_{S,i}}}$	Projected relative-time change for train $T_{l_{S,i}}$ during the assessment of a conflict resolution alternative $RS_{C_f}^Y$
$\Delta t_{Proj-T_{l_{S,i}}}$	Projected relative-time change for train $T_{l_{S,i}}$ during the actual situation

Acronyms and Abbreviations

APCS	Automatic Passenger Counting Systems
ATS	Develop an Alternative Train Service
BT	Bend a Train
CBD	Central Business District
CC	Circulation Conflict
CD	Conflict Identification
CDCR	Conflict Identification and Conflict Resolution
CR	Conflict Resolution
CS	Cancel a Train Service
CT	Coupling a Train
CTS	Cancel a Train Stop
DB	Deutsche Bahn AG
DCT	Decoupling a Train
DRP	Disruption Program
e.g.	exempli gratia – “for example”
ESWE	Verkehrsgesellschaft mbH
etc.	et cetera – “and other similar things”
ETL	Exchange of Trains Between Lines
ETT	Early Turning a Train
FCFS	First Come First Serve
HVV	Hamburger Verkehrsverbund GmbH
HVZ	Peak Hour (in German: Hauptverkehrszeit)
i.e.	id est – “in other words”
IET	Incorporate an External Train
ILP	Integer Linear Programs
LtFTS	Last Technically Feasible Turning Station
LP	Linear Programs
MIP or MILP	Mixed-Integer Linear Programs

NVZ	Off-Peak Hour (in German: Normalverkehrszeit)
OC	Occupancy Conflict
OR	Occupancy Rate
PFV-S	Long-Distance Passenger Service – “Fast”
PFV-L	Long-Distance Passenger Service – “Slow”
PNV-S	Local/Regional Passenger Service – “Fast”
PNV-L	Local/Regional Passenger Service – “Slow”
GV-S	Freight Service – “Fast”
GV-L	Freight Service – “Slow”
PT	Removing and Parking a Train
PVSCS	Potential Vehicle-Specific Conflict Solution in Time and Space
RC	Reachability Conflict
RRT	Reroute a Train
SC	Service Conflict
STT	Shift a Train in Time
SVZ	Off-Peak Hour (in German: Schwachverkehrszeit)
TPW	Transfer Passengers’ Waiting Time
traffiQ	Lokale Nahverkehrsgesellschaft Frankfurt am Main mbH
TS	Tabu Search
TT	Transfer a Train Between Sides
UIC	International Union of Railways
VA	Vehicle Availability Conflict
VDV	Association of German Transport Companies
VVS	Verkehrs- und Tarifverbund Stuttgart GmbH